

# AVENAR panel Serie

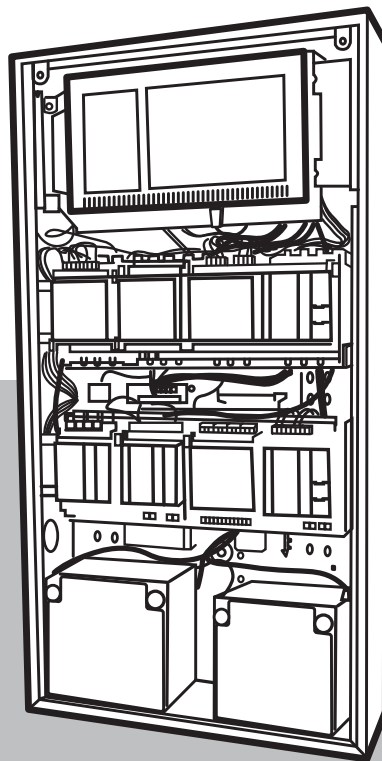



# Inhaltsverzeichnis

<b>1</b>	<b>Hinweise</b>	<b>4</b>
1.1	Inhalt	4
1.2	Produktinformation	5
1.3	Wichtige Hinweise	5
1.4	Benutzerhinweise	5
1.4.1	Kapitelsymbole	7
1.4.2	Anschaltensymbole	7
1.4.3	Stromversorgung und Verkabelung	8
1.5	Widerstandswerte	8
<b>2</b>	<b>Wiring</b>	<b>10</b>
2.1	FPP-5000 Power supply	11
2.2	FPP-3000 Power supply (ZSP135-DR-5A-3/ZSP135-OUT6)	13
2.3	DIBT	15
2.4	Functional Modules	42
2.4.1	BCM-000-B	43
2.4.2	CZM 0004 A	45
2.4.3	ENO 0000 A/B	61
2.4.4	LSN 0300 A	68
2.4.5	NZM 0002 A	106
2.4.6	RMH 0002 A	119
2.4.7	IOS 0020 A	120
2.4.8	FPE-5000-UGM	122
2.5	Interface Modules	124
2.5.1	FLM-420-4/CON-D/S	125
2.5.2	FLM-420-I8R1-S	158
2.5.3	FLM-420-NAC-D/S	160
2.5.4	FLM-420-RHV	172
2.5.5	FLM-420-RLE-S	184
2.5.6	FLM-420-RLV1-E	185
2.5.7	FLM-420-RLV8-S	186
2.5.8	FMF-ADP-FBF/FMF-ADP-TTY	187
2.6	EOL	188
2.6.1	CZM 0004 A	189
2.6.2	LSN 0300 A	201
2.6.3	FLM-420/4-CON-S/D	246
		<b>273</b>

---

# 1 Hinweise

## 1.1 Inhalt

Diese Ansaltehandbuch zeigt, wie Peripheriegeräte grundsätzlich an die Brandmelderzentrale angeschlossen werden. Nationale und lokale Vorschriften werden nicht berücksichtigt. Die Anwendung der nationalen und lokalen Vorschriften können weitere Anschaltungen ermöglichen.

**Hinweis!**

Die in diesem Dokument beschriebenen Anschaltungen gelten auch für AVENAR panel 2000, sofern die einzelnen Komponenten von Bosch Sicherheitssysteme GmbH zugelassene Erweiterungen von AVENAR panel 2000 sind.

**Hinweis!**

Die LSN 0300 A-Anschaltungen in diesem Dokument gelten auch für das LSN 1500 A-Modul. Beachten Sie für das LSN 1500 A-Modul, dass für Installationen in Deutschland, wo die Einhaltung der VdS 2540 gefordert wird, die AUX-Linie und die LSN-Linie in getrennten Kabeln verlegt werden müssen.

---

## 1.2 Produktinformation

- Wie Sie die einzelnen Komponenten der Brandmelderzentrale installieren, entnehmen Sie bitte dem jeweils beigelegten Installationshandbuch.
- Weitere Informationen (Bedienungsanleitungen, Handbuch Vernetzung, Systemhandbuch) finden Sie im Internet unter: [www.boschsecurity.com](http://www.boschsecurity.com)

## 1.3 Wichtige Hinweise

- Nur das von Bosch Sicherheitssysteme empfohlene Montagematerial verwenden.
- Umbau- und Lötarbeiten nur mit Erdungsarmband durchführen!
- Montage und Installation nur durch Fachpersonal!
- Anschlussbedingungen der regionalen Behörden/Institutionen beachten!



### Gefahr!

Lebensgefahr bei Berührung von stromführenden Teilen.  
Vor Installationsarbeiten die Stromzufuhr unterbrechen!

### Schirmbeidraht

Ein Schirmbeidraht ist notwendig für alle 2-Draht-Anschaltungen an CZM 0004 A und für das Anschließen der folgenden Produkte:

- FBF 100 LSN
- FMF-ADP, FMF-FAT, FMF-FBF-FAT, FMF-FIBS-A4, FMF-FIBS-A3

Die folgende Beispielanschaltung zeigt wie ein Schirmbeidraht aufgelegt wird.

### Hinweis!

Wenn ein Schirmbeidraht für das LSN-Kabel verbunden werden muss, verfahren Sie gemäß der LSN-Spezifikationen.

- Verbinden Sie den LSN-Schirmbeidraht zentralenseitig mit der vorgesehenen funktionalen Erde:

zwei Anschlüsse am Anfang und am Ende eines Rings

ein Anschluss am Anfang eines Sticks

- Den Schirmbeidraht an allen LSN-Peripheriegeräten durchschleifen, dabei die vorgesehenen Klemmen verwenden.

- Es ist keine weitere Verbindung des LSN-Schirmbeidrahts zuässig, weder zu anderen Erdanschlüssen, noch zu einem anderen elektrischen Potenzial.



## 1.4 Benutzerhinweise

Das Ansaltehandbuch ist wie folgt strukturiert:

- Das Kapitel Anschaltung ist nach dem Gerät sortiert, an das ein Peripheriegerät angeschlossen wird. Eine Anschaltung zeigt die direkte Verbindung eines Geräts mit einem anderen (keine kaskadierenden Verbindungen).
- Eine Sammlung aller Anschaltungen, die mit zusätzlichen EOL-Modulen für die Überwachung von schleichender Unterbrechung versehen sind, finden Sie in Abschnitt EOL.

Verwenden Sie zum Suchen einer benötigten Anschaltung auch:





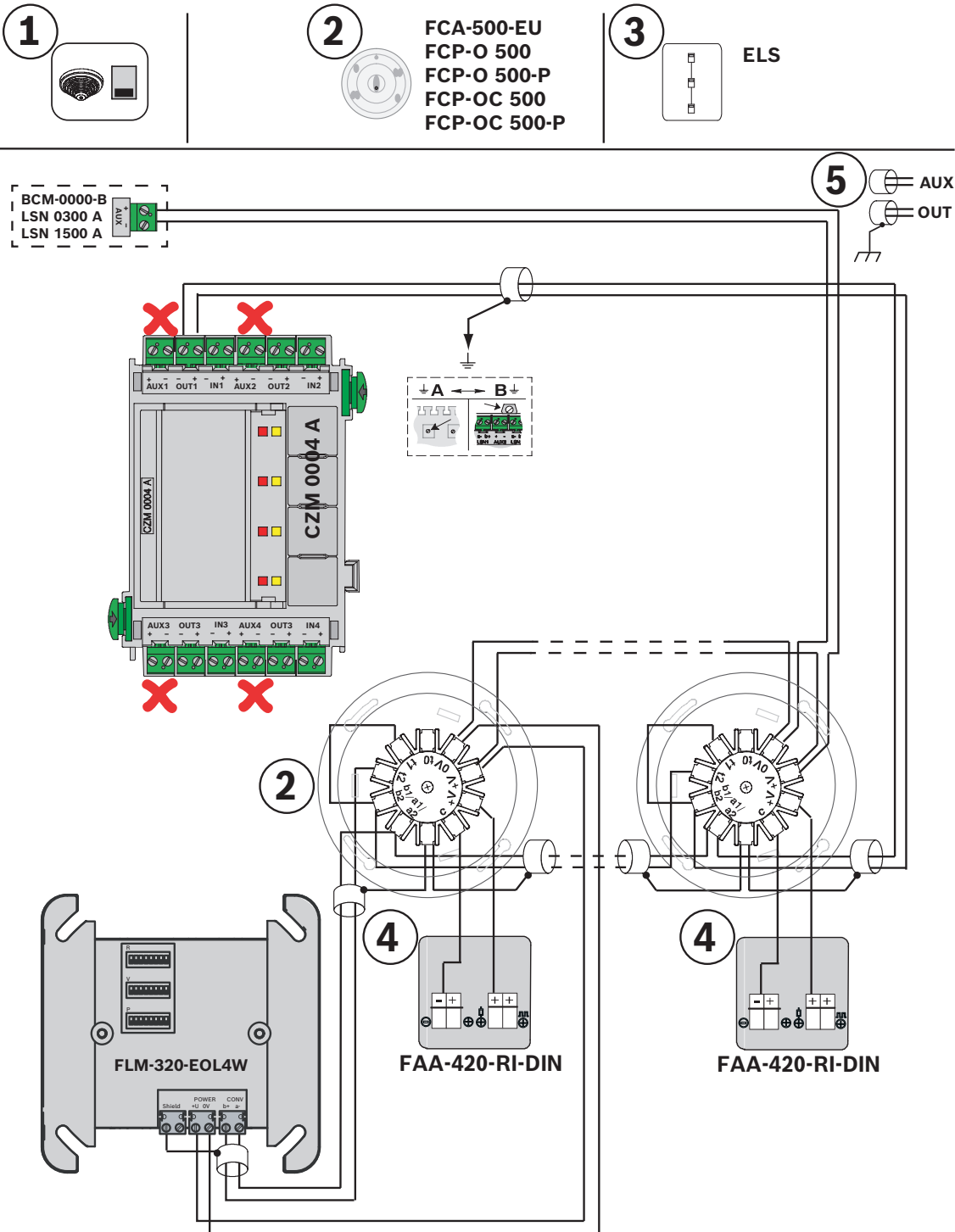







- das Inhaltsverzeichnis am Anfang des Kapitels Anschaltung und am Anfang der Abschnitte Funktionsmodule, Koppler und EOL.
- den Index (sprachneutral),
- und die Volltextsuche.

Siehe die folgende Beispielanschaltung:













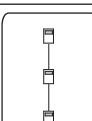
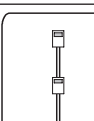
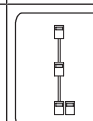
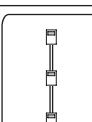

1	Kapitelsymbole ( <i>Kapitelsymbole, Seite 7</i> )
2	Anschaltbares Peripheriegerät
3	Anschaltessymbole ( <i>Anschaltessymbole, Seite 7</i> )
4	Optionale Komponenten
5	Stromversorgung und Anschaltung ( <i>Stromversorgung und Verkabelung, Seite 8</i> )

### 1.4.1 Kapitelsymbole



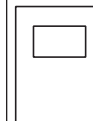

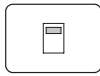
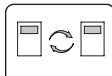
	Automatische Melder		Bedien- und Anzeigetableaus		Drucker
	Stromversorgung		Funktionsmodule		Feuerwehreinrichtungen
	Koppler		Löschanlagen		Manuelle Melder
	Signalgeber		Türsteuerungen		Übertragungseinrichtungen

### 1.4.2 Anschaltesymbole

	Verpflichtende Verkabelung		Optionale Verkabelung		Nicht zulässig
	Redundanz		Ringverdrahtung		Ringverdrahtung mit redundantem Element
	Stichverdrahtung		Redundante Stichverdrahtung		Stichverdrahtung mit redundantem Element
	Redundante Stichverdrahtung mit redundantem Element	ELS	Diese Verdrahtung entspricht VdS 2489 / VdS 2540 / VdS 2541 / VdS 2543. ELS steht für Erweiterte Leitungsüberwachung, d. h. Überwachung auf schleichenden Kurzschluss und schleichende Unterbrechung. Diese Anschaltung bietet ELS. Ein schleichender Kurzschluss wird von den folgenden Modulen erkannt: LSN 0300 A, LSN 1500 A und BCM-0000-B bei Verwendung von FPP-5000-TI13.		Diese Ringverdrahtung entspricht VdS 2489 / VdS 2540 / VdS 2541 / VdS 2543. Sie bietet ELS. Weitere EOL-Module sind nicht erforderlich.
	Synchronisierung		Explosionsgefährdeter Bereich		Zentrale

	Stand-Alone-Zentrale		Stand-Alone-Zentrale mit Redundanz		Für Meldersockel: Die Verdrahtung ist nur für den Meldersockel gültig, in dem der Melder installiert ist.
EN 54-2, DIBT etc.	Wenn diese Norm gefordert ist, verwenden Sie diese Anschaltung.				

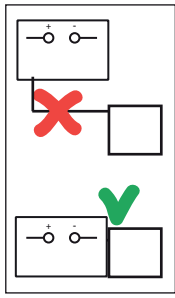
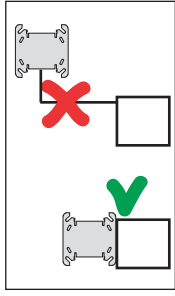
### 1.4.3 Stromversorgung und Verkabelung

	Kabel, zweiadrig ist erforderlich.
	Geschirmtes Kabel, zweiadrig ist erforderlich.
	Das Element muss bündig mit dem Gehäuse des Produkts montiert werden, das die Stromversorgung enthält.
	Bündige Montage des Kopplers ist erforderlich.
 <b>Reset action</b>	Siehe Anschaltung in diesem Handbuch. Für automatisches Rücksetzen des Geräts müssen Sie diese Reset-Schaltung implementieren.

### 1.5 Widerstandswerte

Die folgende Tabelle gibt Ihnen einen Überblick über die Farbcodierung von Widerständen. Die mitgelieferten Metallschichtwiderstände haben fünf farbige Streifen, anhand derer Sie den Widerstandswert ablesen können.

Farbe	1. Streifen	2. Streifen	3. Streifen	4. Streifen (Multiplikator)	5. Streifen (Grenzabweichung)
Silber				10 <sup>-2</sup>	±10%
Gold				10 <sup>-1</sup>	±5%
Schwarz		0	0	10 <sup>0</sup>	



Farbe	1. Streifen	2. Streifen	3. Streifen	4. Streifen (Multiplikator)	5. Streifen (Grenzabweichung)
Braun	1	1	1	10 <sup>1</sup>	±1%
Rot	2	2	2	10 <sup>2</sup>	±2%
Orange	3	3	3	10 <sup>3</sup>	±0.05%
Gelb	4	4	4	10 <sup>4</sup>	±0.02%
Grün	5	5	5	10 <sup>5</sup>	±0.5%
Blau	6	6	6	10 <sup>6</sup>	±0.25%
Violett	7	7	7	10 <sup>7</sup>	±0.1%
Grau	8	8	8	10 <sup>8</sup>	±0.01%
Weiß	9	9	9	10 <sup>9</sup>	

Gemäß DIN EN 60062:2017

*Orange – Weiß – Schwarz – Braun – Braun*: 3,9 kOhm Widerstand mit 1 % Toleranz,

*Rot – Rot – Schwarz – Braun – Braun*: 2,2 kOhm Widerstand mit 1 % Toleranz.

## 2 Wiring



*FPP-5000 Power supply, Seite 11*

*FPP-3000 Power supply (ZSP135-DR-5A-3/ZSP135-OUT6), Seite 13*

*DIBT, Seite 15*

*Functional Modules, Seite 42*

*BCM-000-B, Seite 43*

*CZM 0004 A, Seite 45*

*ENO 0000 A/B, Seite 61*

*LSN 0300 A, Seite 68*

*NZM 0002 A, Seite 106*

*RMH 0002 A, Seite 119*

*IOS 0020 A, Seite 120*

*FPE-5000-UGM, Seite 122*

*Interface Modules, Seite 124*

*FLM-420-4/CON-D/S, Seite 125*

*FLM-420-I8R1-S, Seite 158*

*FLM-420-NAC-D/S, Seite 160*

*FLM-420-RHV, Seite 172*

*FLM-420-RLE-S, Seite 184*

*FLM-420-RLV1-E, Seite 185*

*FLM-420-RLV8-S, Seite 186*

*FMF-ADP-FBF/FMF-ADP-TTY, Seite 187*

*EOL, Seite 188*

*CZM 0004 A, Seite 189*

*LSN 0300 A, Seite 201*

*FLM-420/4-CON-S/D, Seite 246*

## 2.1 FPP-5000 Power supply

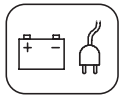

FPP-5000-TI

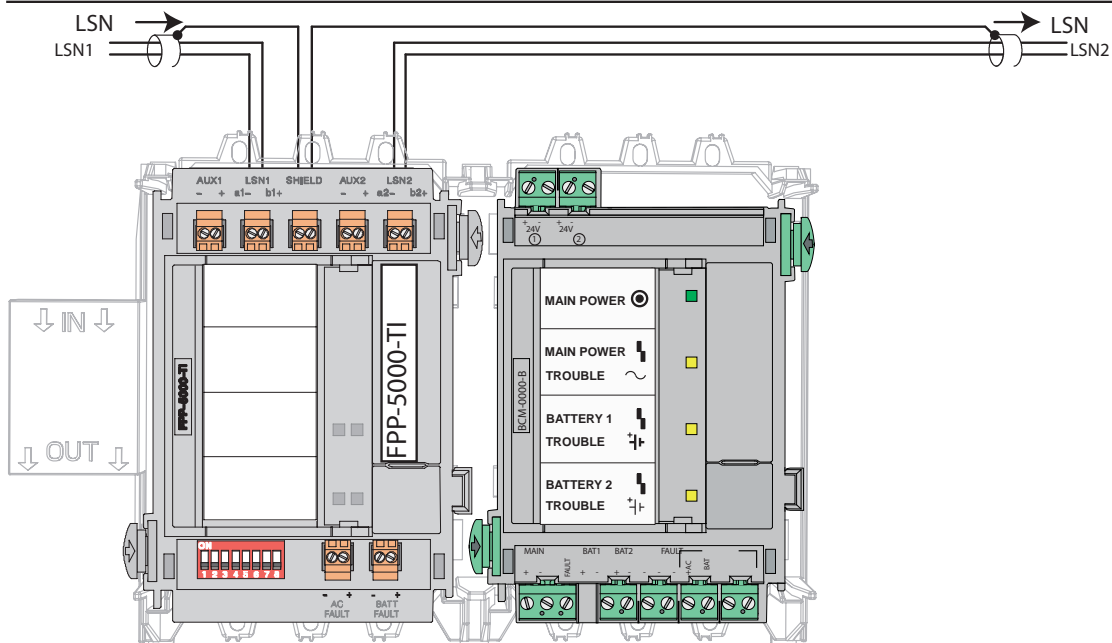

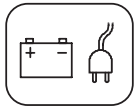

FPP-5000-TI13

ELS

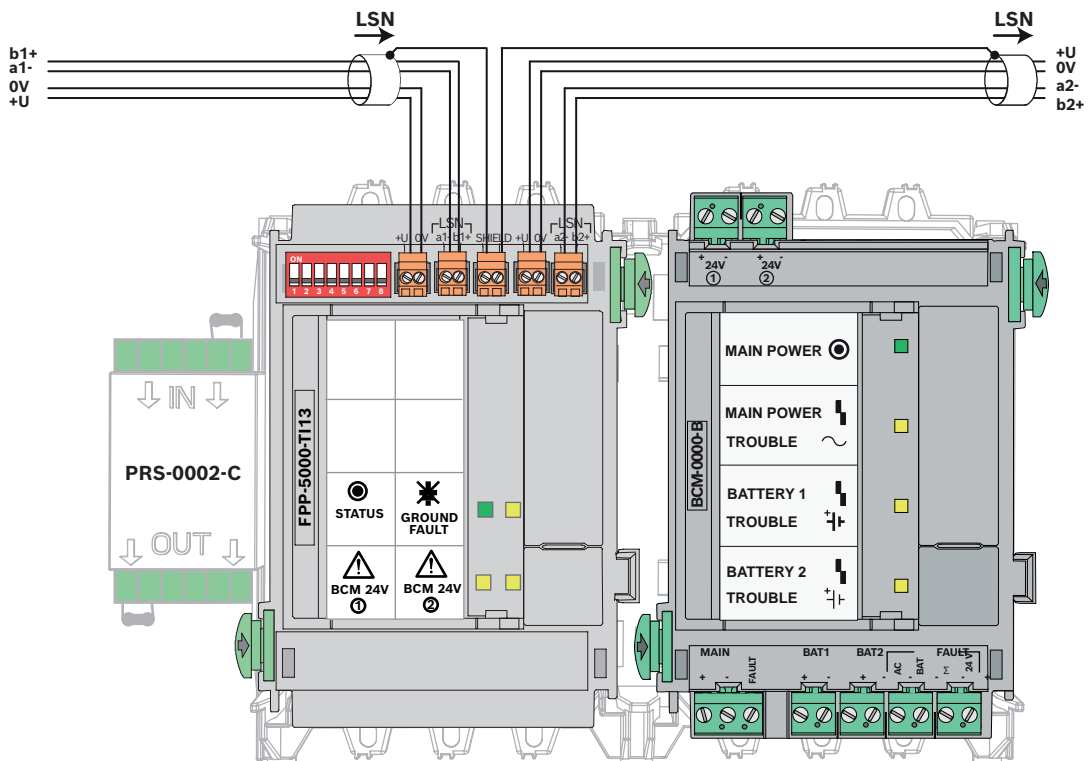



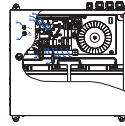
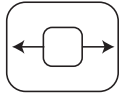

ZSP135-DR-5A-3  
ZSP135-OUT6  
FPP-3000

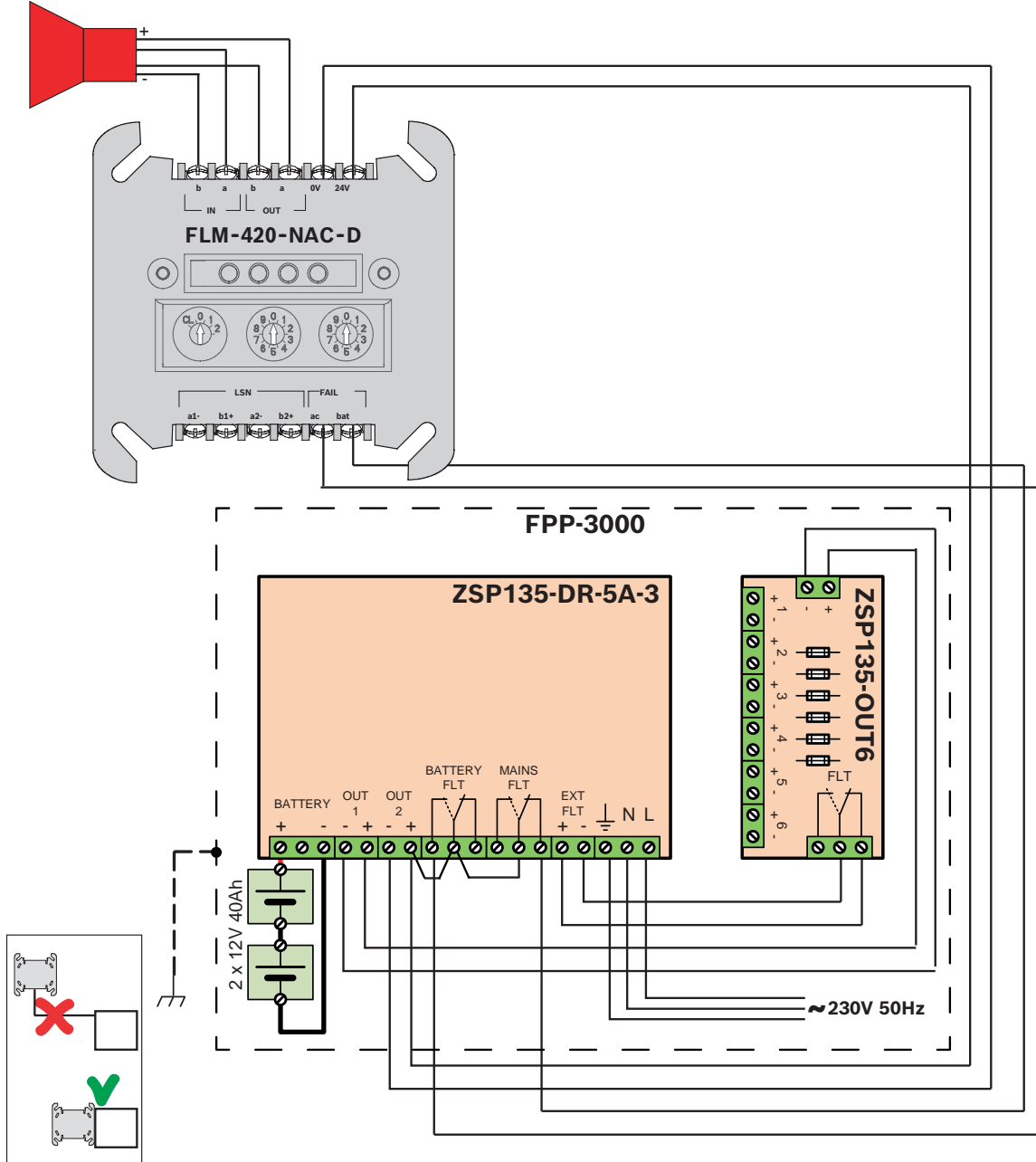

### 2.3

### DIBT

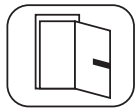

**ED 100  
ED 250  
(+Upgrade Card B)**

**DIBT**

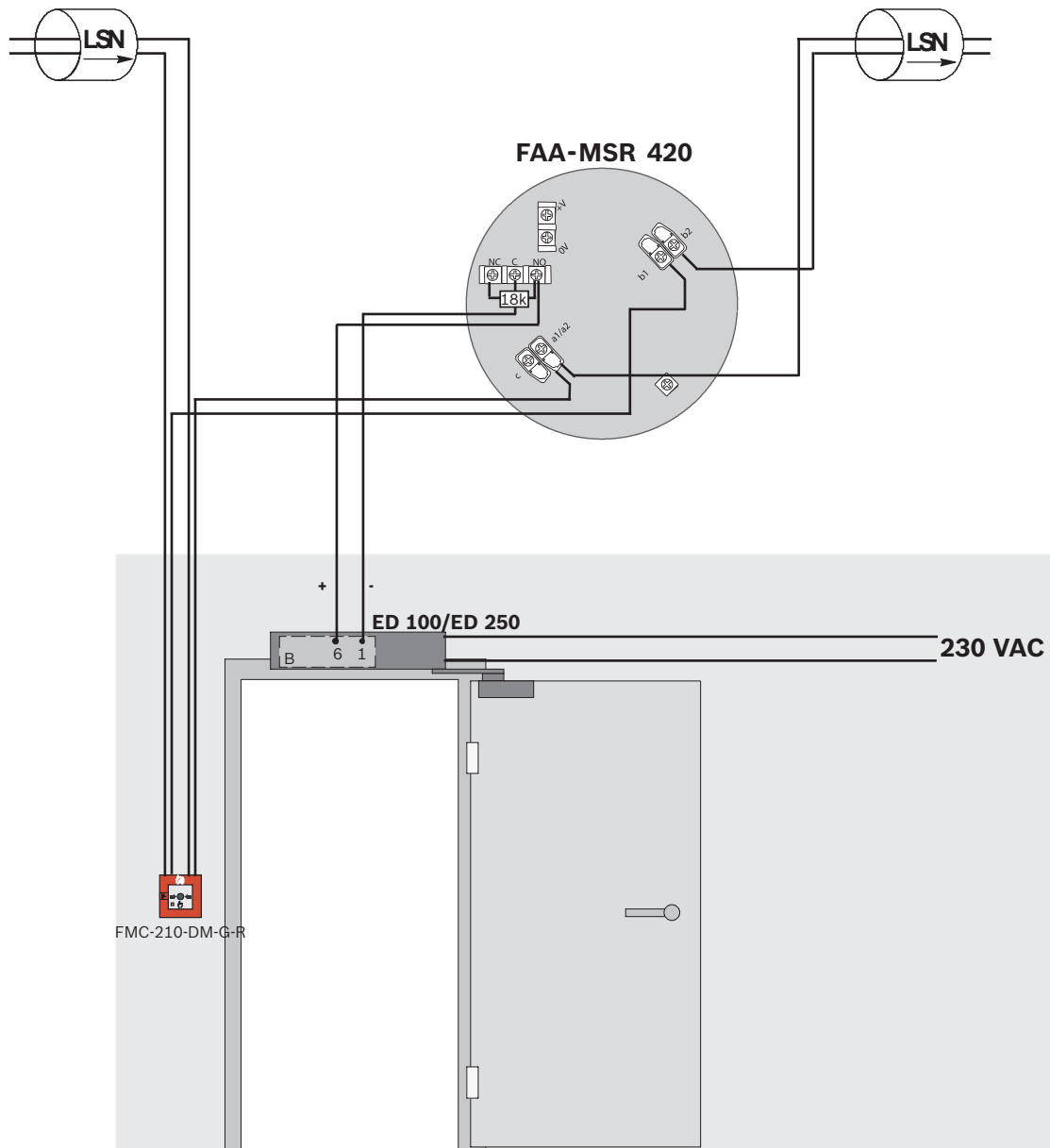



**ED 100  
ED 250  
(+Upgrade Card B)**

**DIBT**

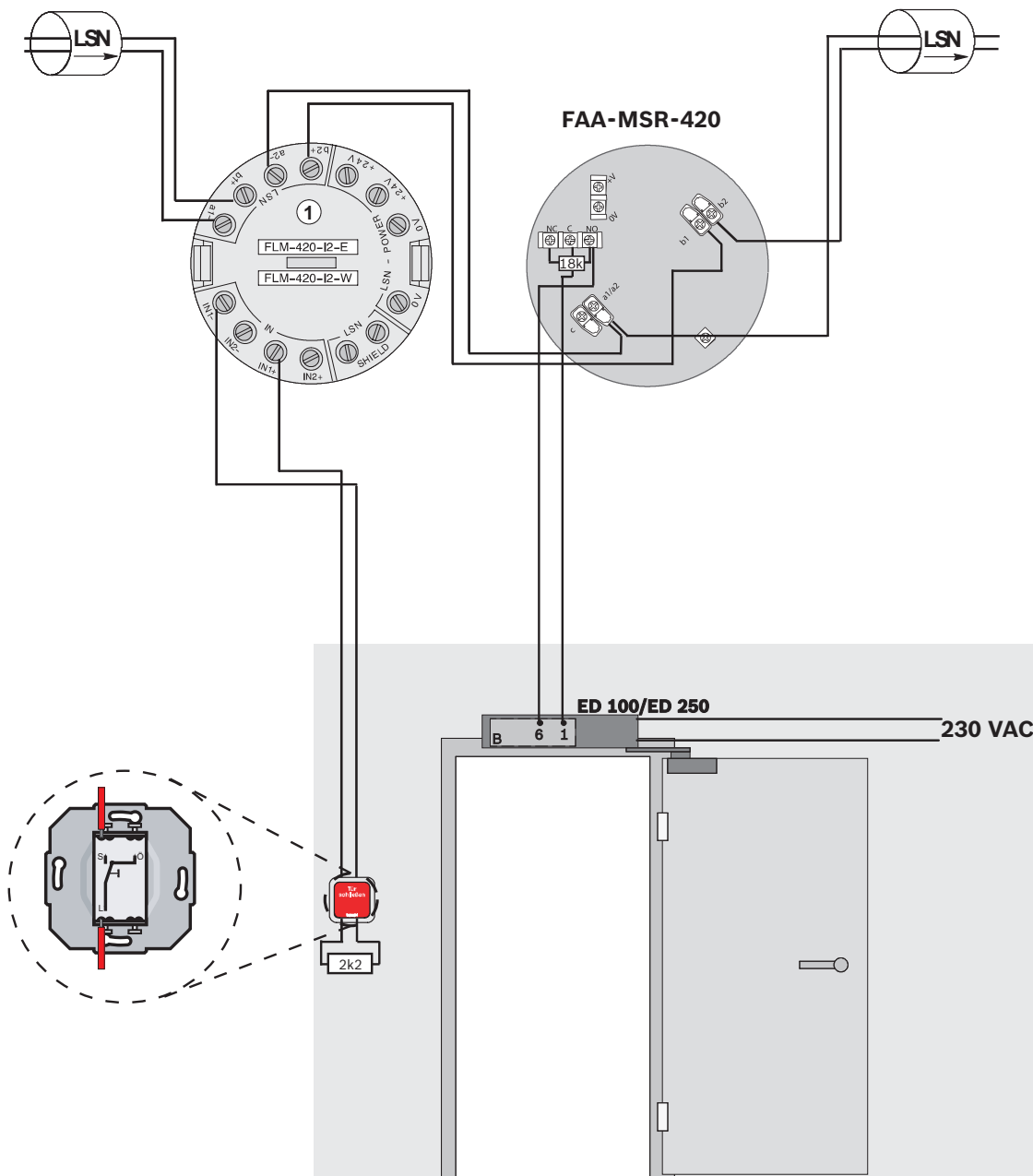



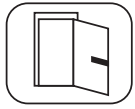

GT xx R  
8 xx

DIBT

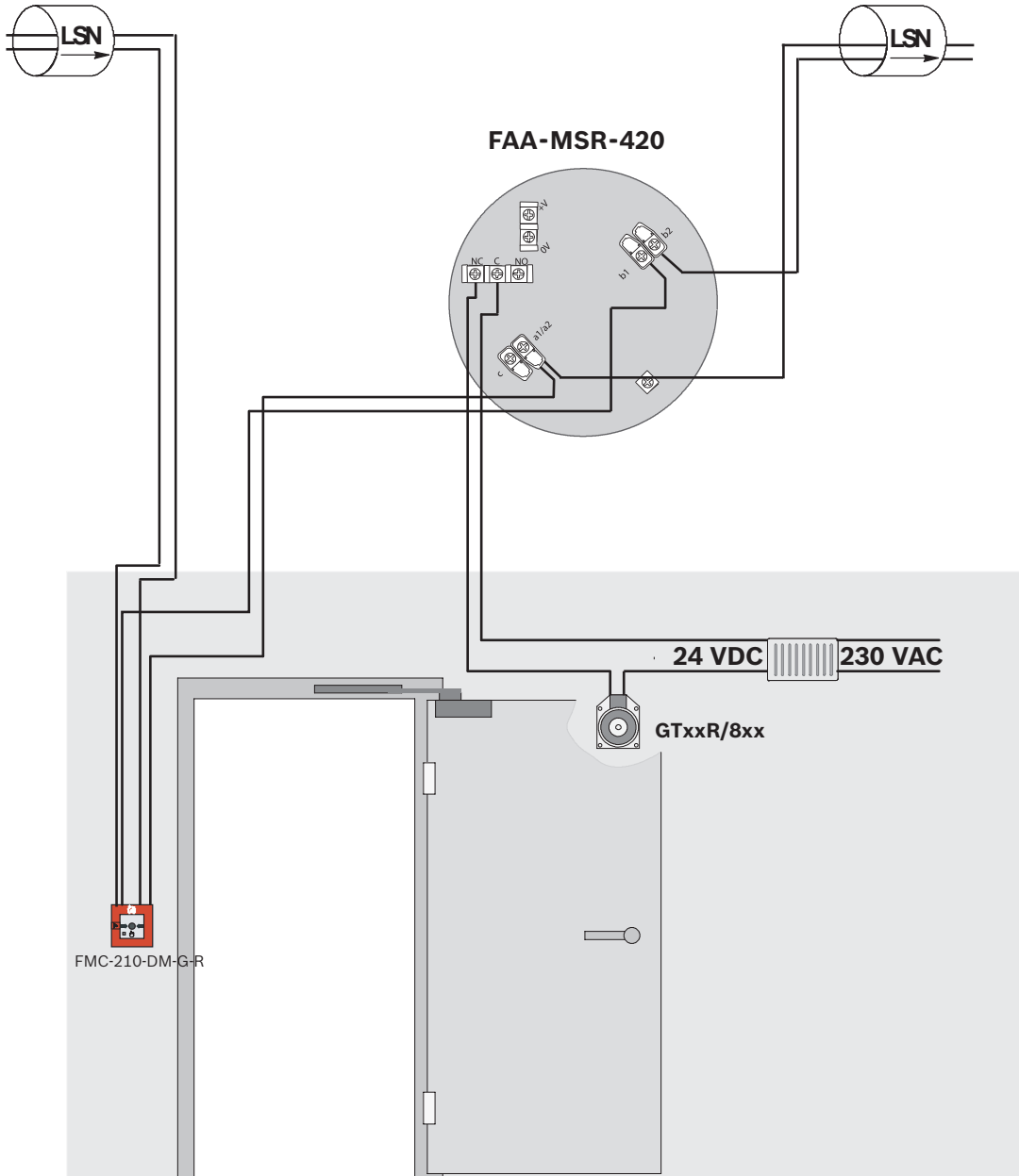

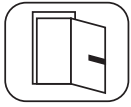

GT xx R

8 xx

DIBT

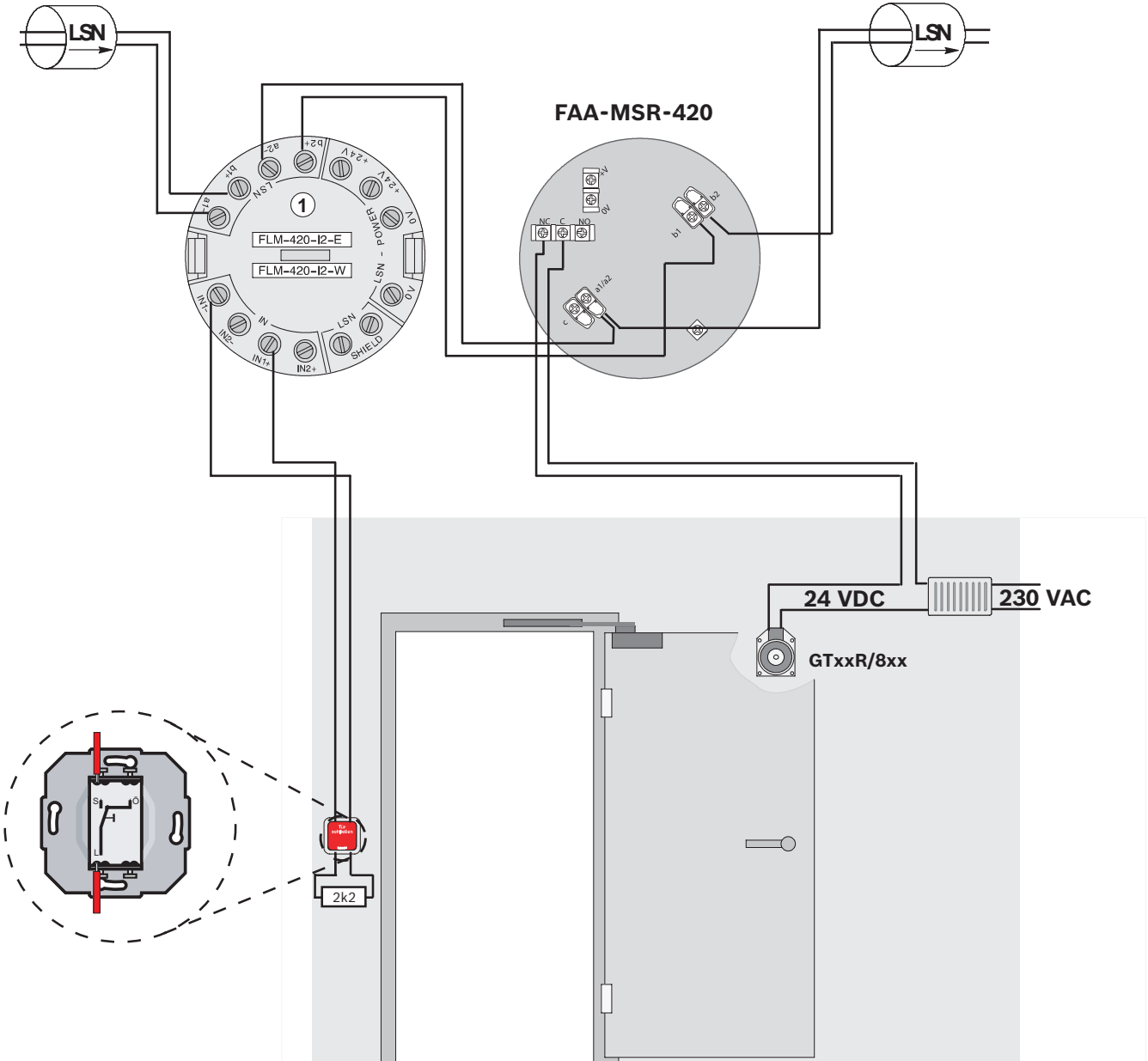

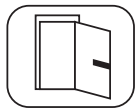

TS 73 EMF  
 TS 93 EMF  
 TS 93 GSR  
 BTS 80 EMB  
 BTS 80 FLB

**DIBT**

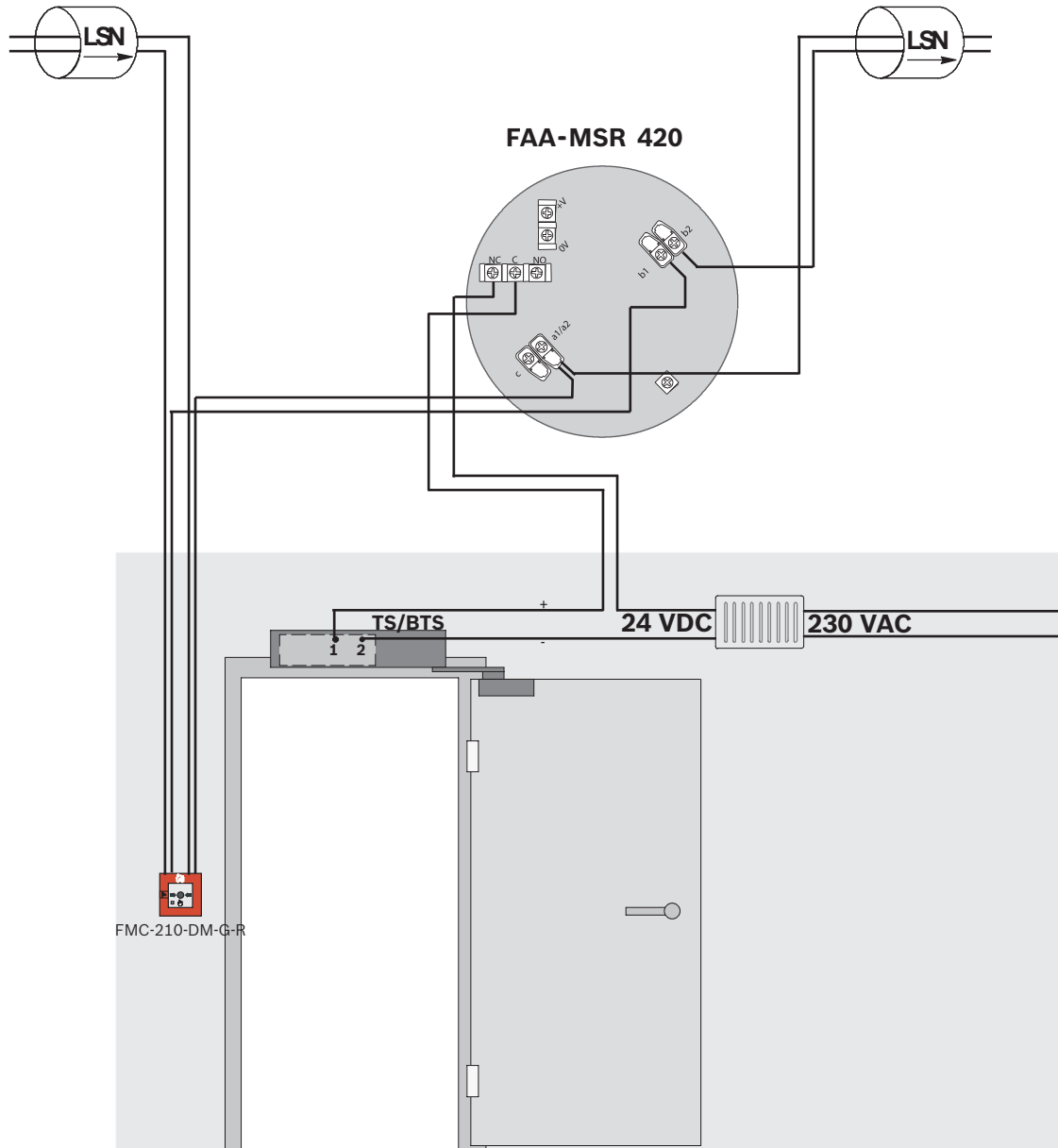

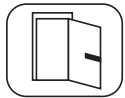

TS 73 EMF  
 TS 93 EMF  
 TS 93 GSR  
 BTS 80 EMB  
 BTS 80 FLB

DIBT

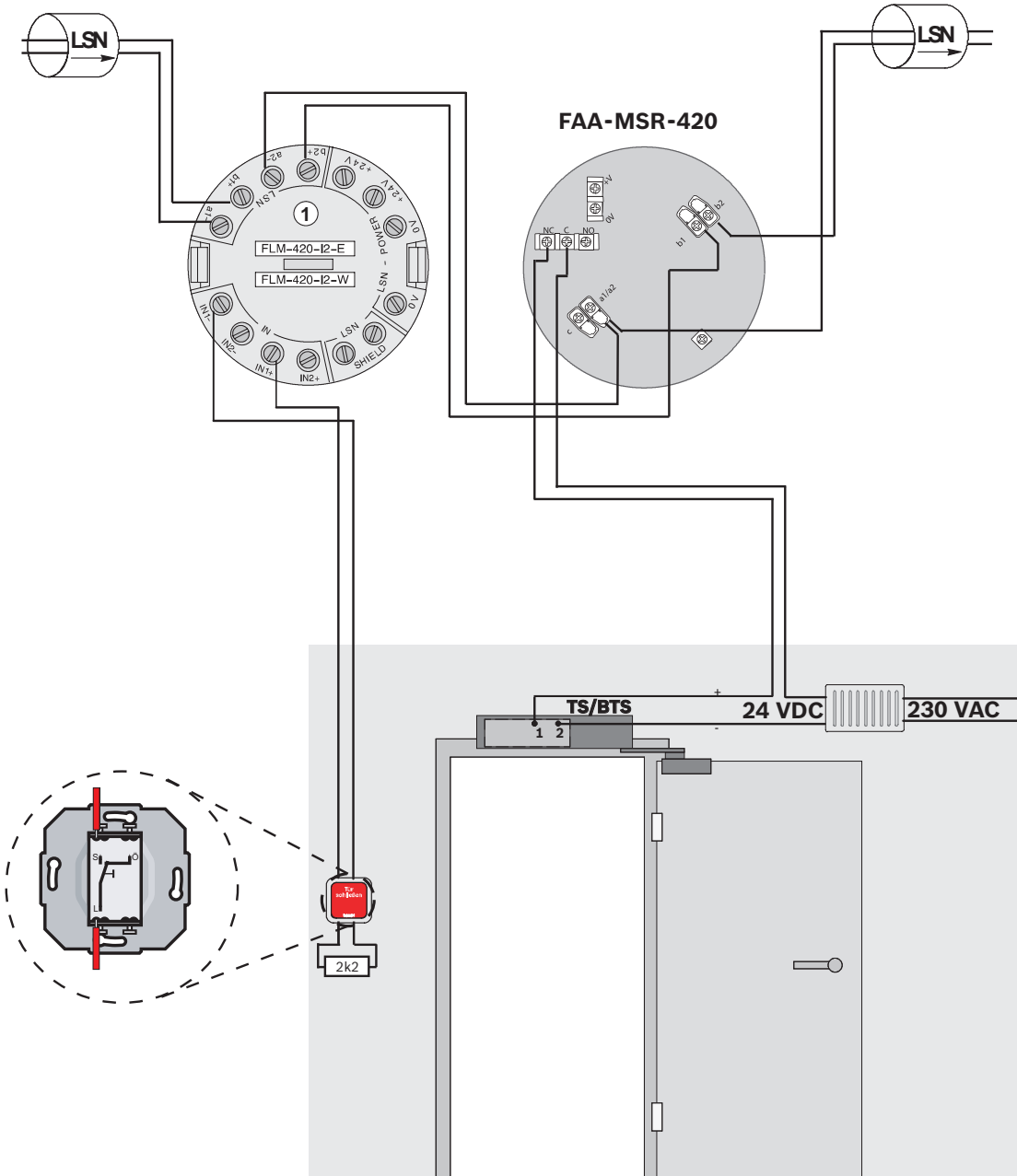

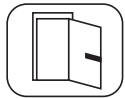

Slimdrive EMD-F/EMD F-IS

DIBT

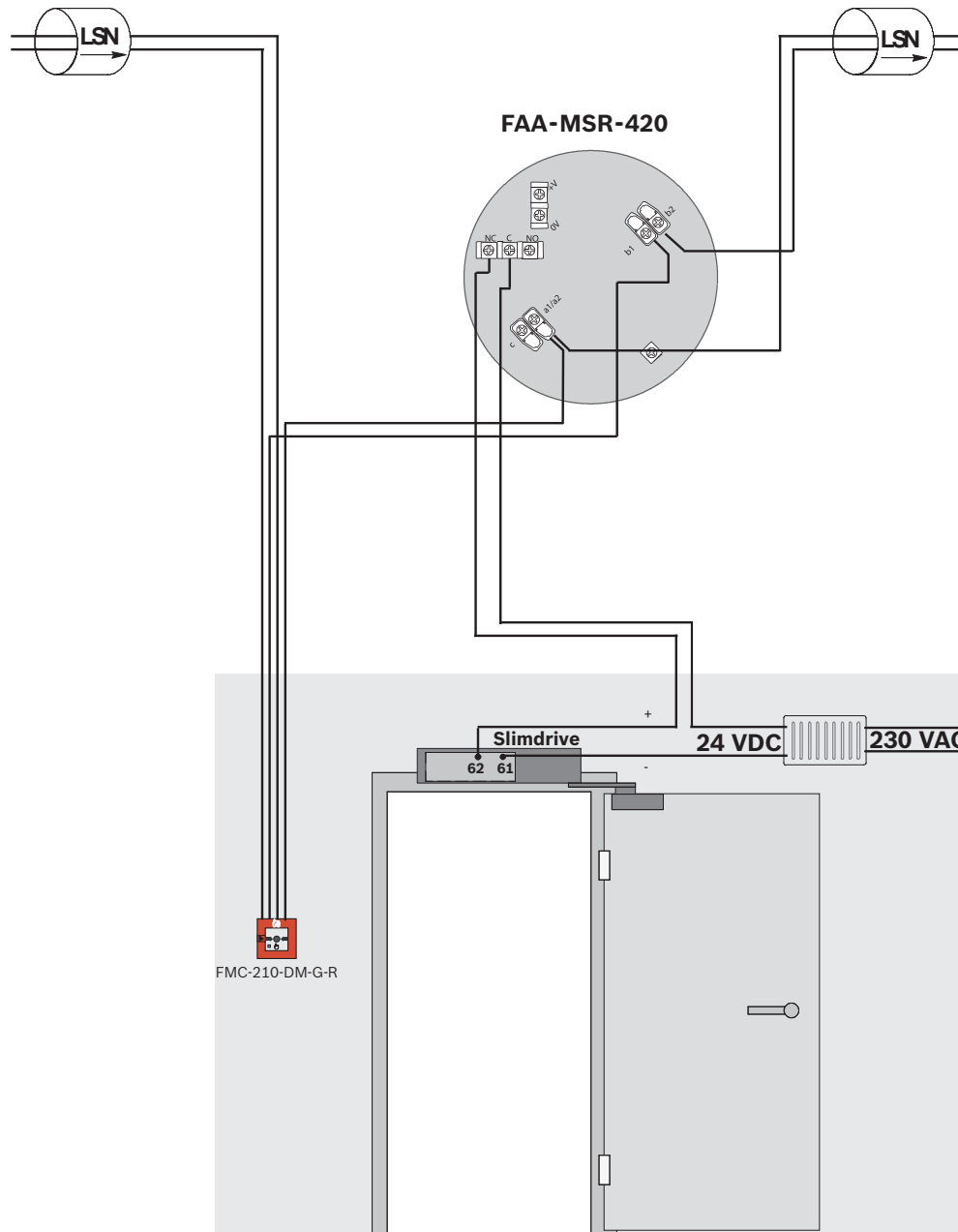



Slimdrive EMD-F/EMD F-IS

DIBT

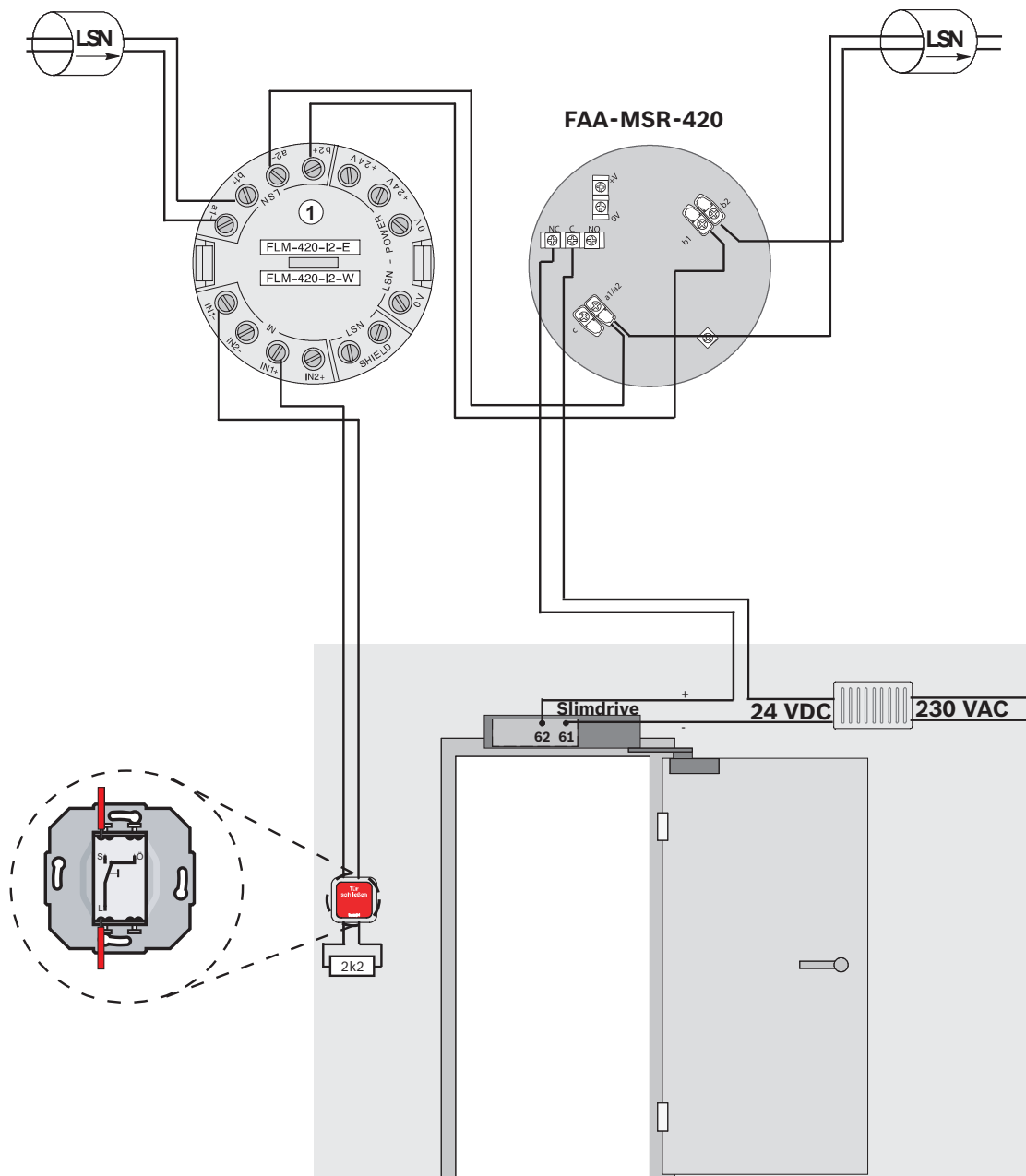

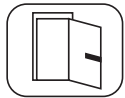

TS 4000 E/E-IS/EFS  
 TS 5000 E/E-IS/E-ISM  
 TS 550 E  
 TSA 160 NT F/F-IS/F-IS/TS

DIBT

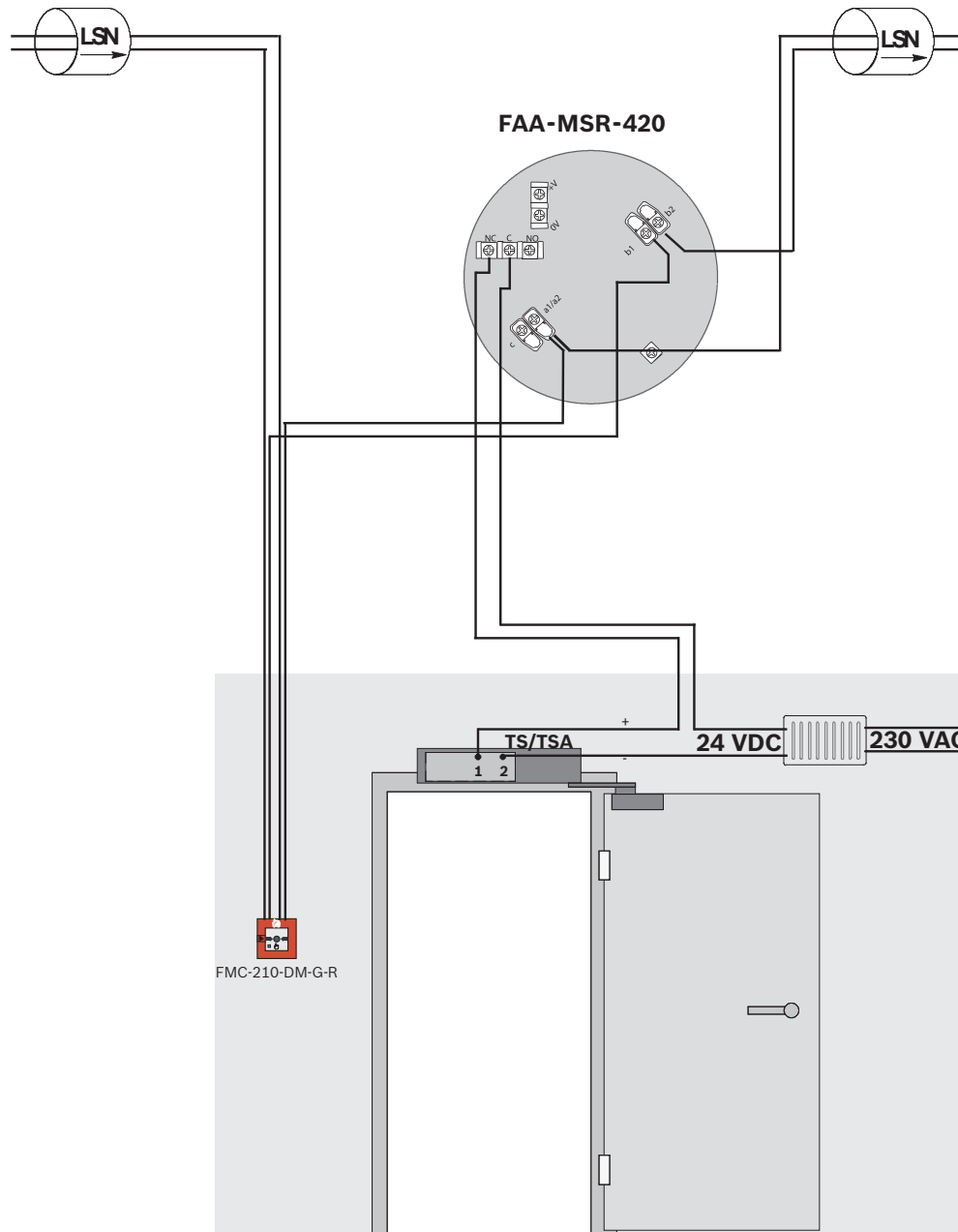

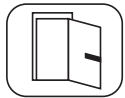

TS 4000 E/E-IS/EFS  
 TS 5000 E/E-IS/E-ISM  
 TS 550 E  
 TSA 160 NT F/F-IS/F-IS/TS

DIBT

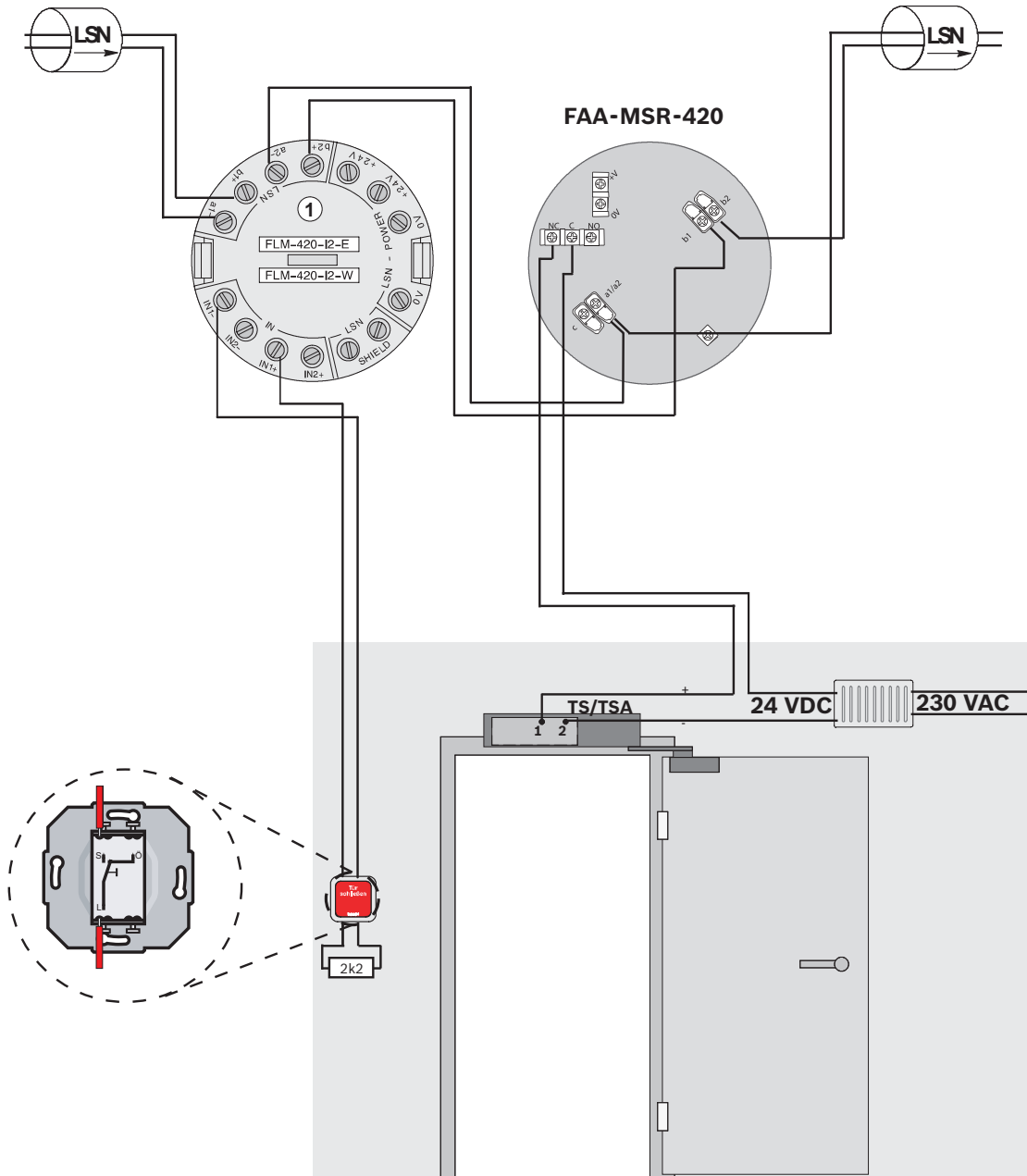



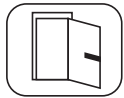

**ED 100  
ED 250  
(+Upgrade Card B**

**DIBT**

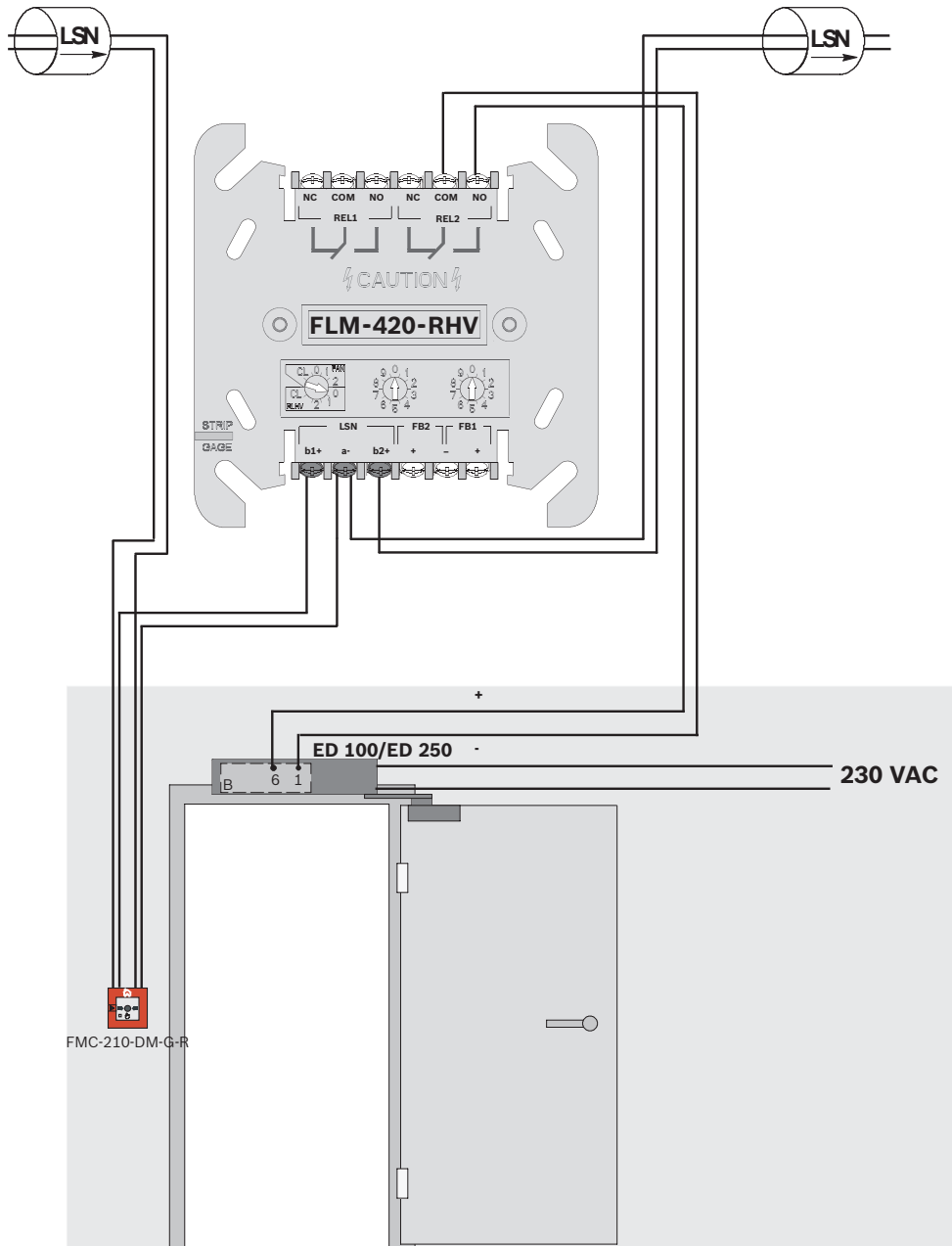



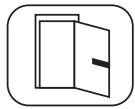

GT xx R

8 xx

DIBT

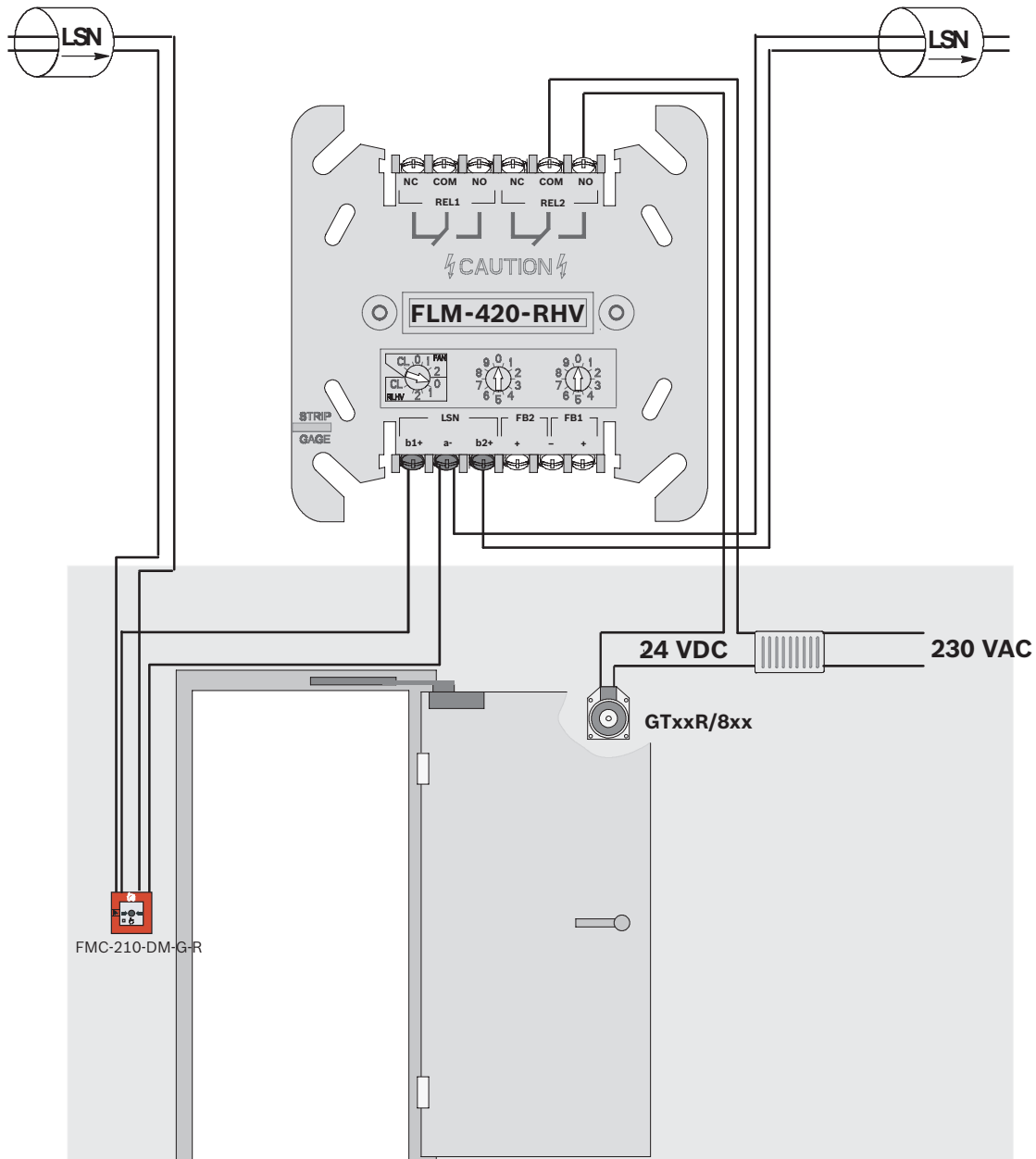

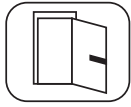

GT xx R  
8 xx

DIBT

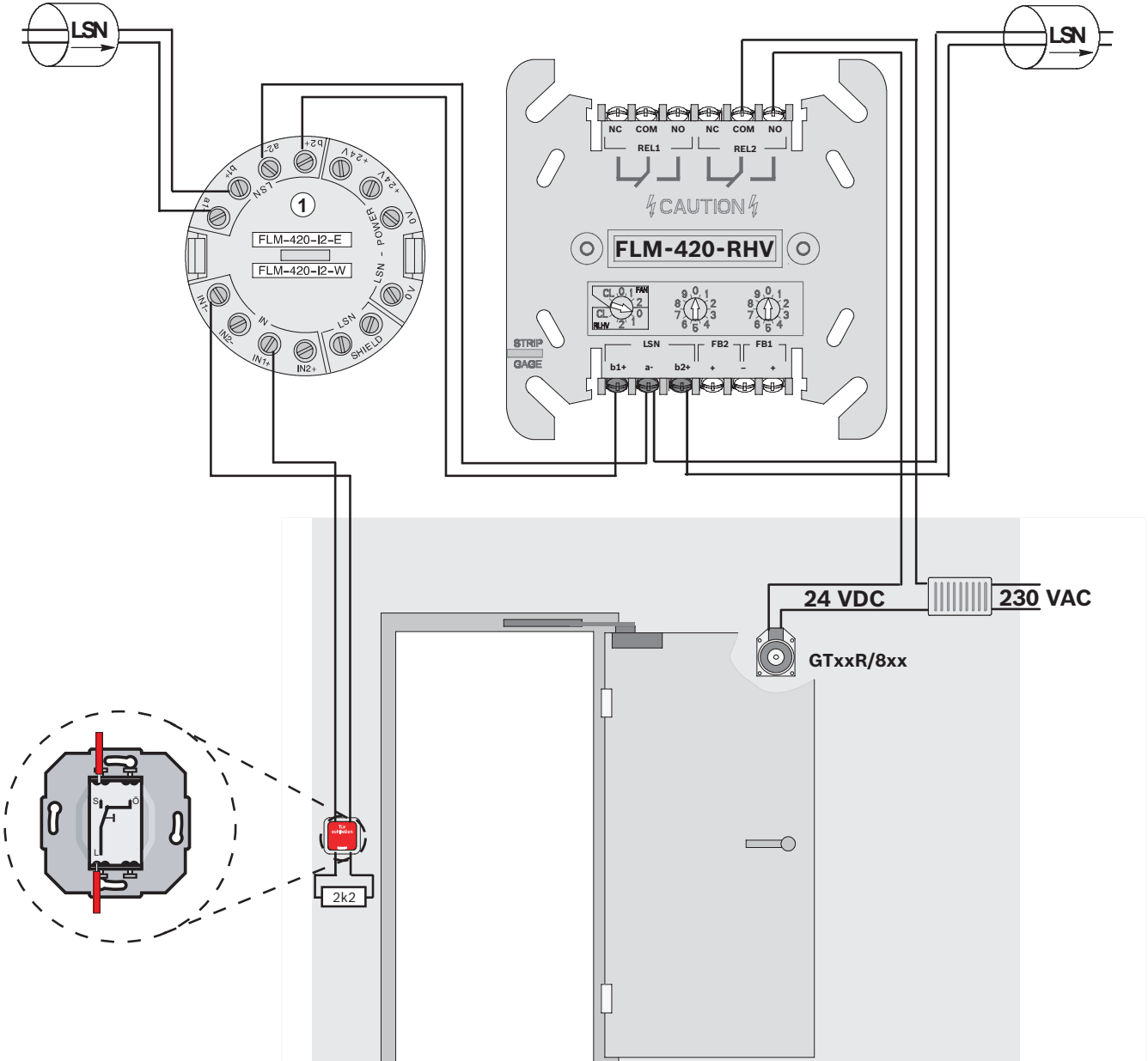

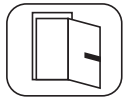

TS 73 EMF  
 TS 93 EMF  
 TS 93 GSR  
 BTS 80 EMB  
 BTS 80 FLB

DIBT

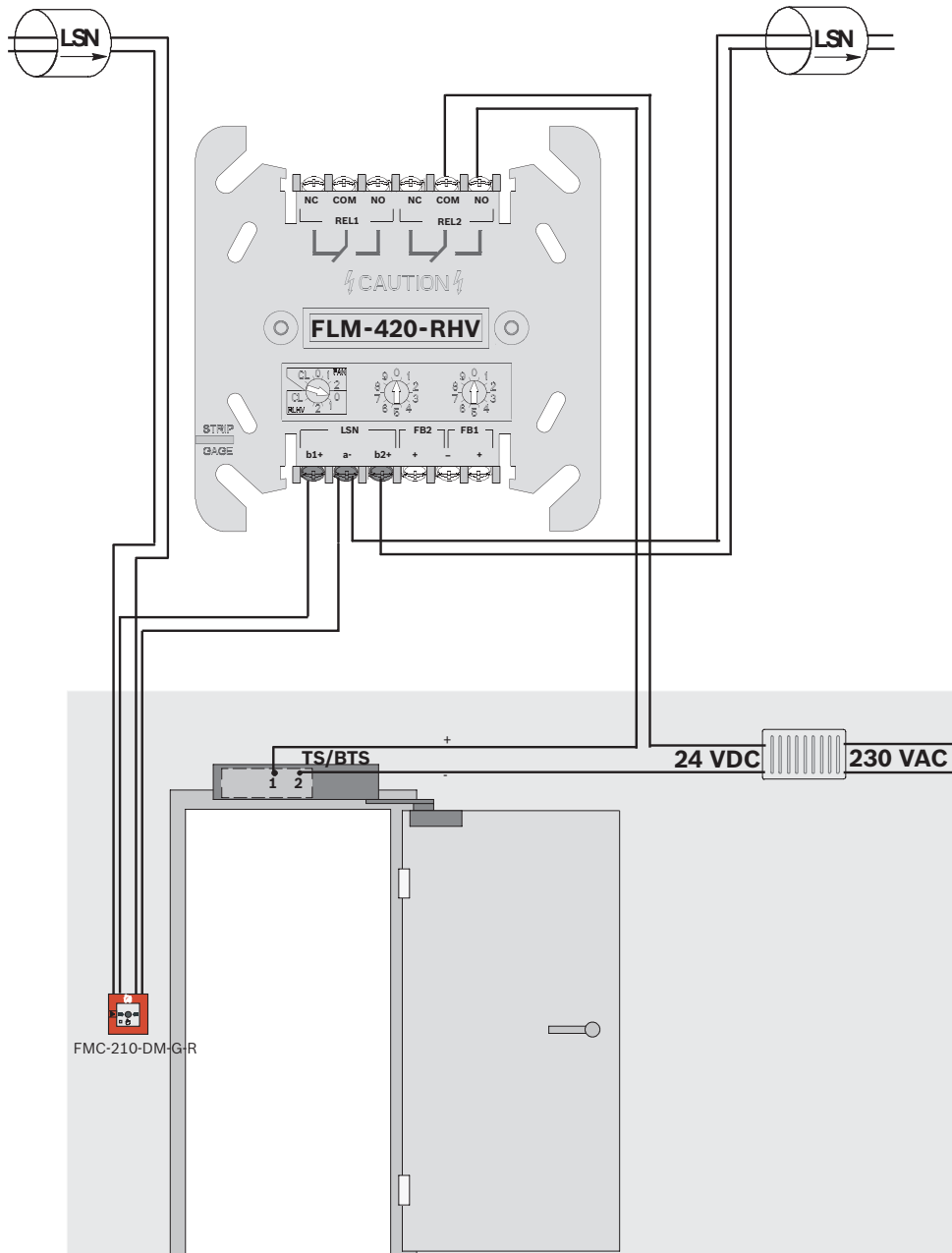



TS 73 EMF  
 TS 93 EMF  
 TS 93 GSR  
 BTS 80 EMB  
 BTS 80 FLB

DIBT

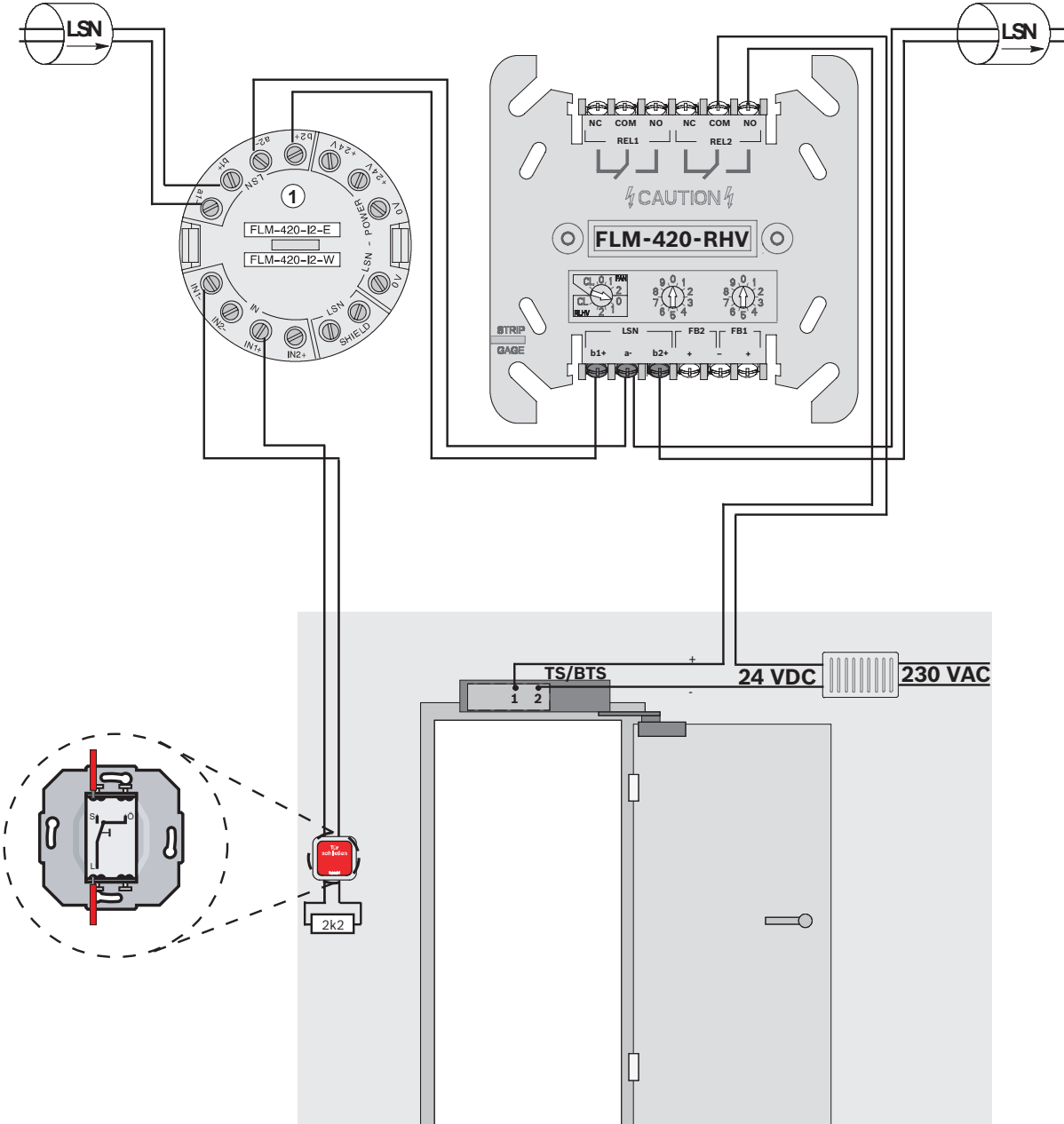

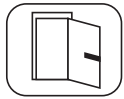

Slimdrive EMD-F/EMD F-IS

DIBT

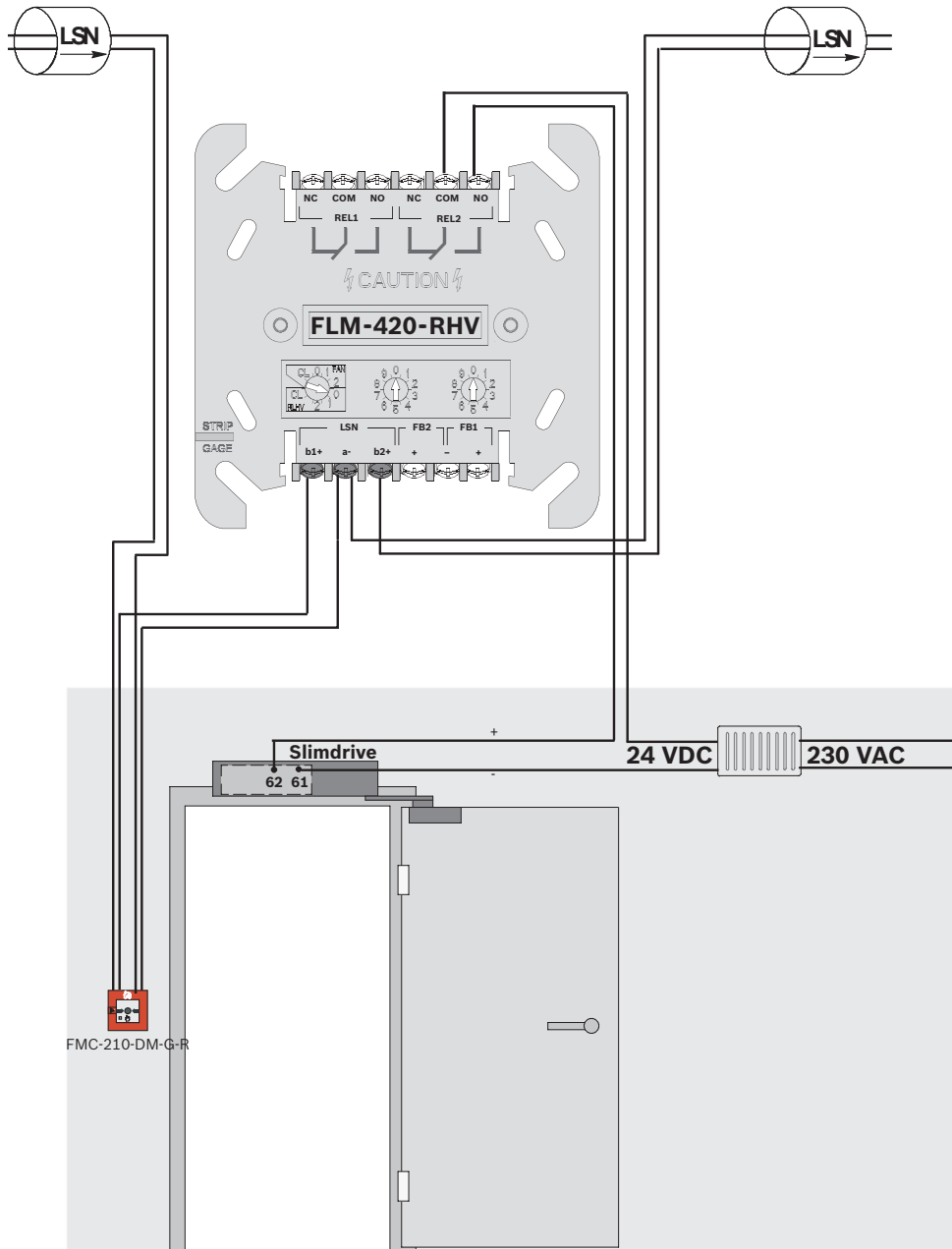

FMC-210-DM-G-R



Slimdrive EMD-F/EMD F-IS

DIBT

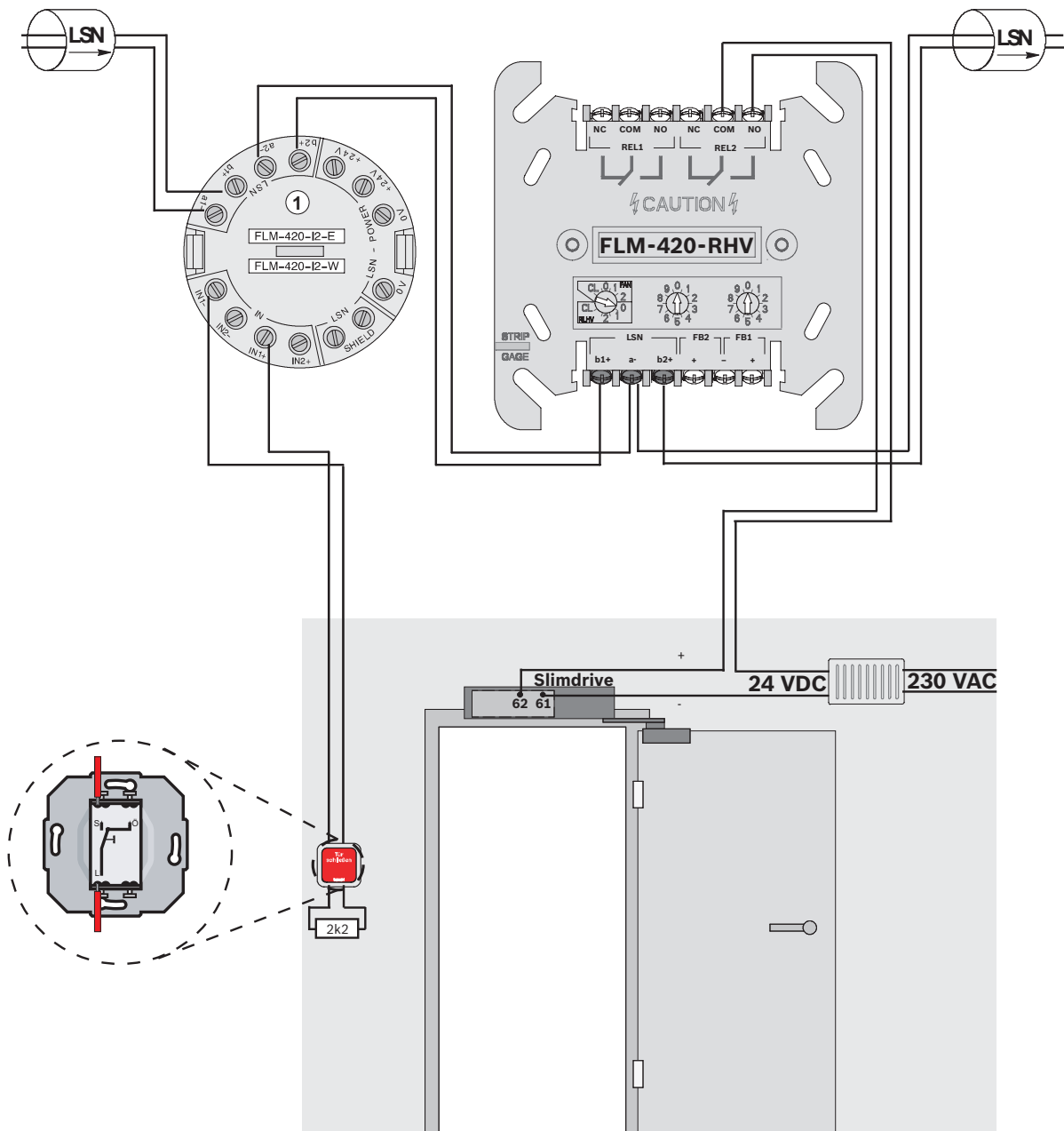



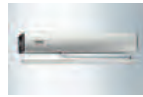
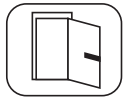

TS 4000 E/E-IS/EFS  
 TS 5000 E/E-IS/E-ISM  
 TS 550 E  
 TSA 160 NT F/F-IS/F-IS/TS

DIBT

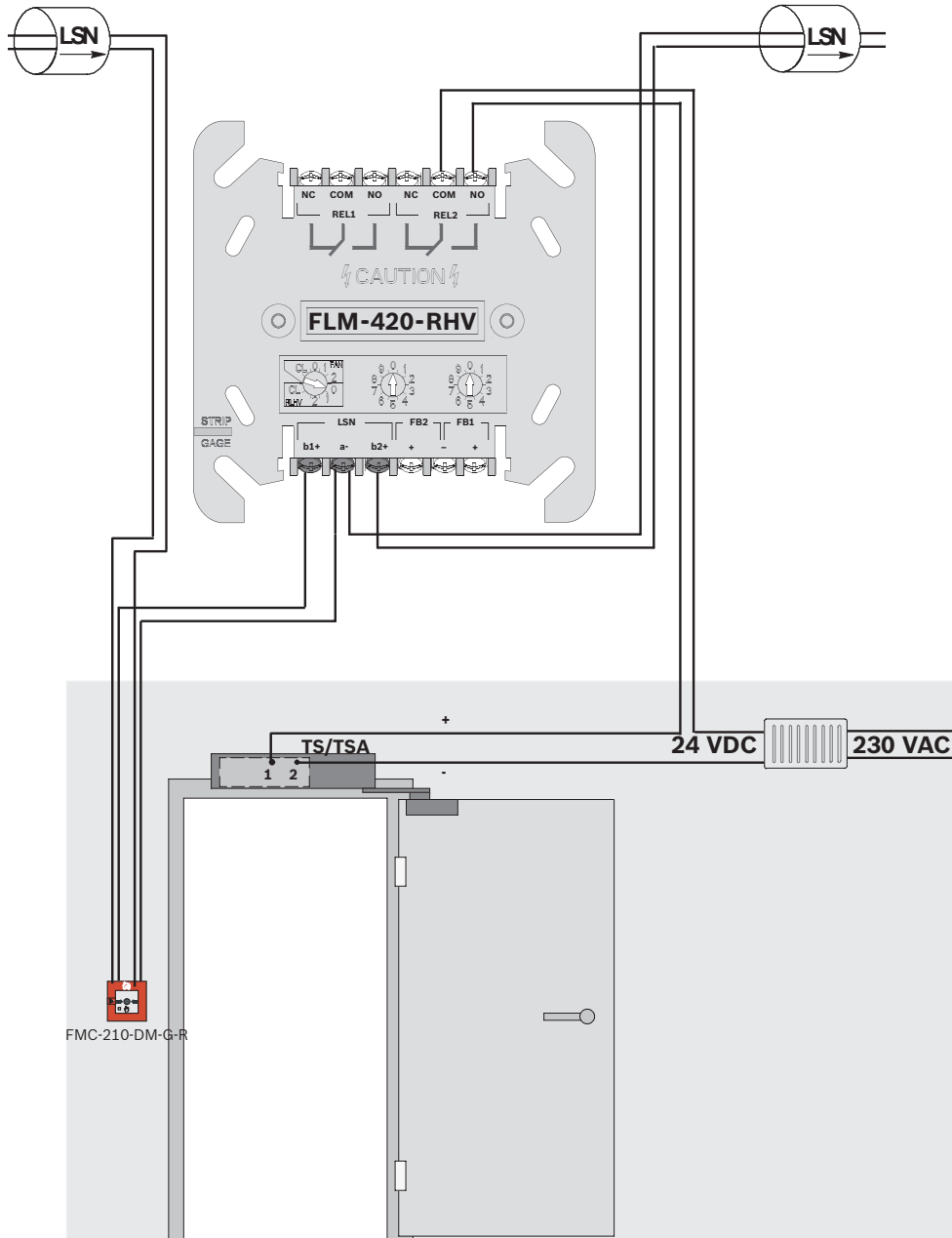



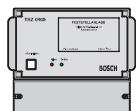

TSZ 0400

DIBT

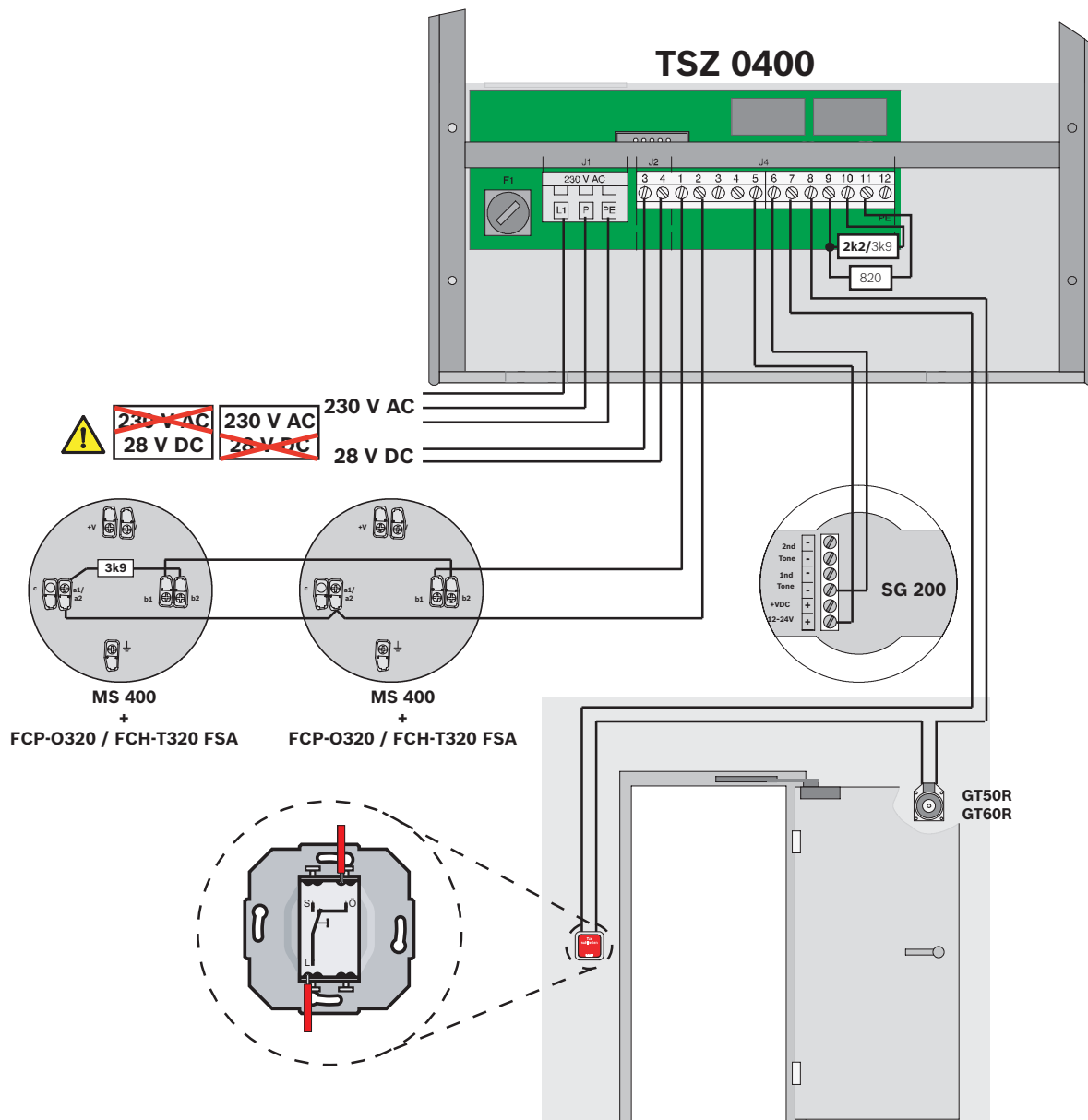

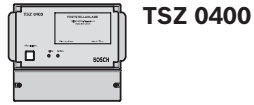

DIBT

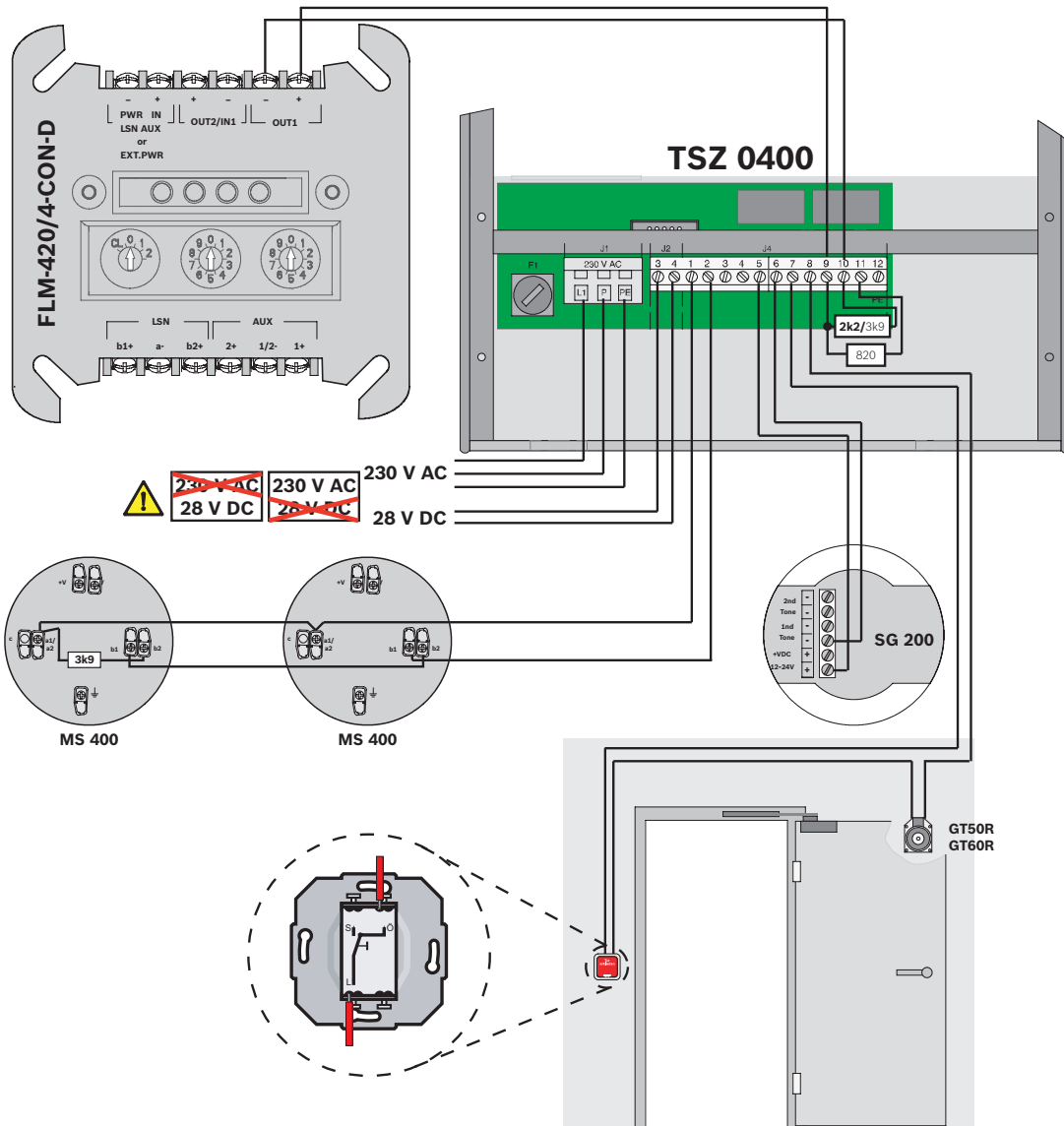

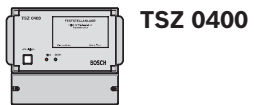

**DIBT**

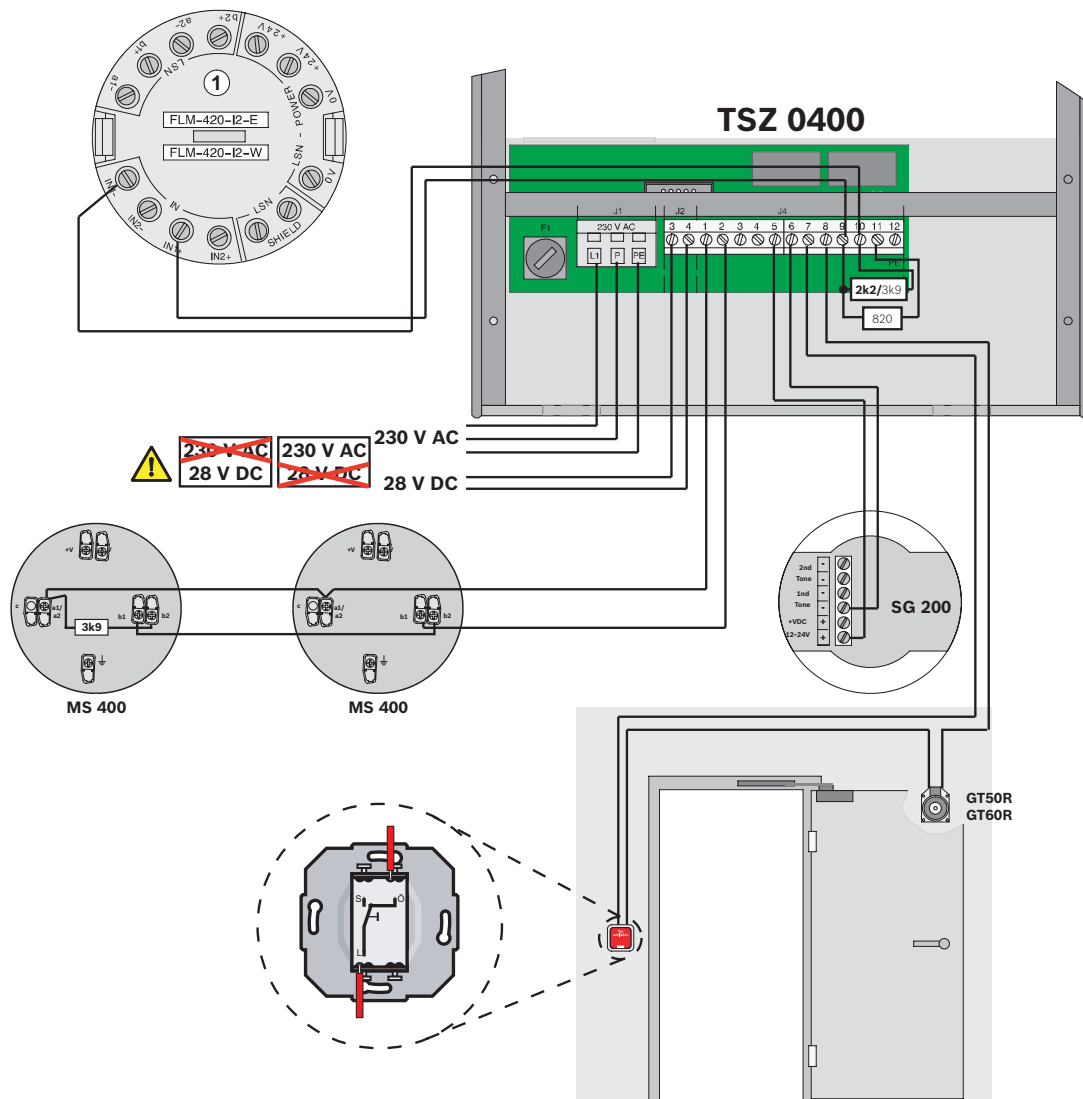

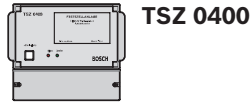
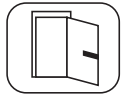

DIBT

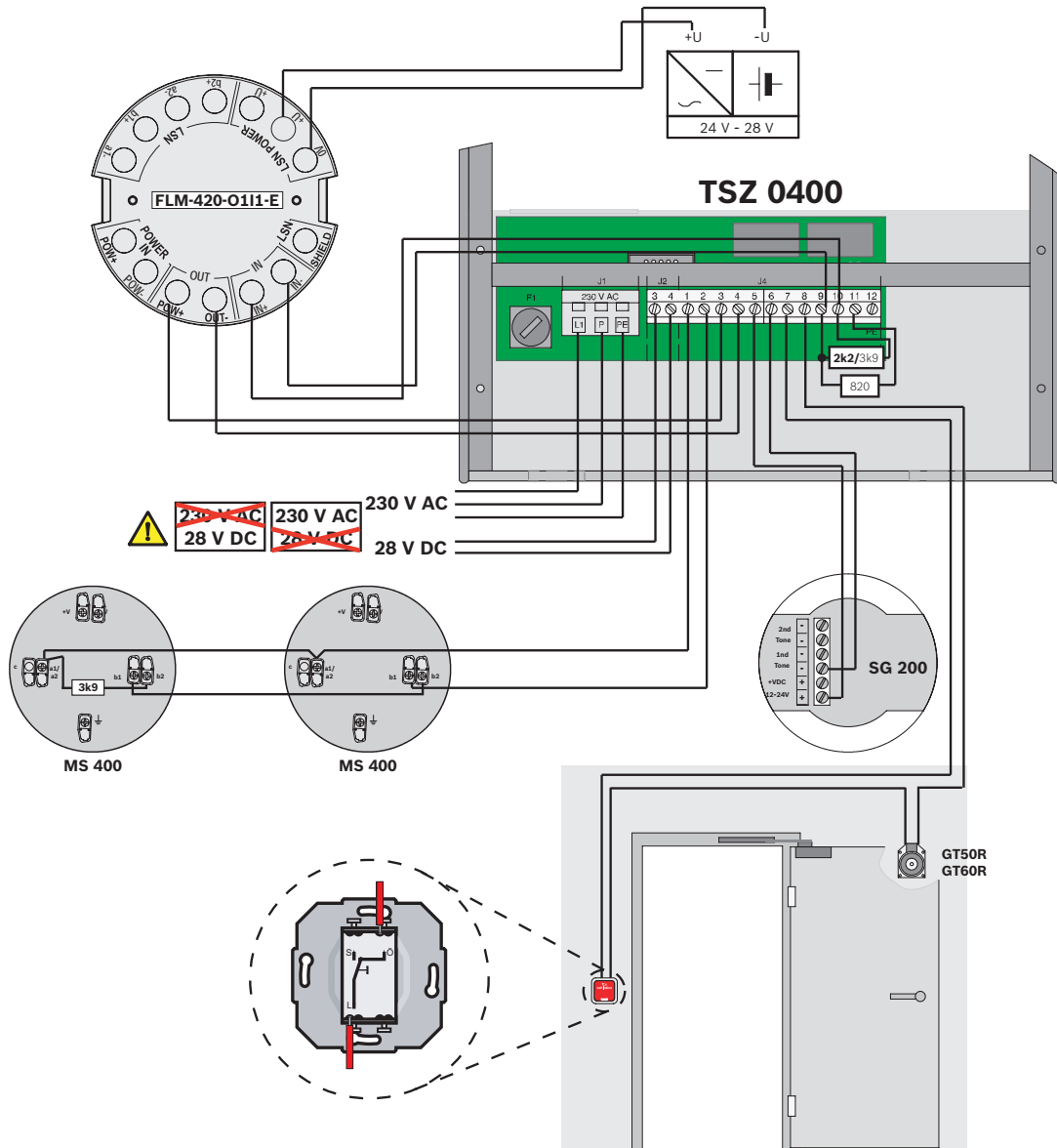

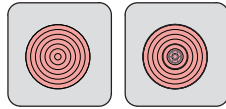

**FAA-420-RI-ROW**  
**FAA-420-RI-DIN**

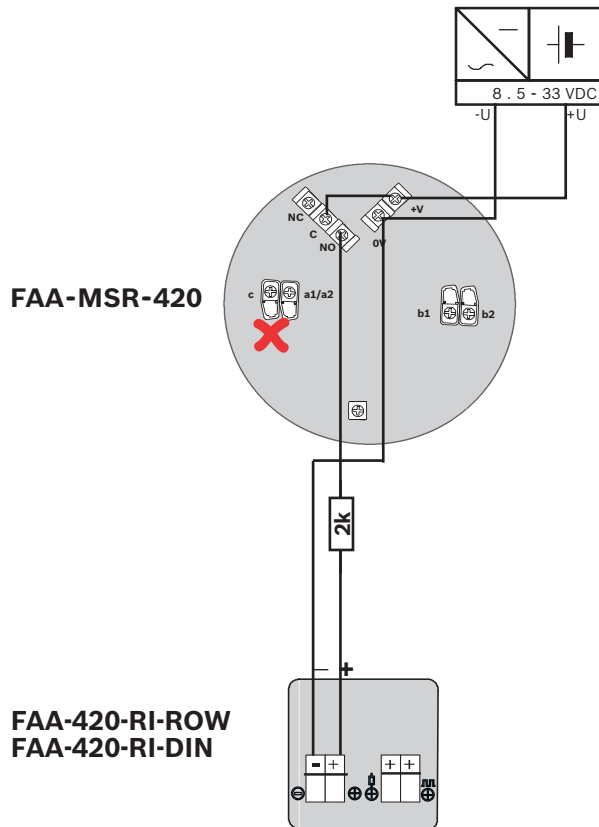
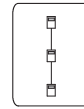

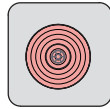

**FAA-420-RI-DIN**

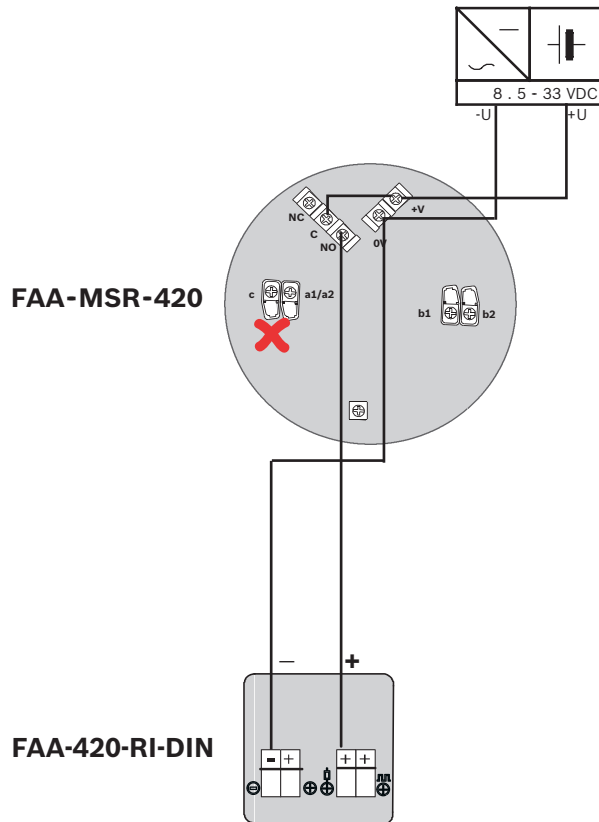
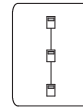





**FAA-420-RI-DIN**

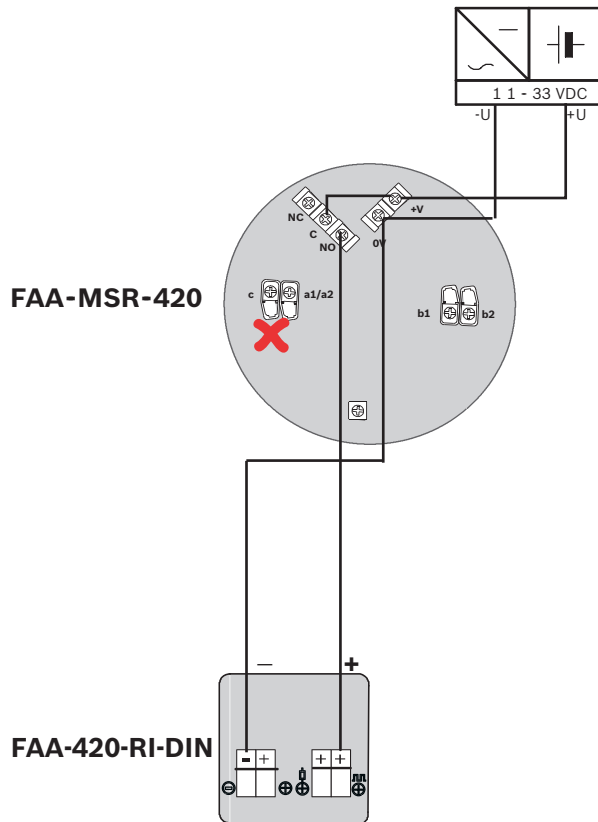
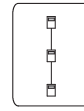

## 2.4

### Functional Modules



*BCM-000-B, Seite 43*

*CZM 0004 A, Seite 45*

*ENO 0000 A/B, Seite 61*

*LSN 0300 A, Seite 68*

*NZM 0002 A, Seite 106*

*RMH 0002 A, Seite 119*

*IOS 0020 A, Seite 120*

*FPE-5000-UGM, Seite 122*

2.4.1

BCM-000-B

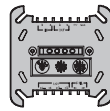
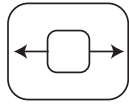

FLM-420-NAC-D

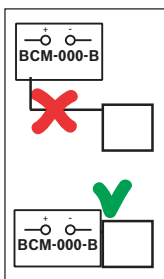
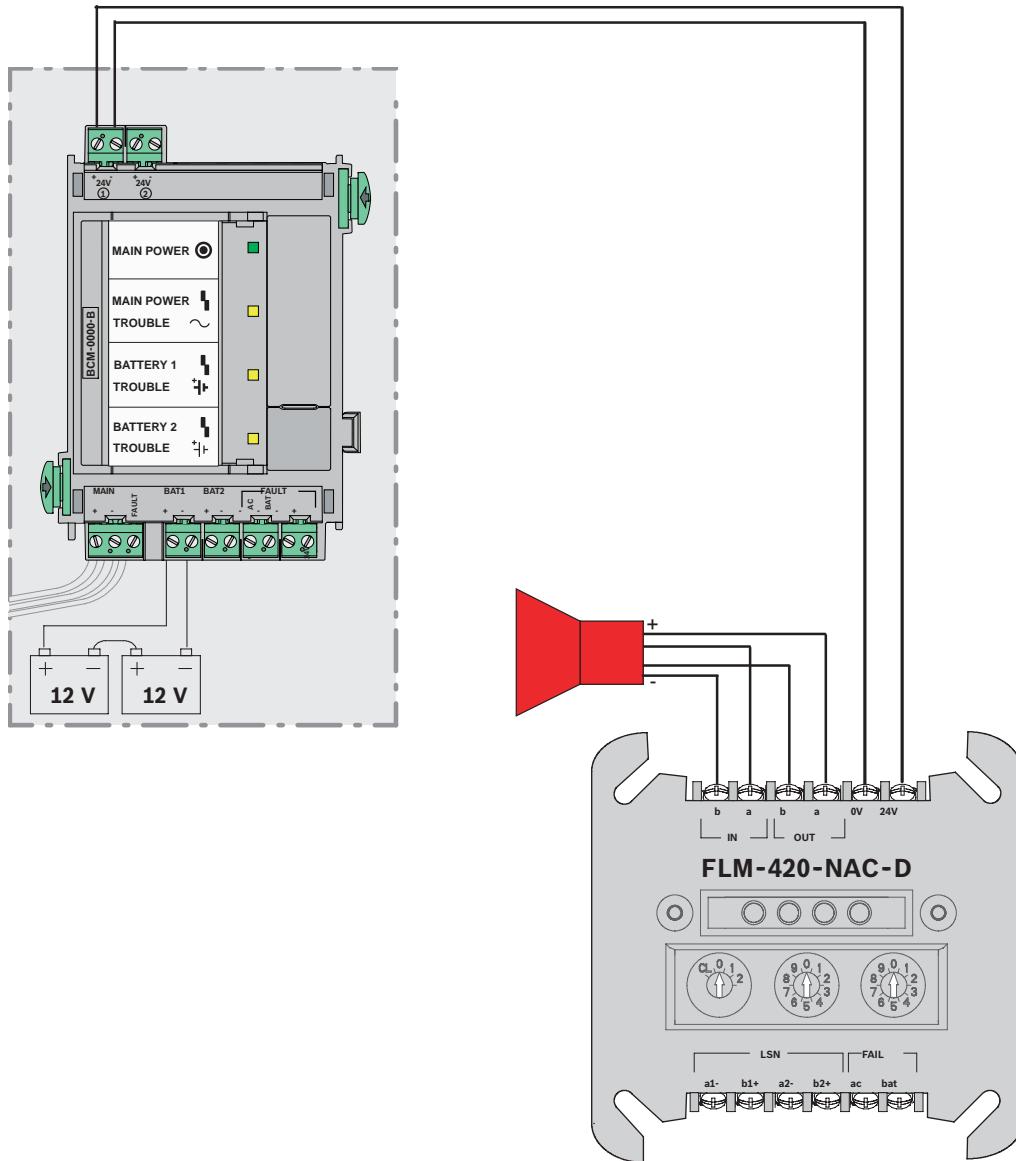
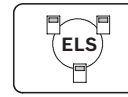

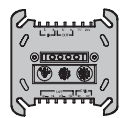
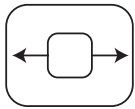

**FLM-420-NAC-D**

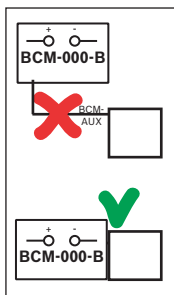
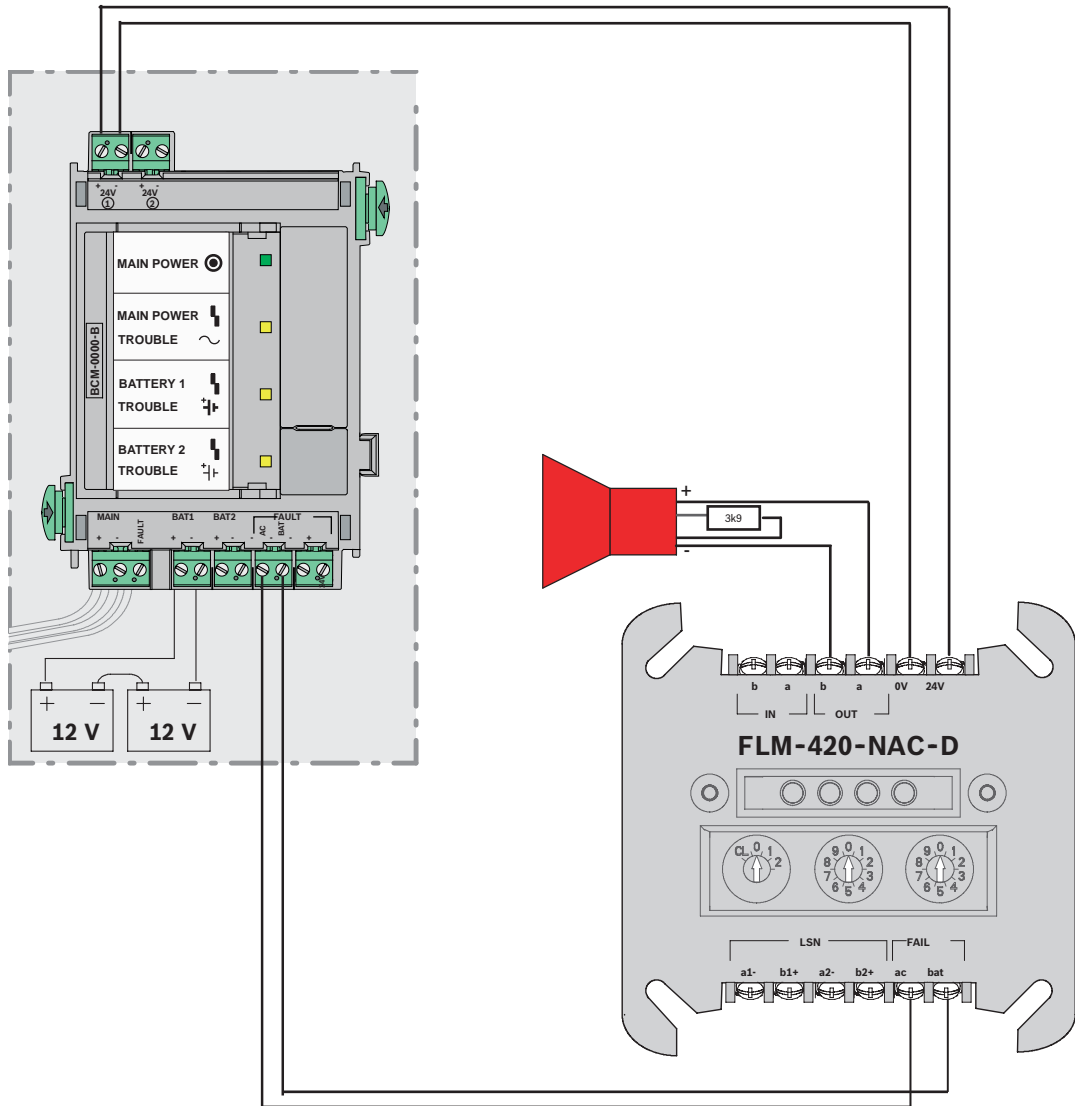
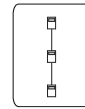

2.4.2

CZM 0004 A



**Firearay 50RV**  
**Firearay 100RV**

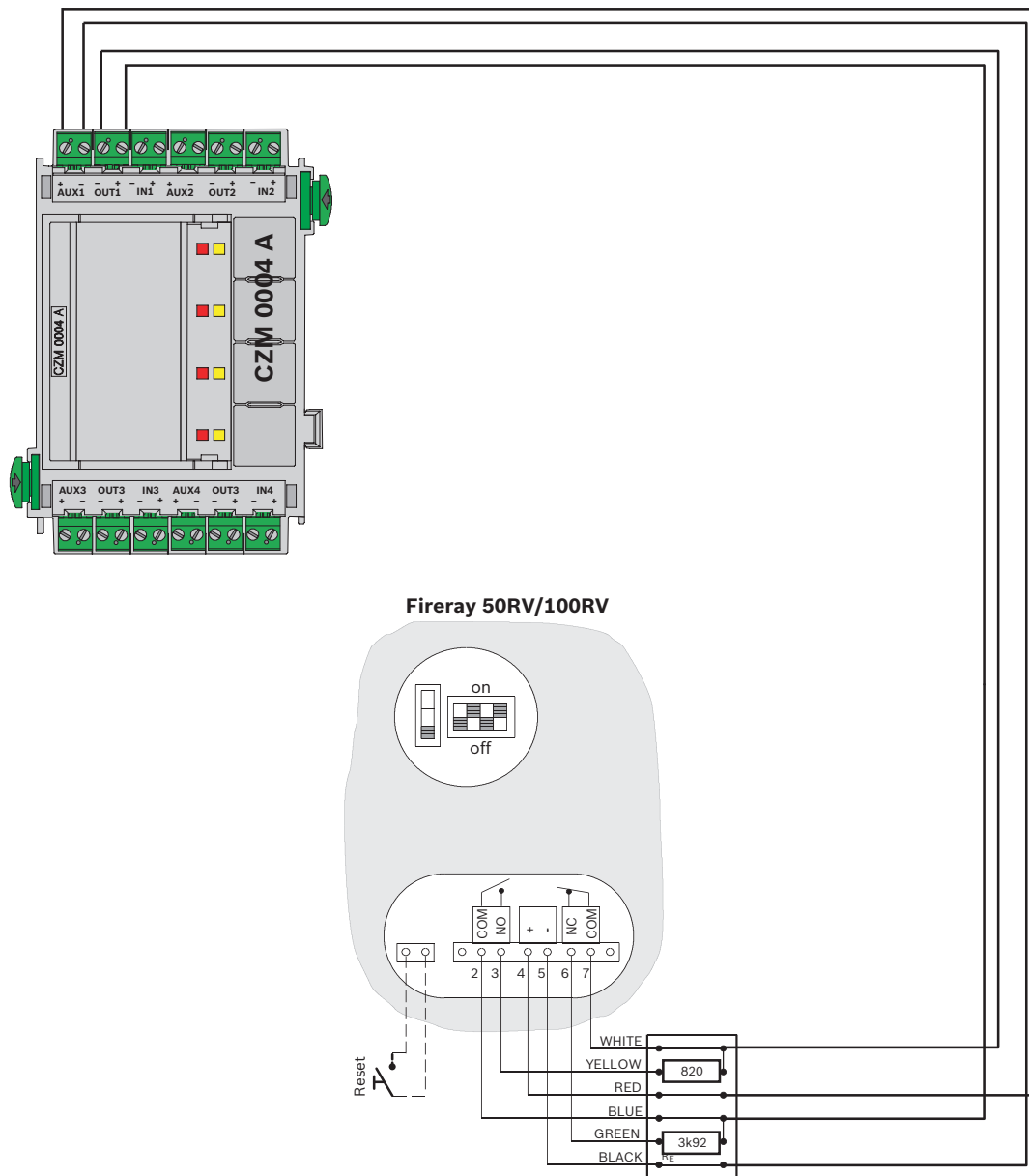



**FIRERAY3000**

1 x



BCM-0000-B  
LSN 0300 A  
LSN 1500 A

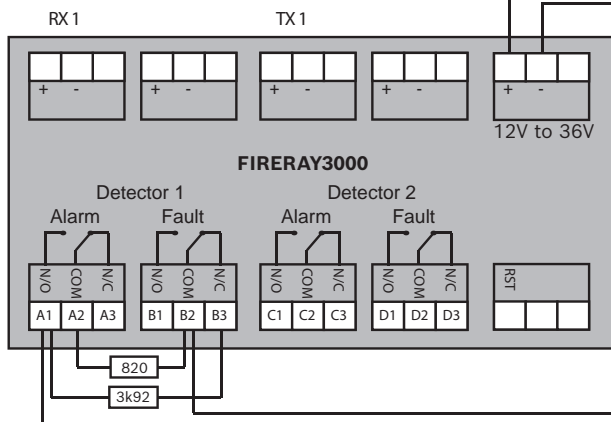
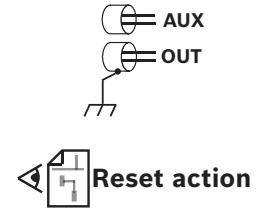
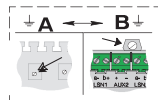
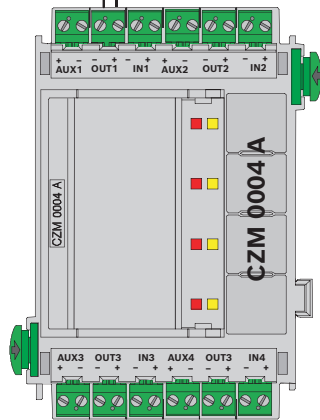



**FIRERAY3000**  
2 x  **OUT1**



BCM-000-B  
LSN 0300 A  
LSN 1500 A

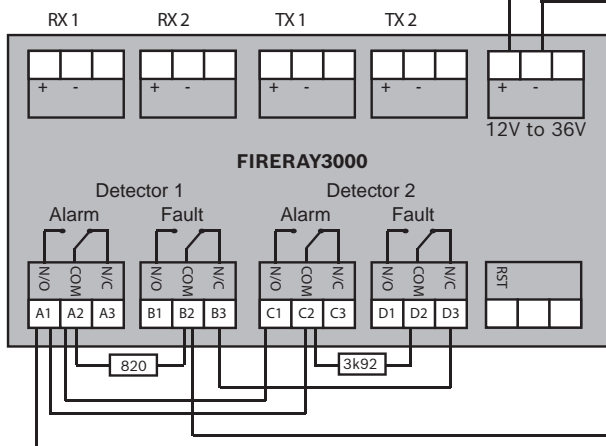
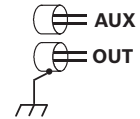
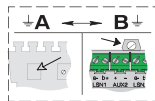
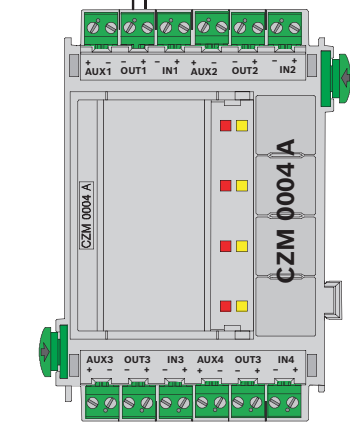



**FIRERAY3000**  
2 x **OUT1+2**



BCM-0000-B  
LSN 0300 A  
LSN 1500 A

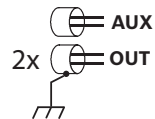
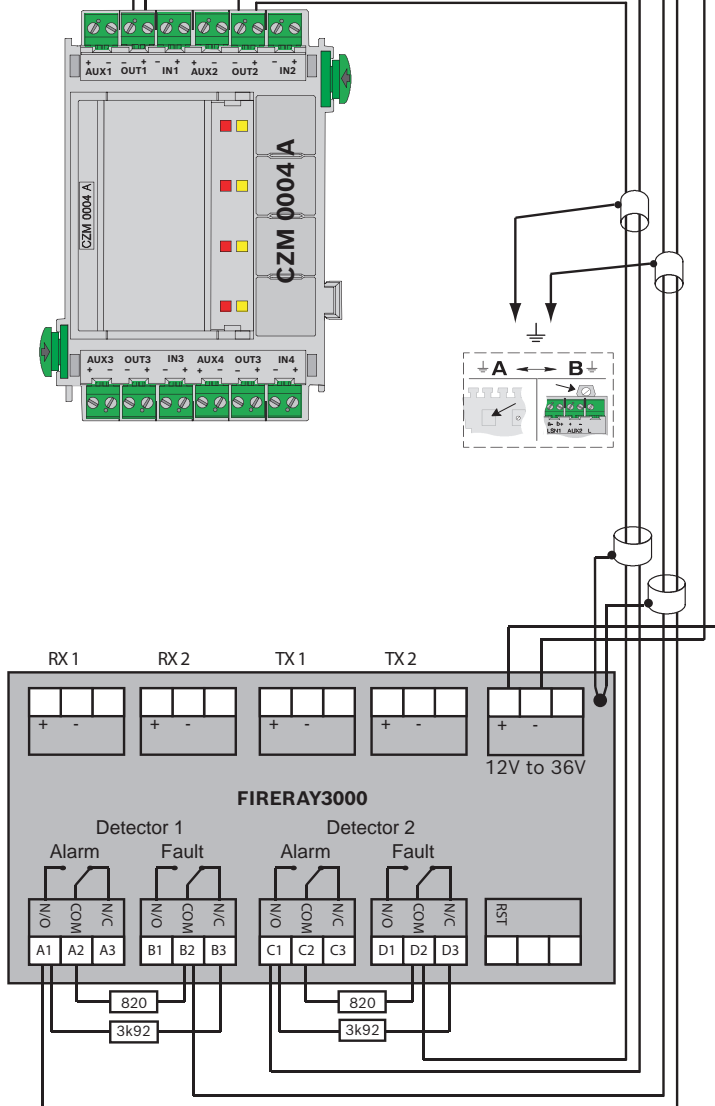

**Reset action**





**FIRERAY5000**

1 x



BCM-0000-B  
LSN 0300 A  
LSN 1500 A

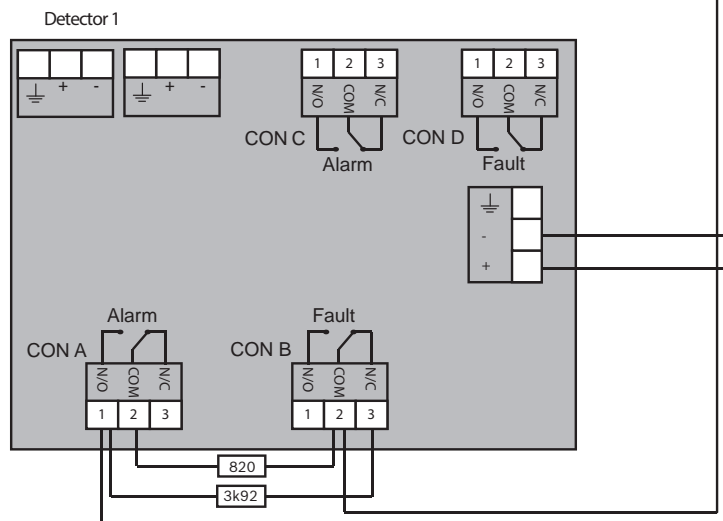
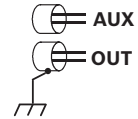
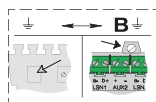
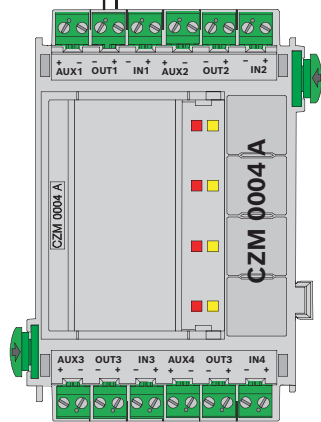



**FIRERAY5000**

**2 x OUT1**

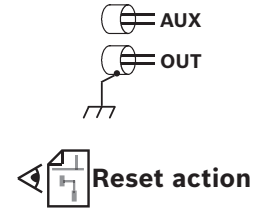
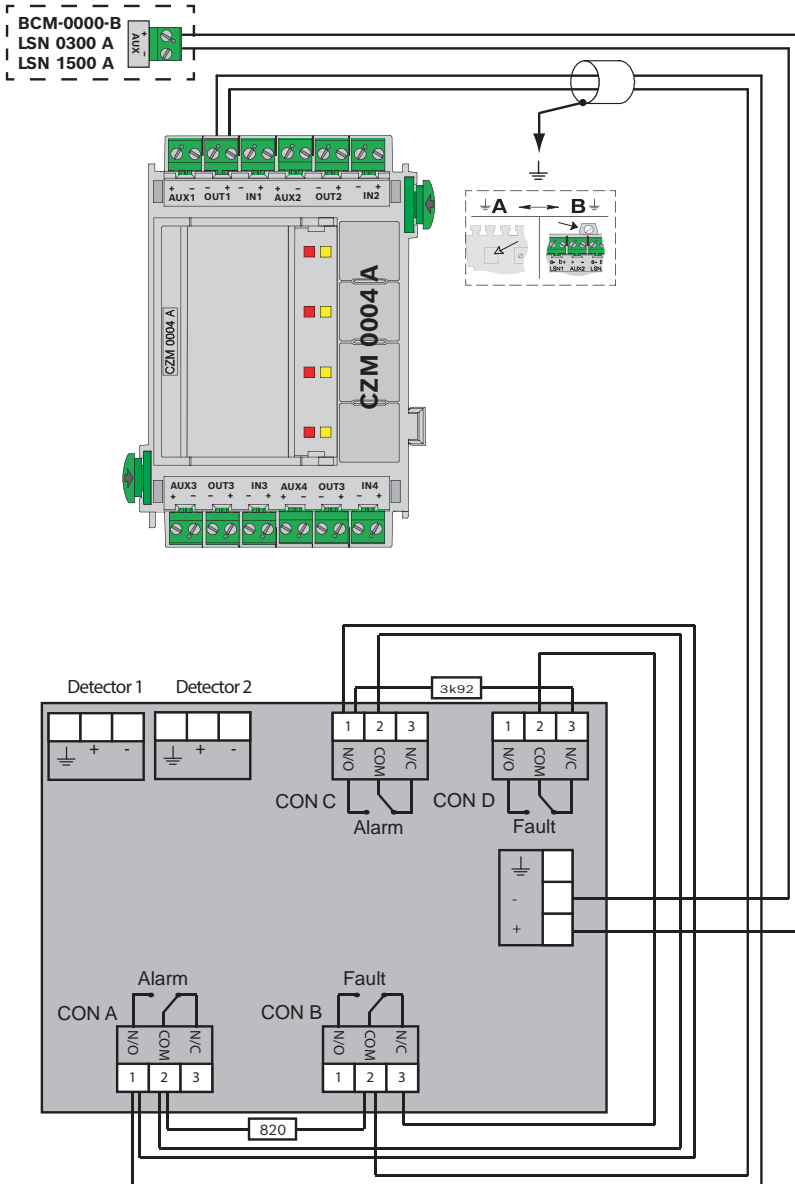

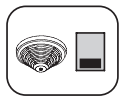

**FIRERAY5000**  
2 x  **OUT1**

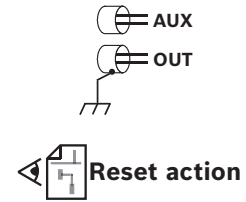
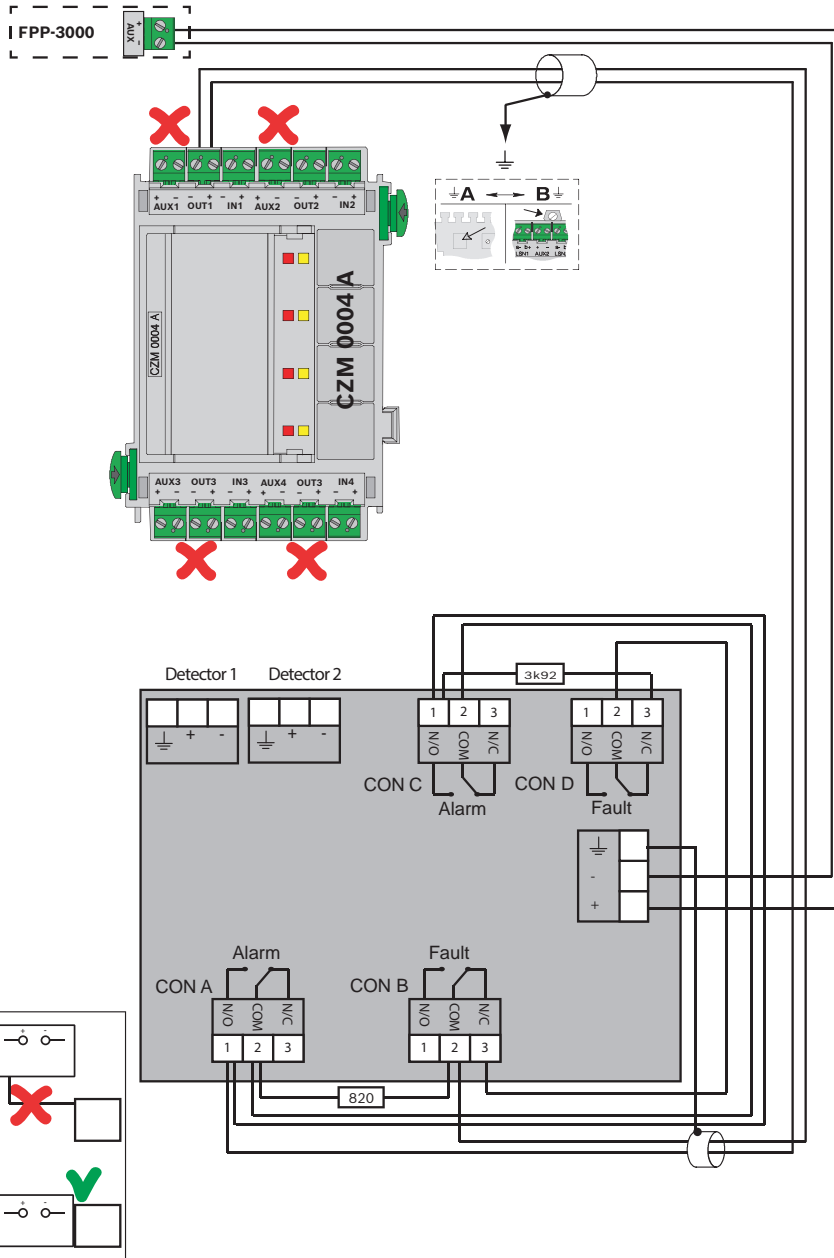

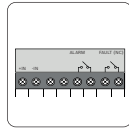

**016519, 016589  
IR3 Flame Detector**

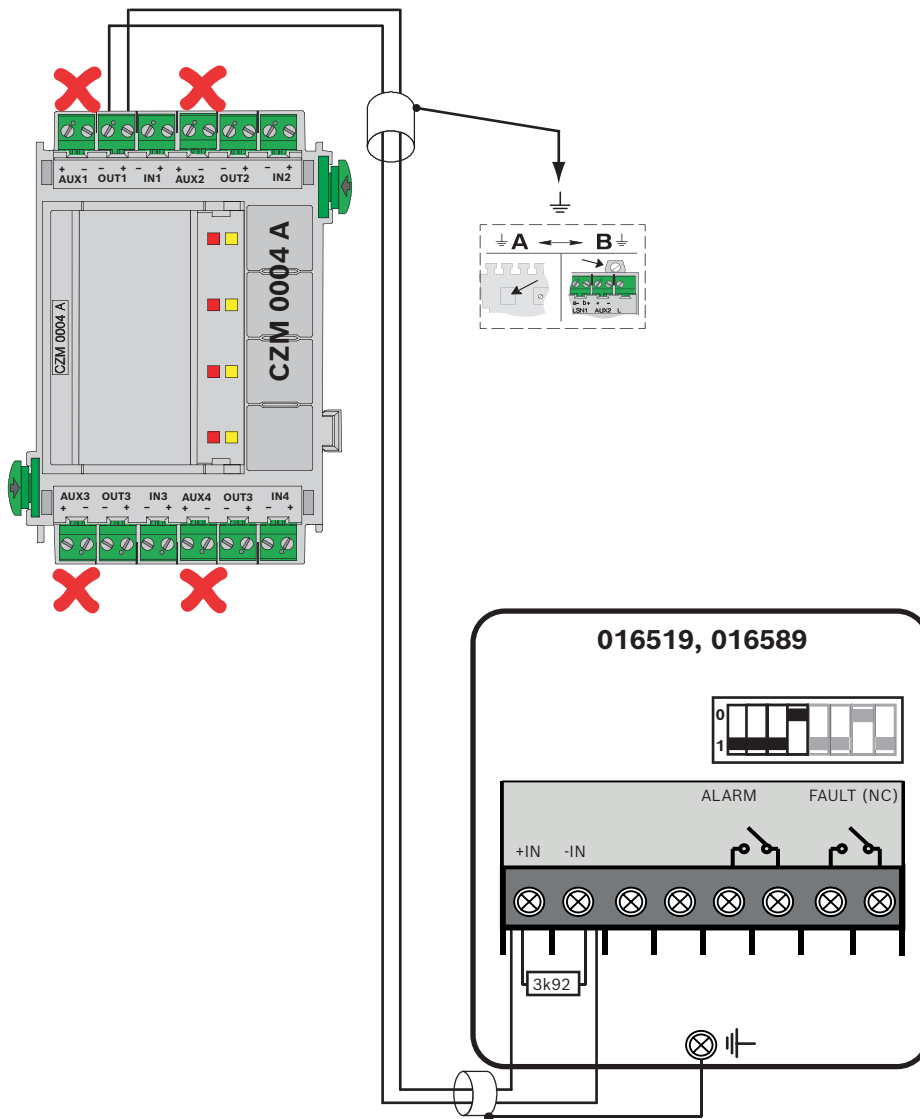
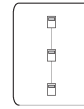

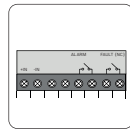

**016519, 016589  
IR3 Flame Detector**

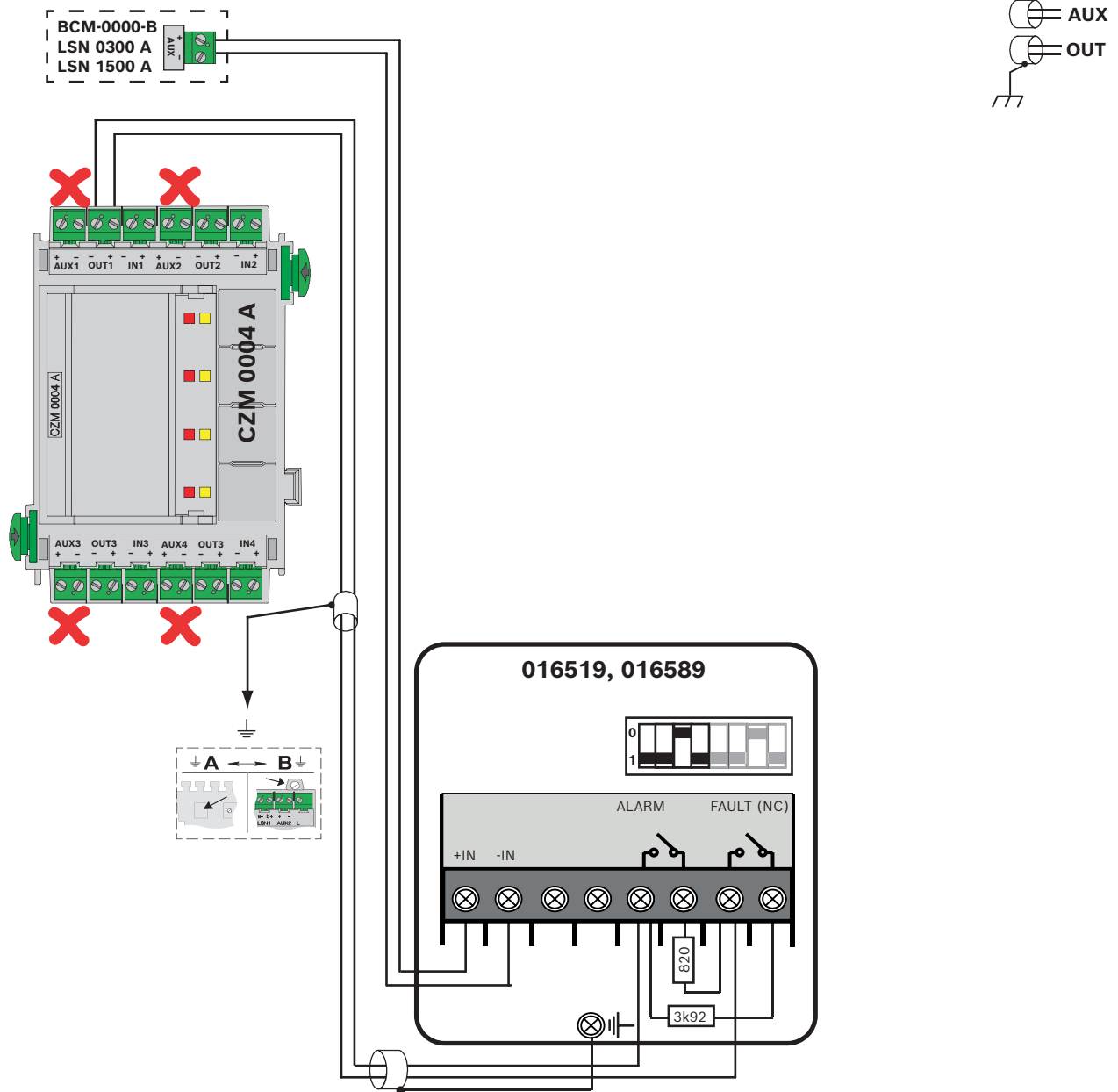
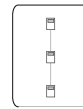

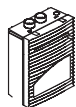

FCS-320-TM Series

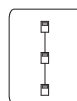

BCM-0000-B  
LSN 0300 A  
LSN 1500 A

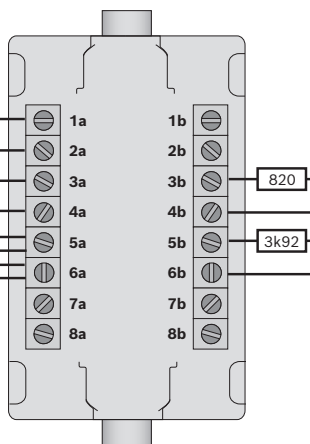
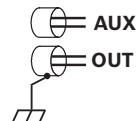
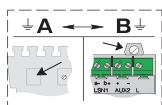
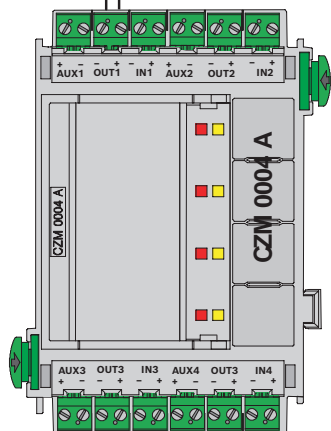

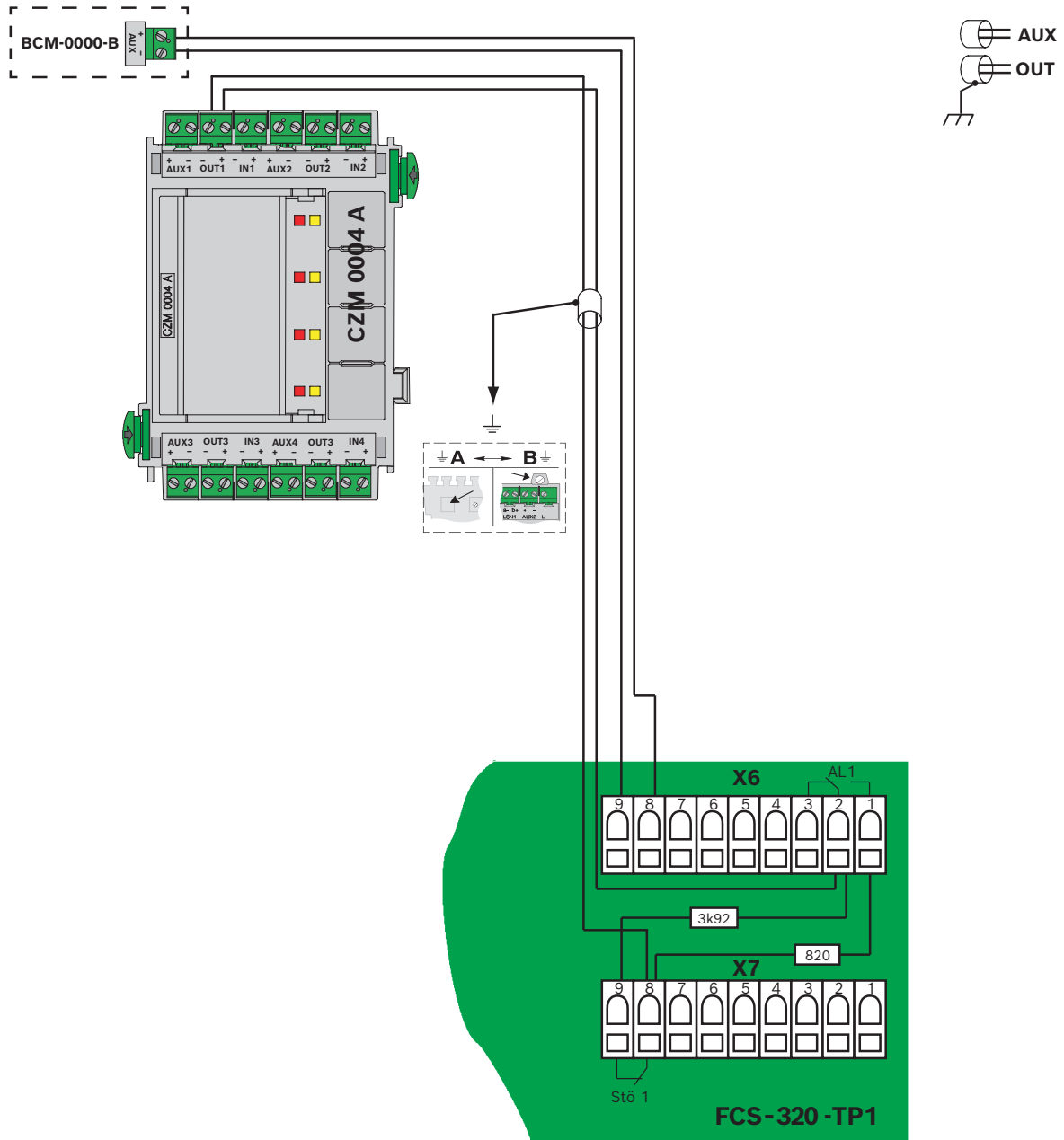
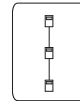
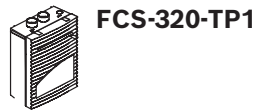

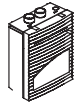

FCS-320-TP2

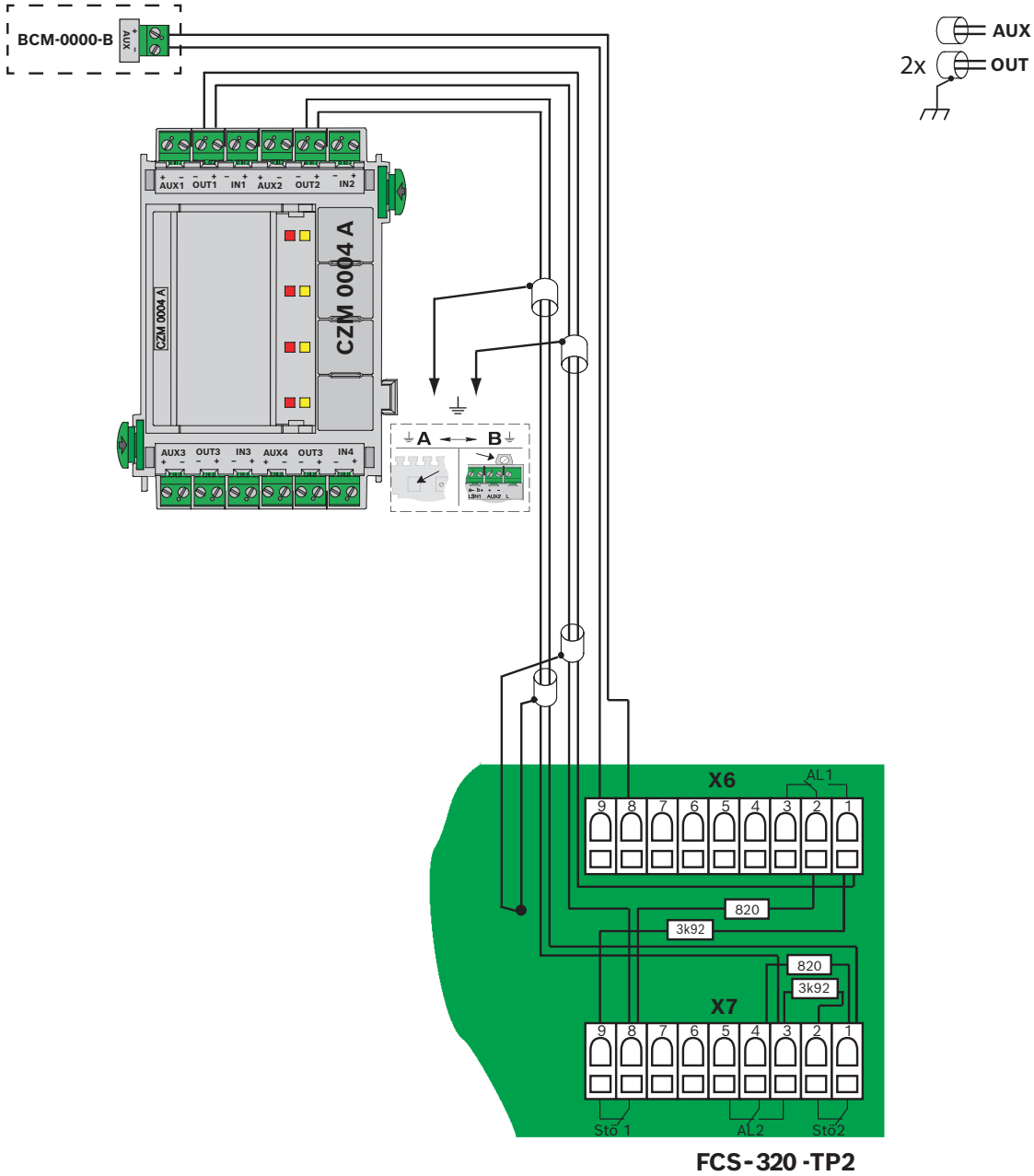

FCS-320-TP2





FCS-LWM-1

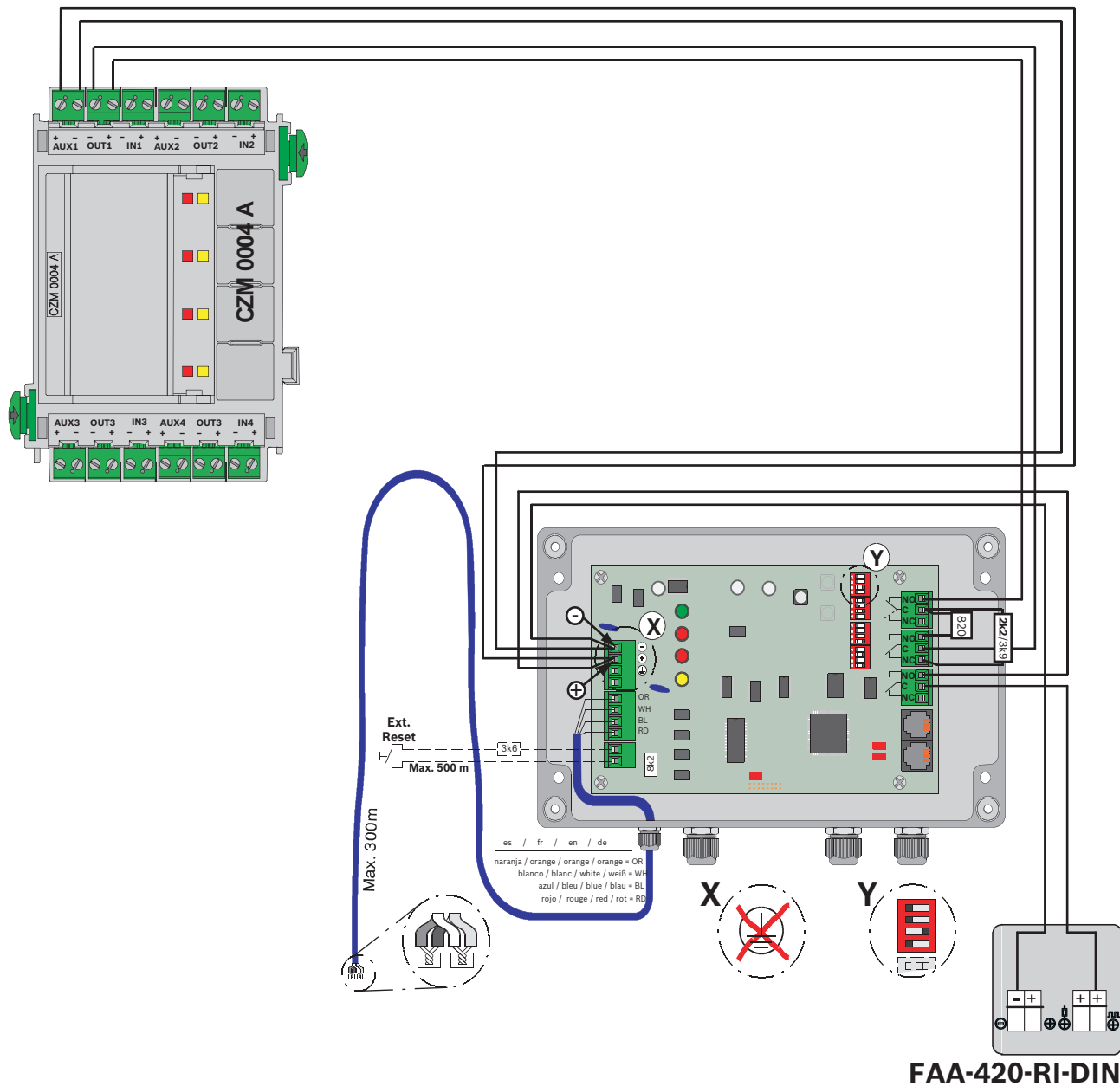



FCA-500-EU  
 FCP-O 500  
 FCP-O 500-P  
 FCP-OC 500  
 FCP-OC 500-P

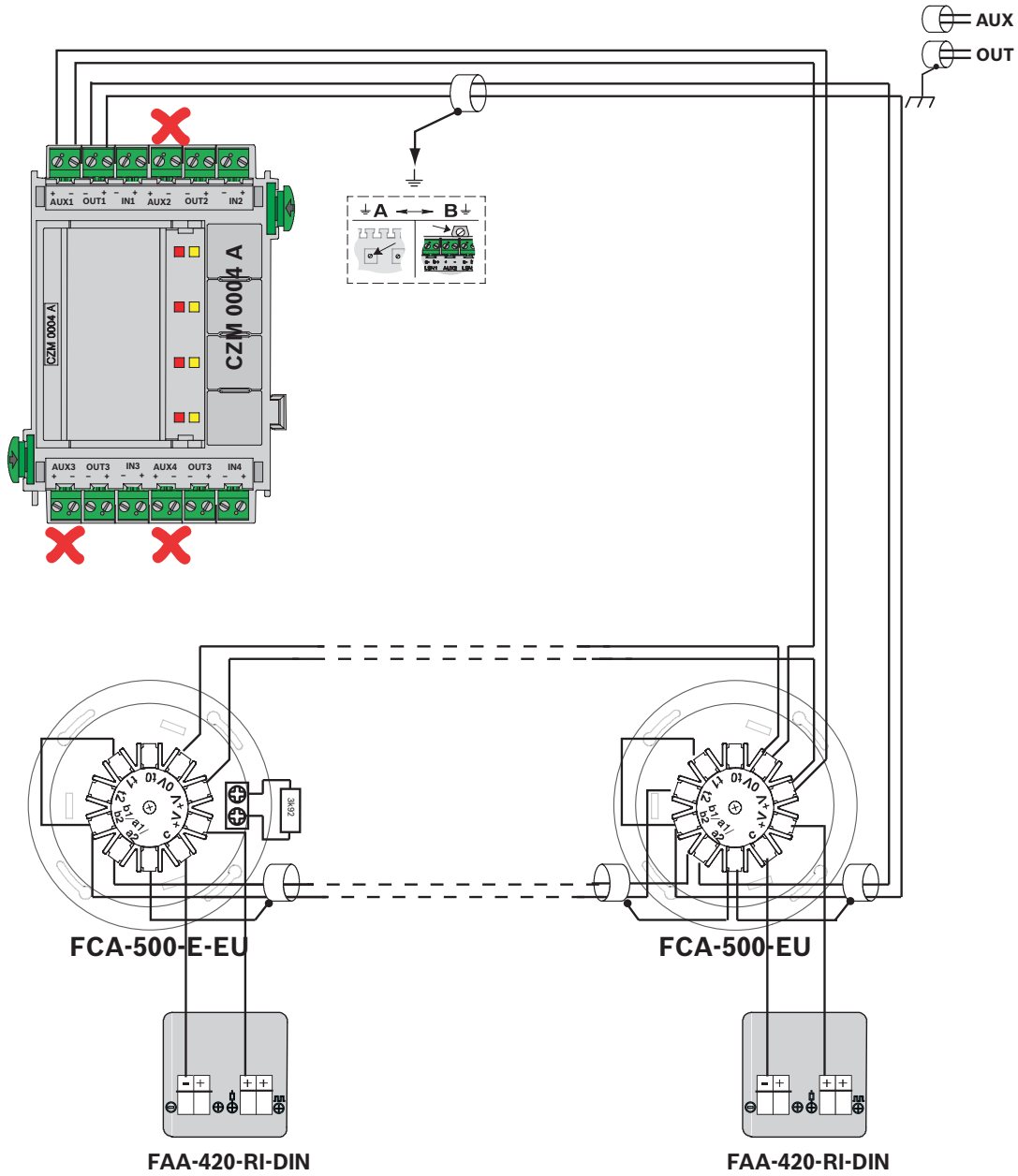

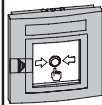
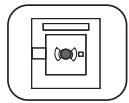

**FMC-120-DKM-G-R**  
**FMC-120-DKM-H-R**  
**FMC-120-DKM-G-B**  
**FMC-120-DKM-H-B**  
**FMC-120-DKM-G-Y**

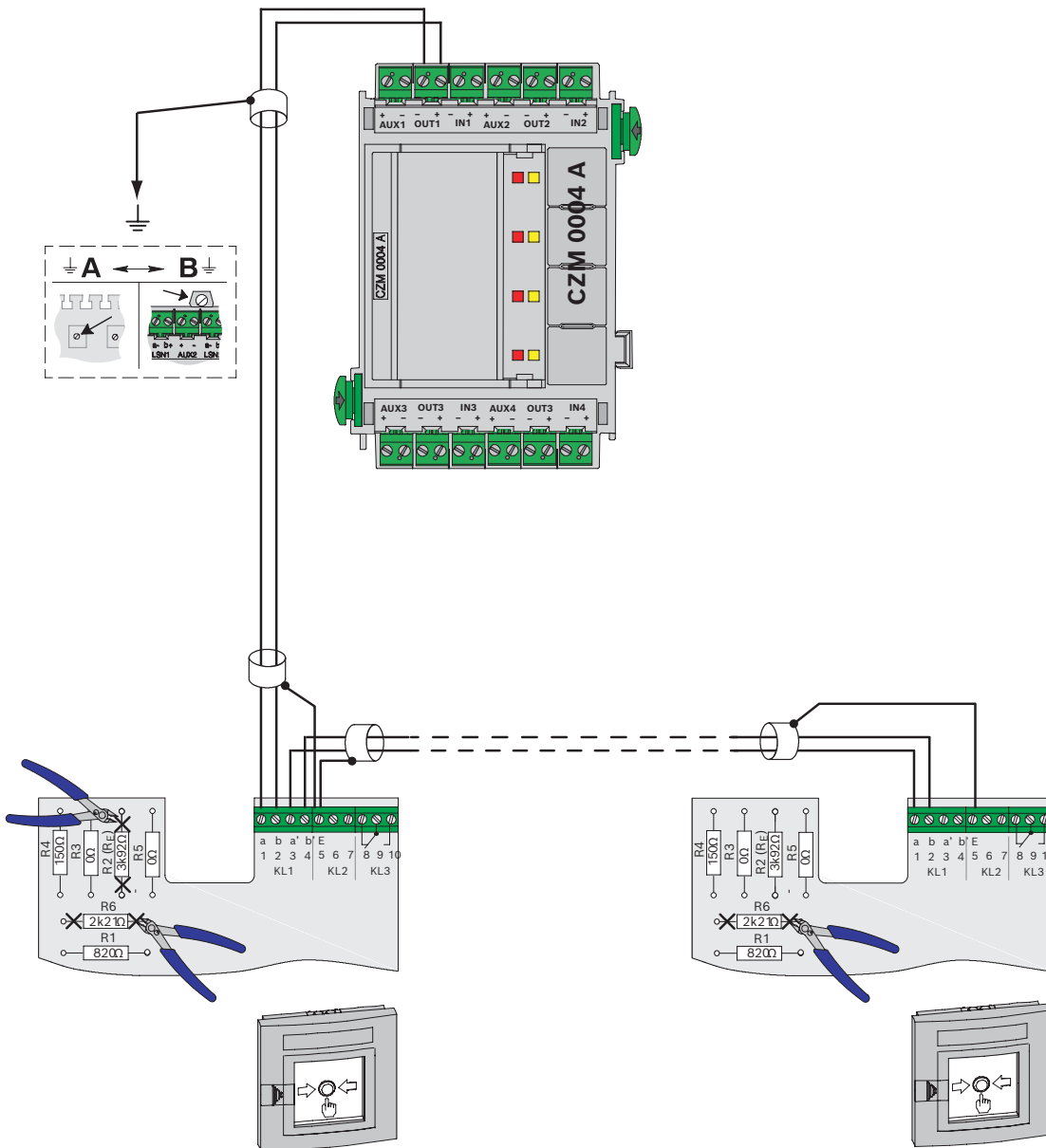
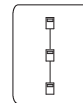

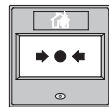
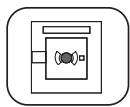

**FMC-300RW-GSGBU**  
**FMC-300RW-GSRBU**  
**FMC-300RW-GSGRD**  
**FMC-300RW-GSRRD**  
**FMC-300RW-GSGYE**  
**FMC-300RW-GSRYE**

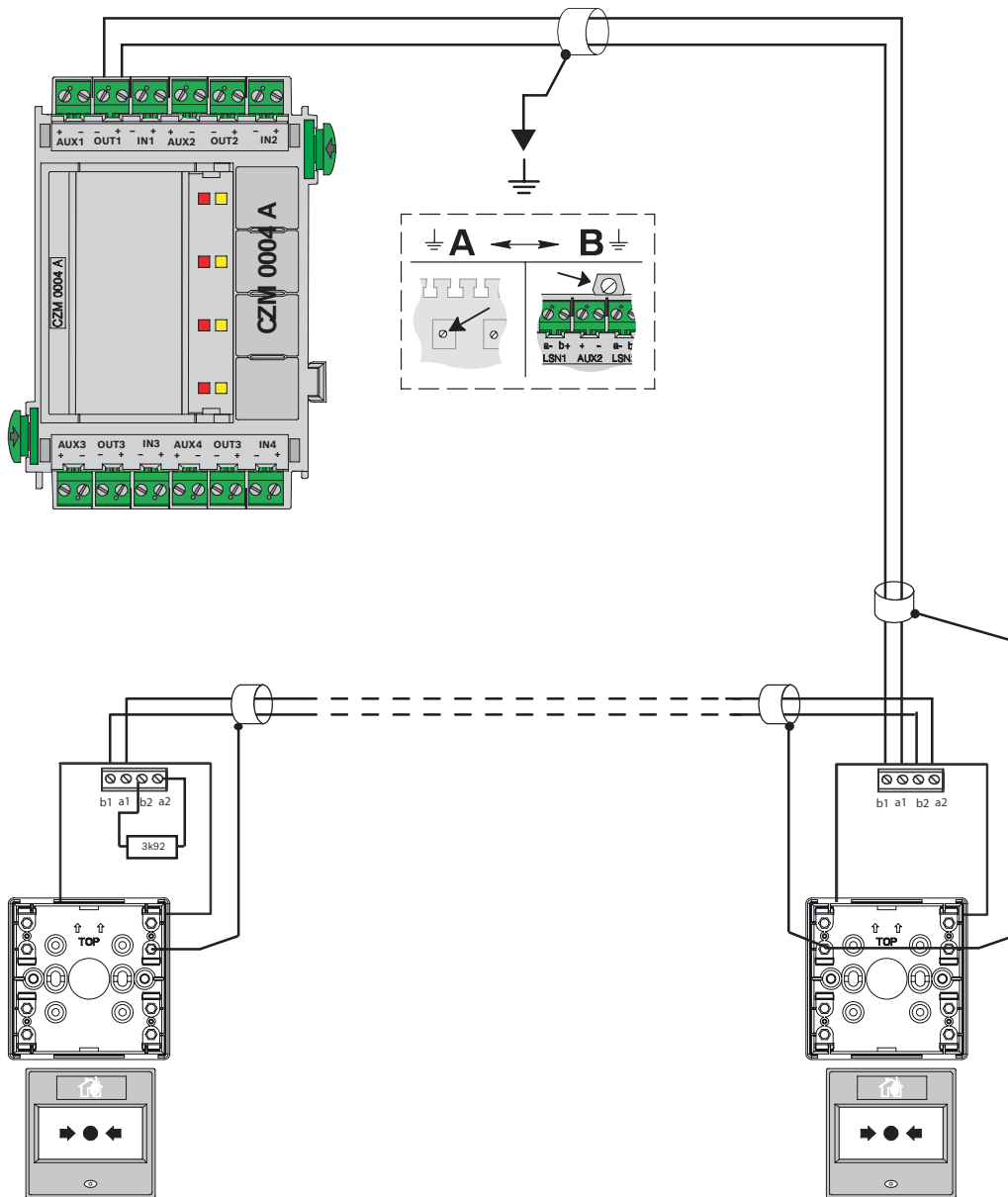
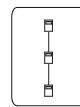

### 2.4.3 ENO 0000 A/B



AT5000 IP/GPRS

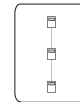

EN 54-2

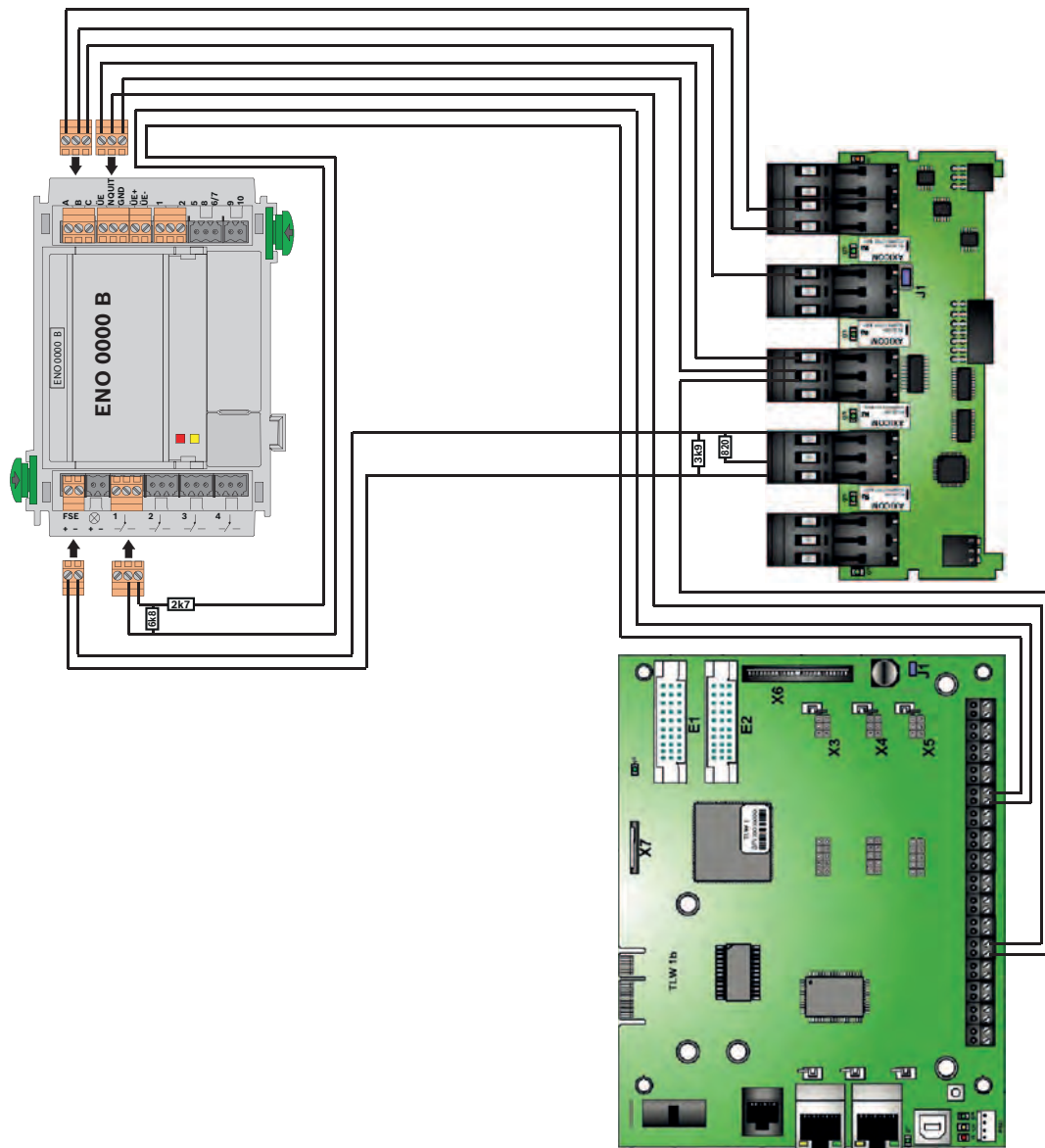

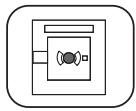

MDL-F

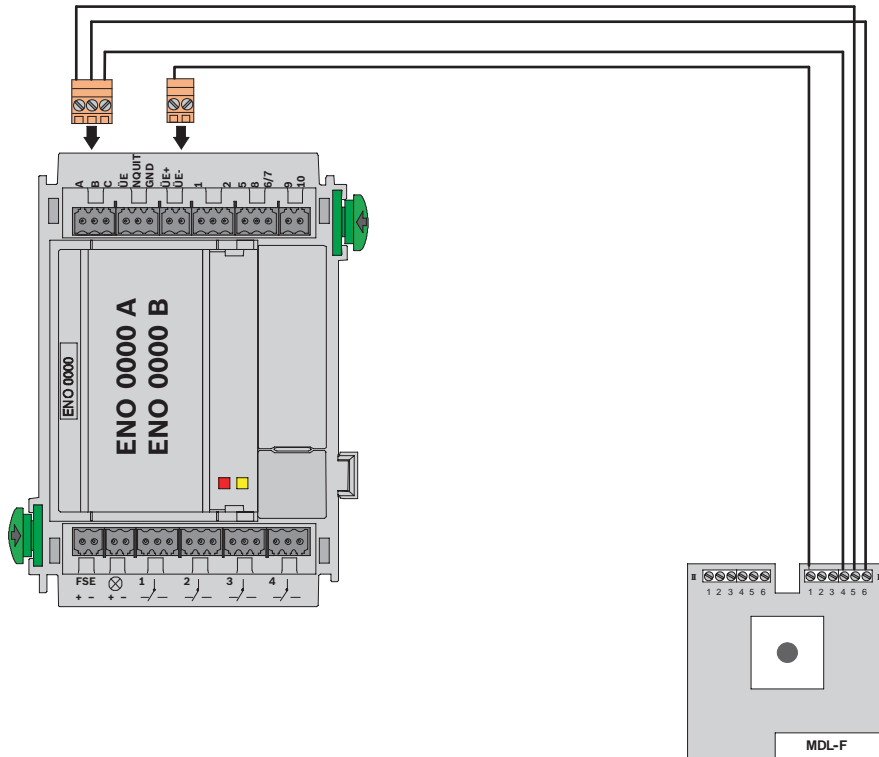

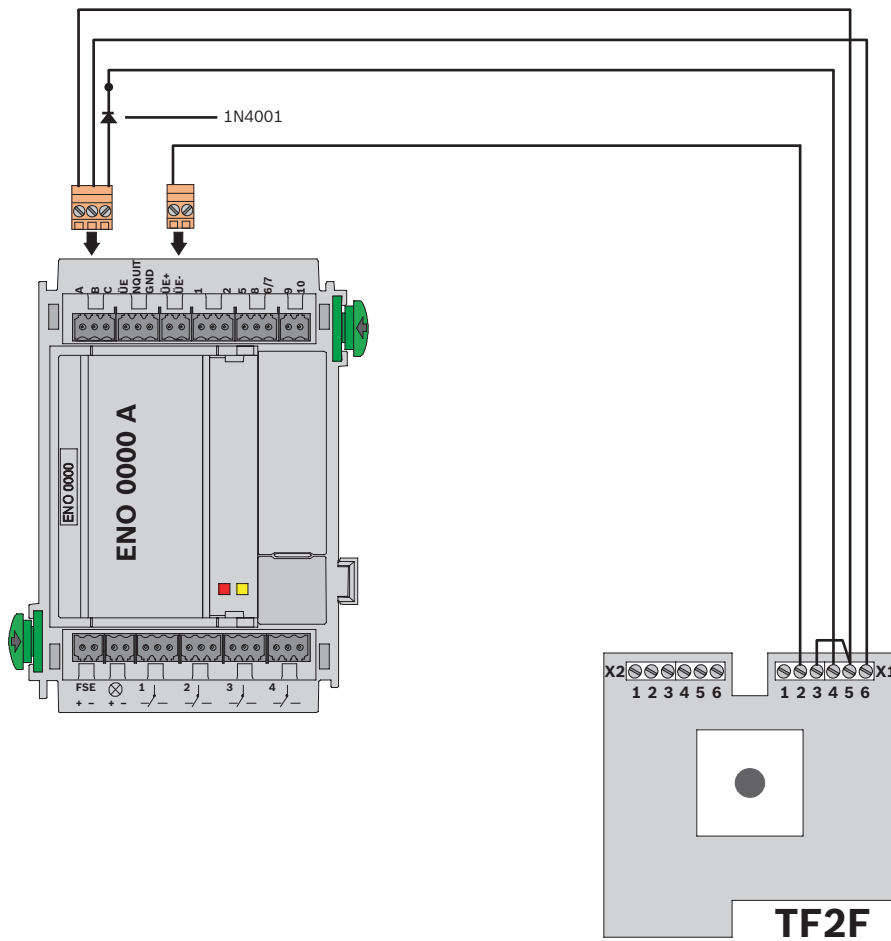
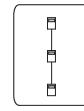
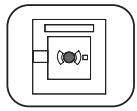

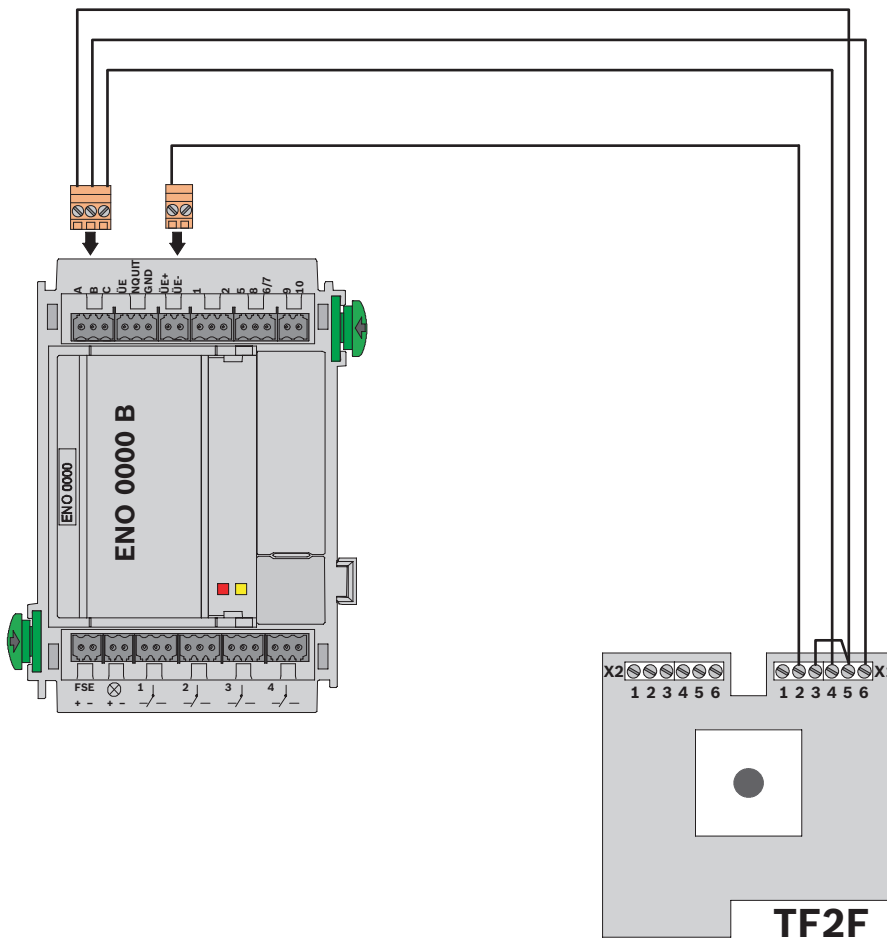
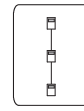
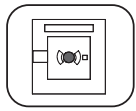



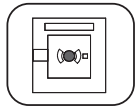

UE-F-D/T

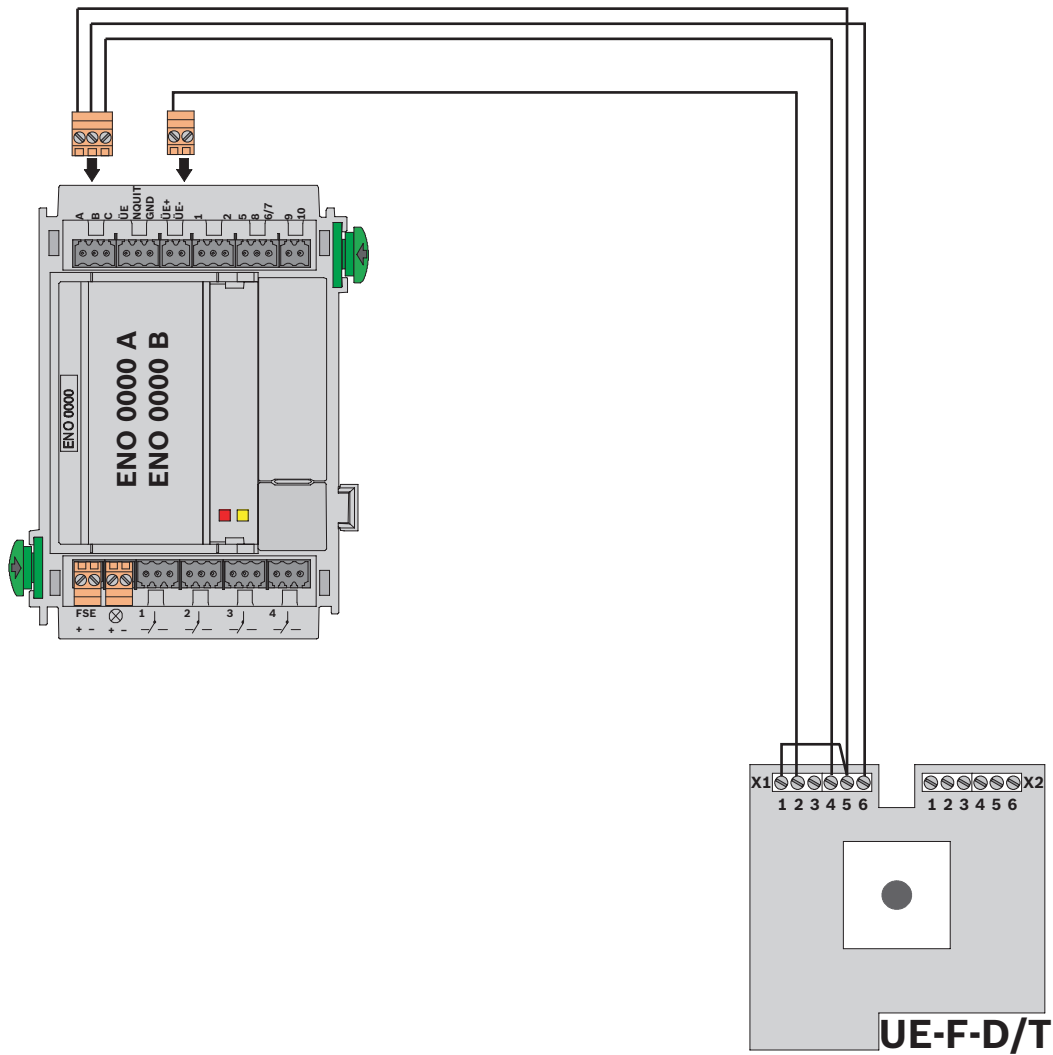

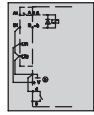

**GÜ 101-B**

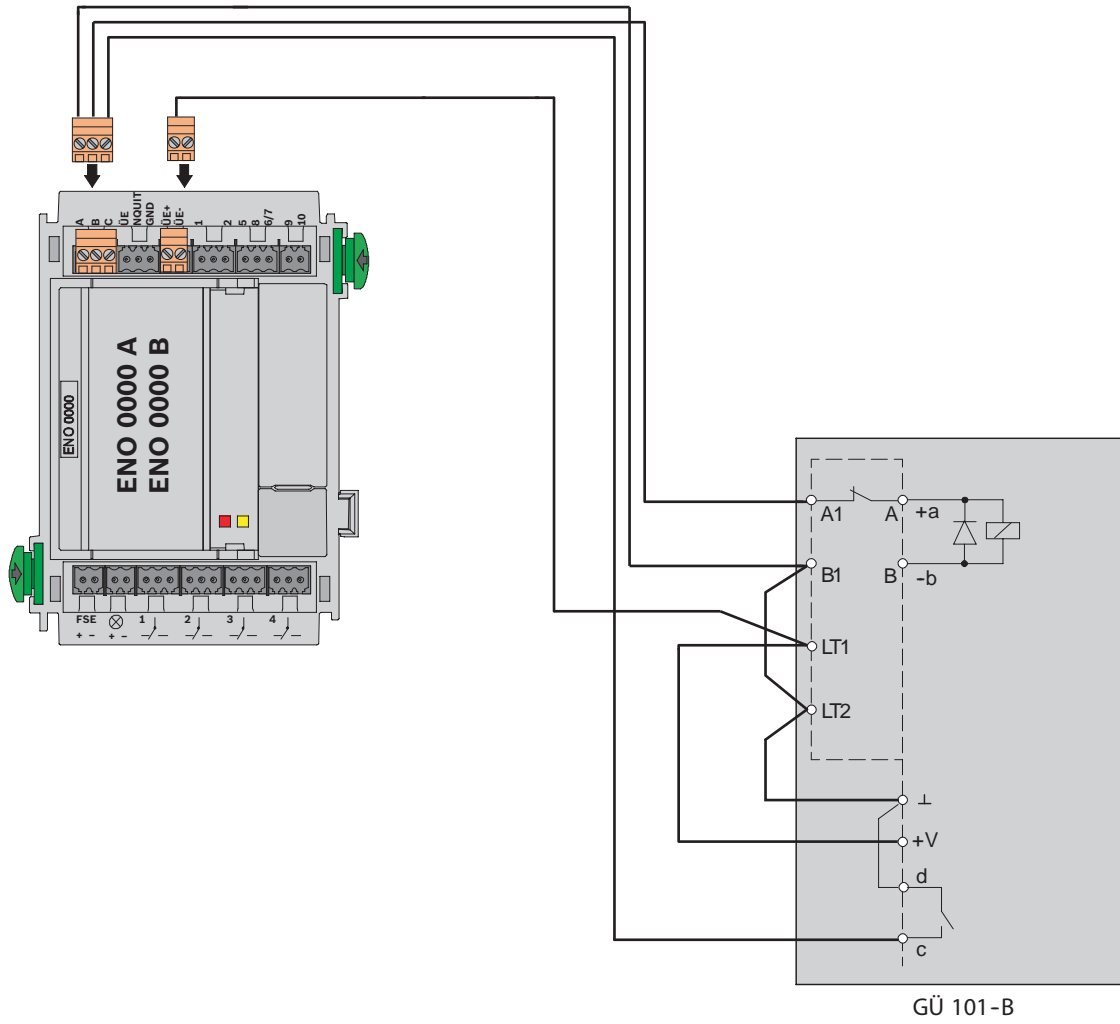
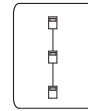

GÜ 101-B

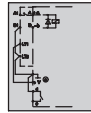

**GÜ 101-B**

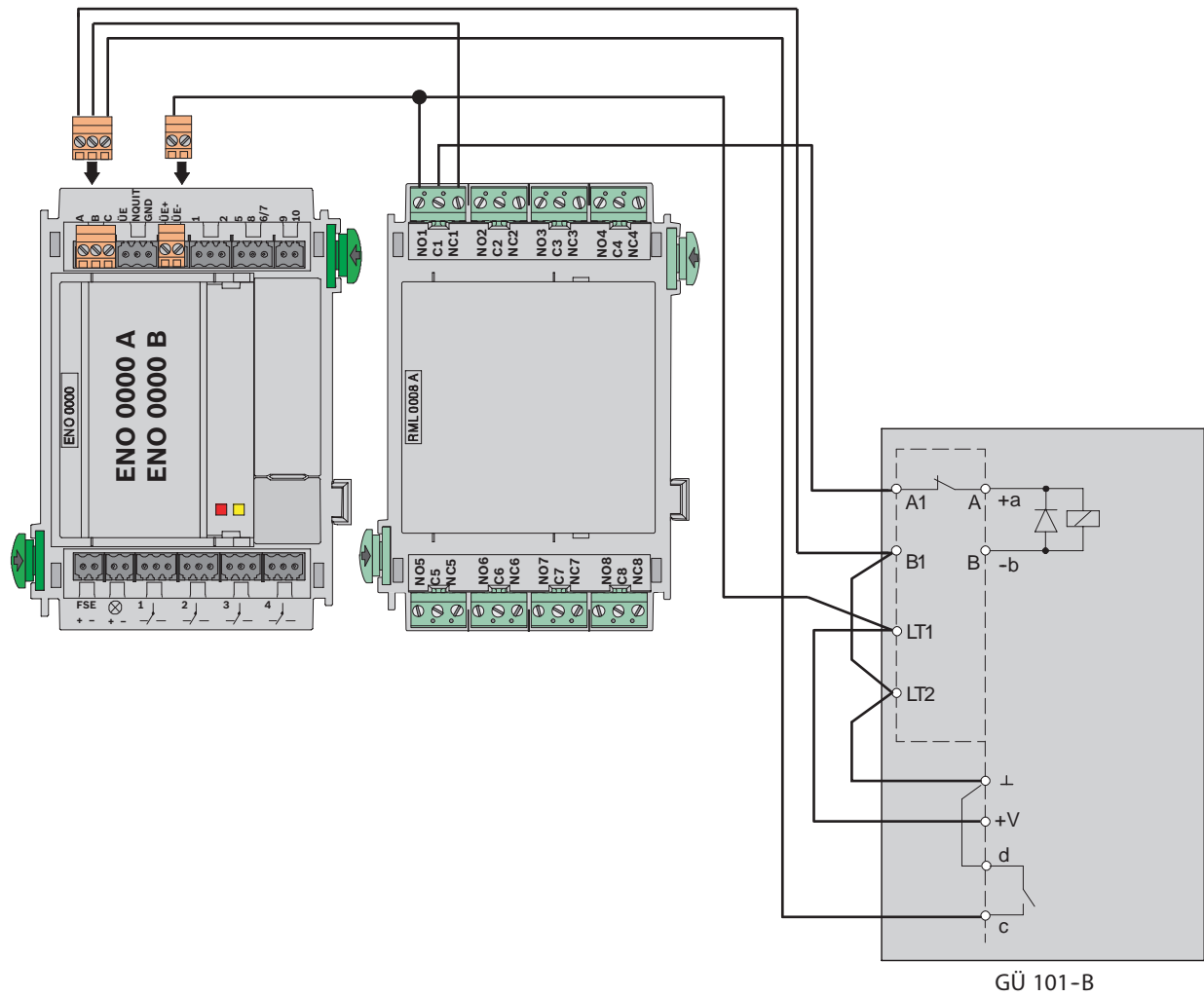
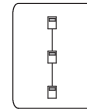

2.4.4

LSN 0300 A

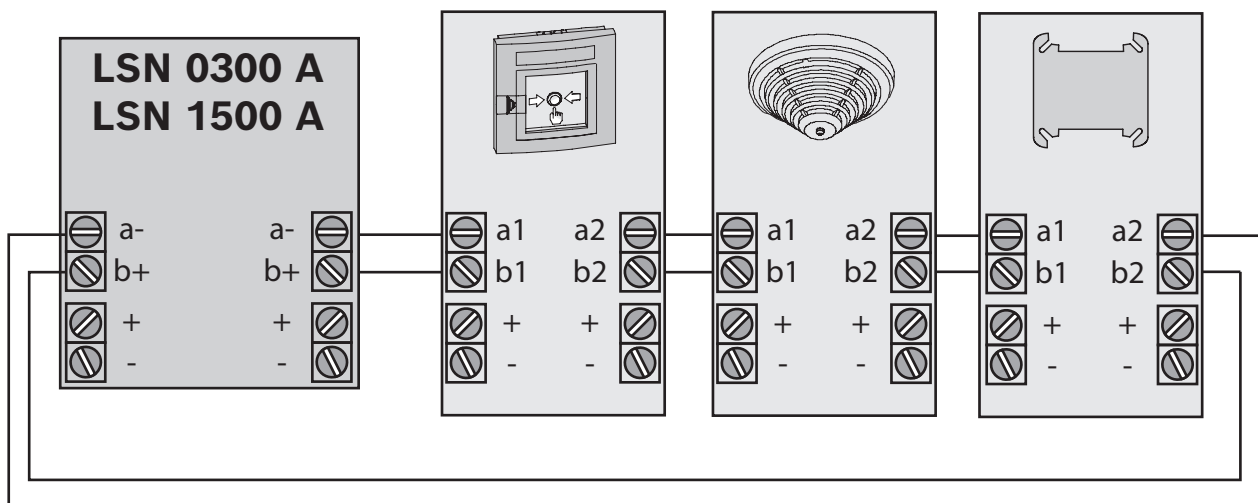
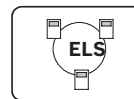

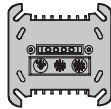
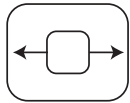

FLM-I 420-S  
 FLM-420-I2-D  
 FLM-420-O1I1-D  
 FLM-420-RHV-D/S  
 FLM-420-RLV1-D

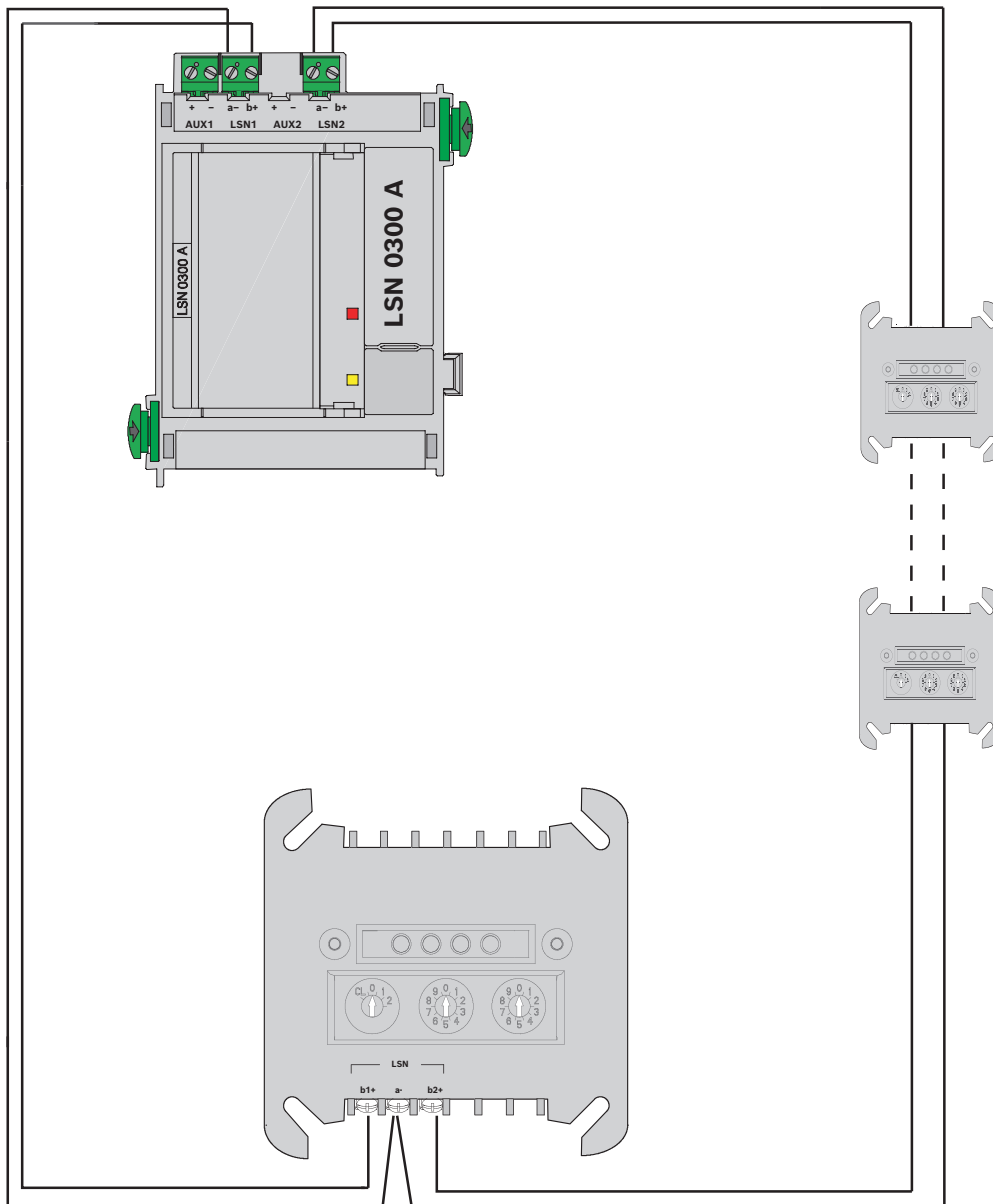
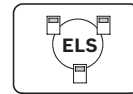

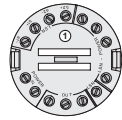
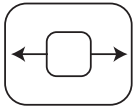

**FLM-420-I2-E/W**  
**FLM-420-RLV1-E**

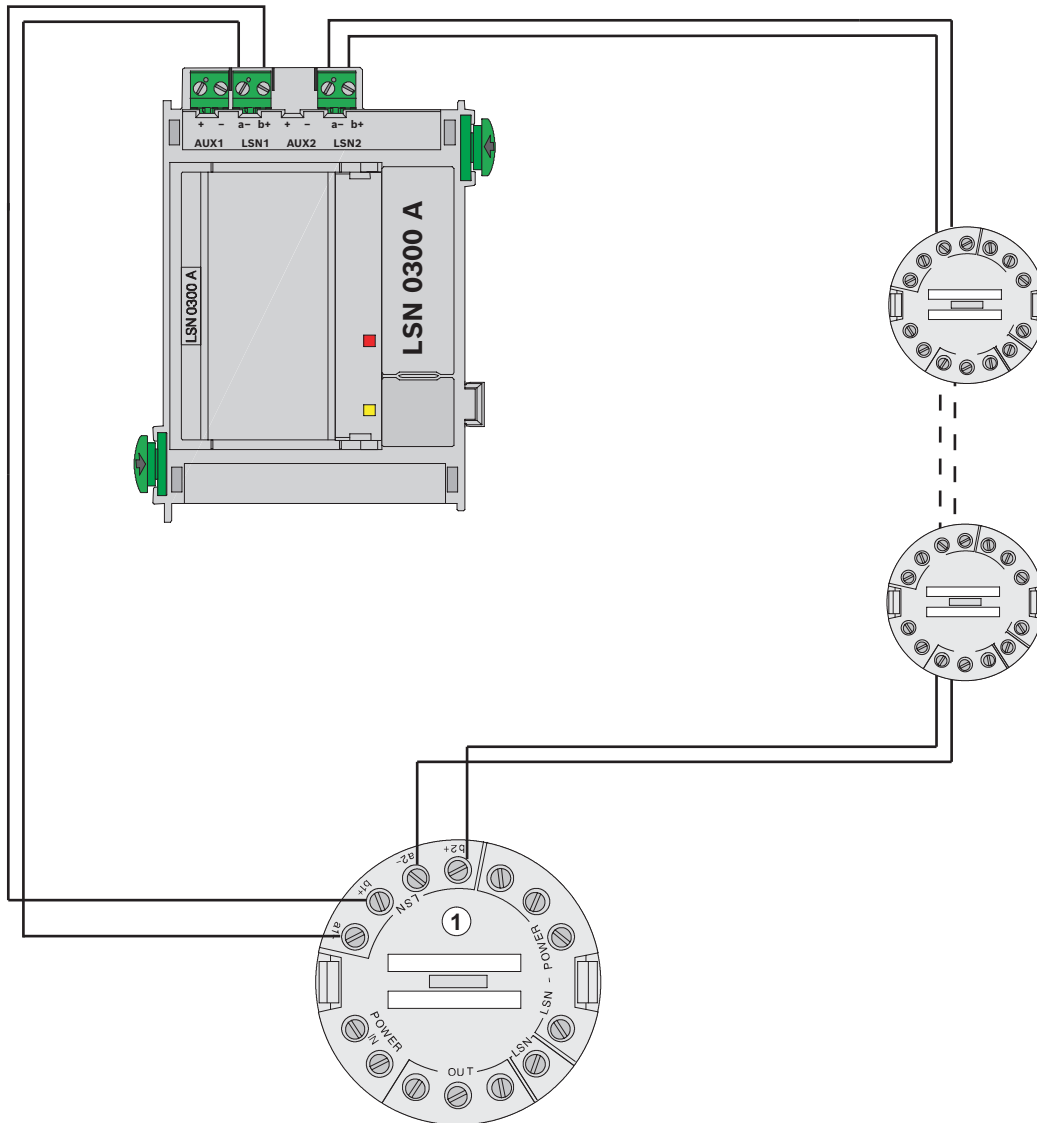
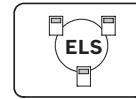

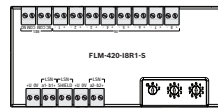
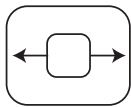

**FLM-420-18R1-S**

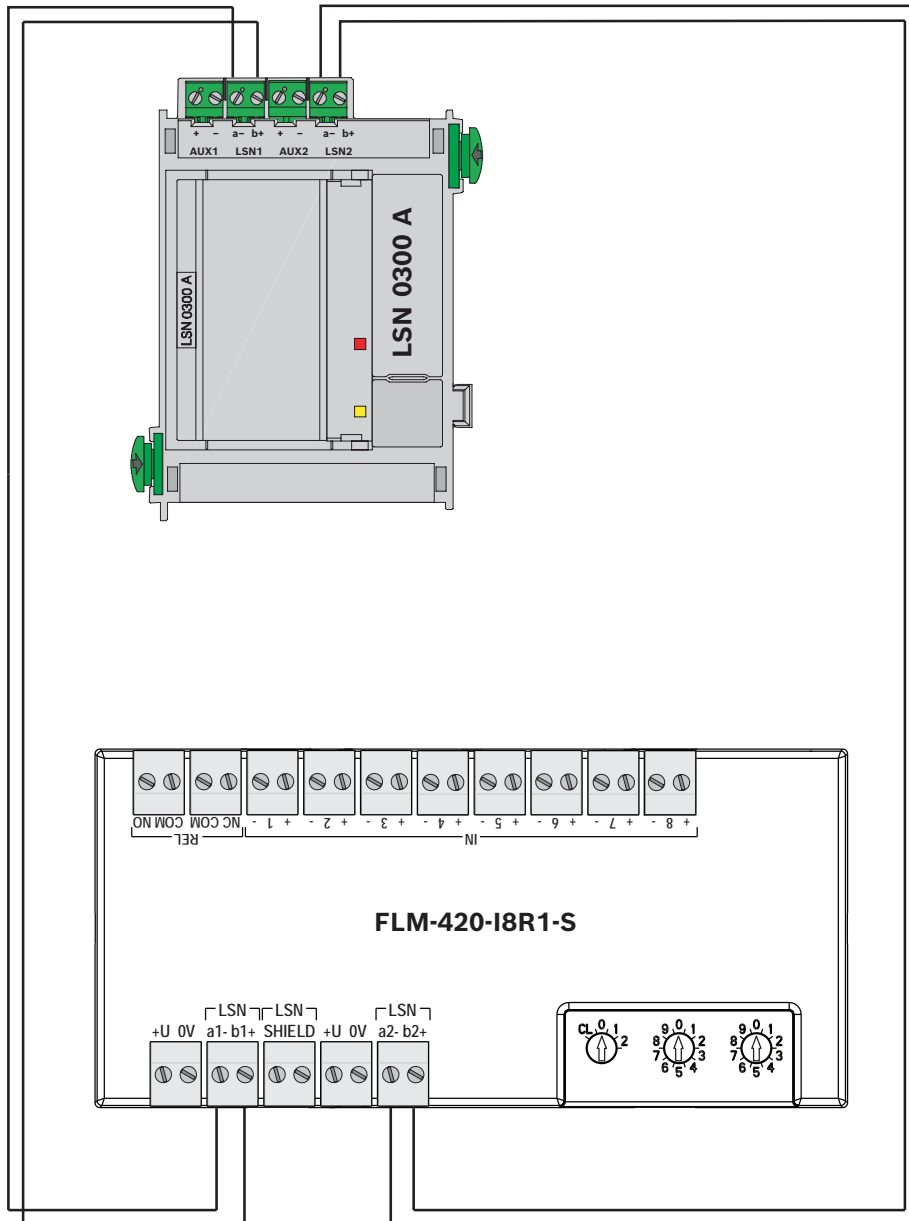
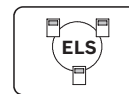

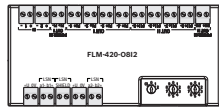
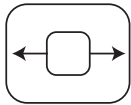

**FLM-420-0812-S**

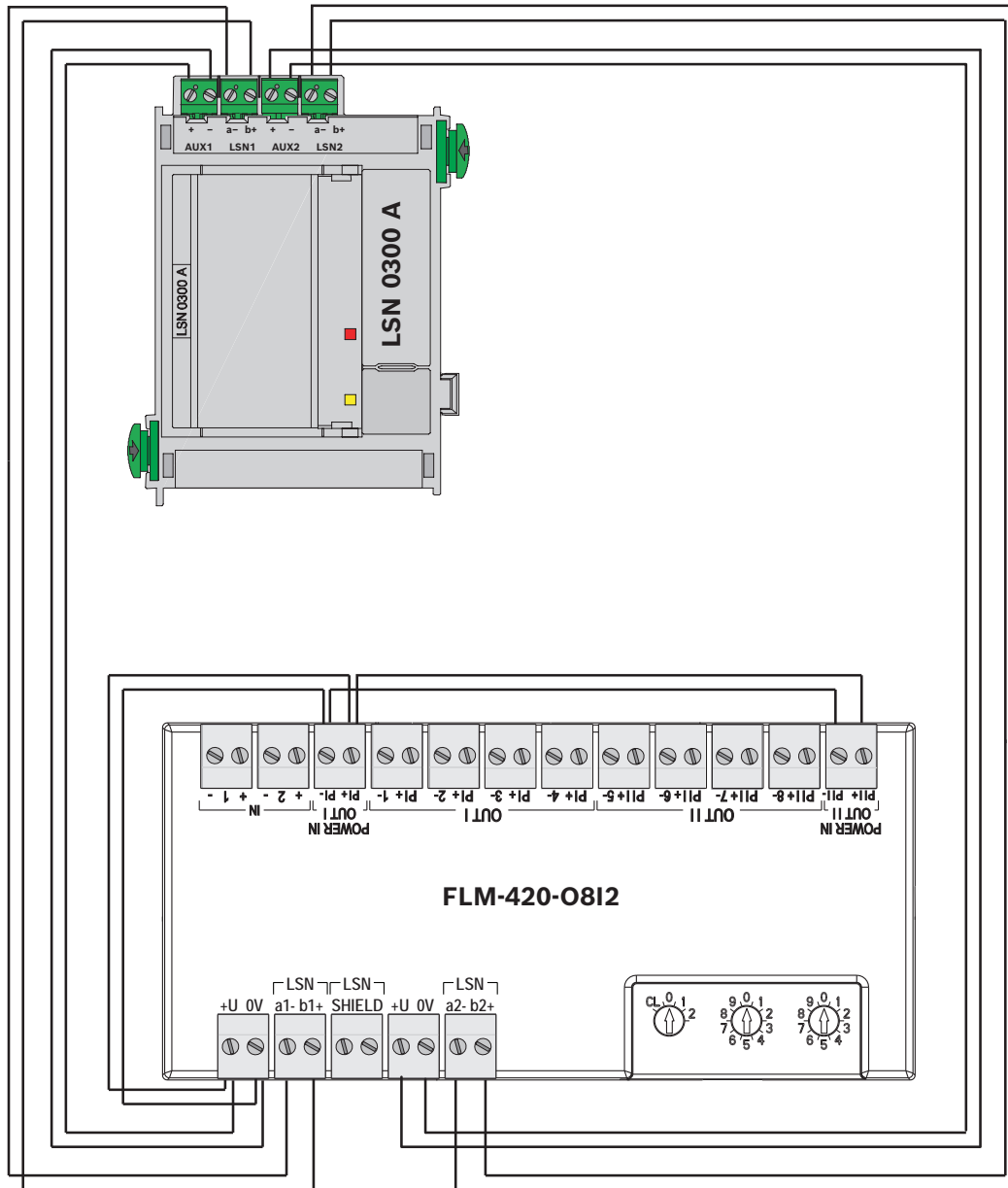
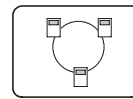



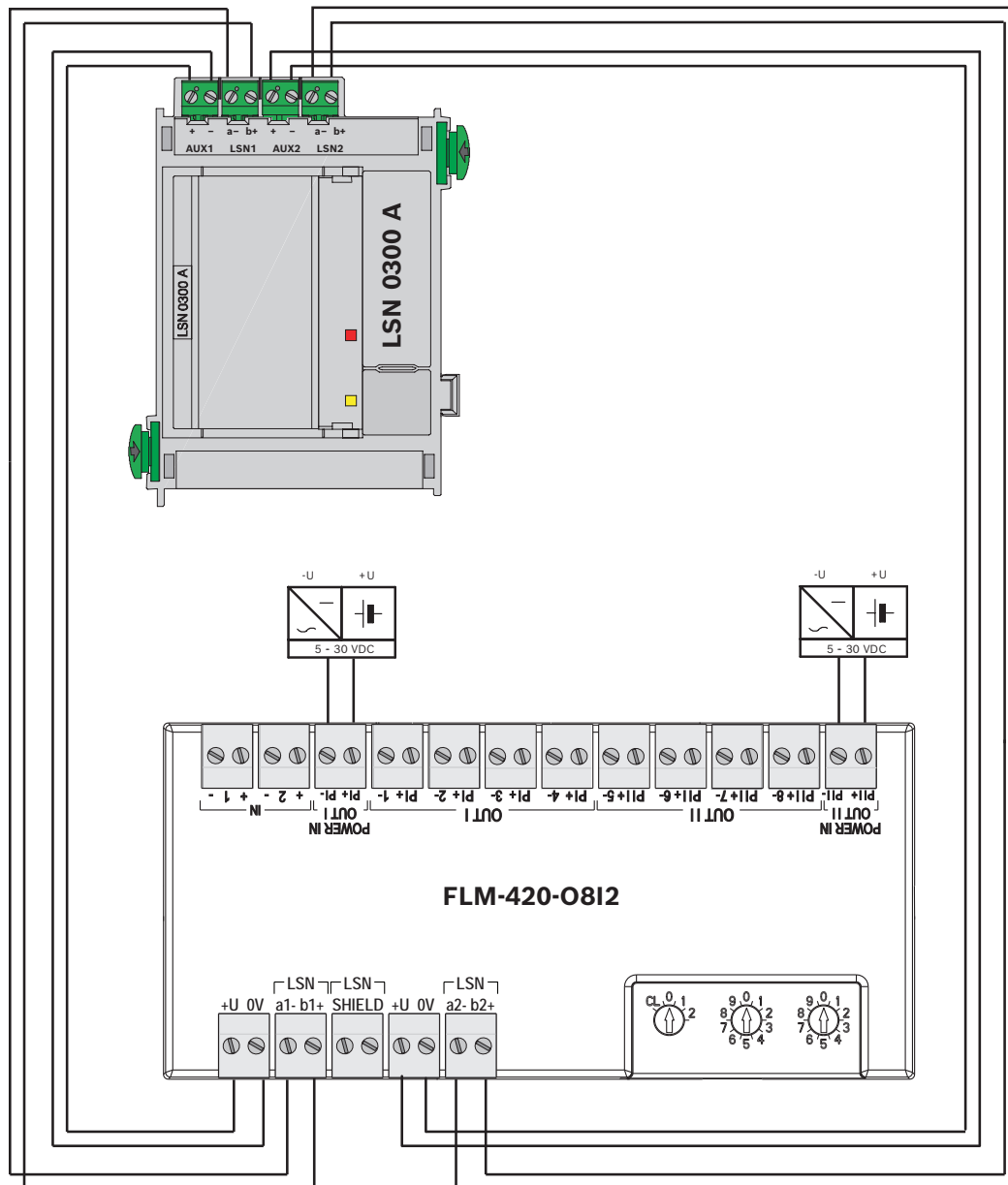
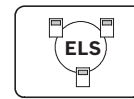
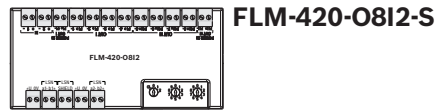
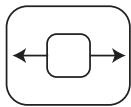

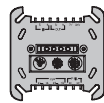
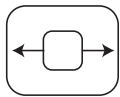

FLM-420-NAC-D/S

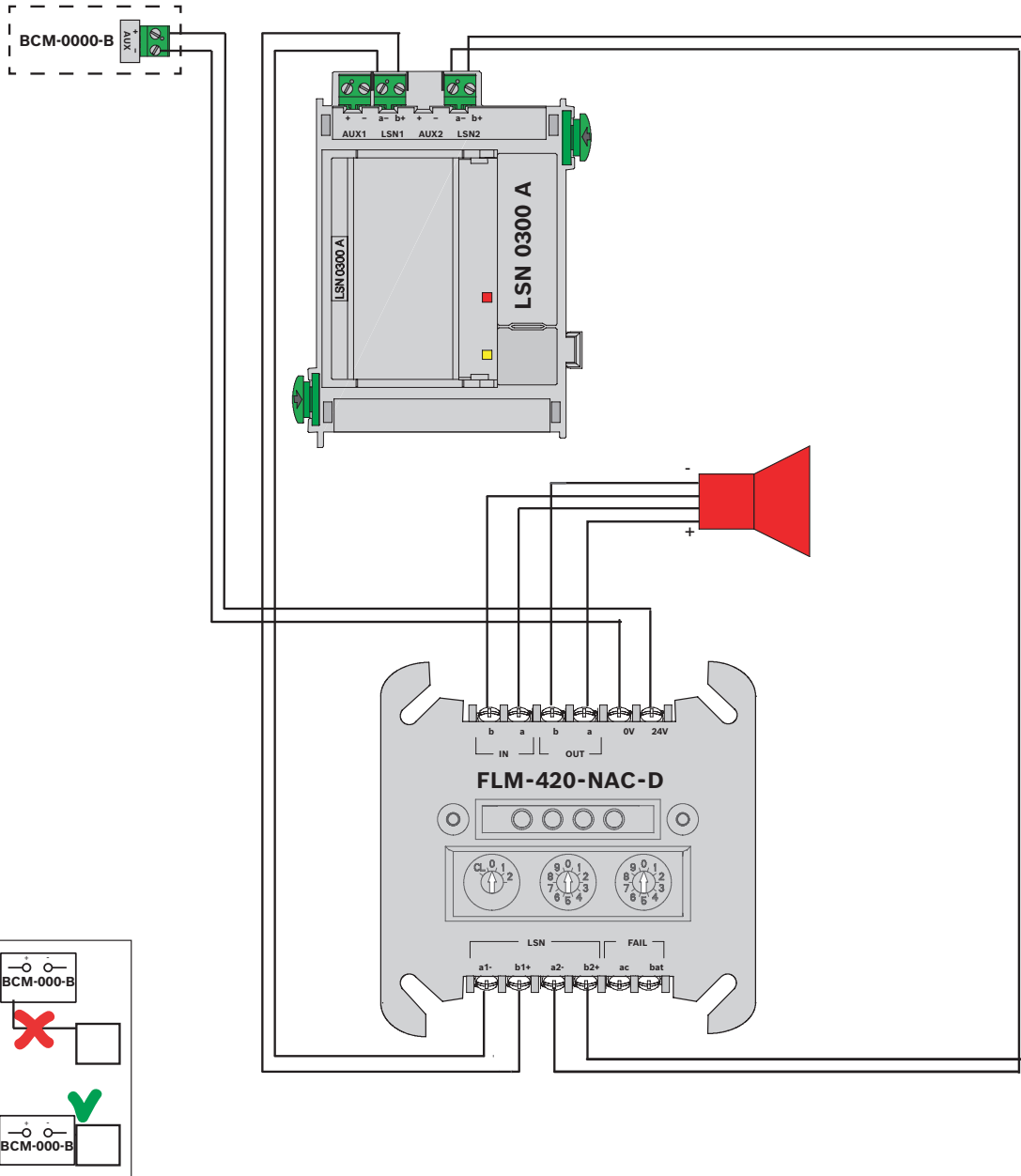
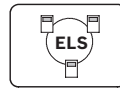

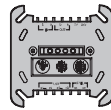
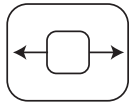

FLM-420-NAC-D/S

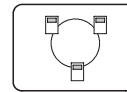

EN 54-2

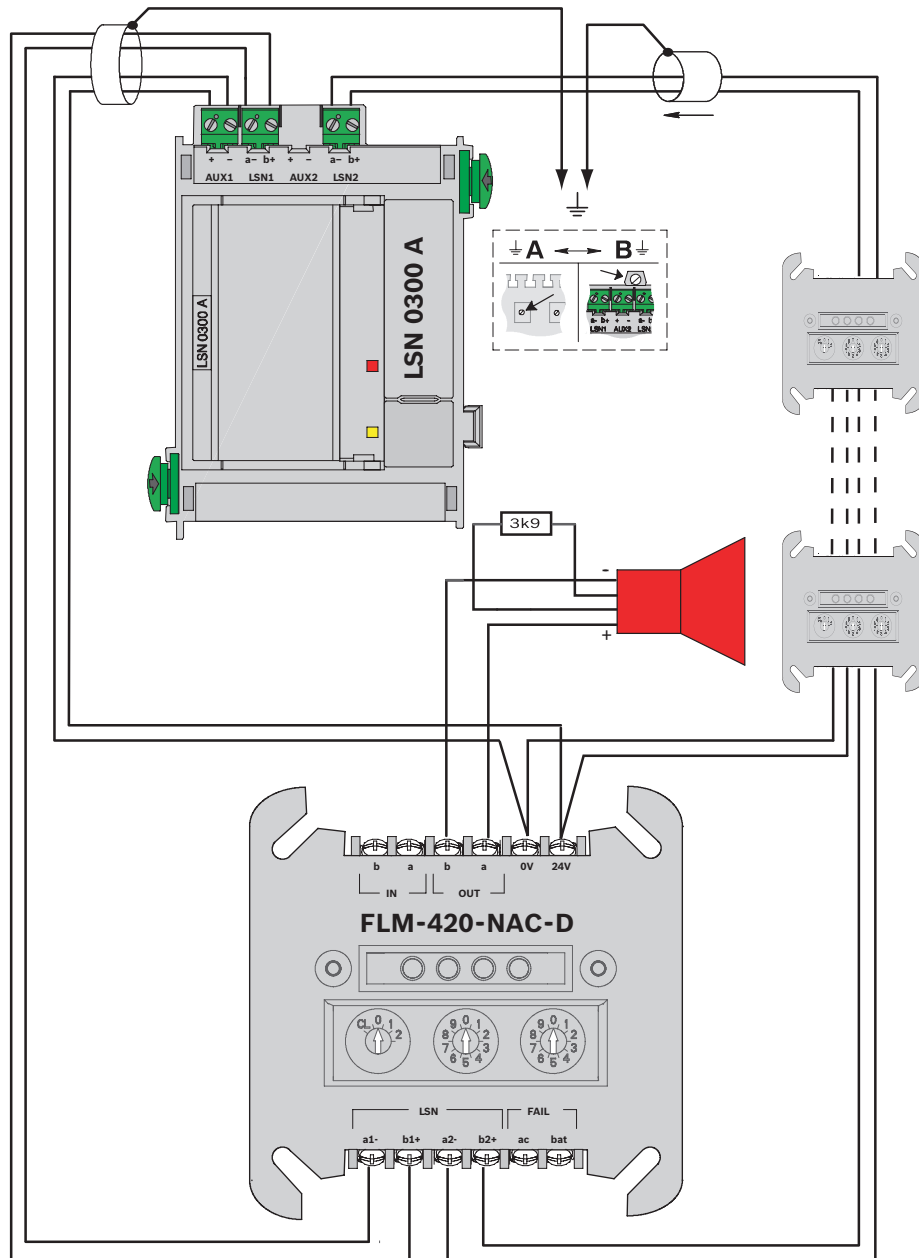

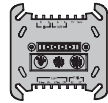
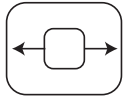

FLM-420-NAC-D/S

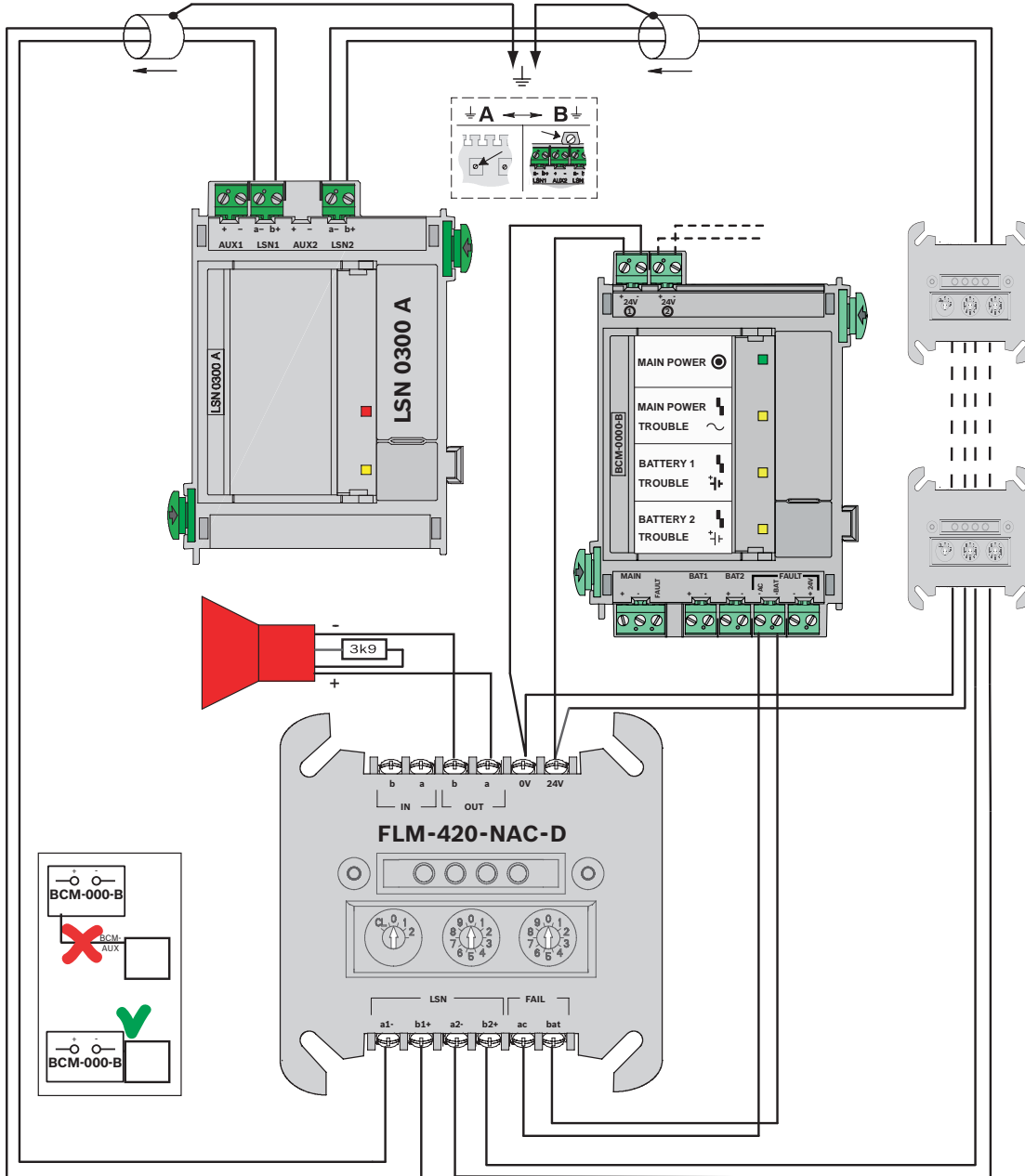
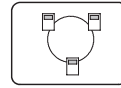

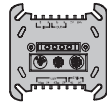
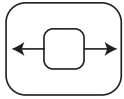

FLM-420-RLE-S

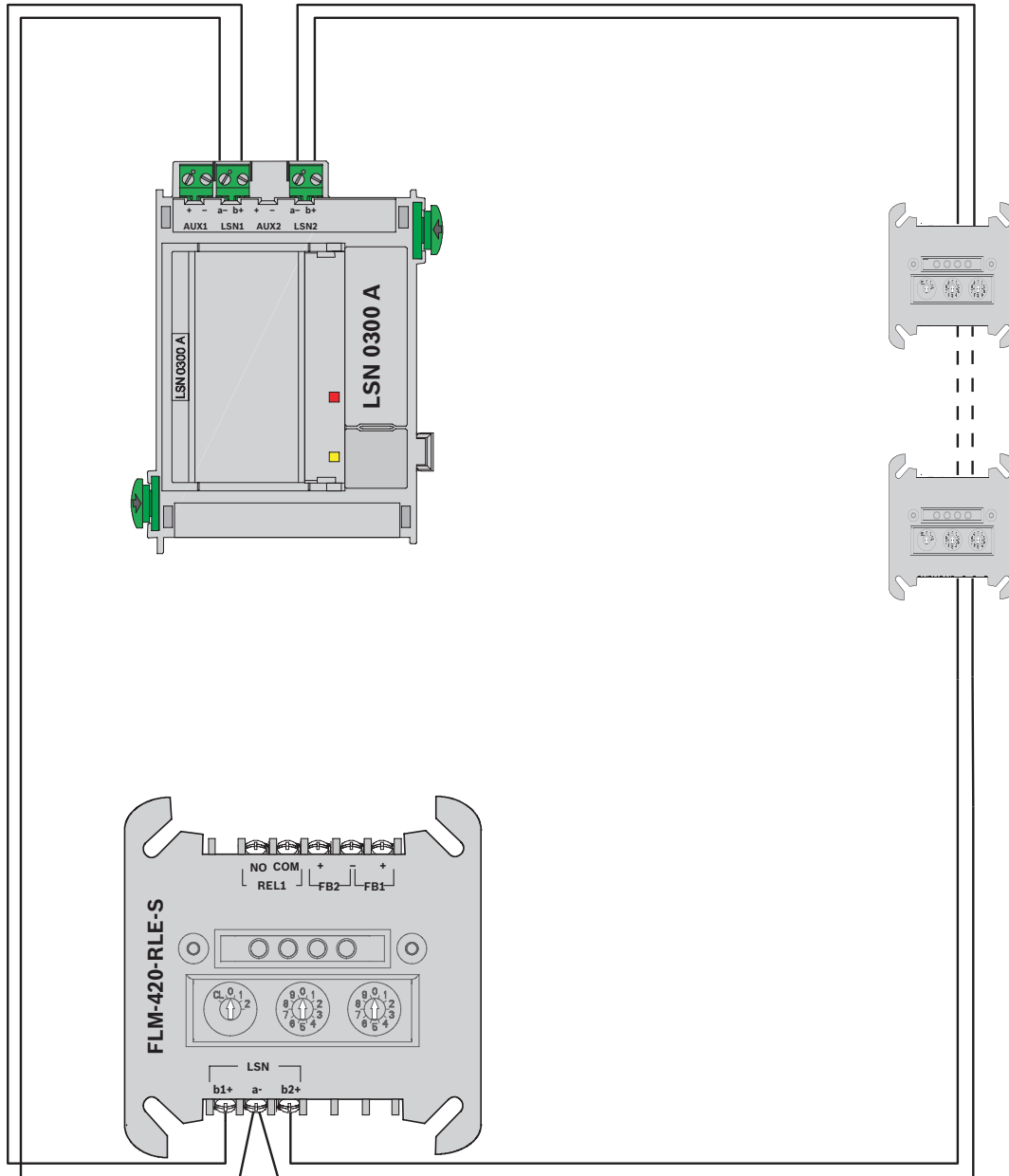
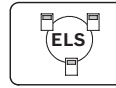

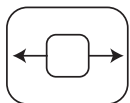

**FLM-420-O111-D**

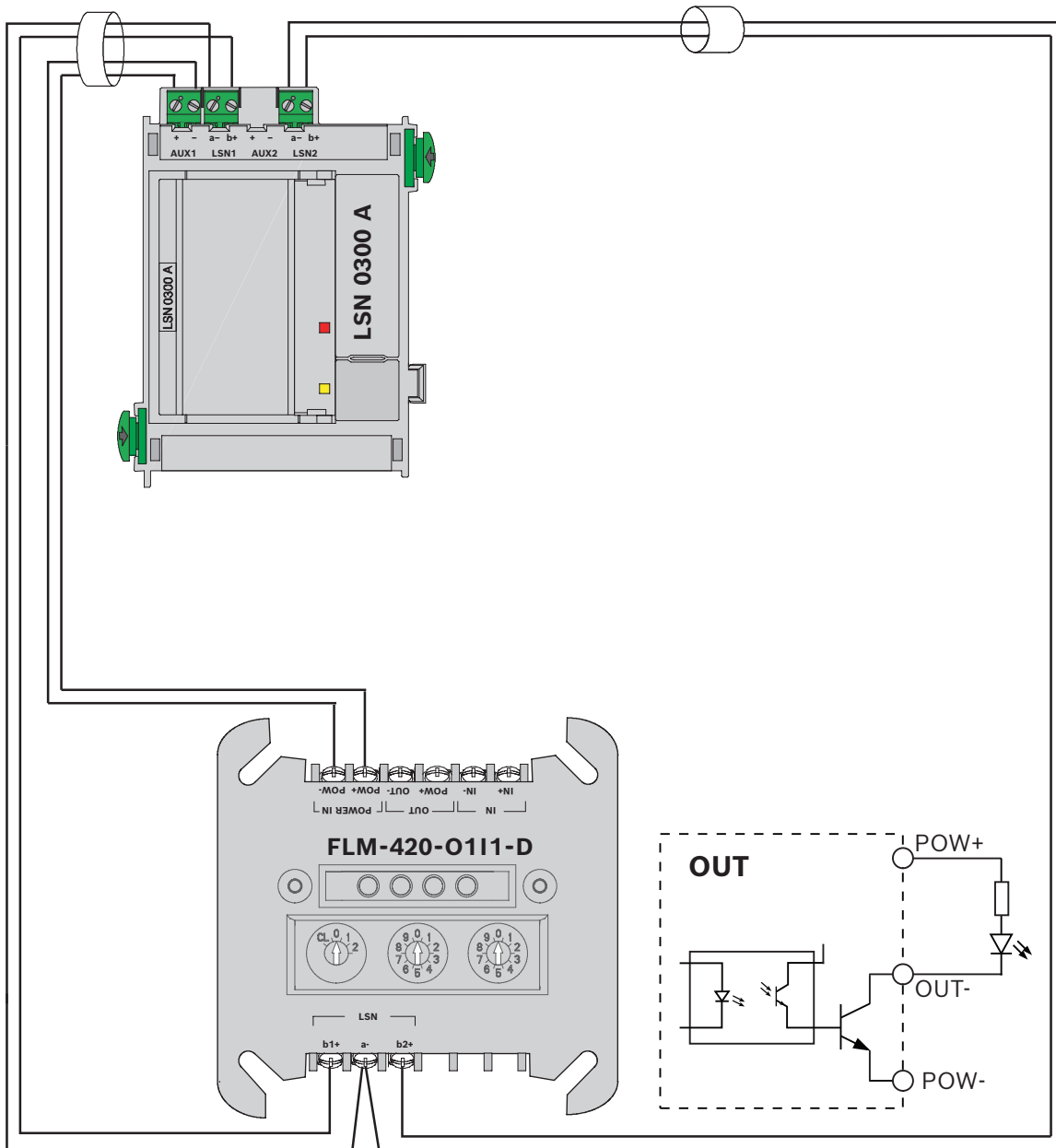
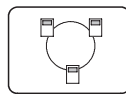

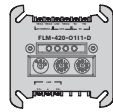
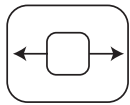

**FLM-420-O111-D**

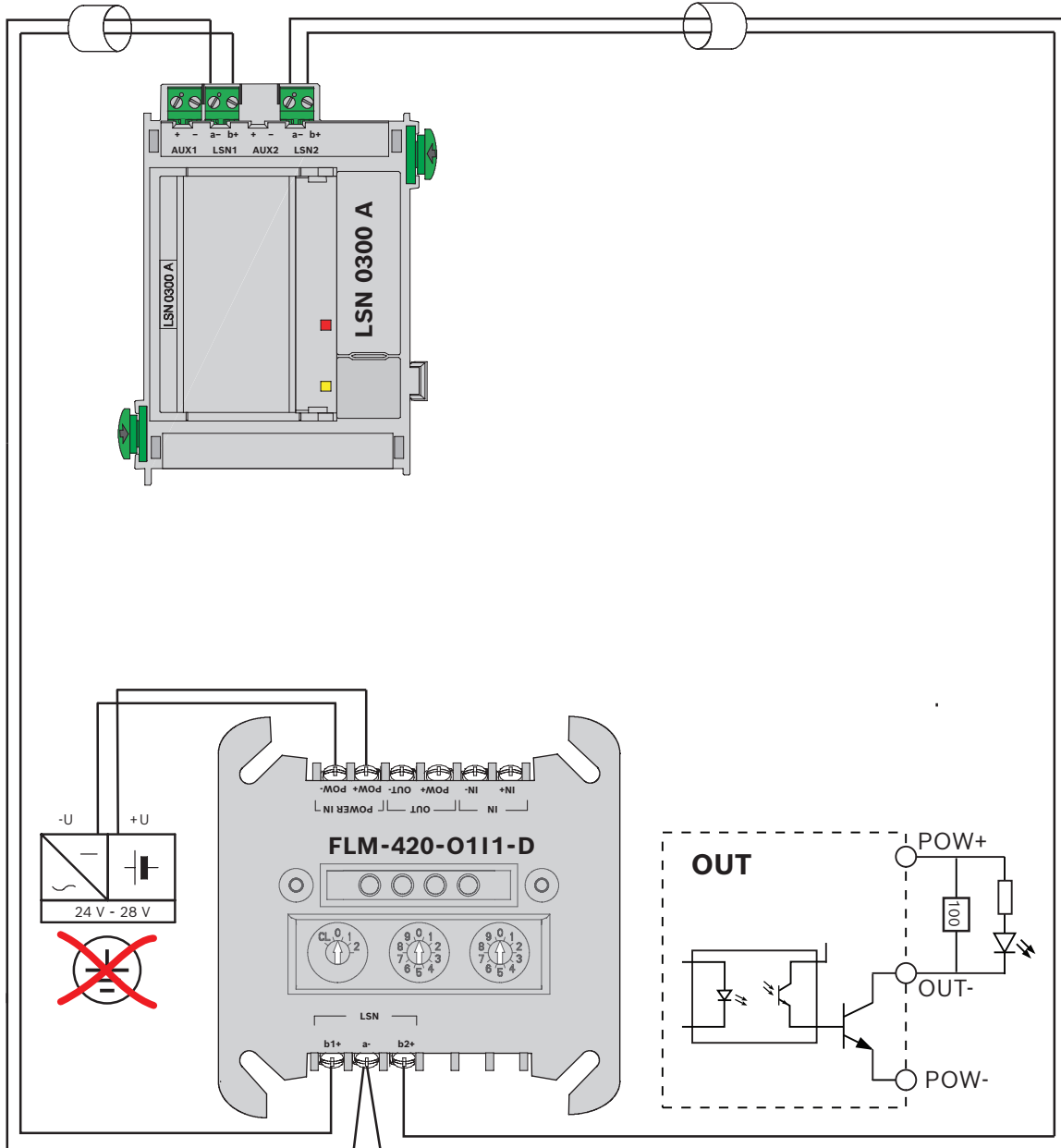
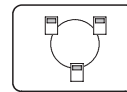

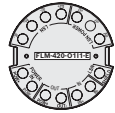
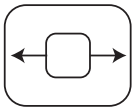

**FLM-420-O111-E**

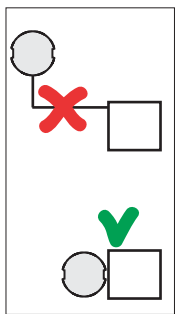
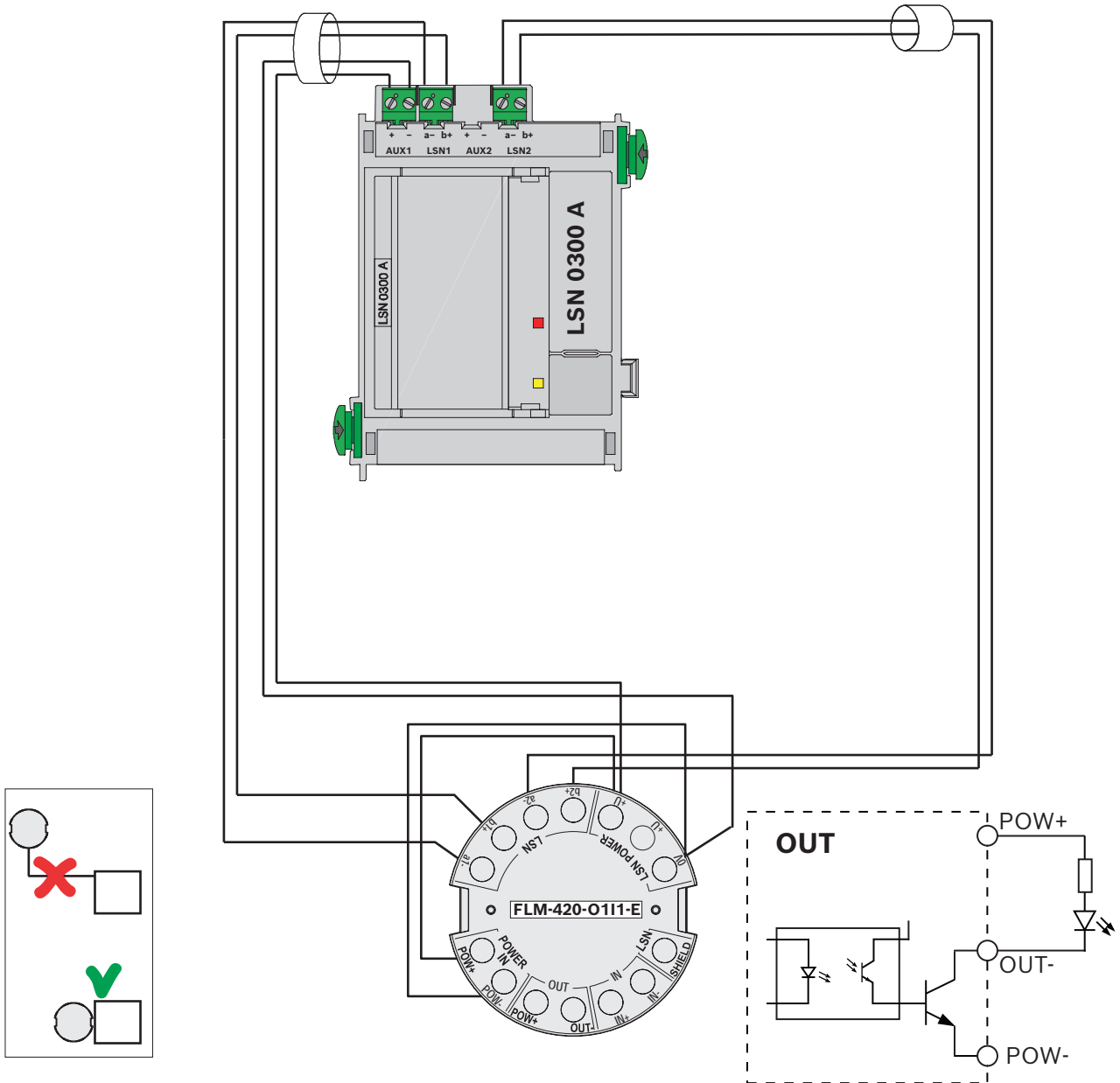
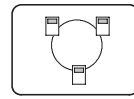



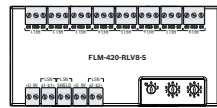
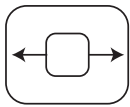

**FLM-420-RLV8-S**

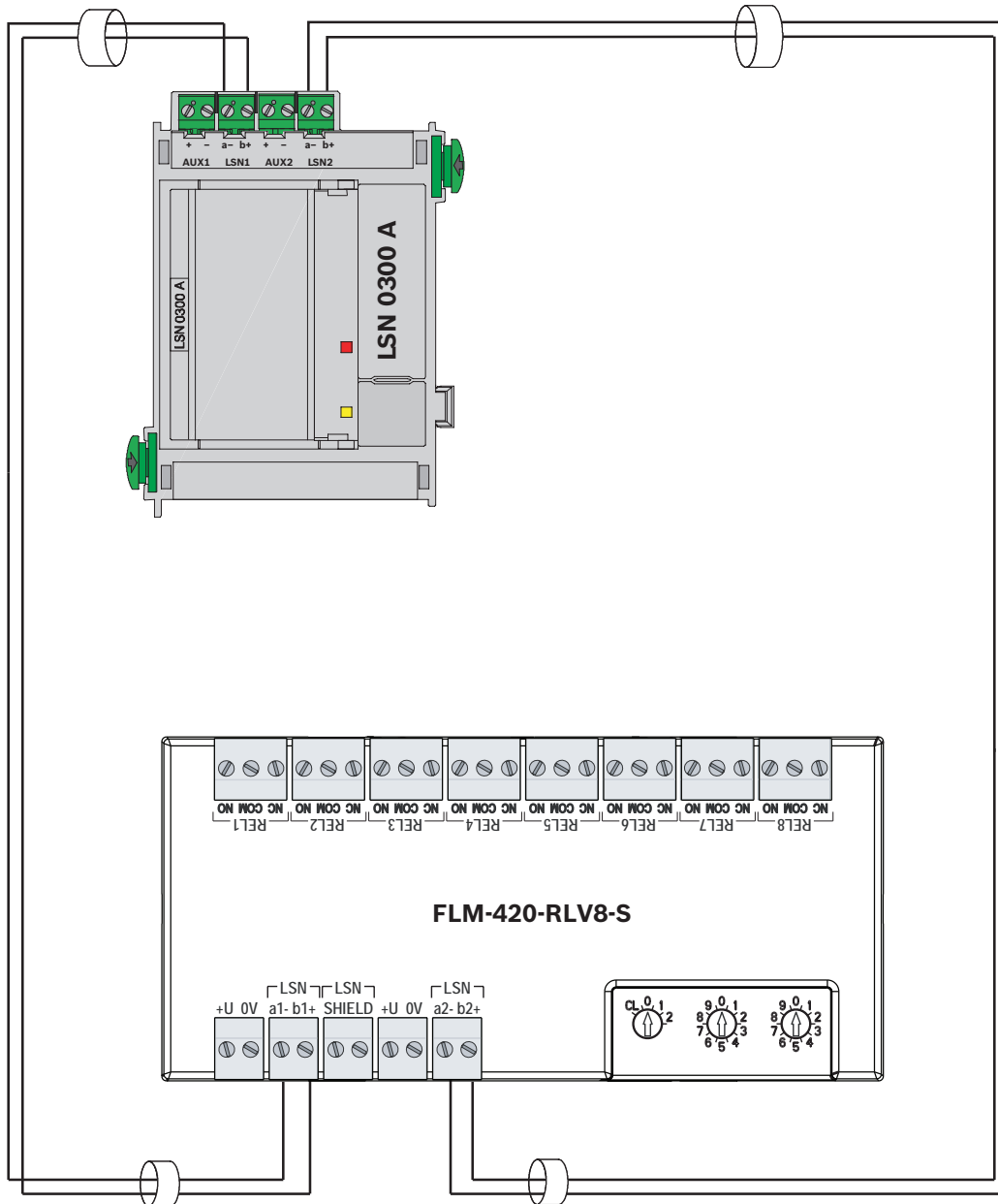
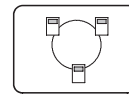



FAD-0420

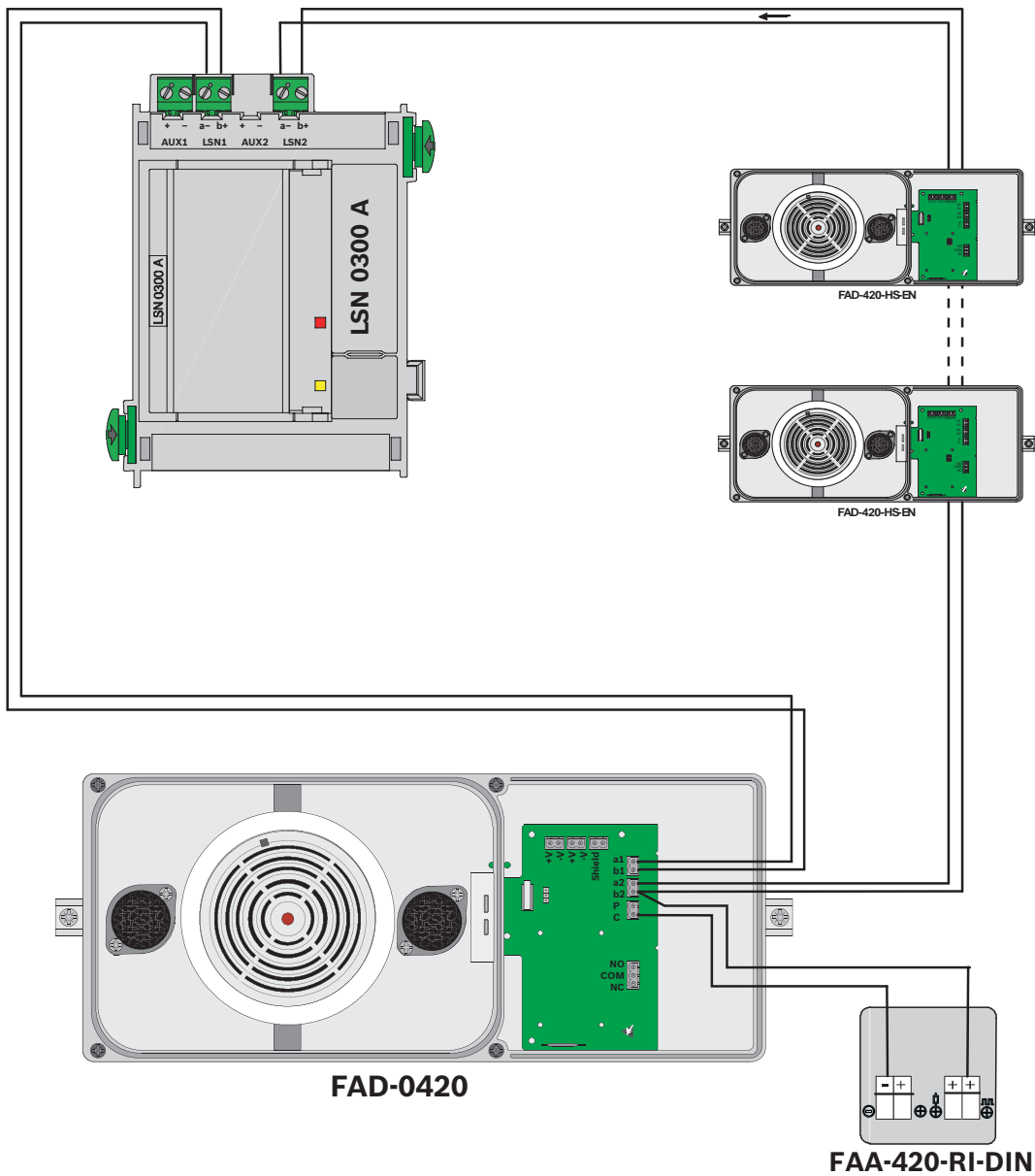



**FAD-420-HS-EN**

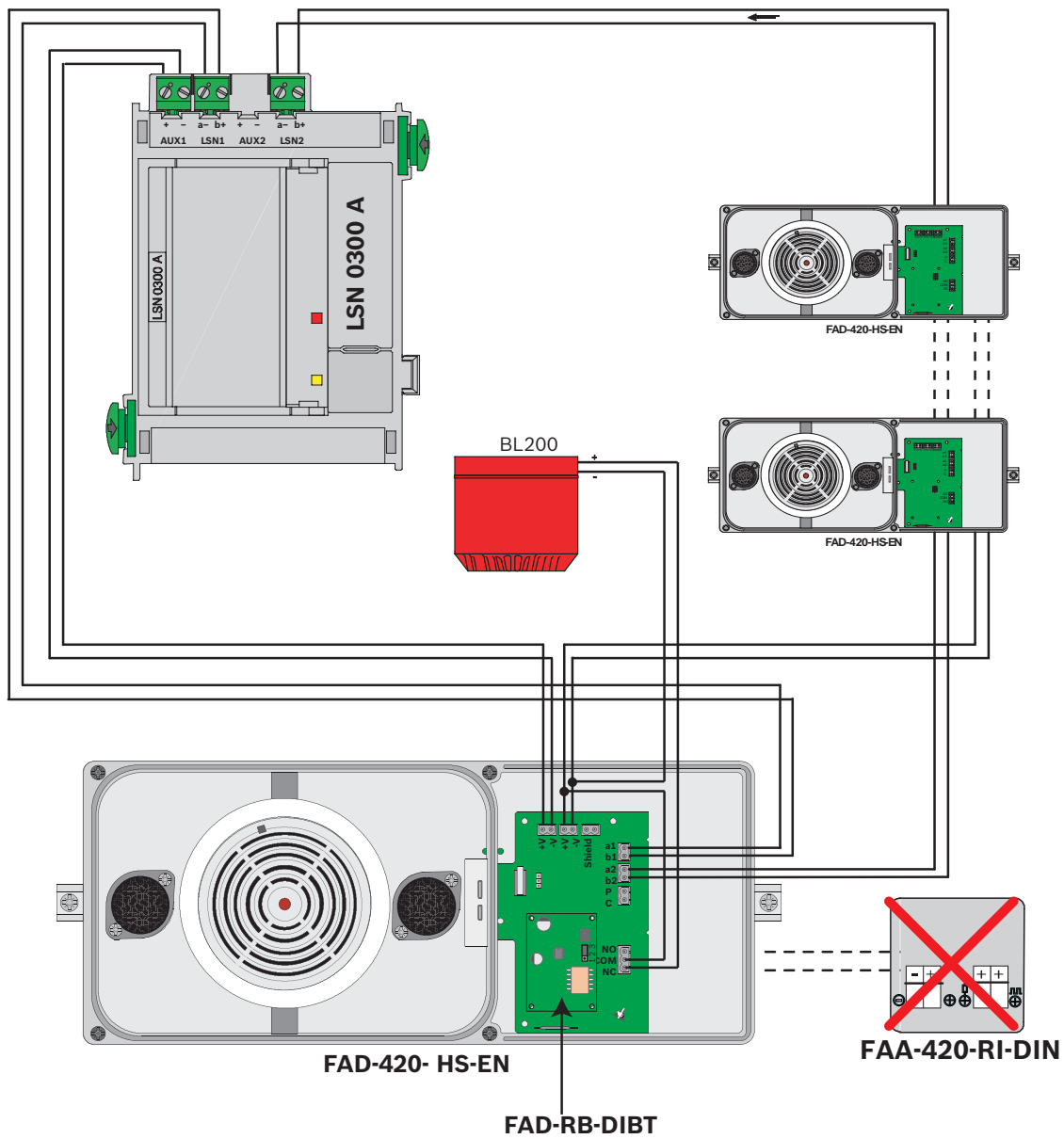

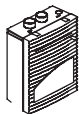

**FAS-420 Series**

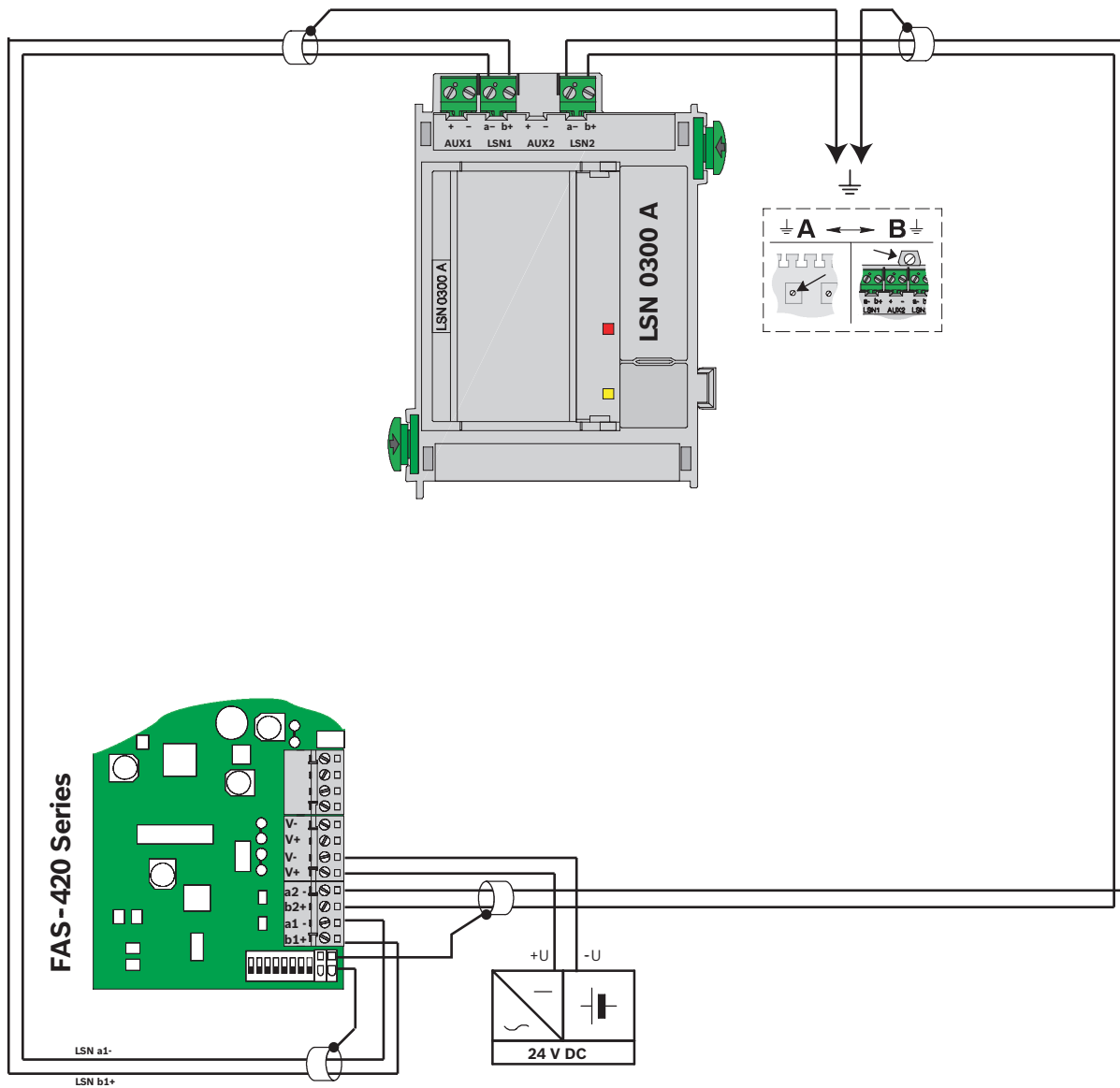

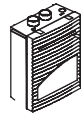

FAS-420-TM Series

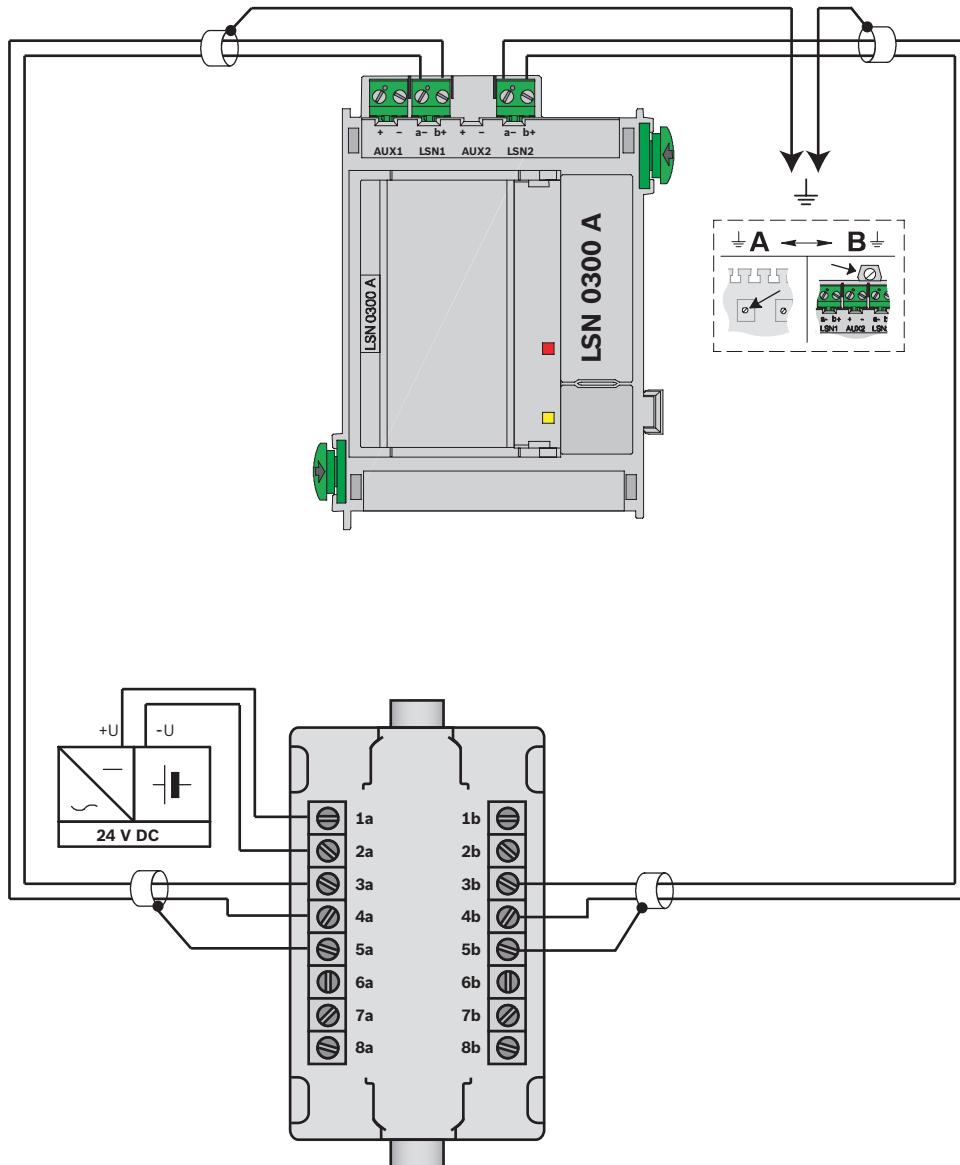

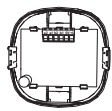

**FNM-420-A / -B**  
**FNM-420U-A / -B**  
**FNM-420V-A**

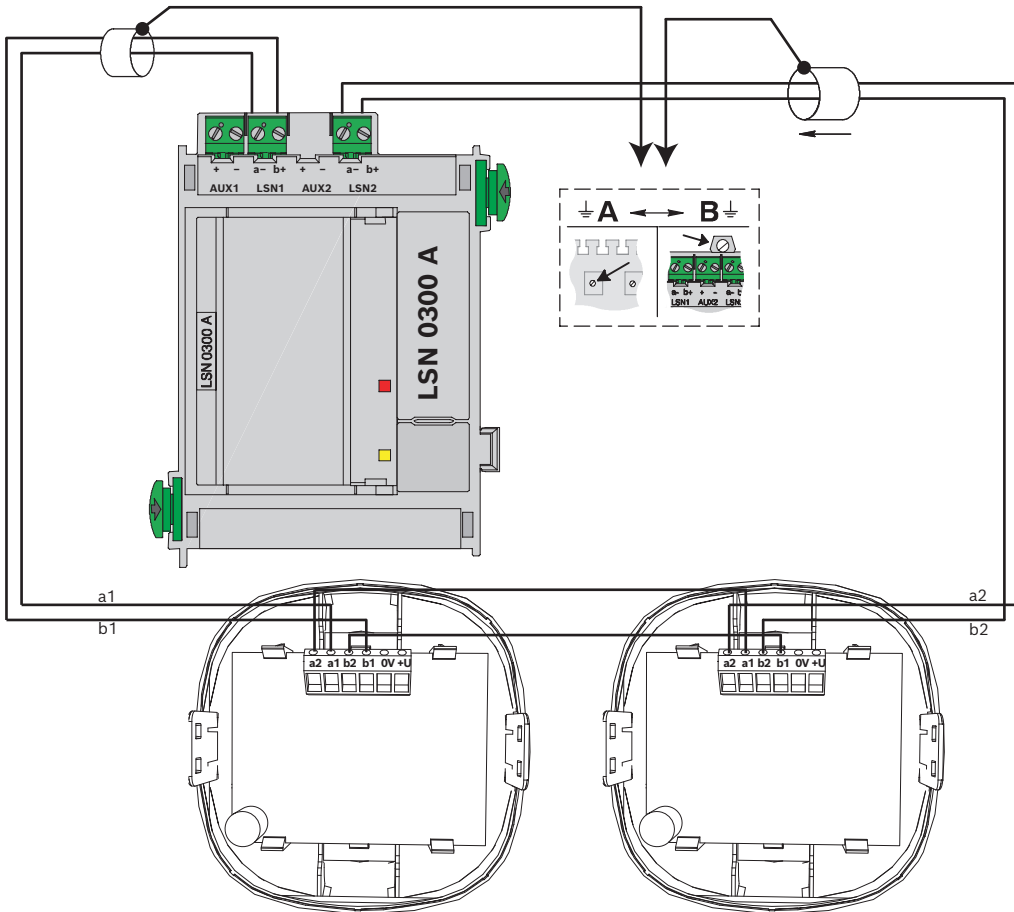
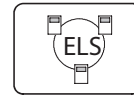

**FNM-420-A/-B**  
**FNM-420U-A/-B**  
**FNM-420V-A**

**FNM-420-A/-B**  
**FNM-420U-A/B**  
**FNM-420V-A**



**FNM-420-A-BS**  
**FNM-420U-A-BS**

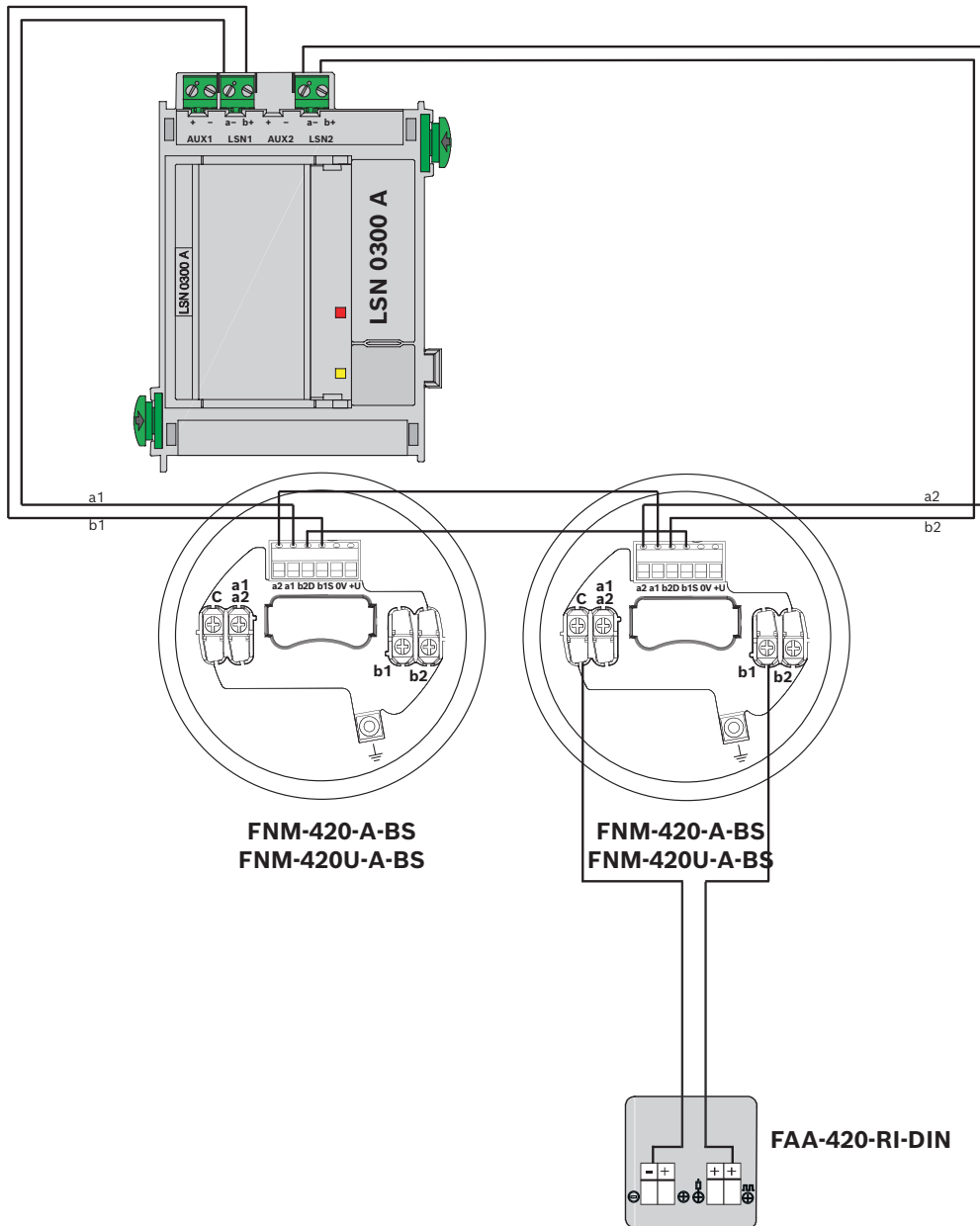
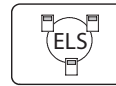

**FNM-420-A-BS**  
**FNM-420U-A-BS**

**FNM-420-A-BS**  
**FNM-420U-A-BS**

**FAA-420-RI-DIN**



**FNM-420-A-BS**  
**FNM-420U-A-BS**

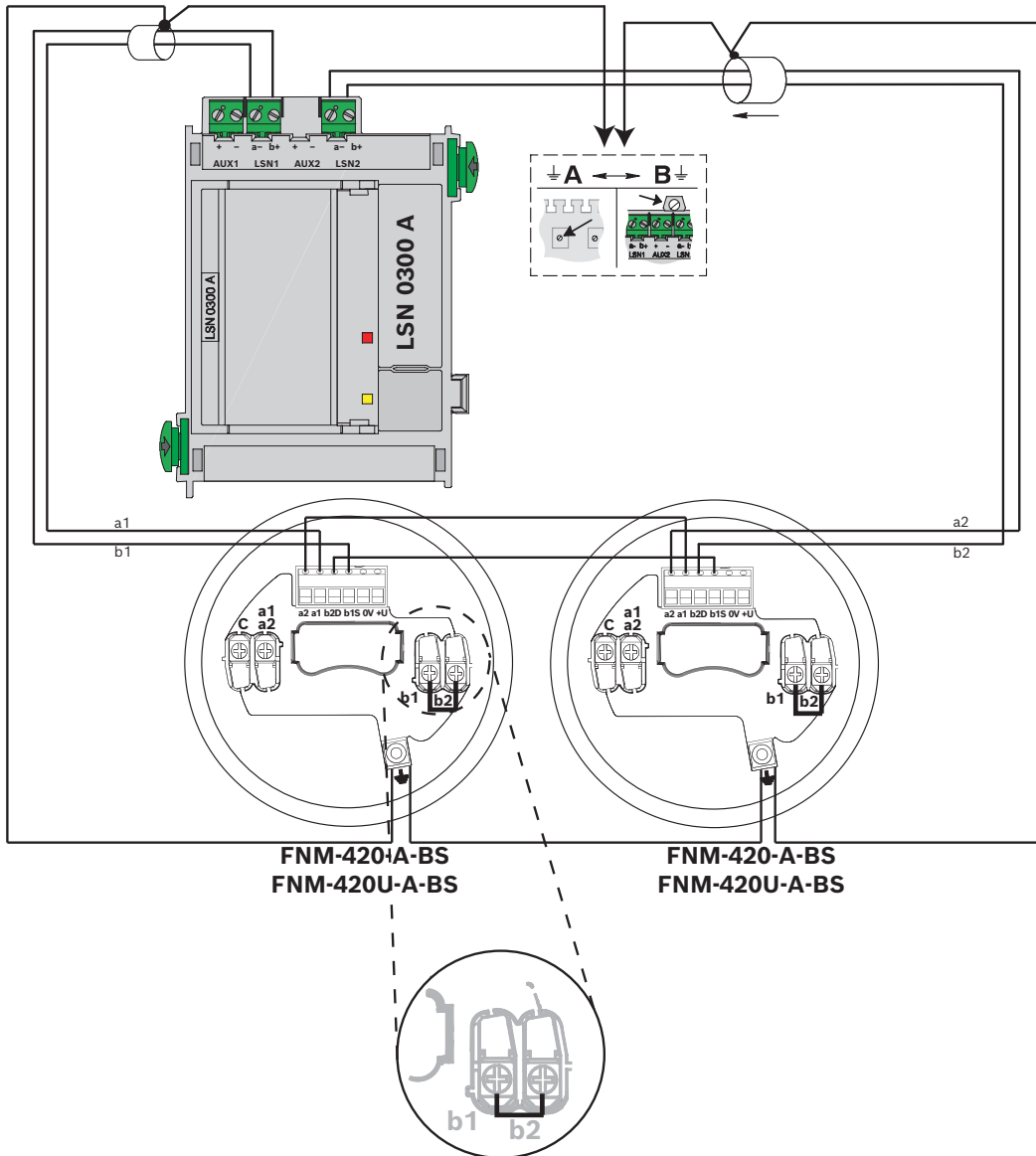
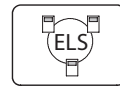



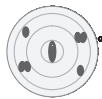

FAP-0520  
FAP-0520-P  
FAP-OC520  
FAP-OC-520-P

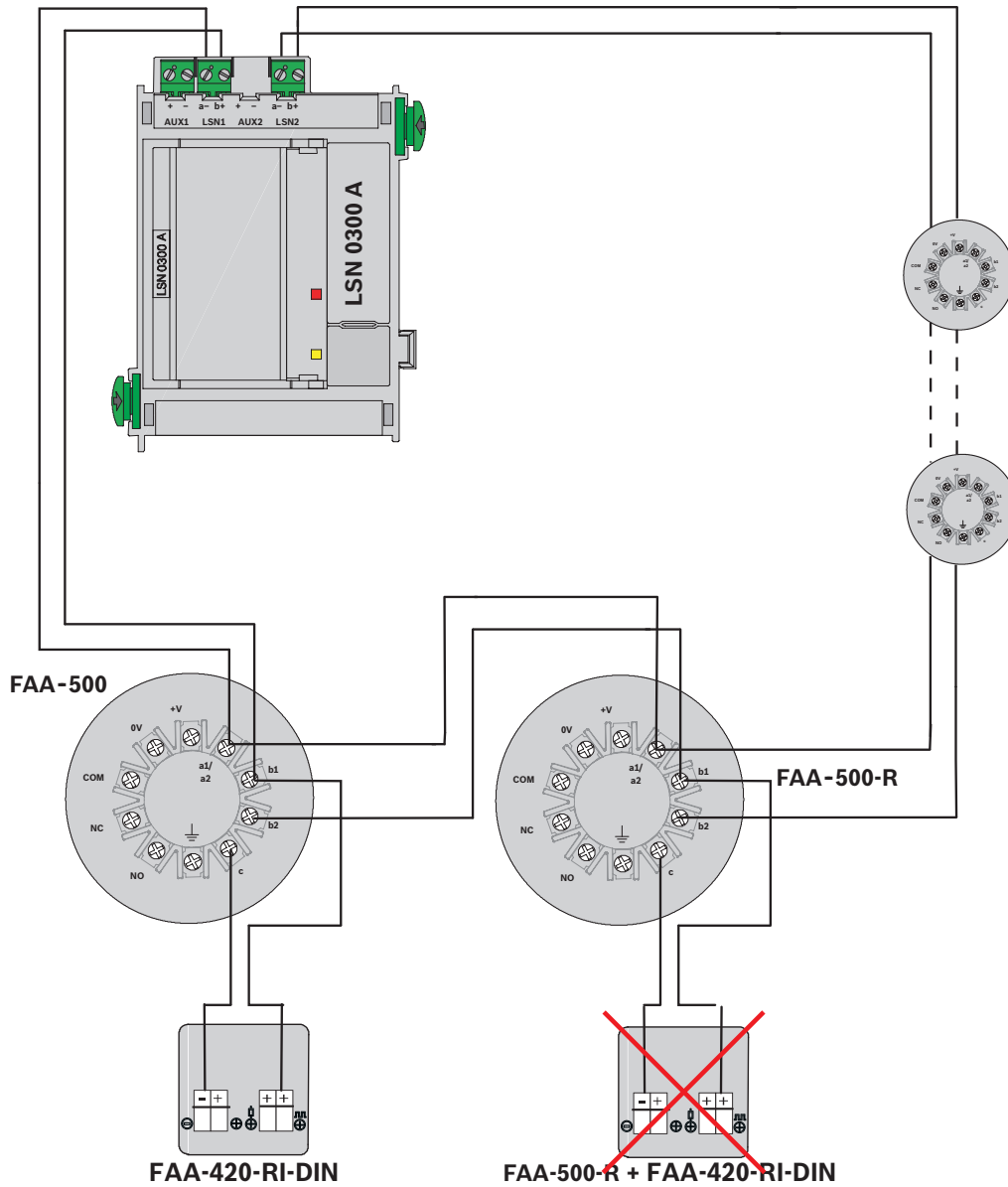
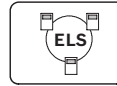

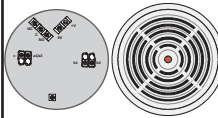

**FAA-MSR-420**  
**FAP-425-O, FAP-425-O-R**  
**FAP-425-OT, FAP-425-OT-R**  
**FAP-425-T-R**  
**FAP-425-DO-R, FAP-425-DOT-R**  
**FAP-425-DOTC-R, FAP-425-DOTCO-R**

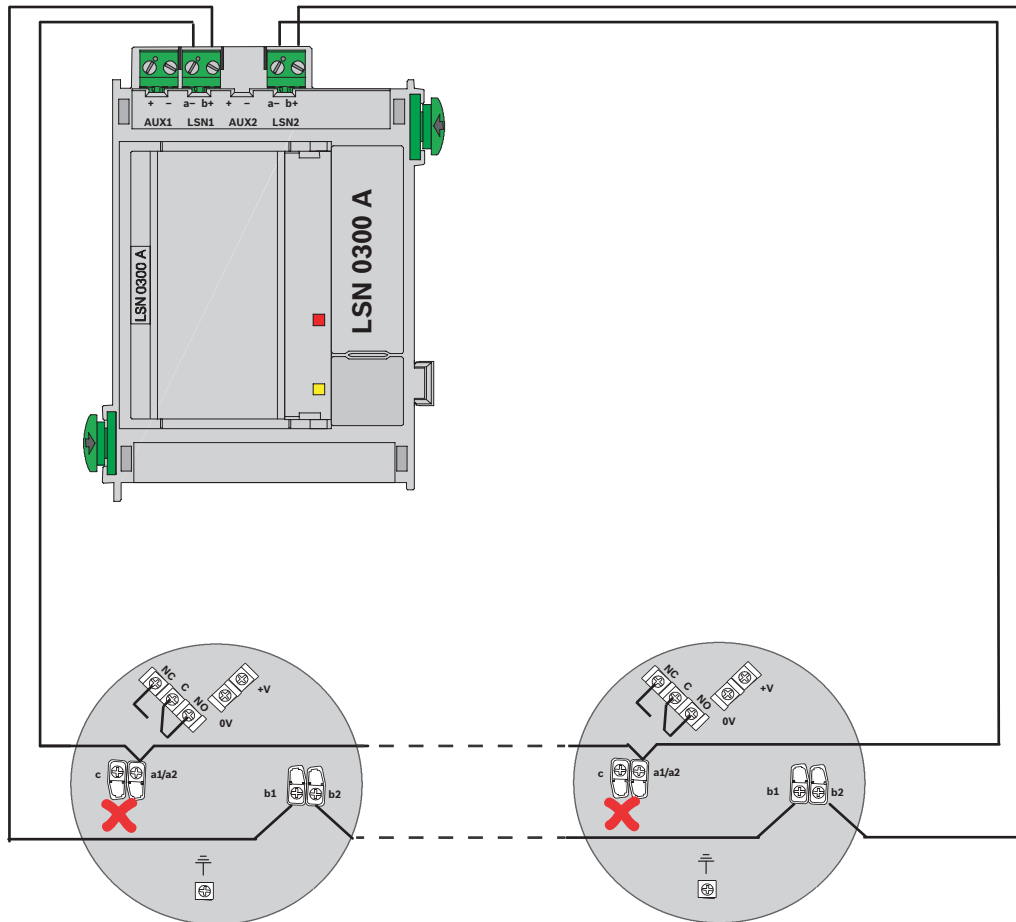
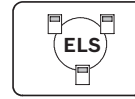

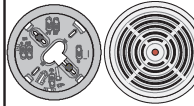

MS 400, MS 400 B  
 FAP-425-O, FAP-425-O-R  
 FAP-425-OT, FAP-425-OT-R  
 FAP-425-T-R  
 FAP-425-DO-R, FAP-425-DOT-R  
 FAP-425-DOTC-R, FAP-425-DOTCO-R

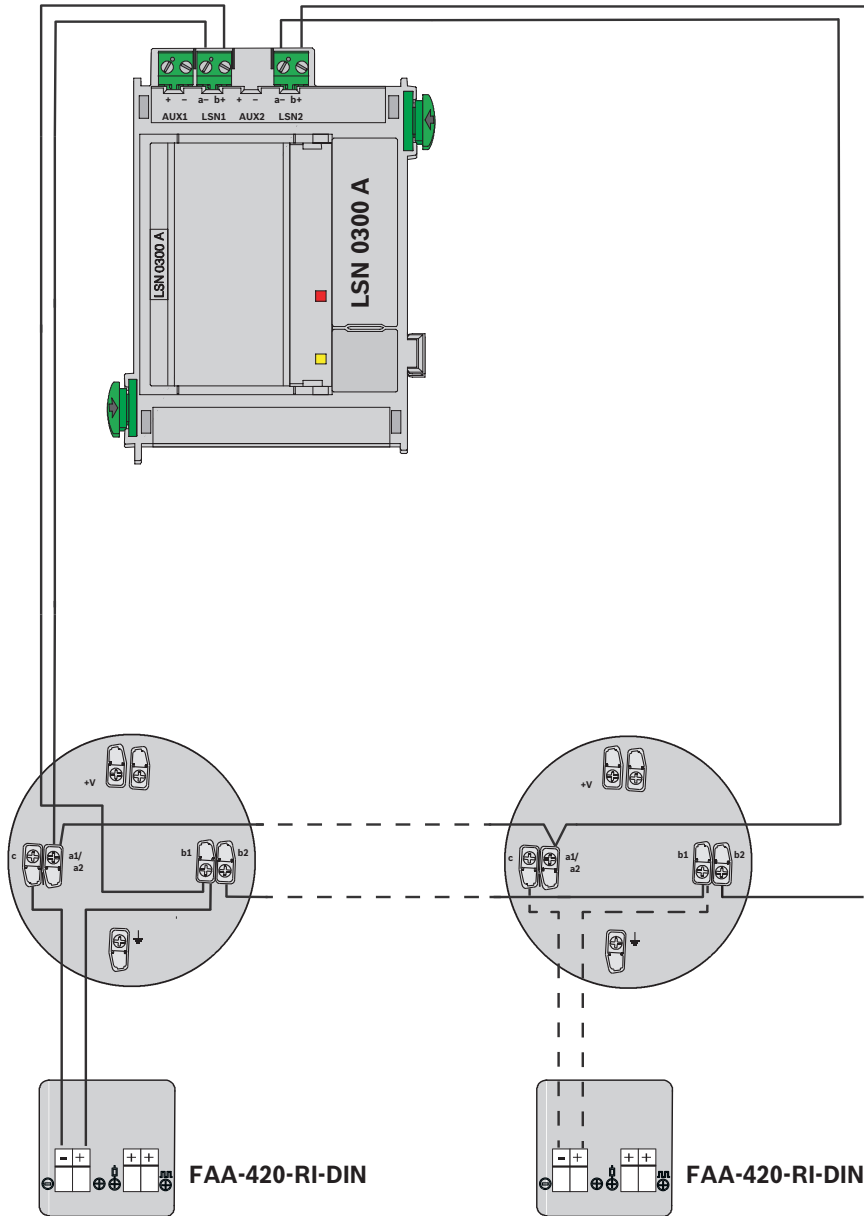
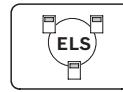

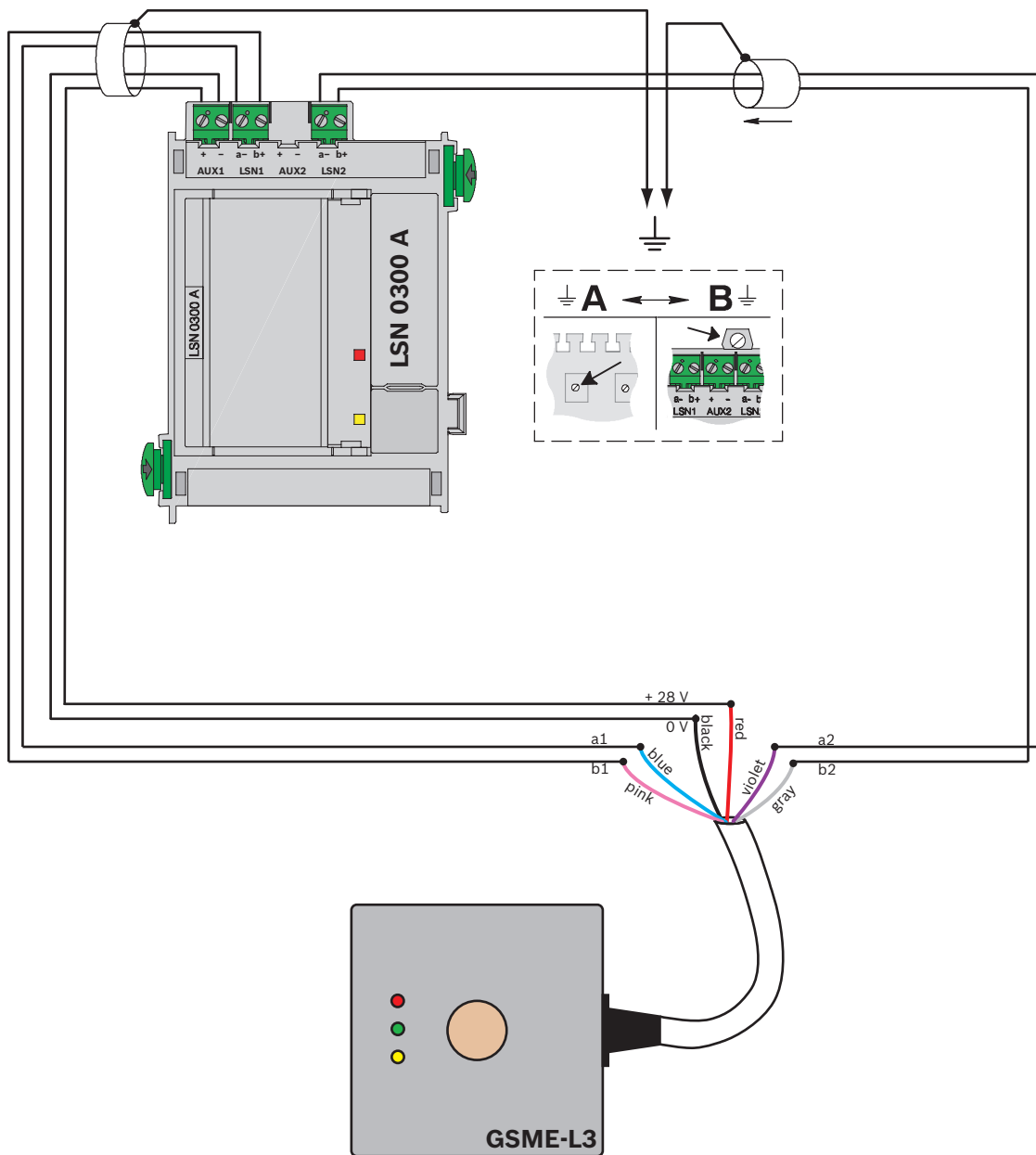
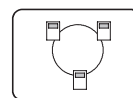

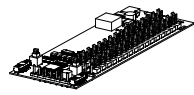

ATB 420 LSNi

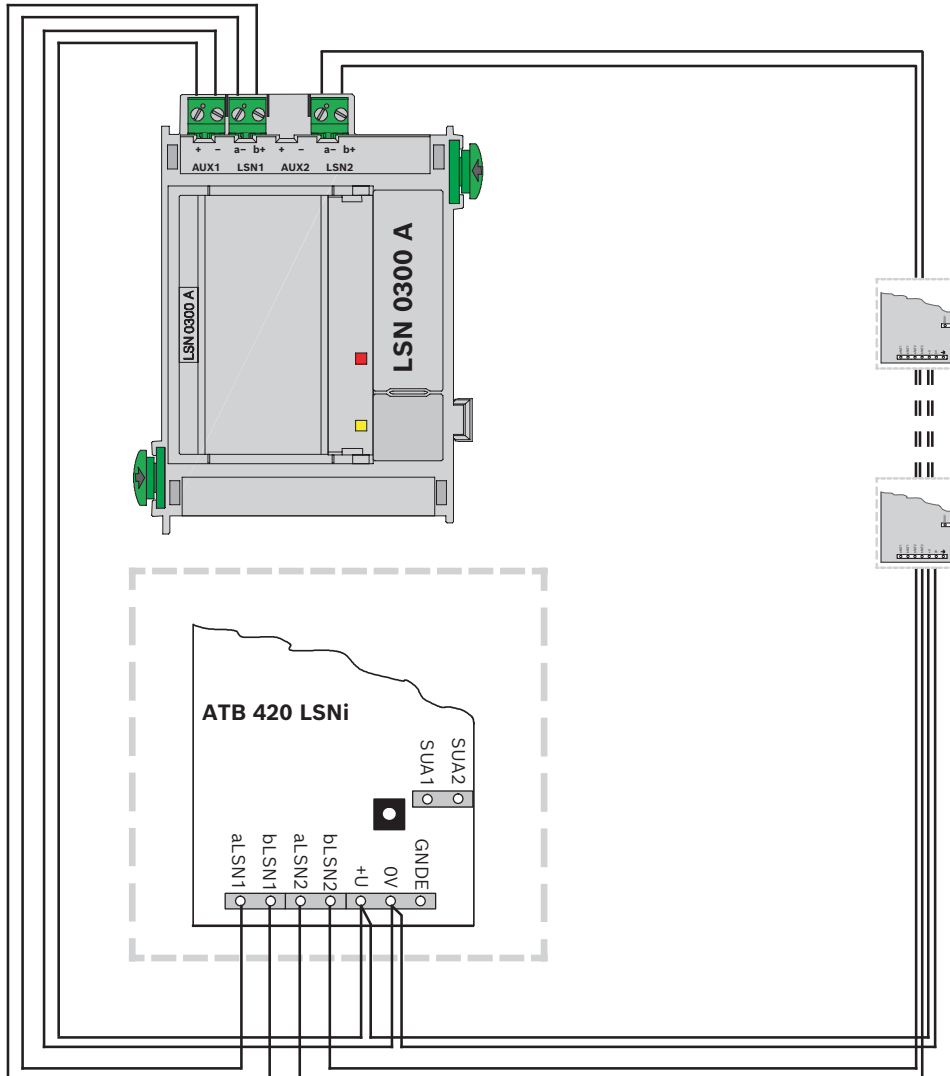
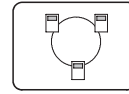



**BAT 100 LSN**  
**ATG 420 LSNi**

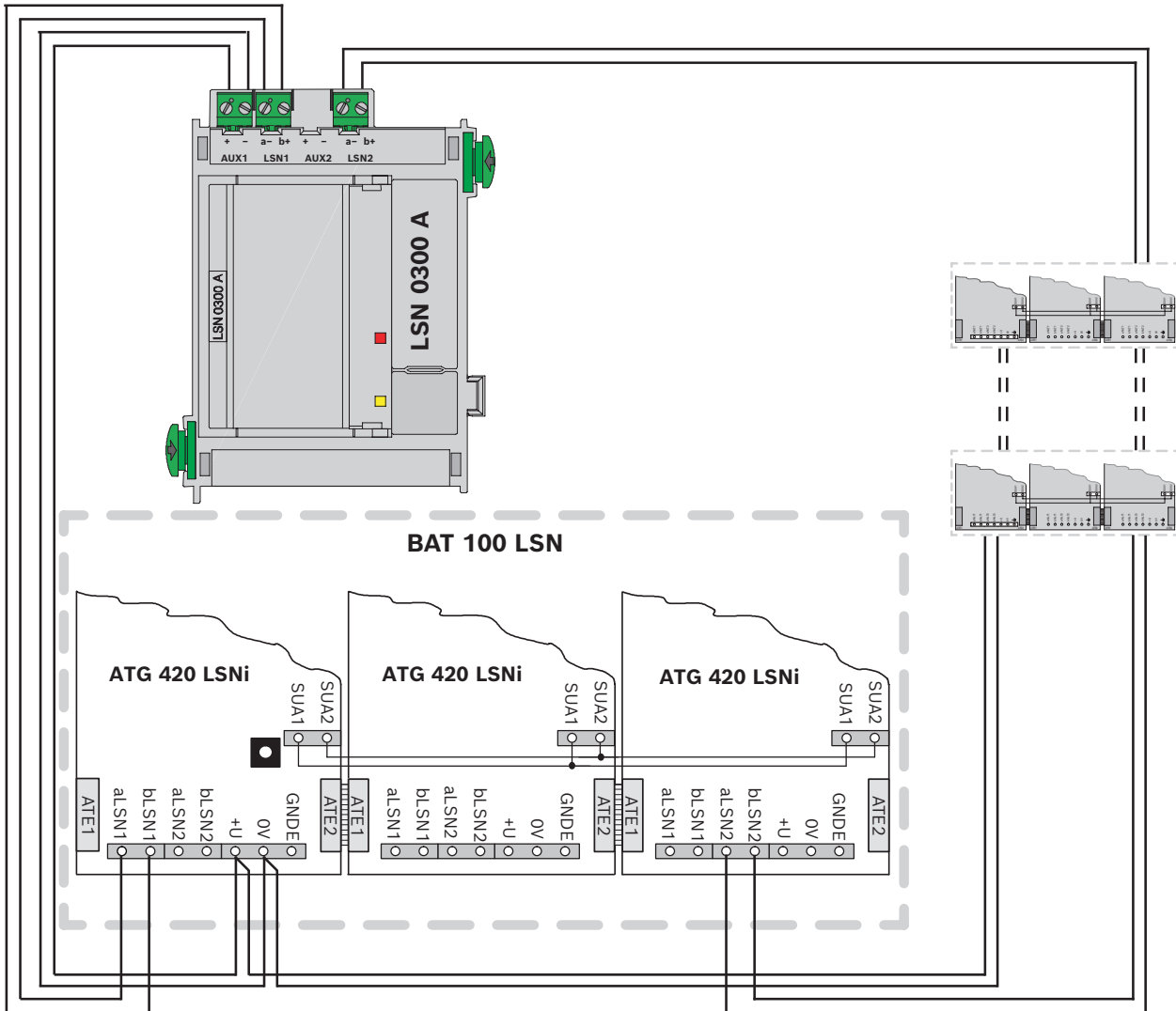
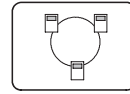

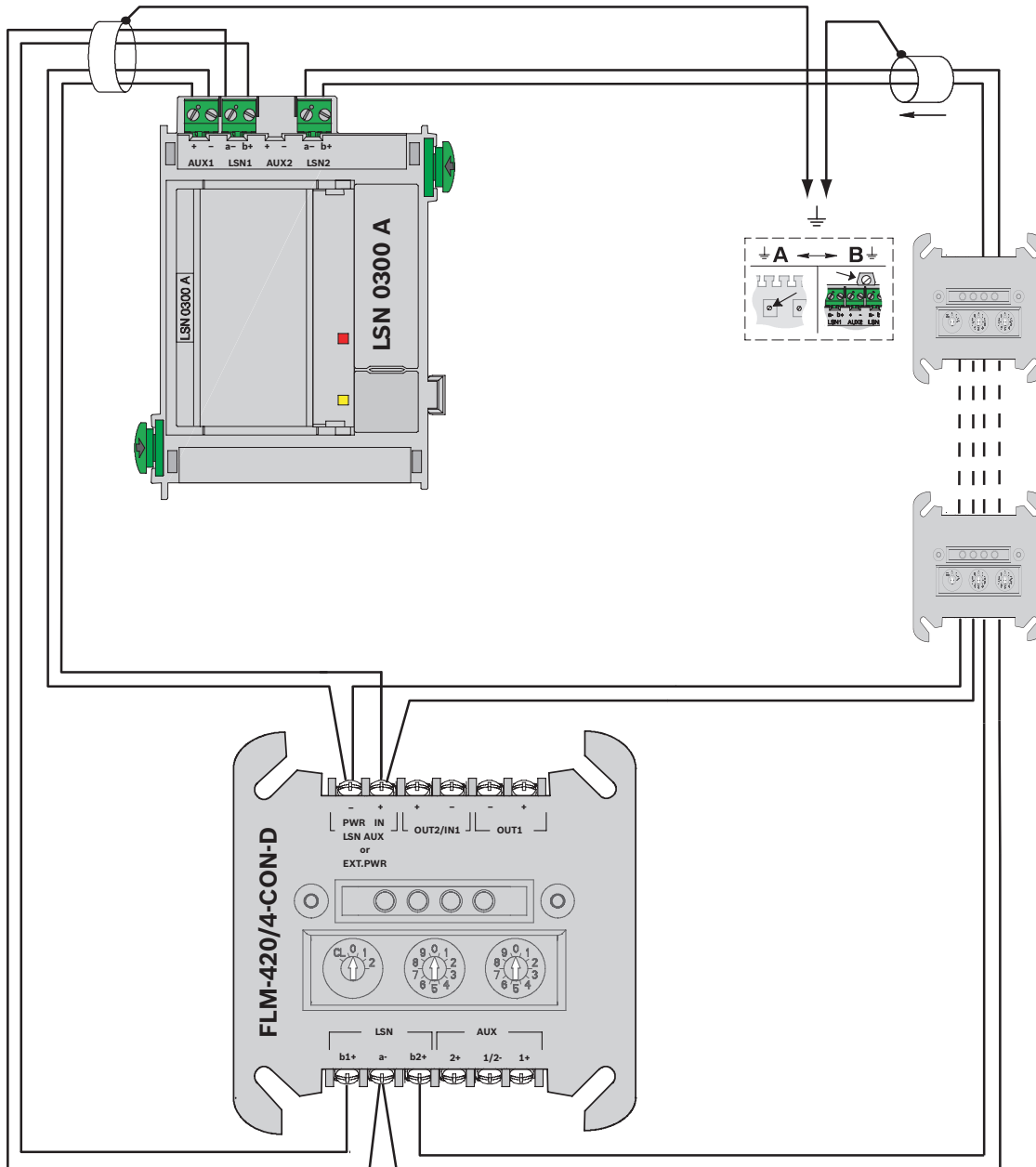
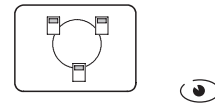
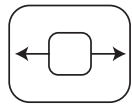



**FBF 100 LSN**

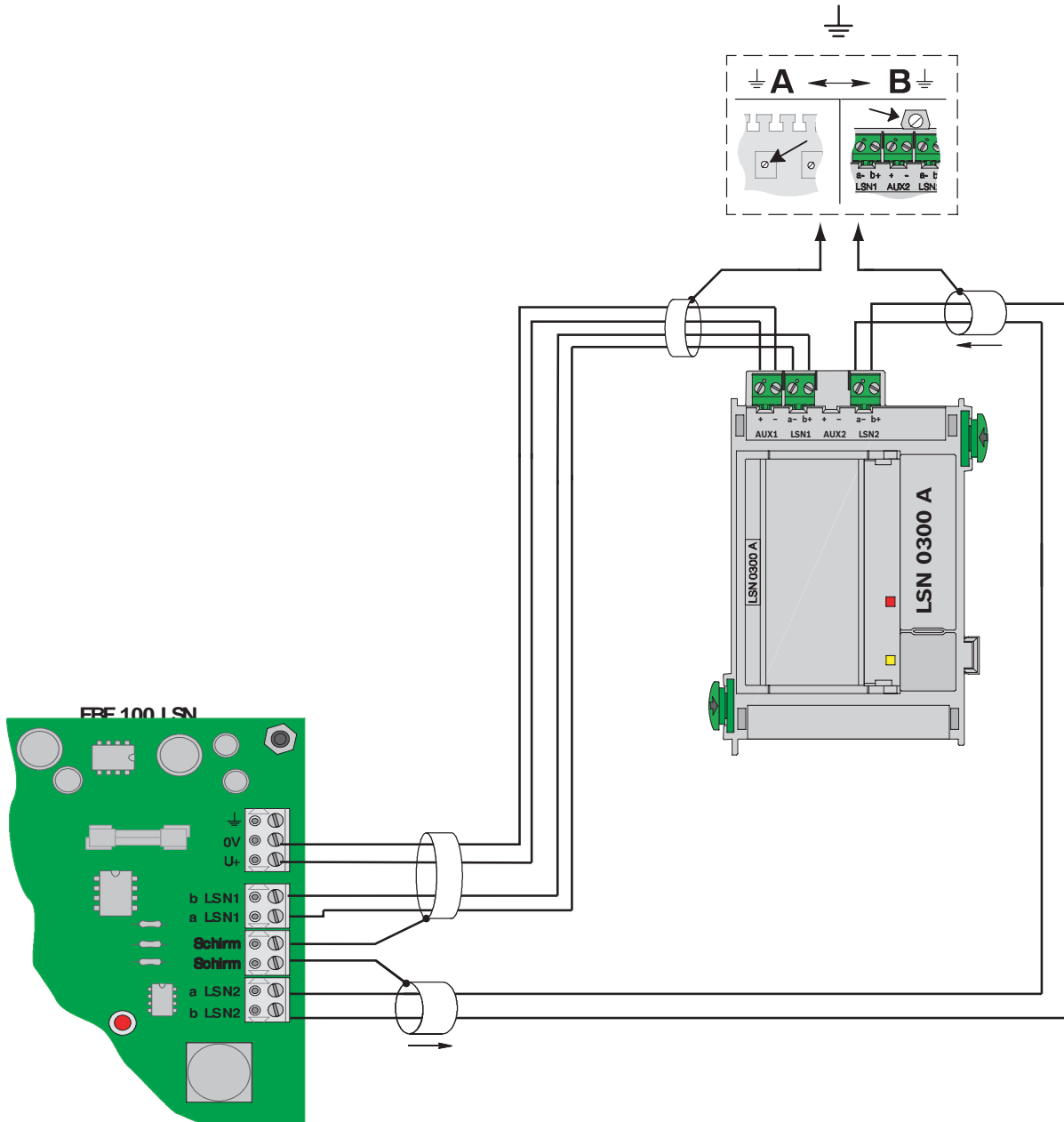
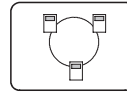



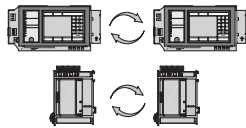

FLM-420-RLE-S

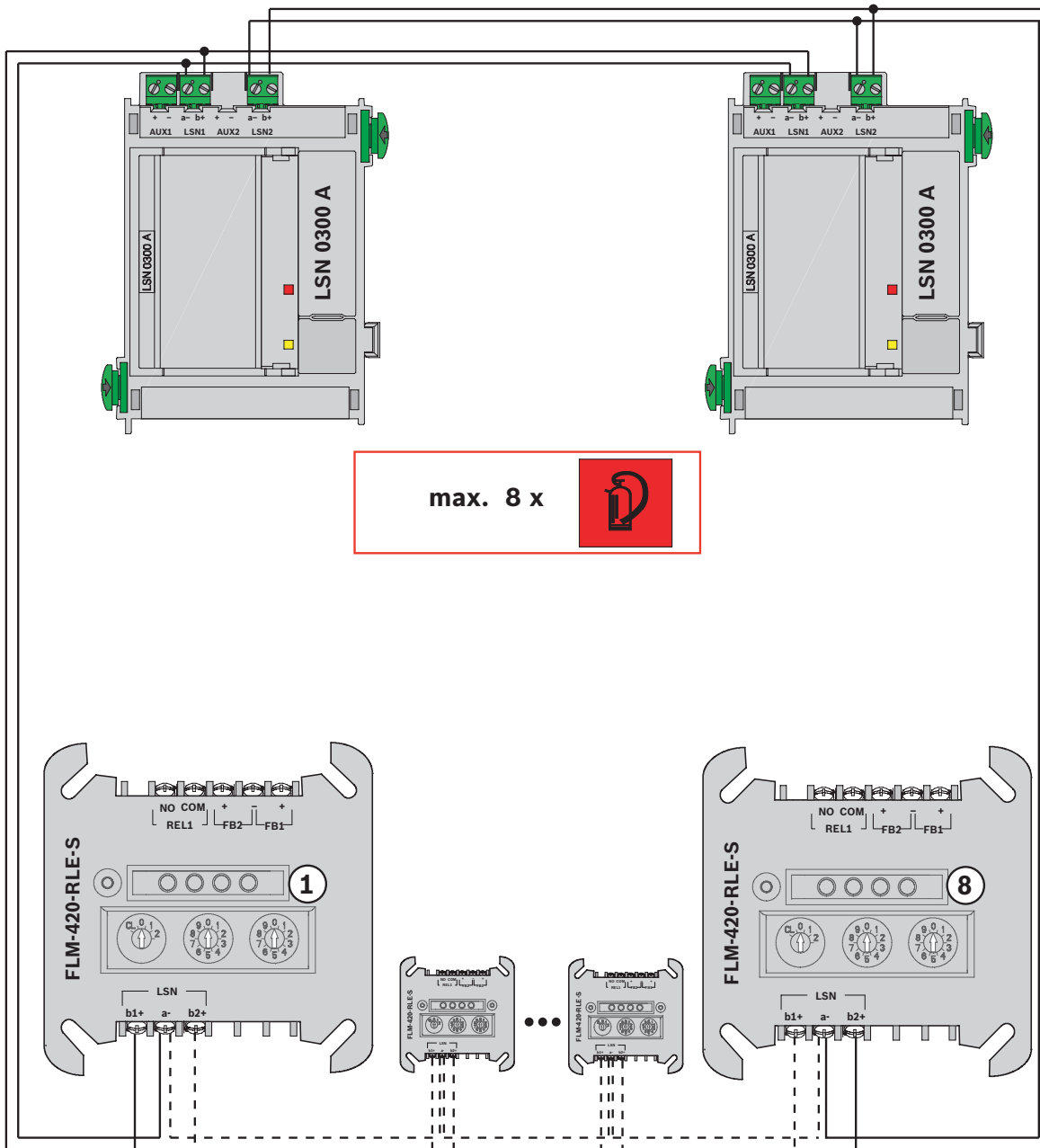
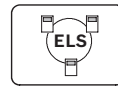



**FNX-425U-WFWH**  
**FNX-425U-RFWH**  
**FNX-425U-WFRD**  
**FNX-425U-RFRD**

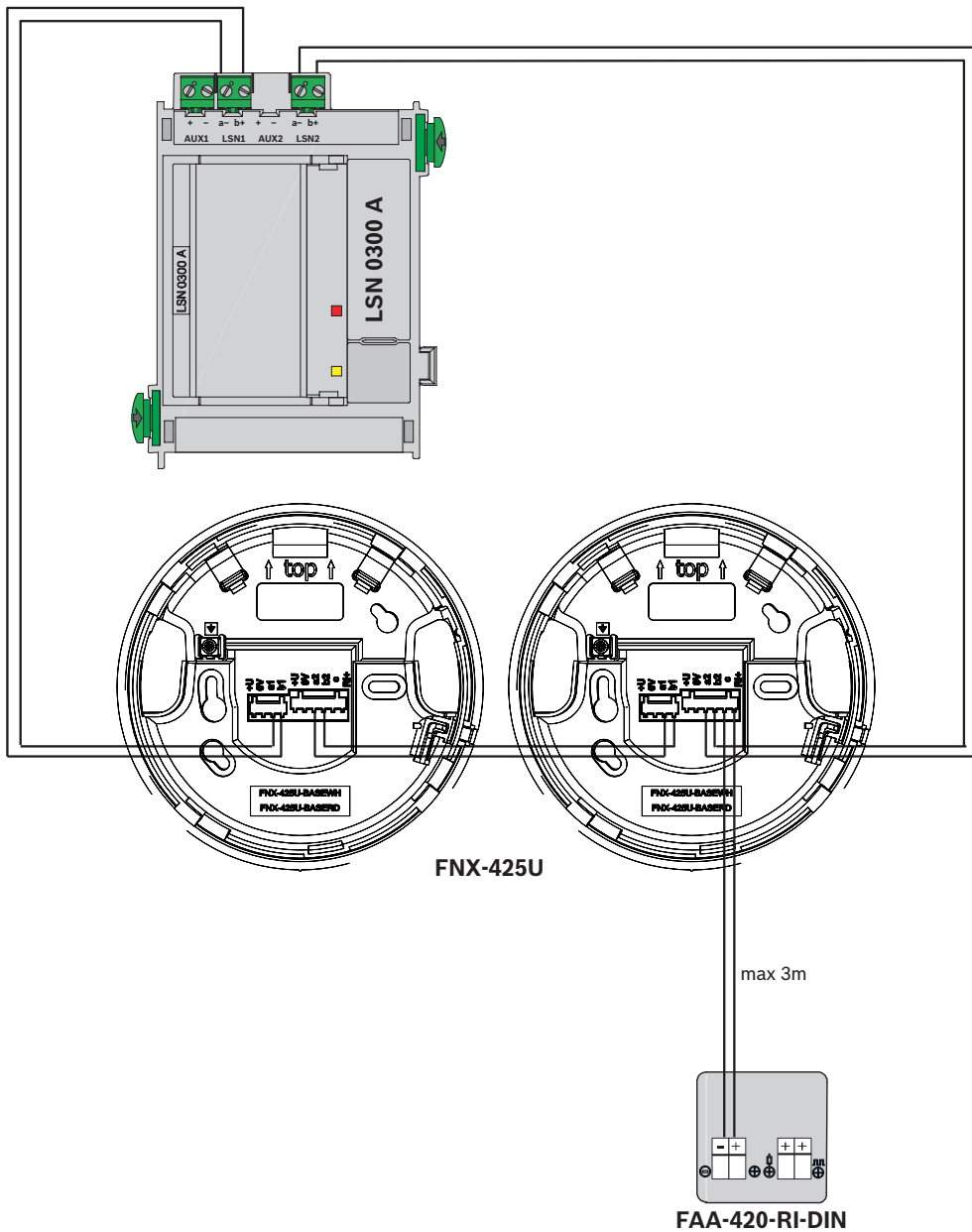
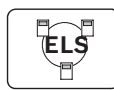



FNX-425U-WFWH  
 FNX-425U-RFWH  
 FNX-425U-WFRD  
 FNX-425U-RFRD

+ FNX-425U-COVWH  
 FNX-425U-COVRD

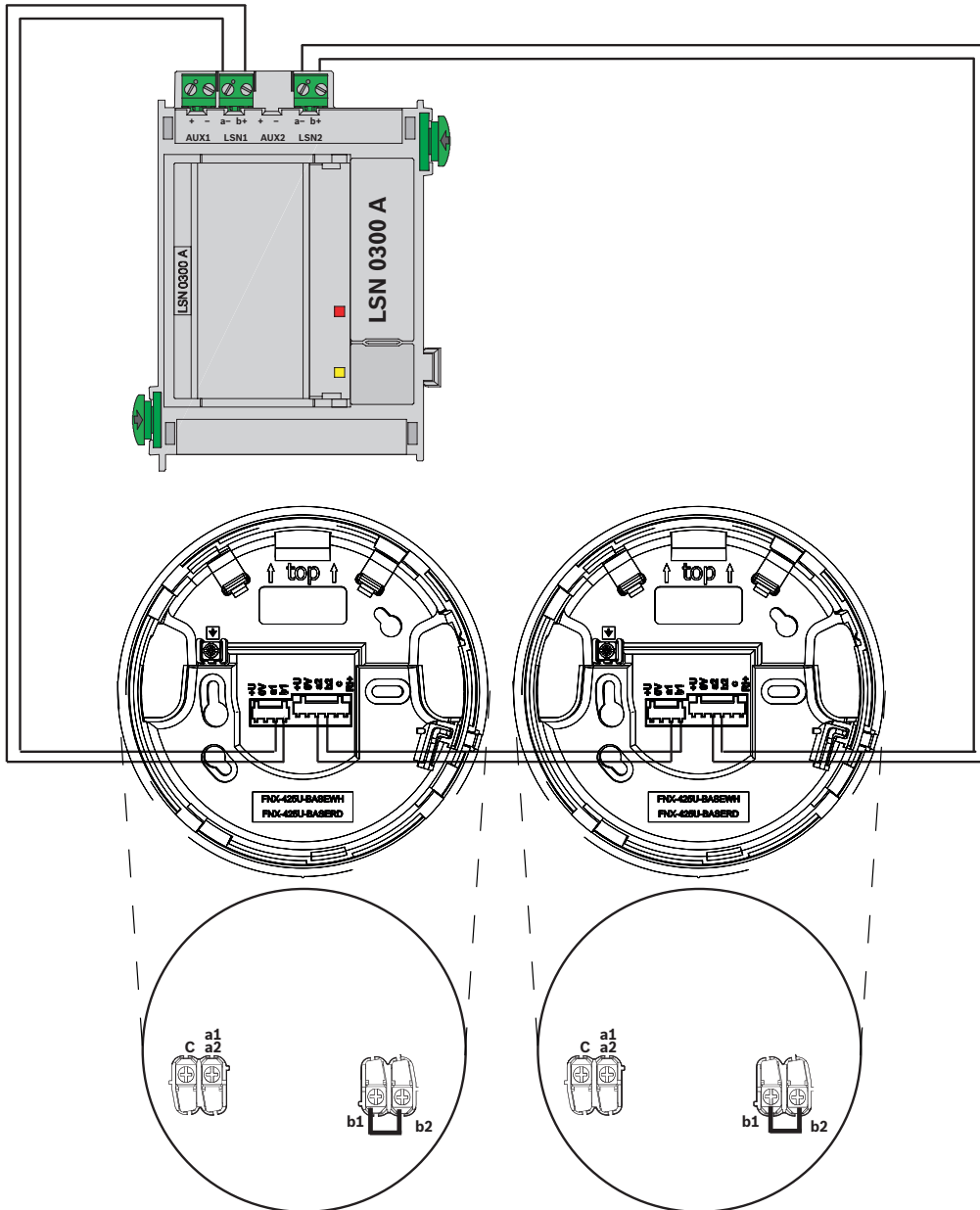
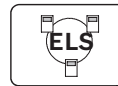

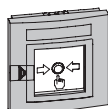
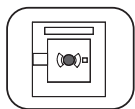

FMC-210...

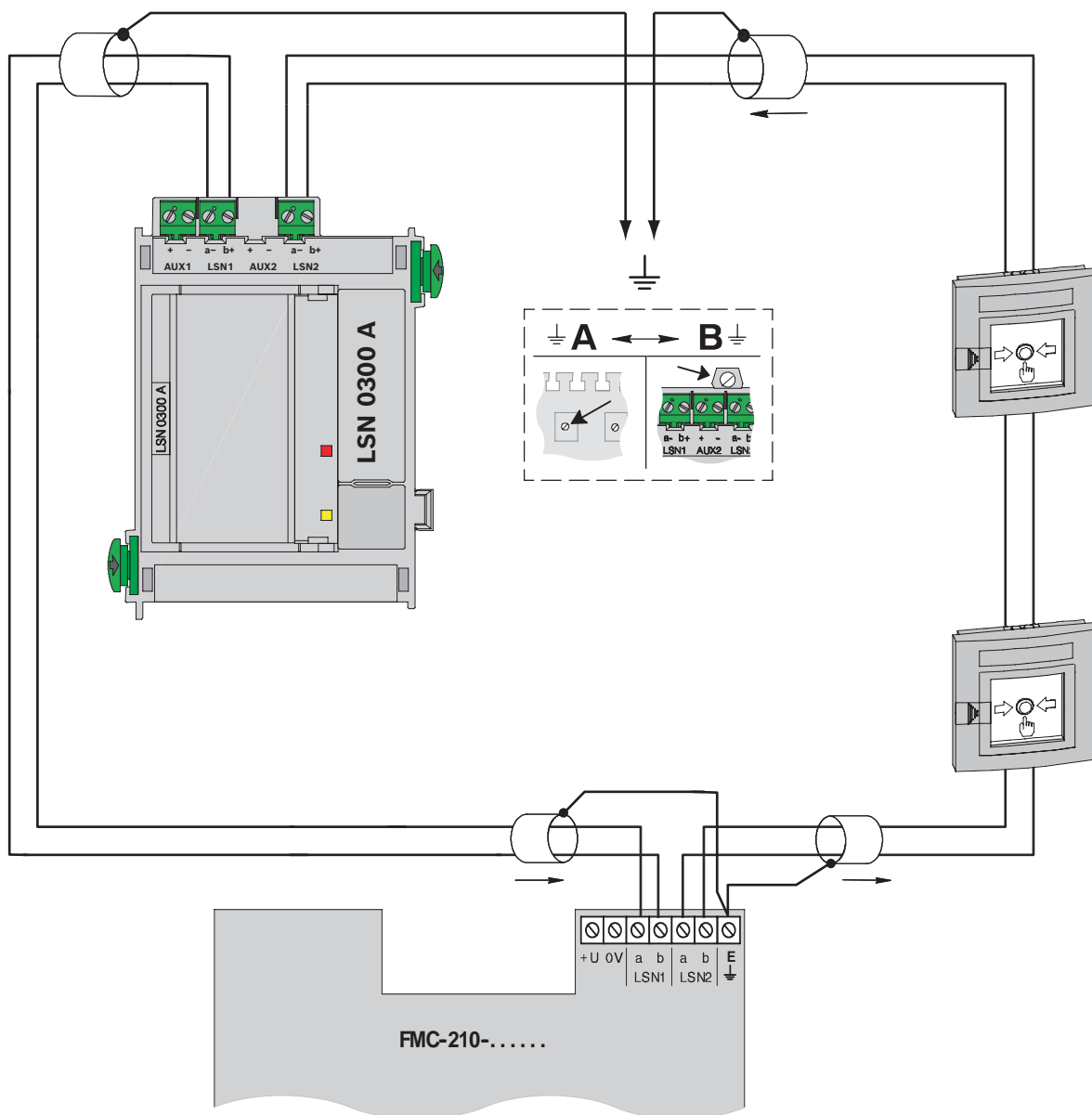
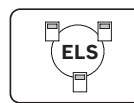

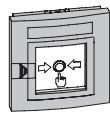
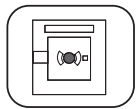

**FMC-210-IP66-R**

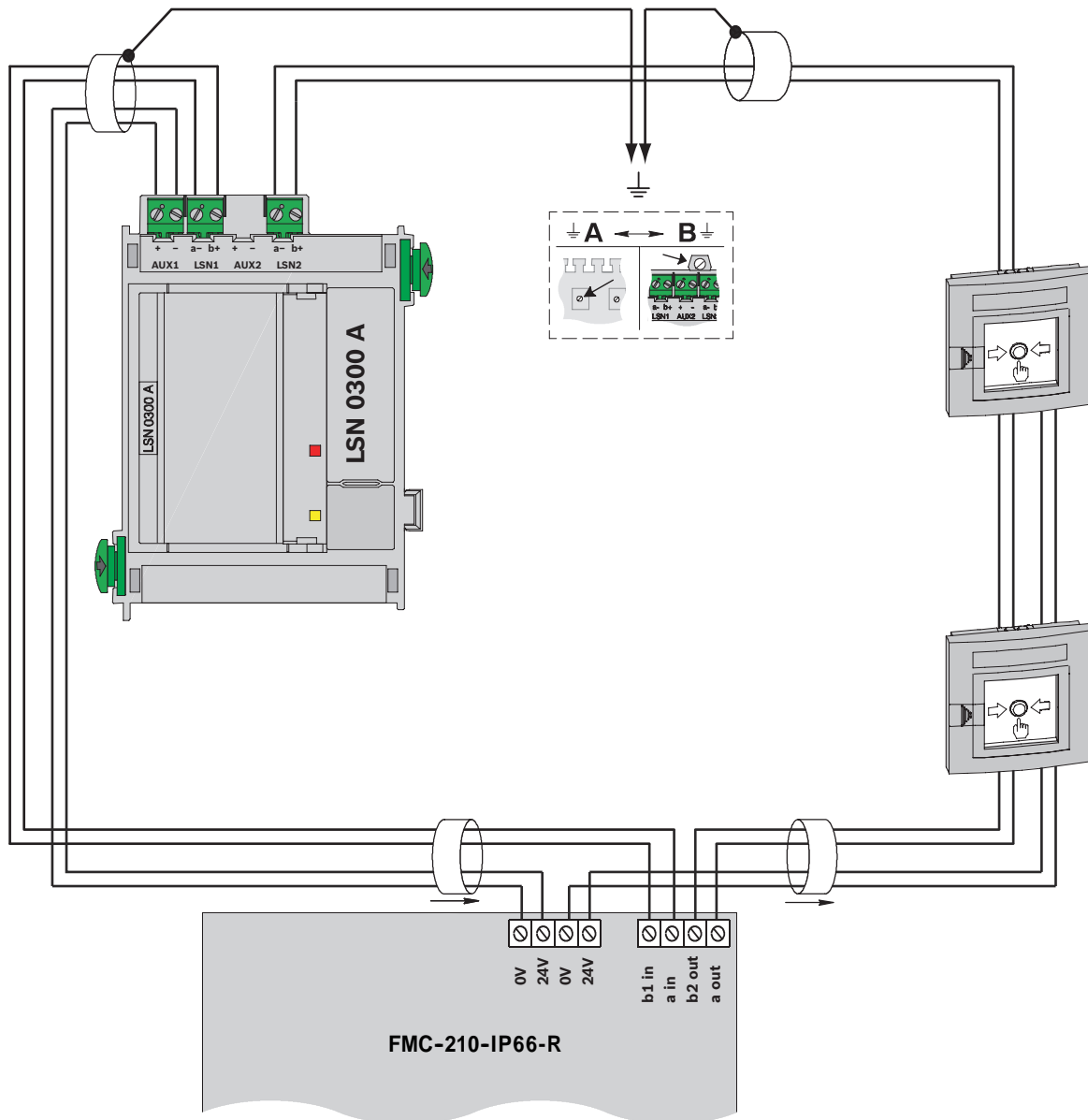
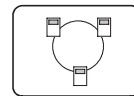

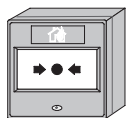
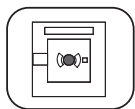

FMC-420RW-HSGRD  
 FMC-420RW-HSRRD  
 FMC-420RW-GFGRD  
 FMC-420RW-GFRRD  
 FMC-420RW-GSGRD  
 FMC-420RW-GSRRD

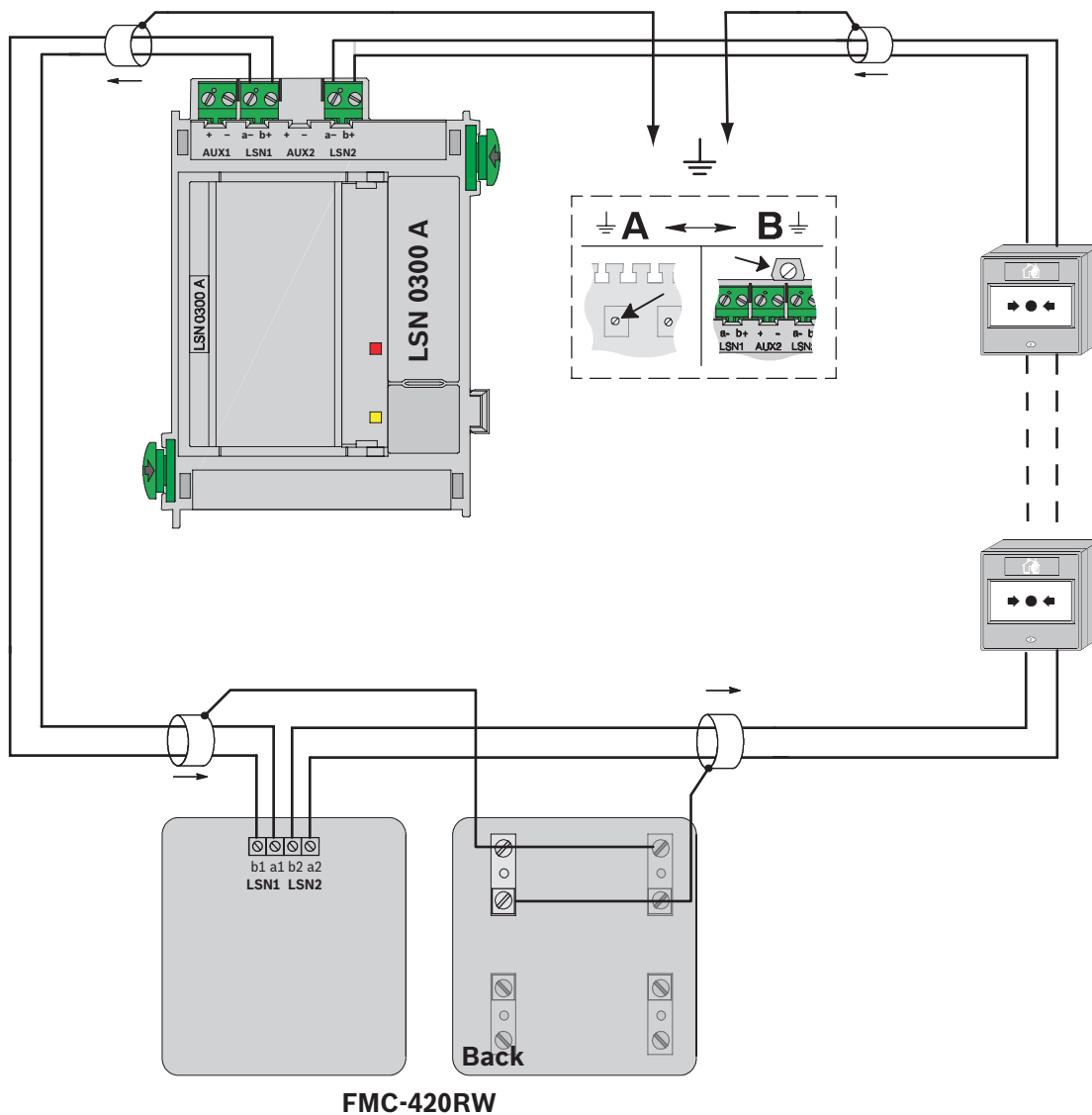
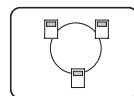

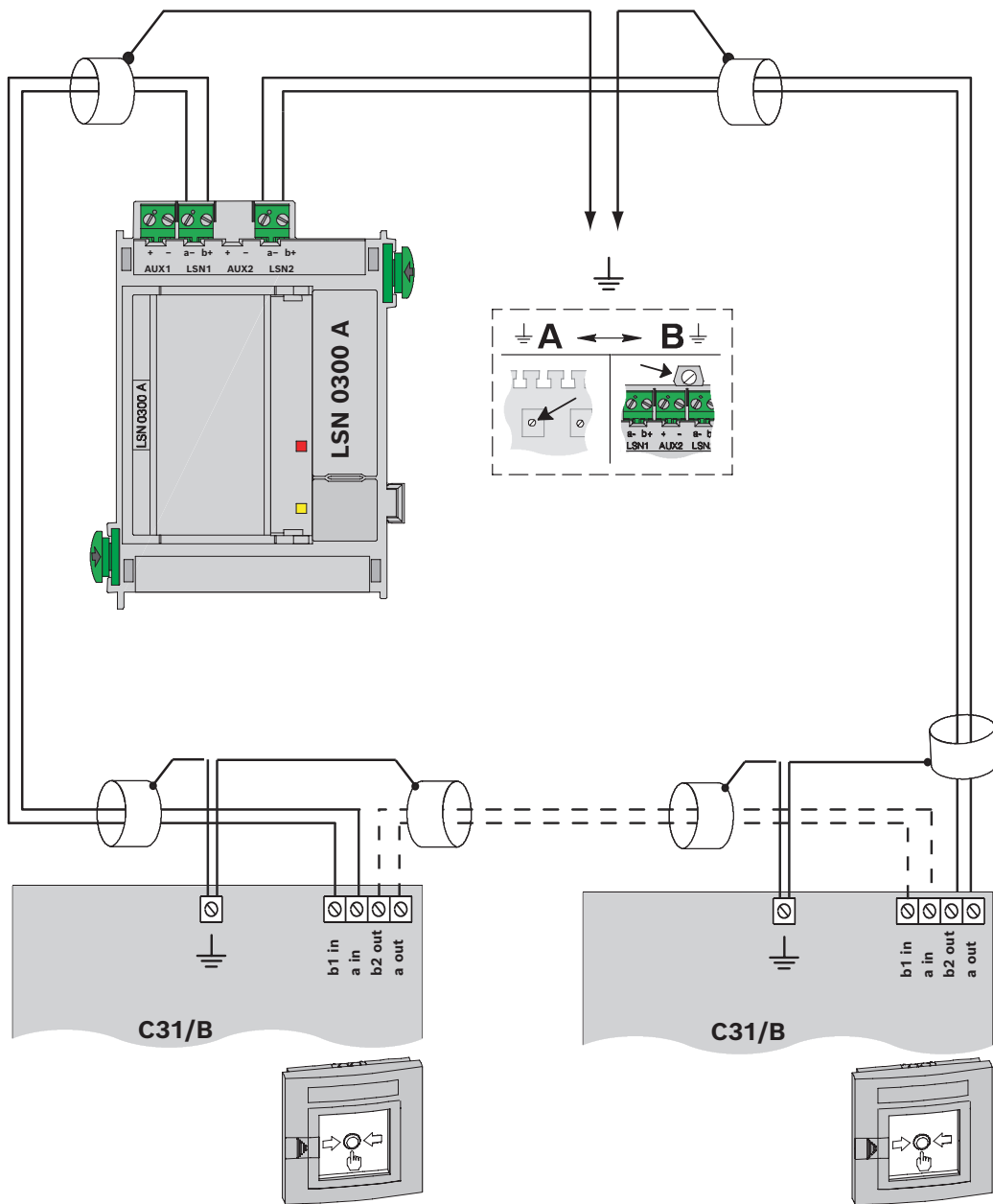
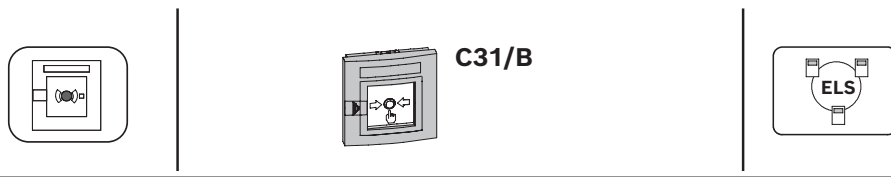

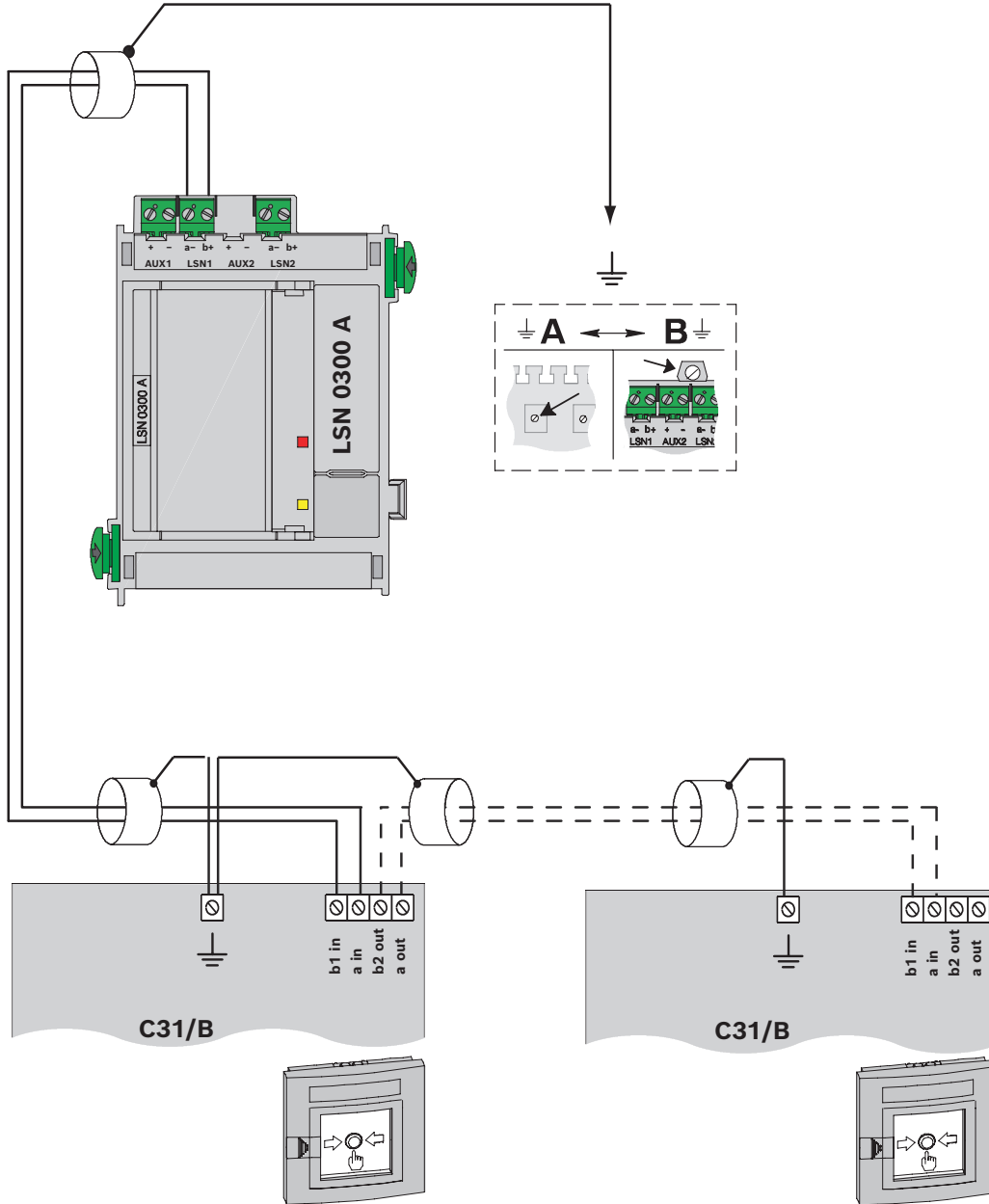
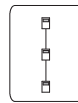
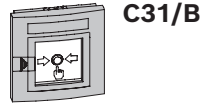
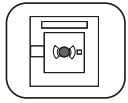



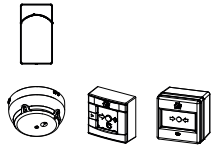

**FWI-270**

**FDOOT271-O**  
**FDM275-O**  
**FDM273-O**

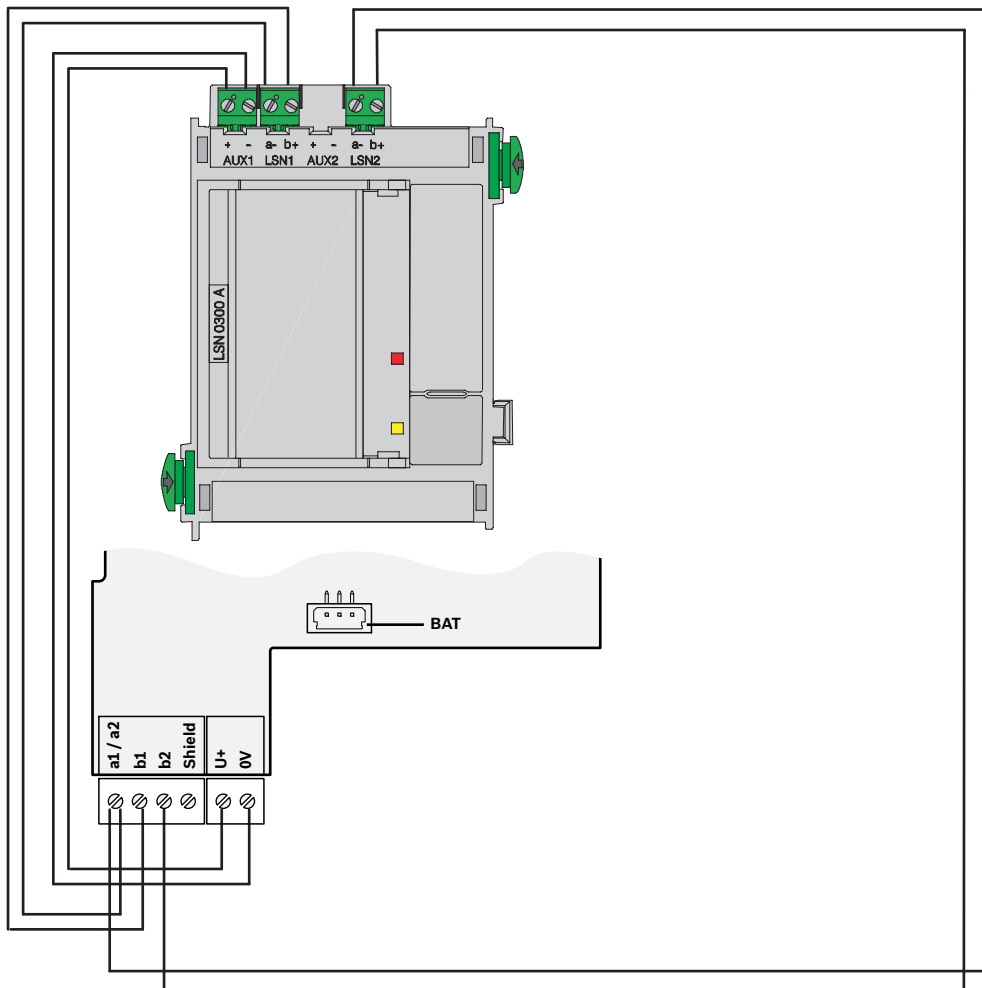
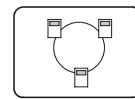

### 2.4.5 NZM 0002 A

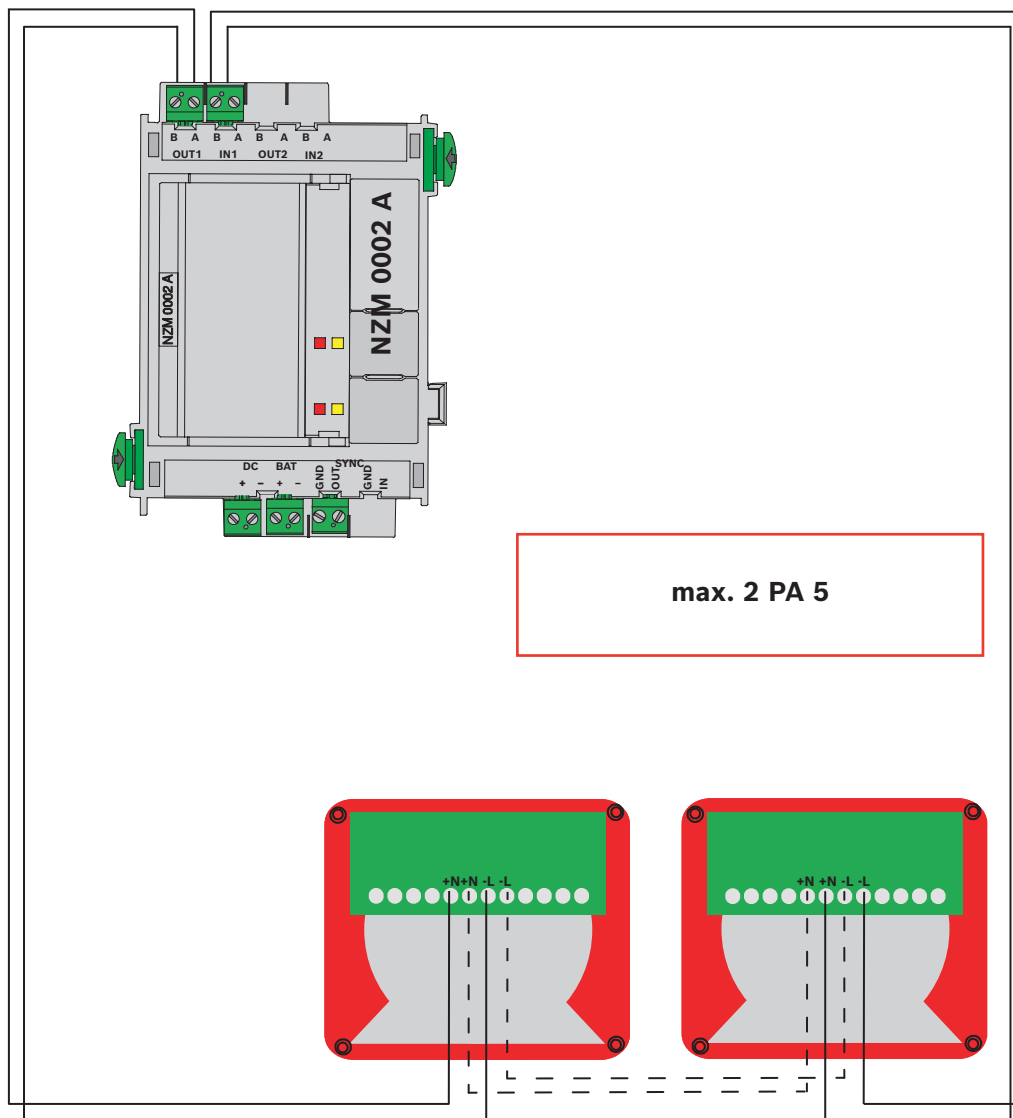
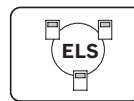

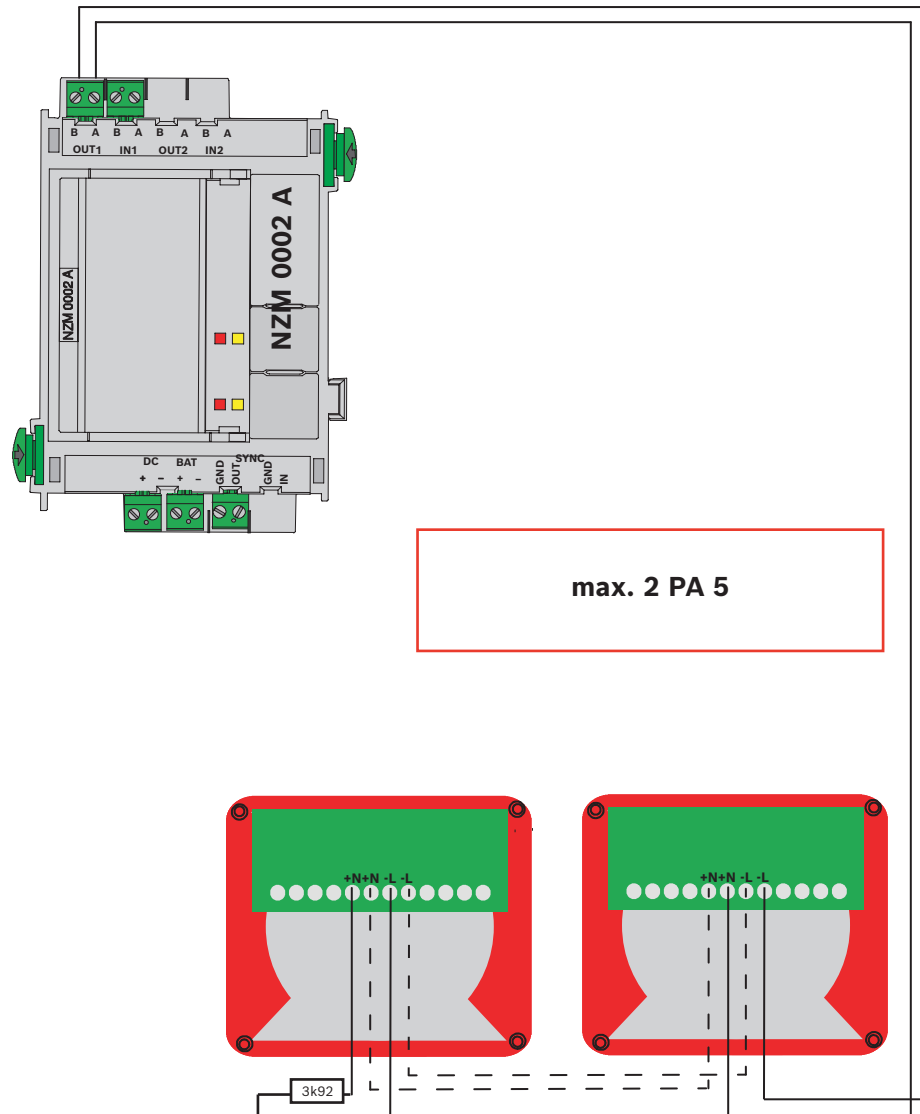
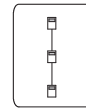

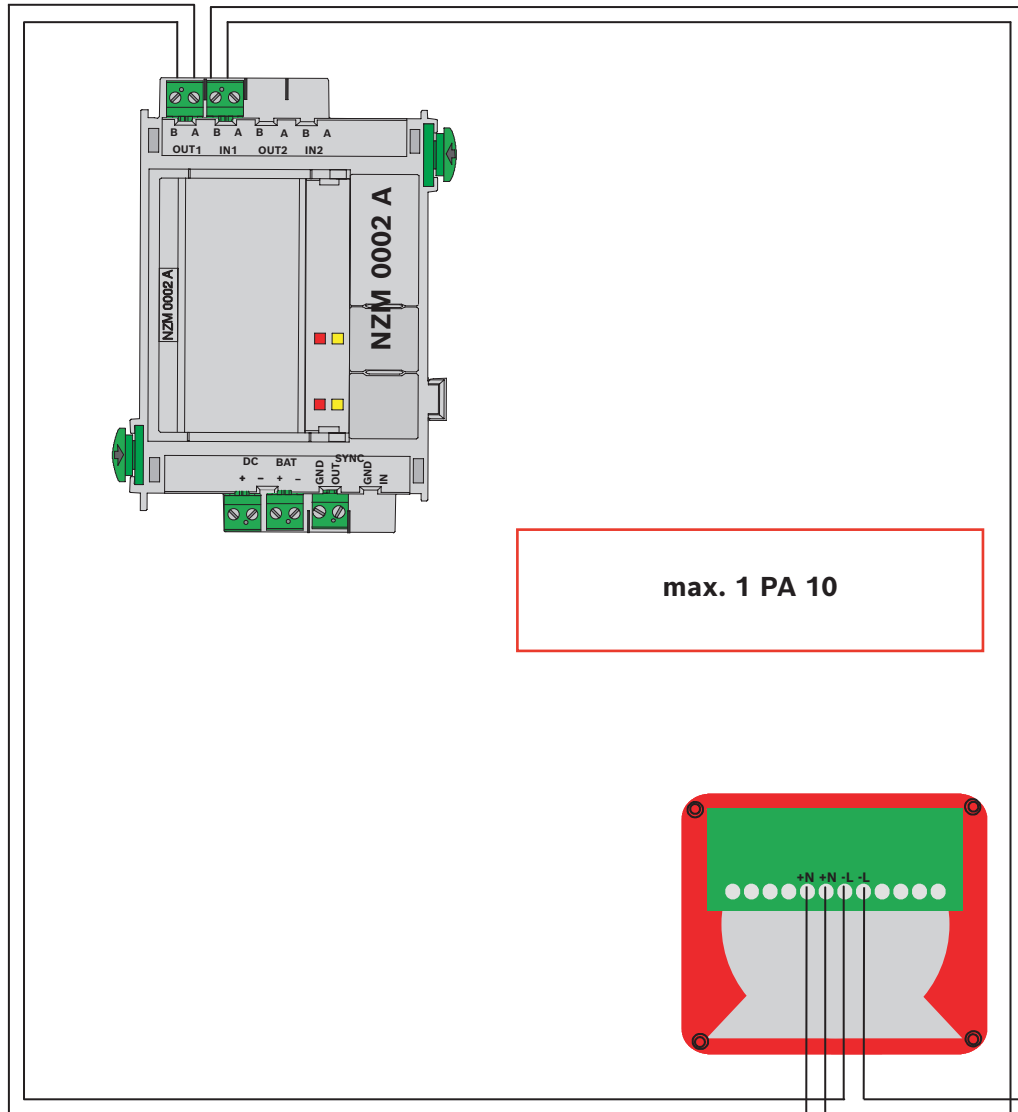
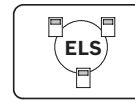
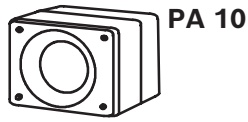

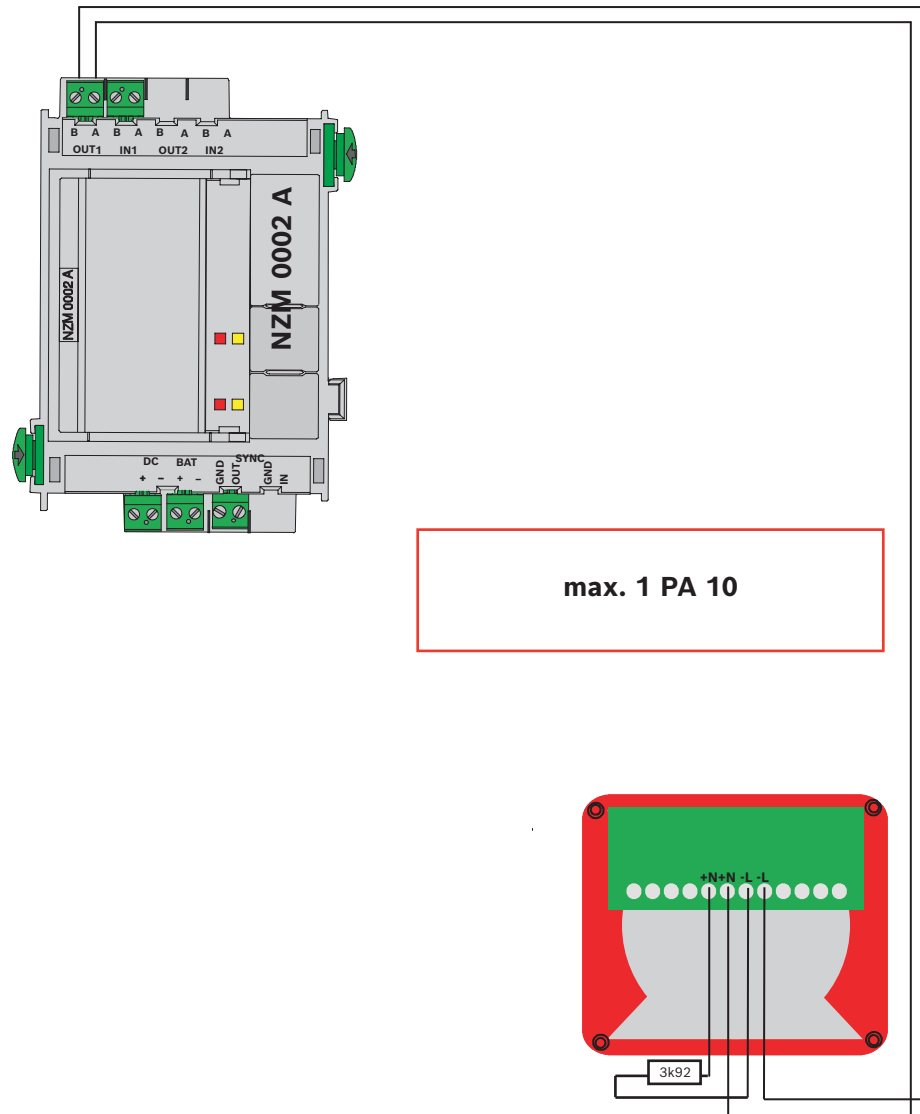
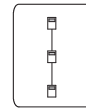

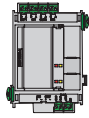
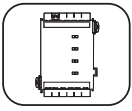

NZM 0002 A

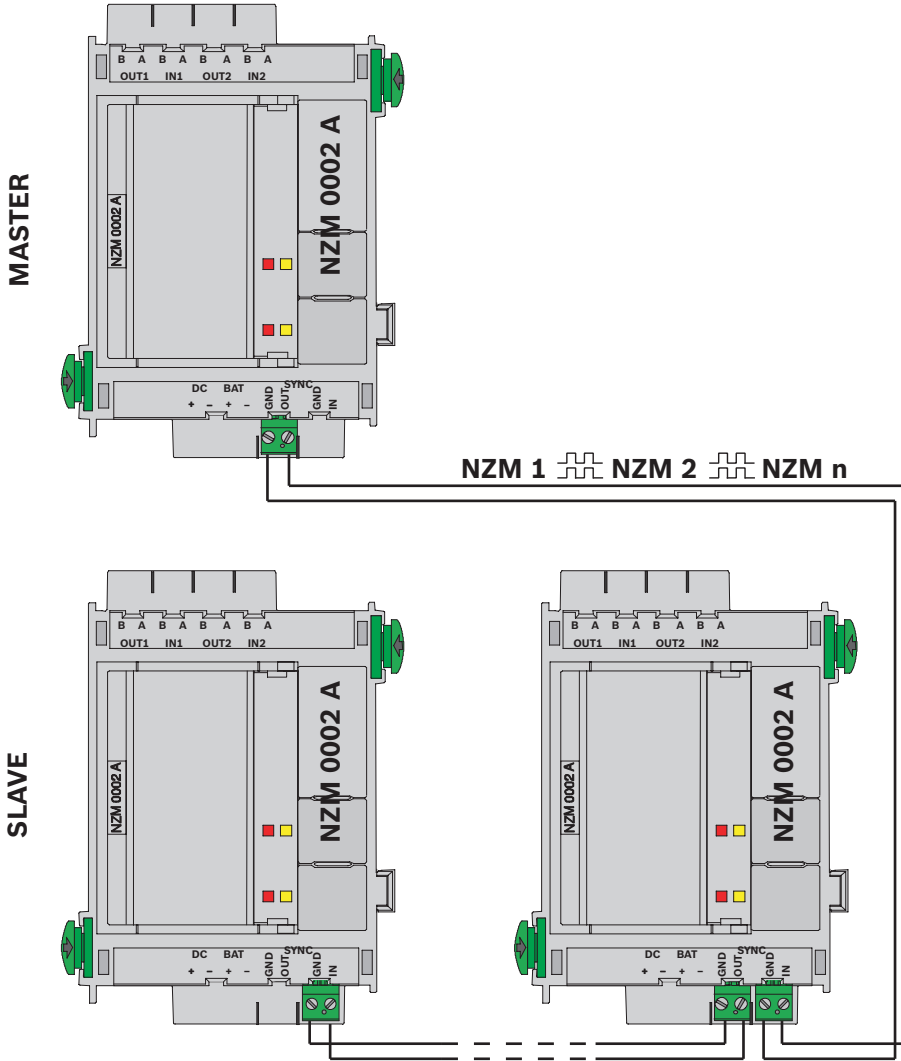

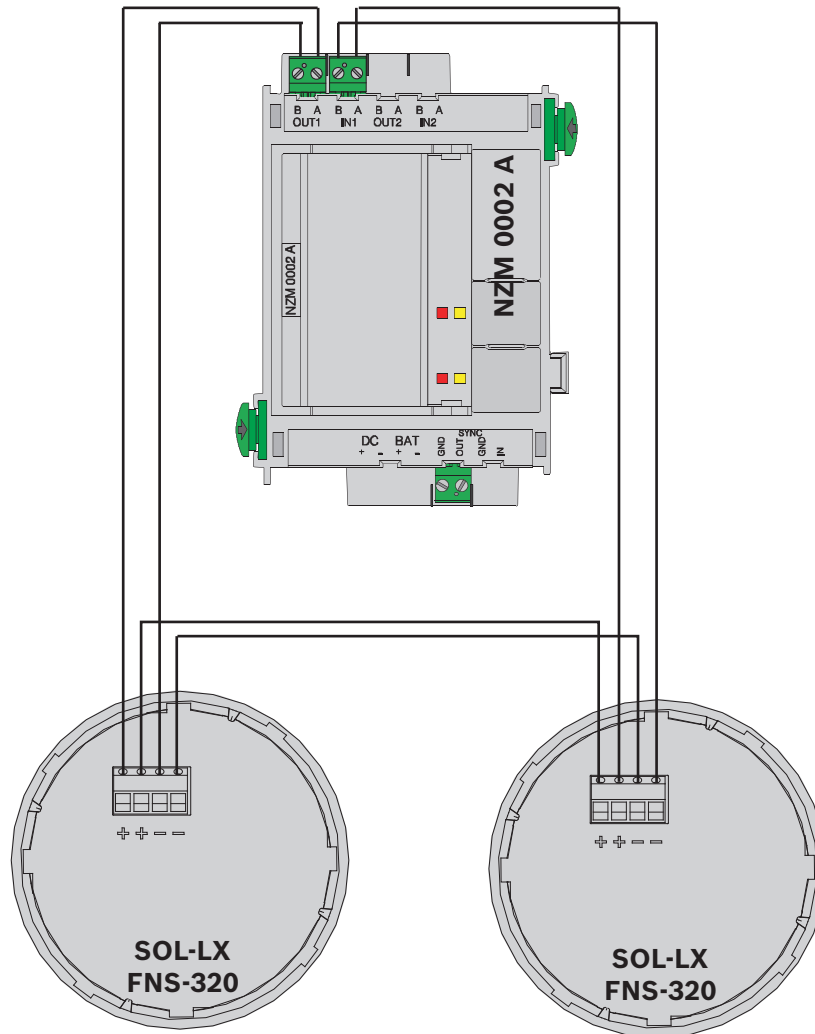
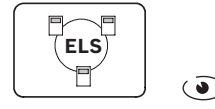

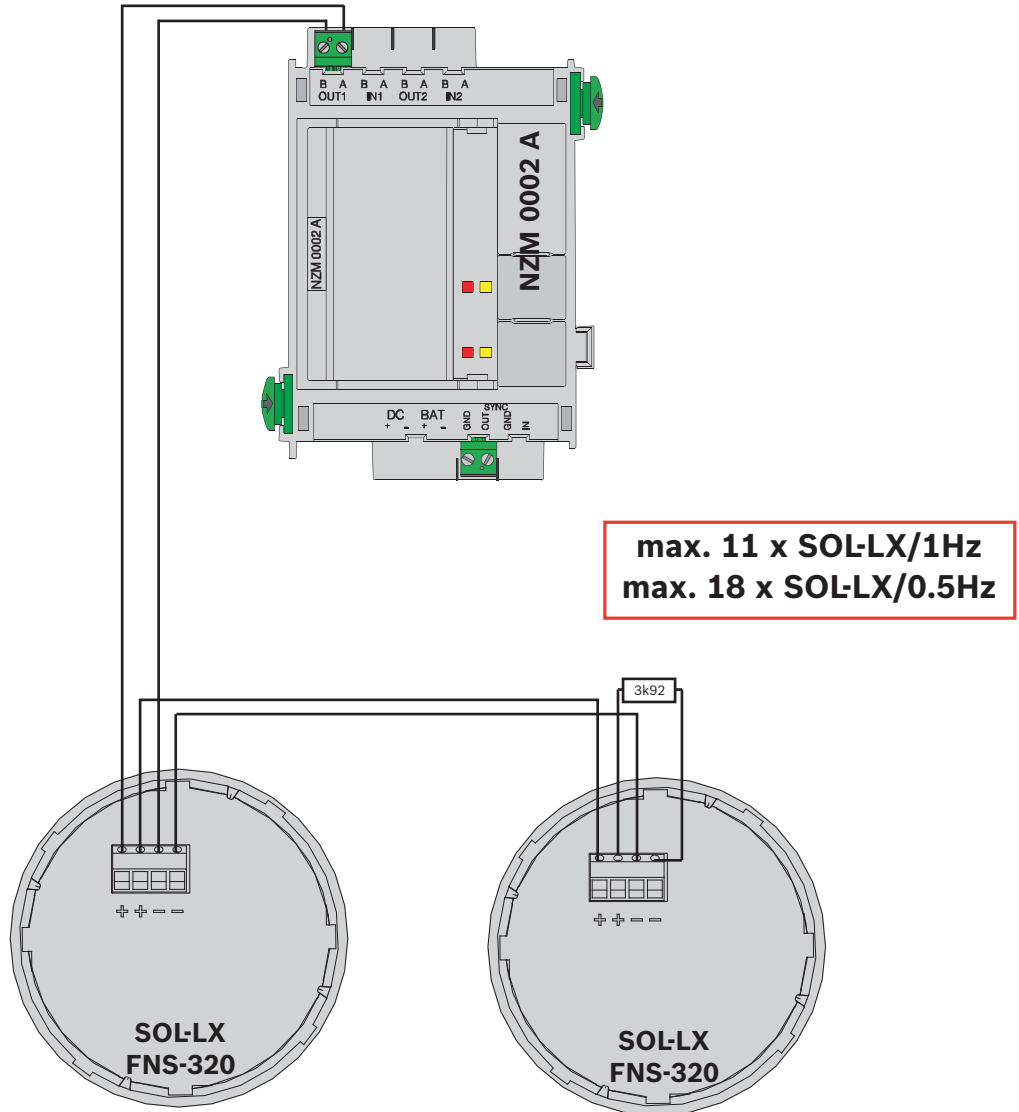
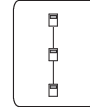



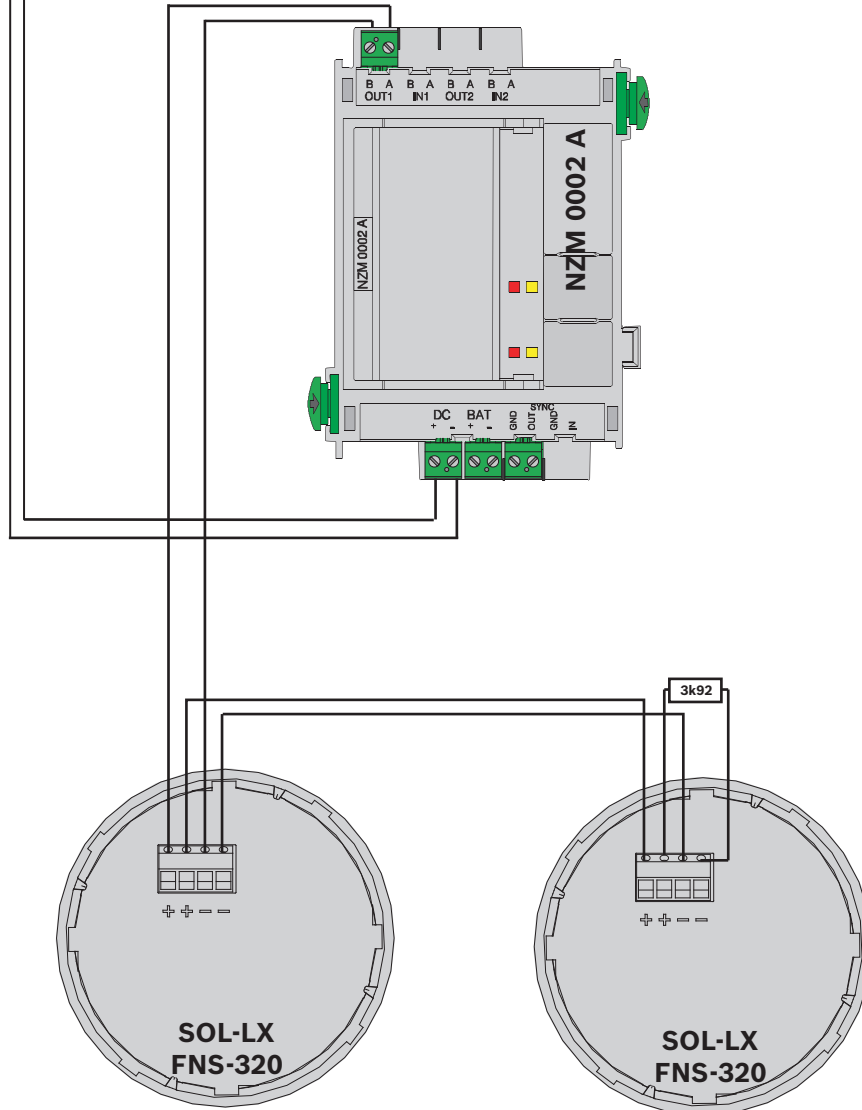
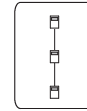

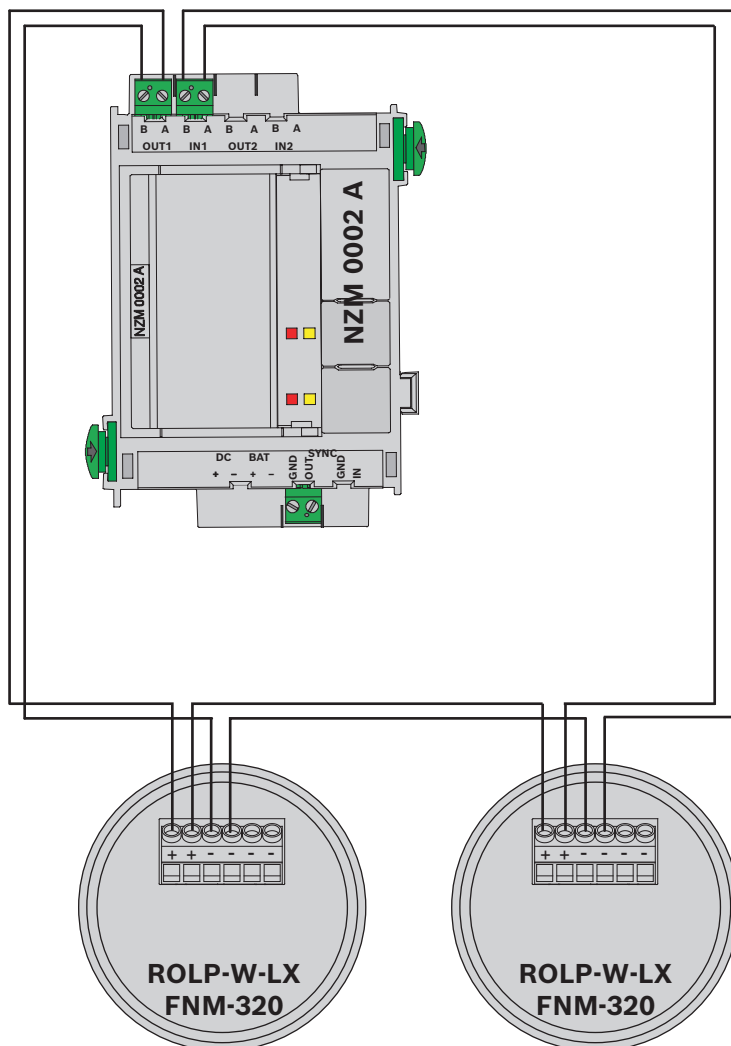
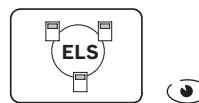

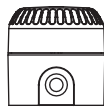

**ROLP-W-LX  
FNM-320**

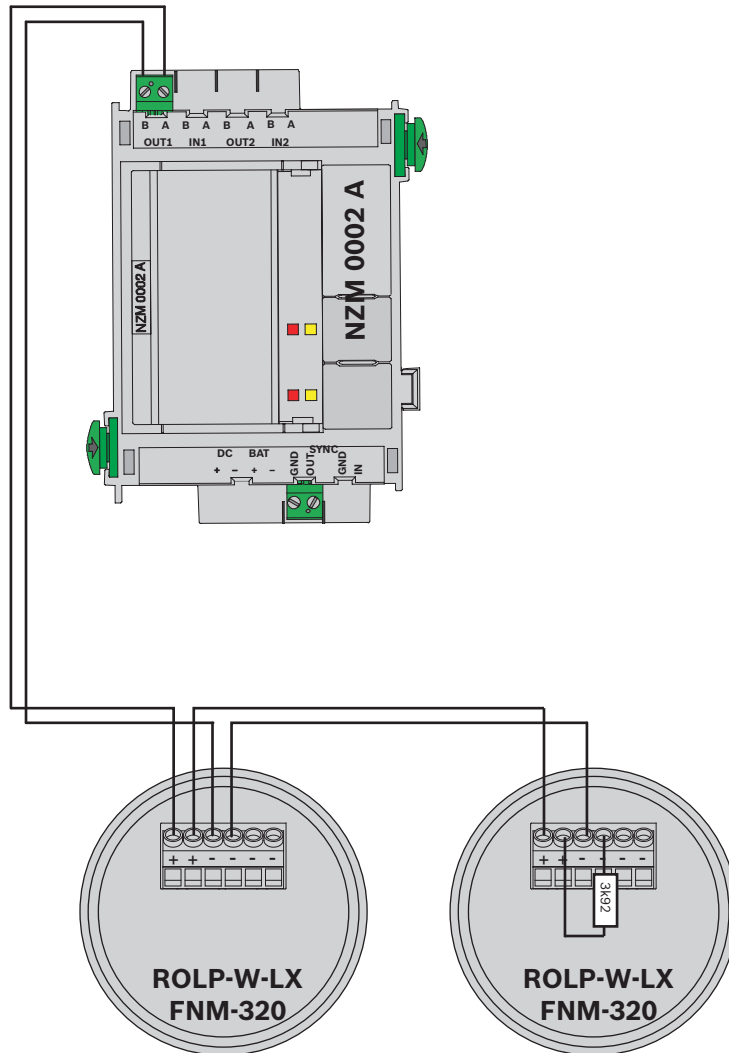
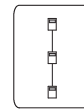



PB 2005

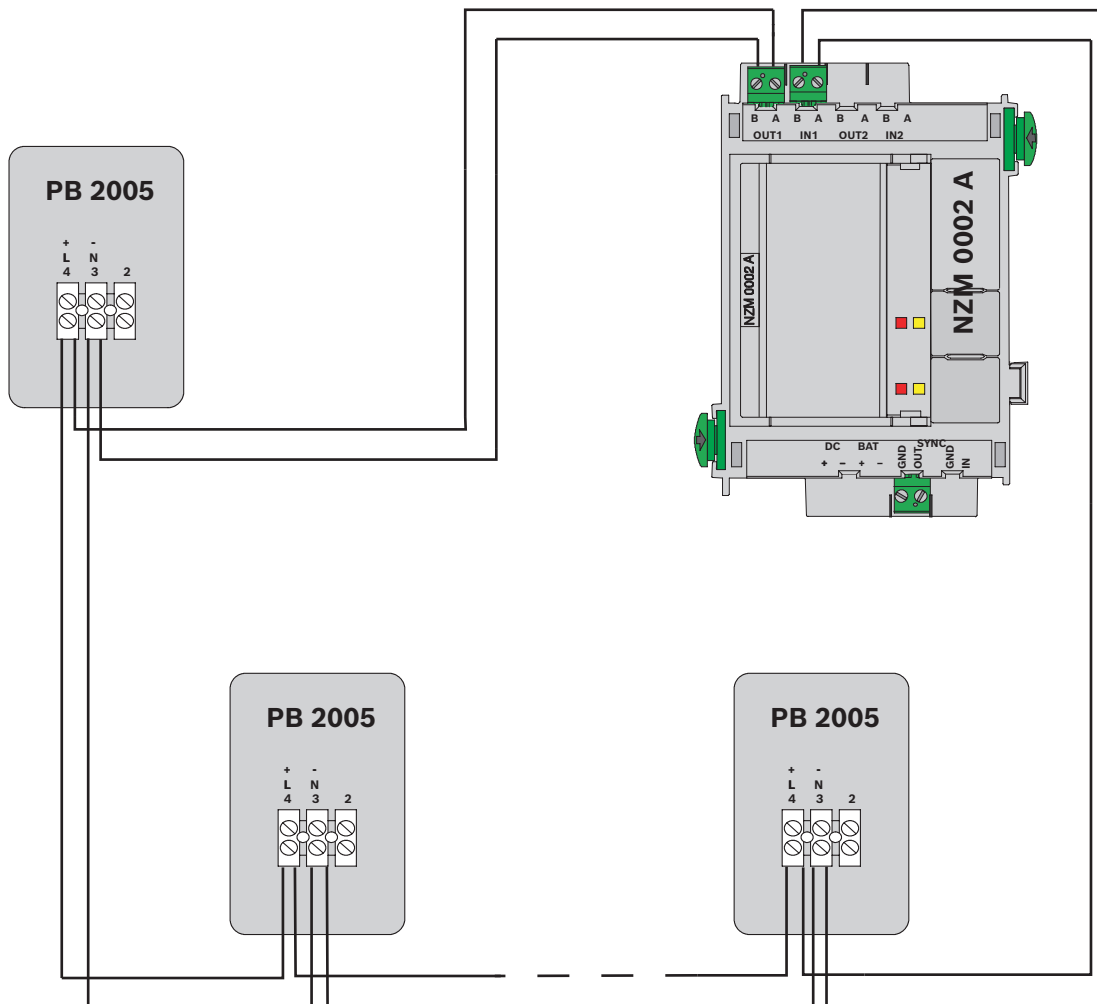
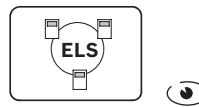



**PB 2005**

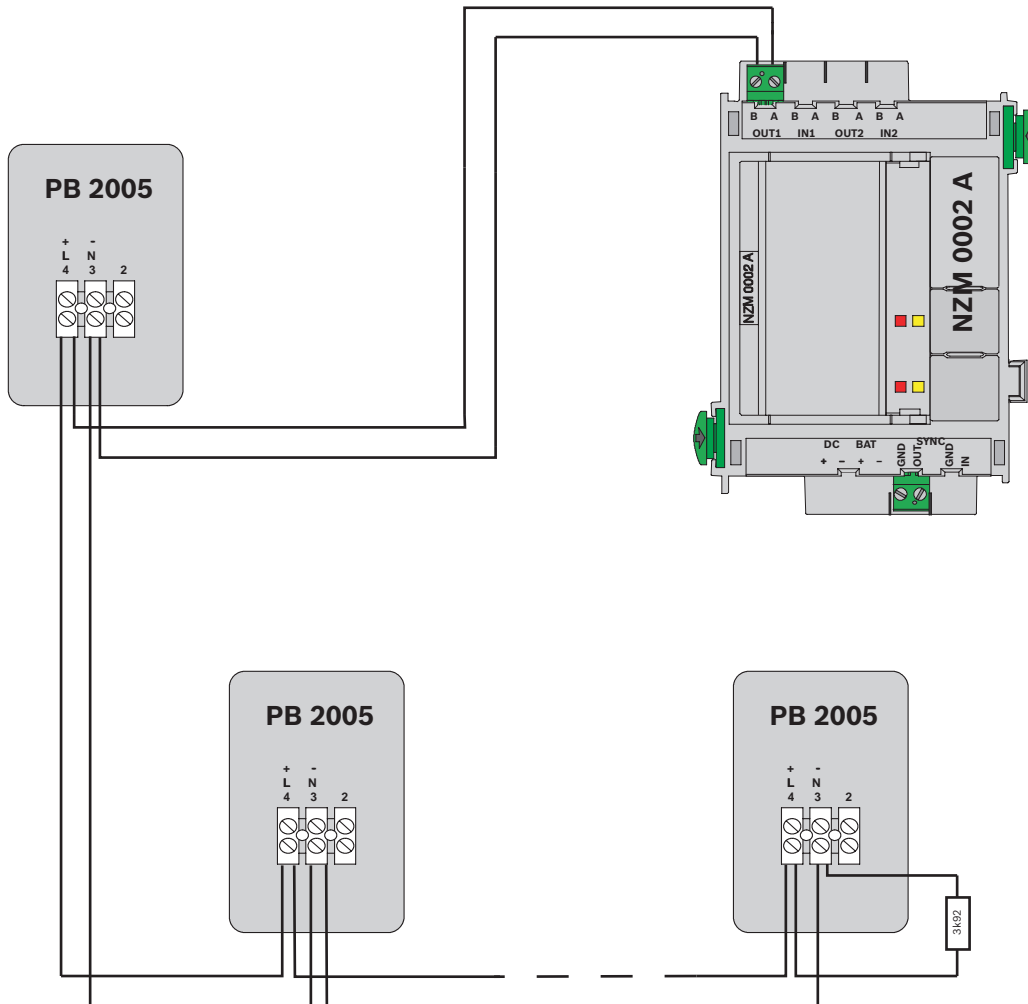
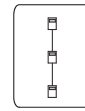



PB 2005

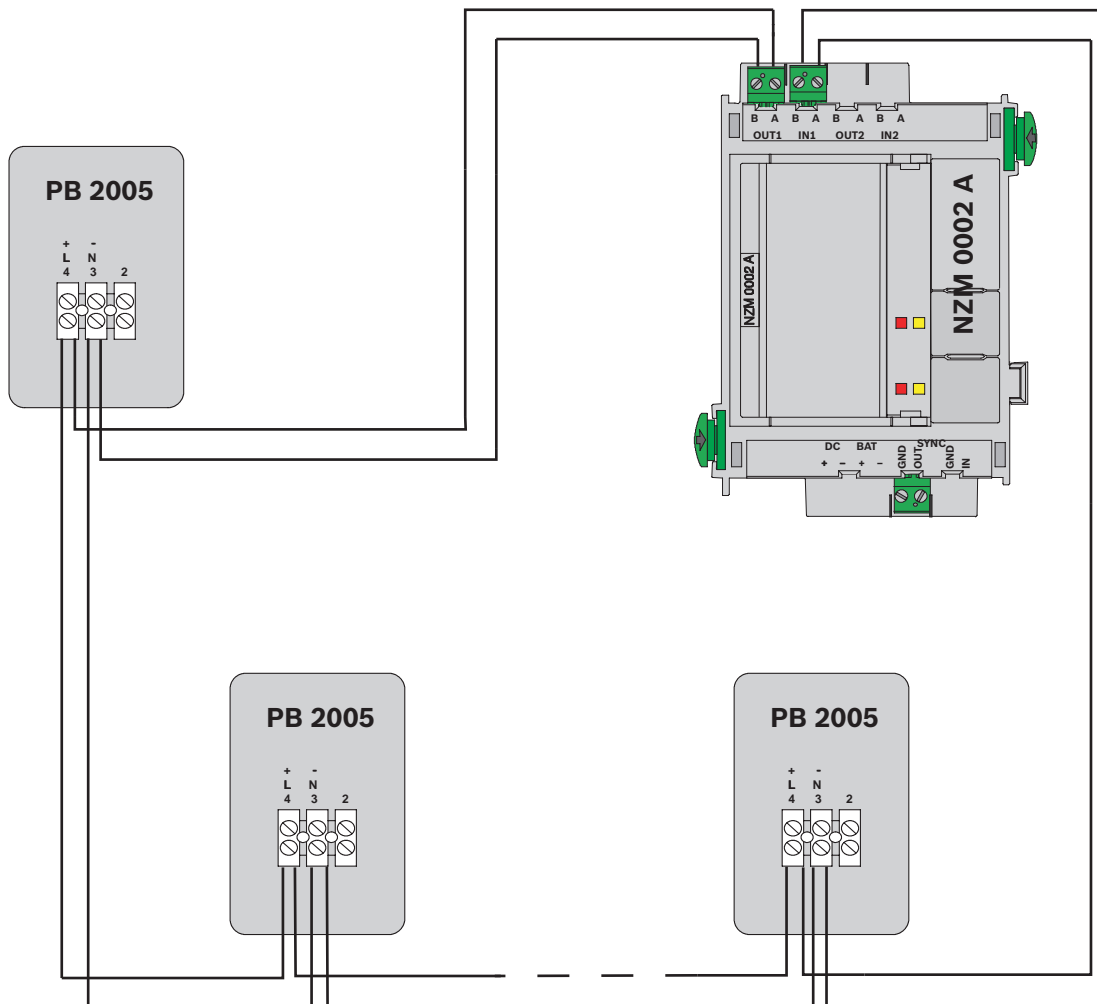
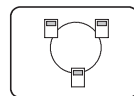

2.4.6

RMH 0002 A

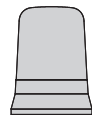

FNS-P400RTH

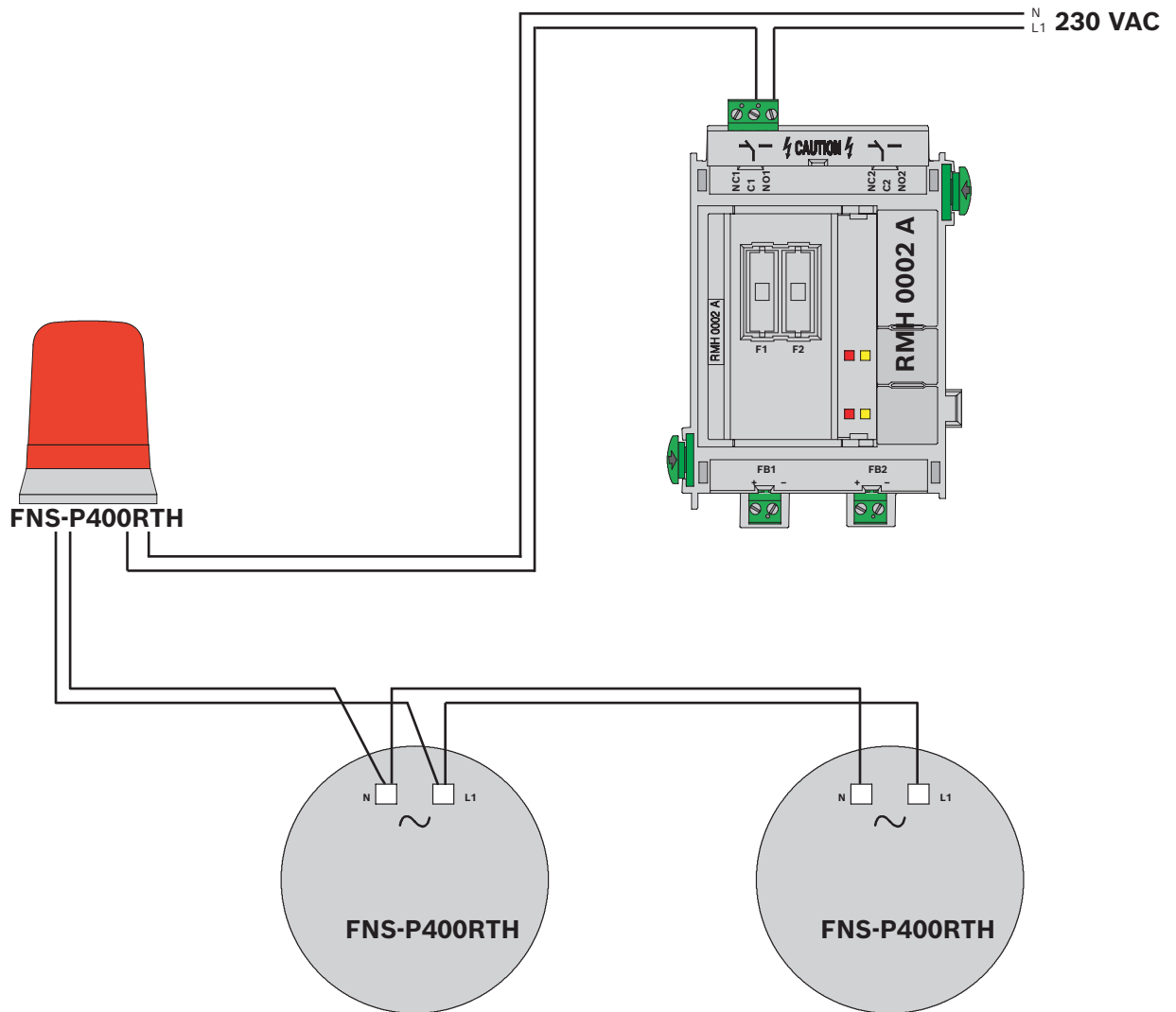
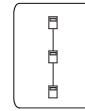

### 2.4.7 IOS 0020 A

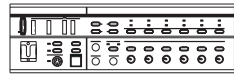
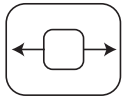

Plena

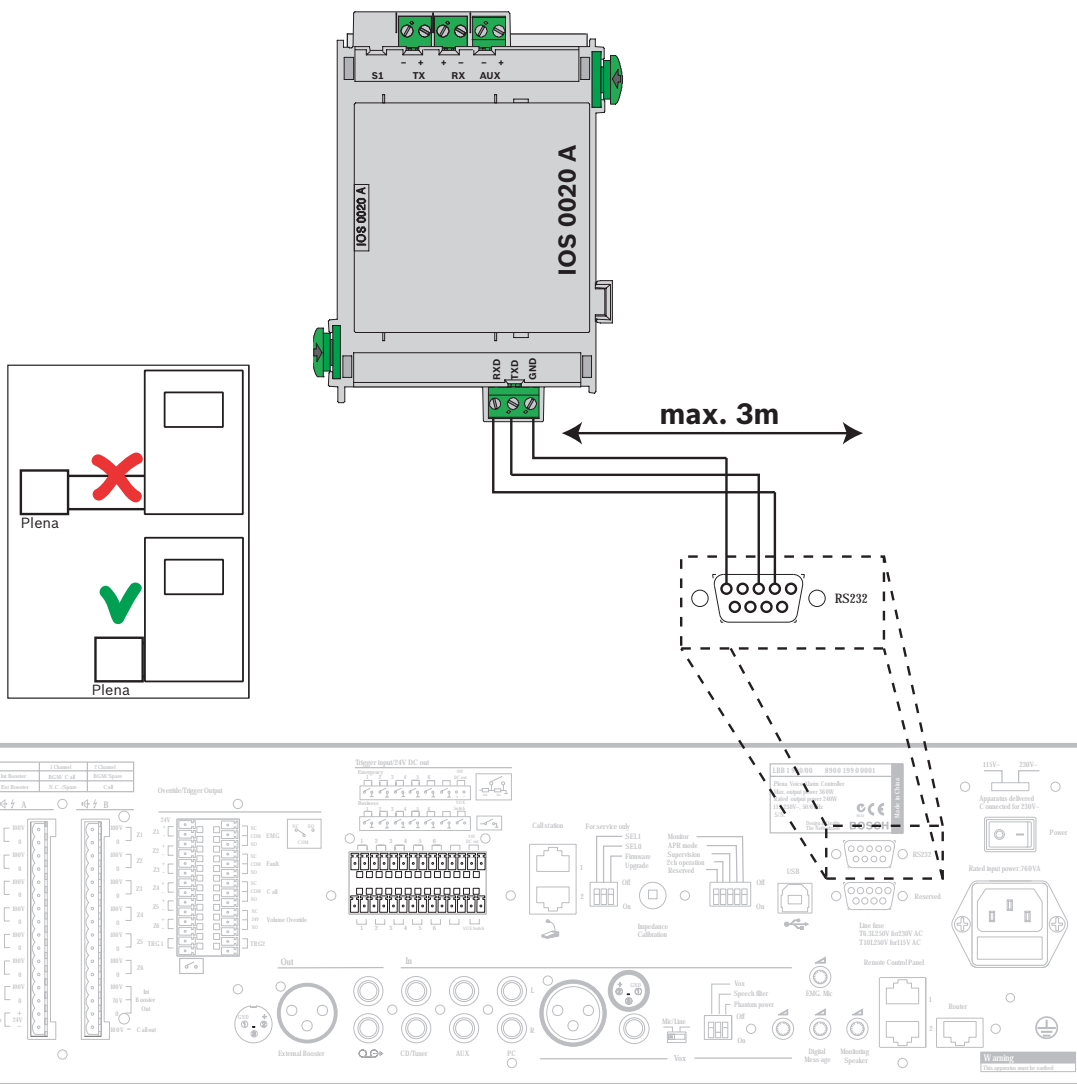





FAT4000 FBF4000 ADP4000

FMF-FAT FMF-FBF-FAT  
FMF-FIBS-A4/-A3  
FMF-ADP

ELS

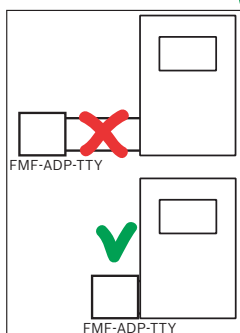
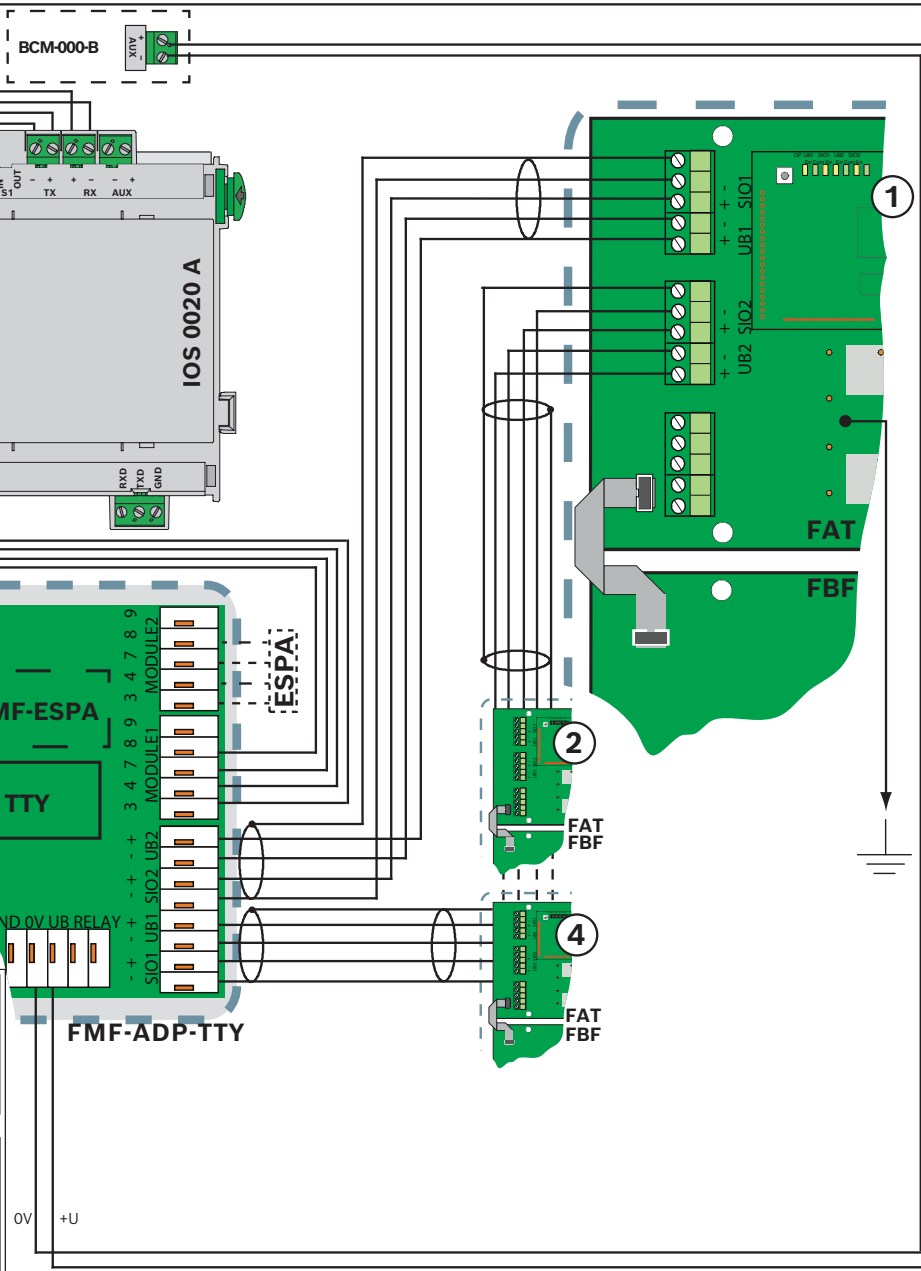

2.4.8

FPE-5000-UGM



FAT4000 FBF4000 ADP4000  
 FMF-FAT FMF-FBF-FAT  
 FMF-FIBS-A4/-A3  
 FMF-ADP

ELS

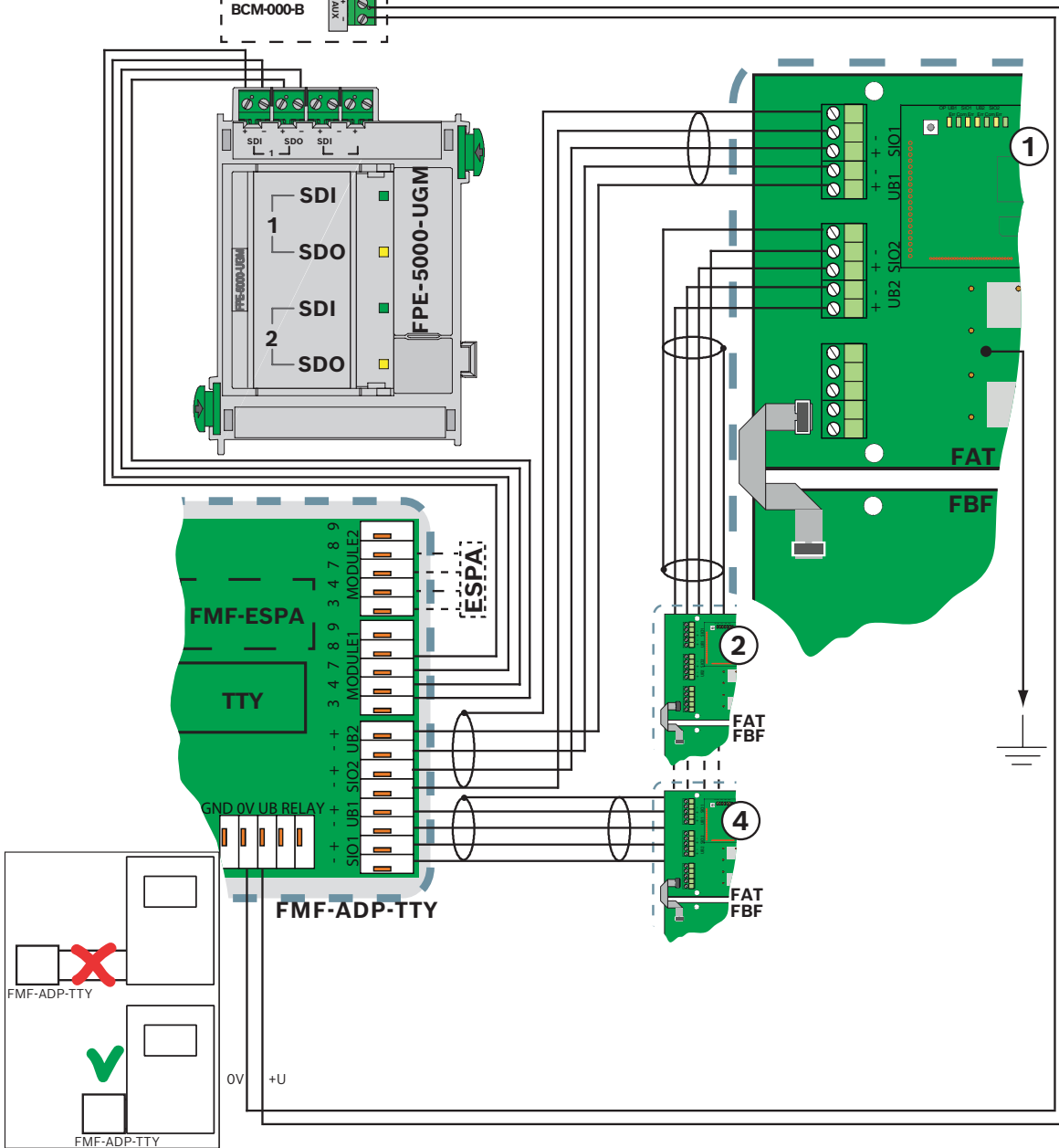
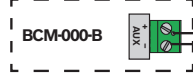

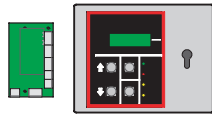

FAT2002RE  
ADP-NE

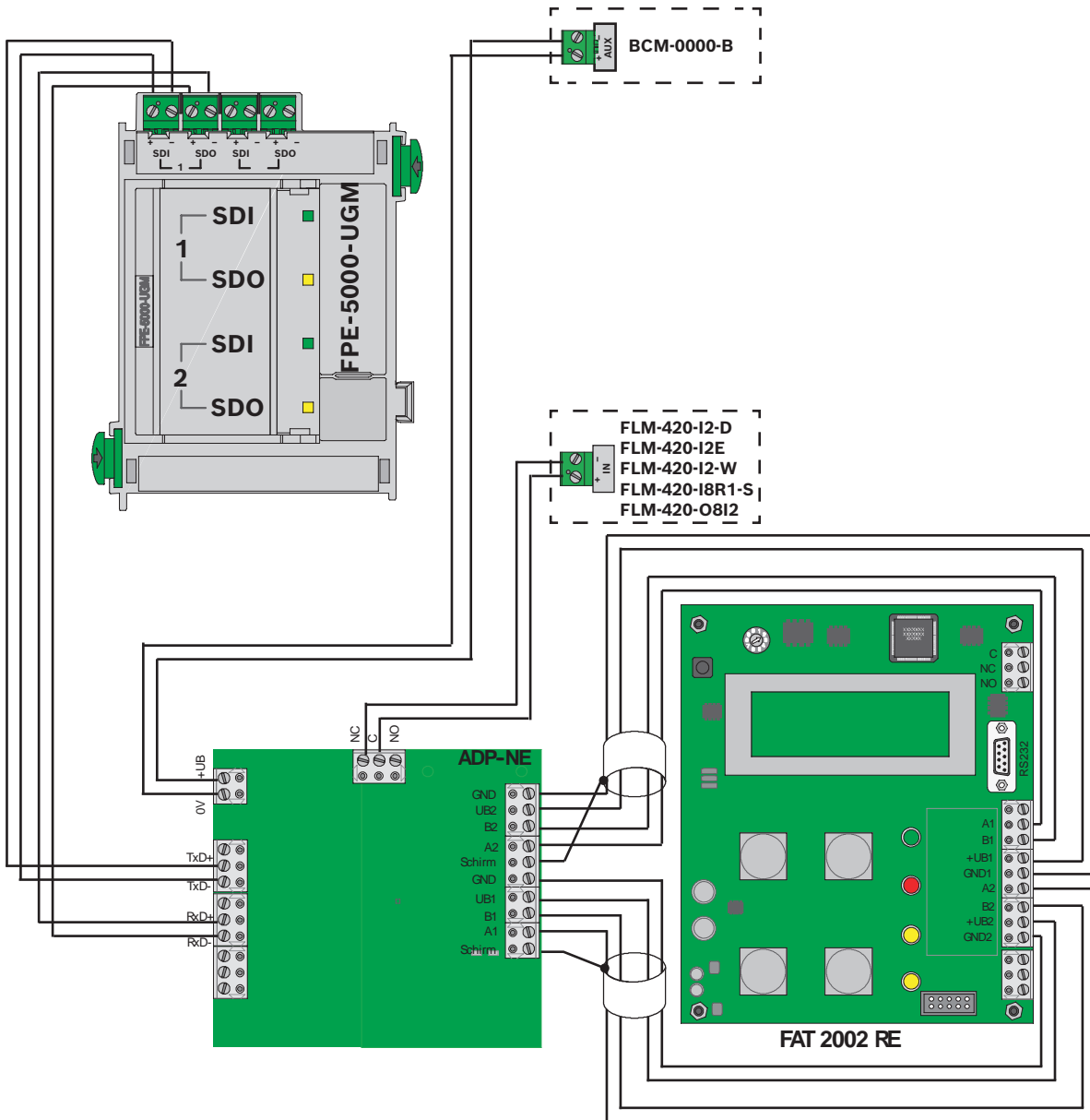

## 2.5

### Interface Modules



*FLM-420-4/CON-D/S, Seite 125*

*FLM-420-I8R1-S, Seite 158*

*FLM-420-NAC-D/S, Seite 160*

*FLM-420-RHV, Seite 172*

*FLM-420-RLE-S, Seite 184*

*FLM-420-RLV1-E, Seite 185*

*FLM-420-RLV8-S, Seite 186*

*FMF-ADP-FBF/FMF-ADP-TTY, Seite 187*

### 2.5.1 FLM-420-4/CON-D/S

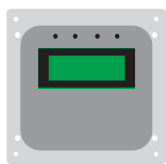

ALARMLINE II

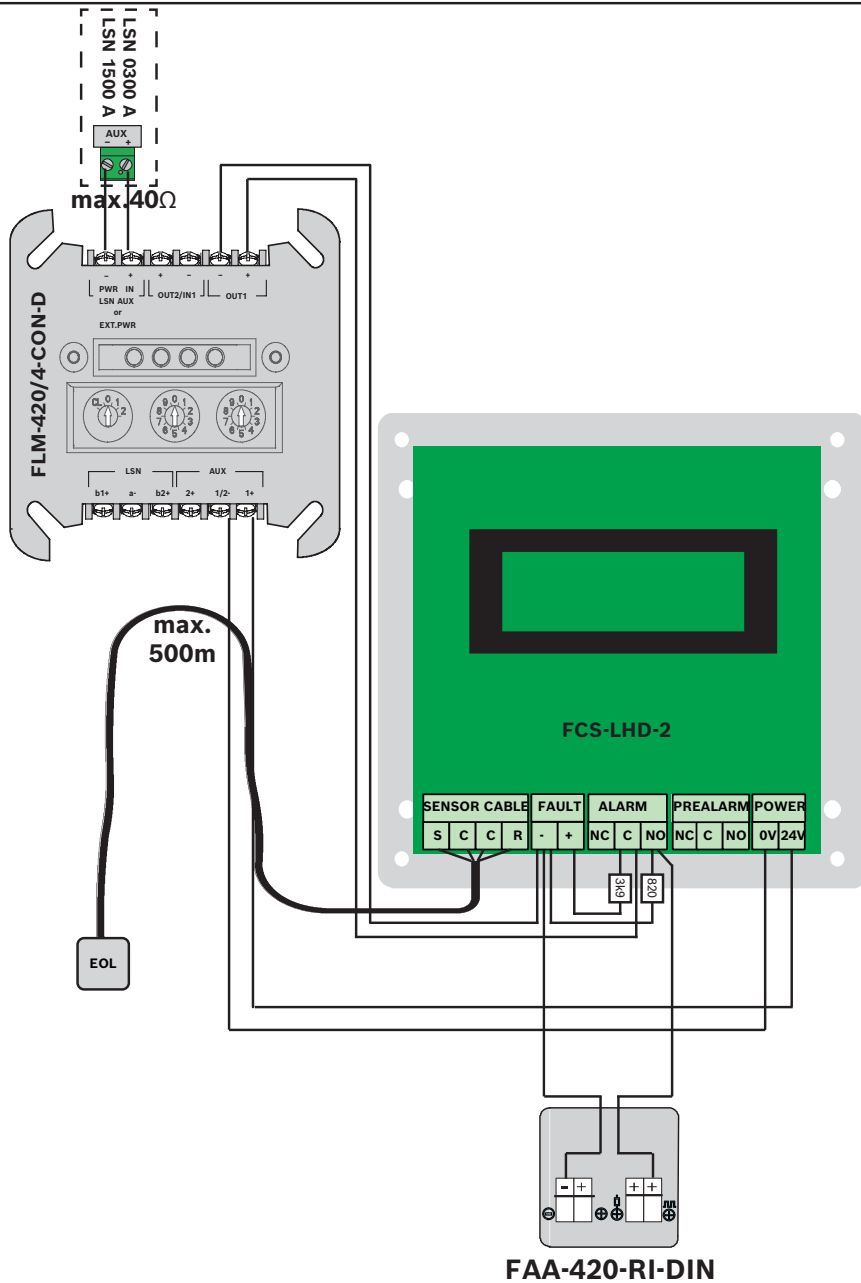
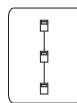



FCS-LWM-1

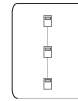

ELS

BCM-0000-B  
LSN 0300 A  
LSN 1500 A

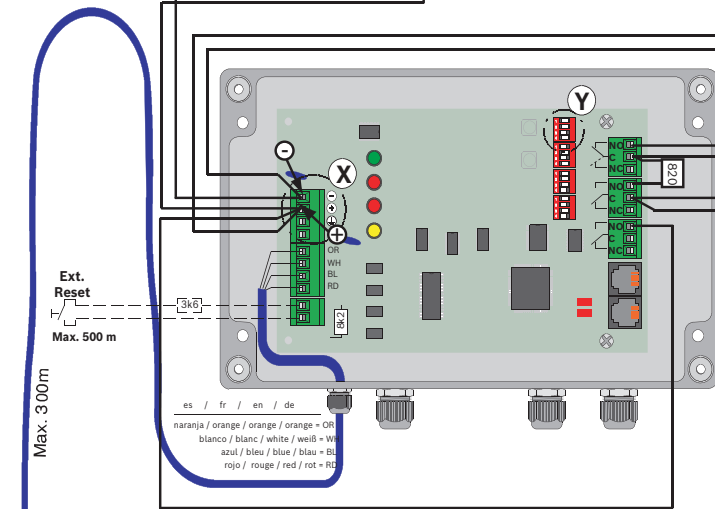
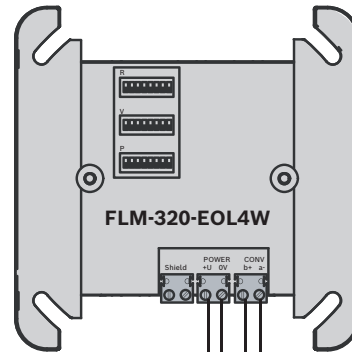
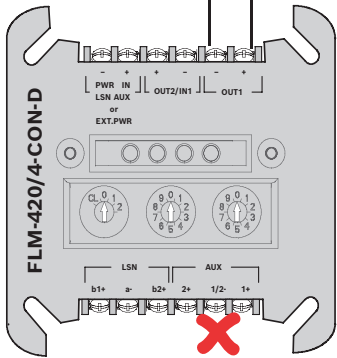



FCS-LWM-1

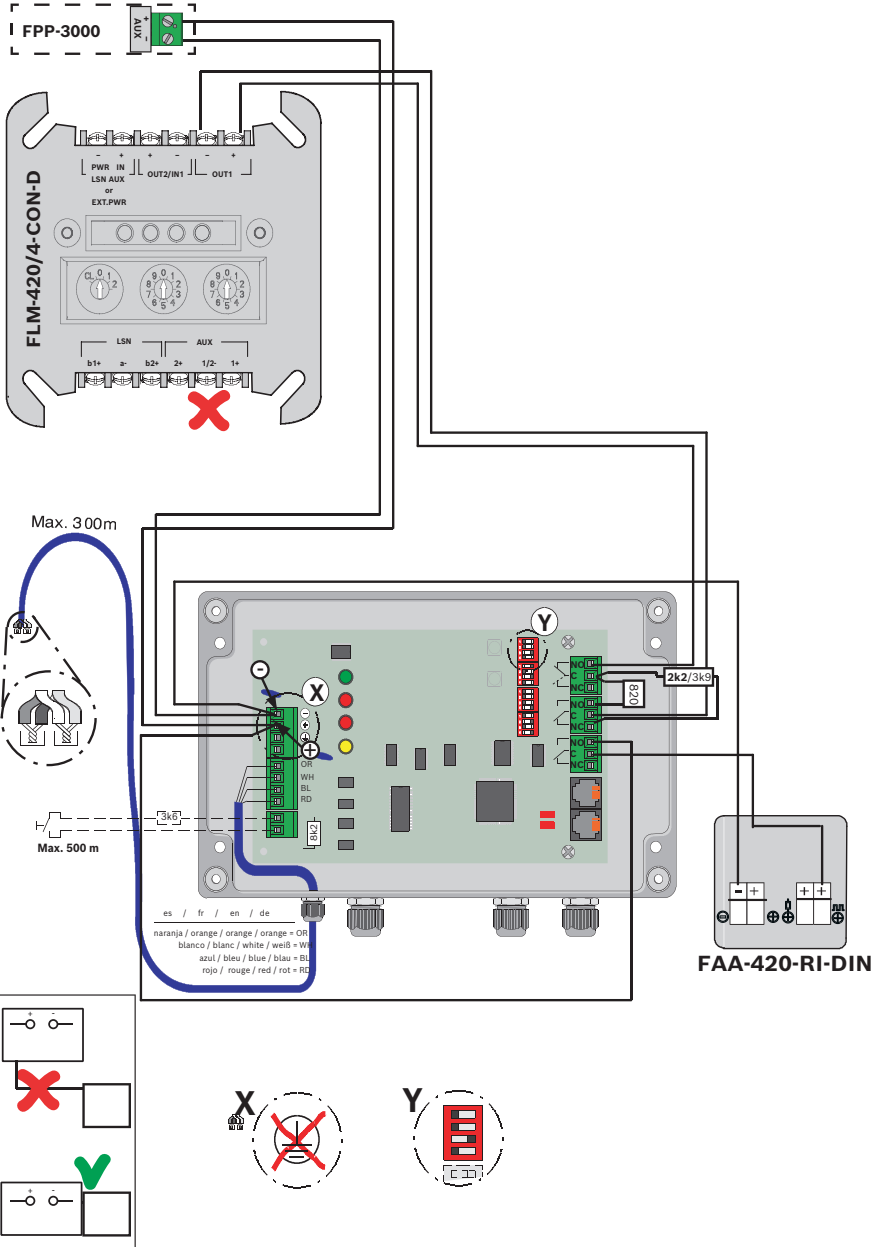



FCP-500

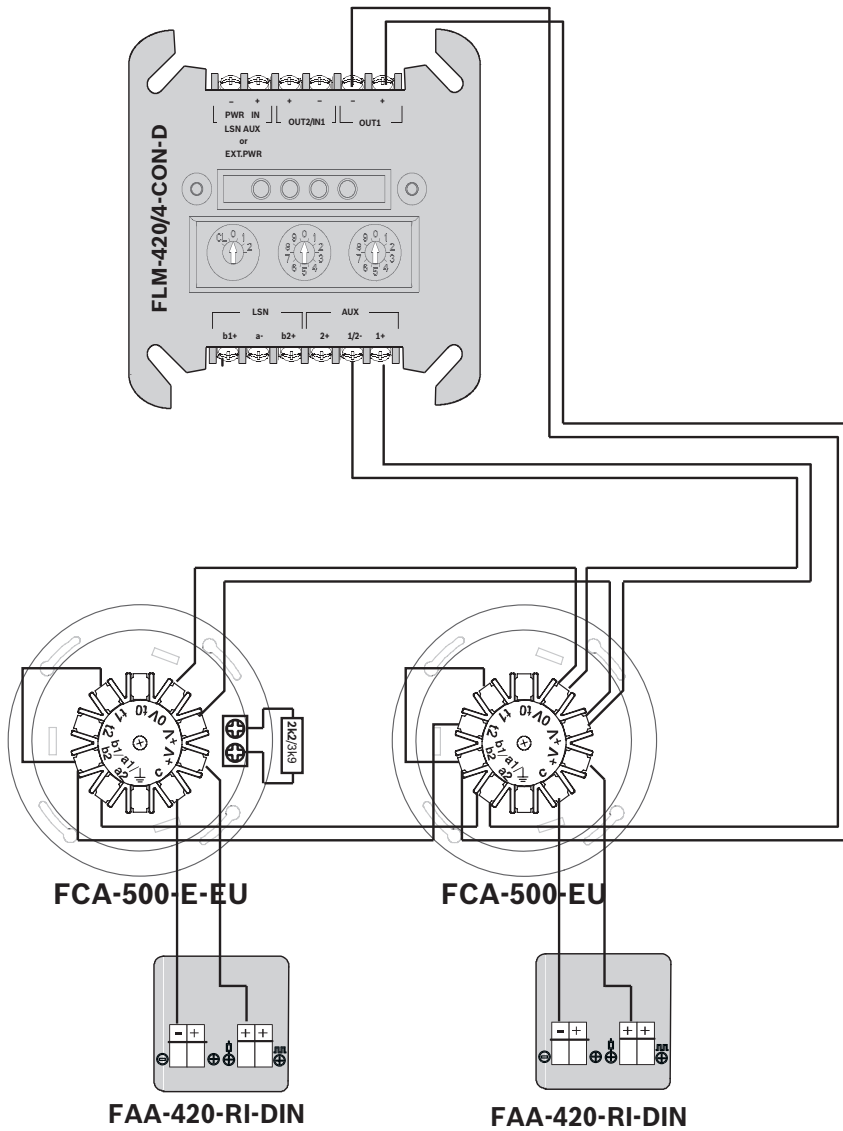





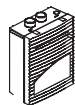

FCS-320-TM Series



BCM-0000-B  
LSN 0300 A  
LSN 1500 A

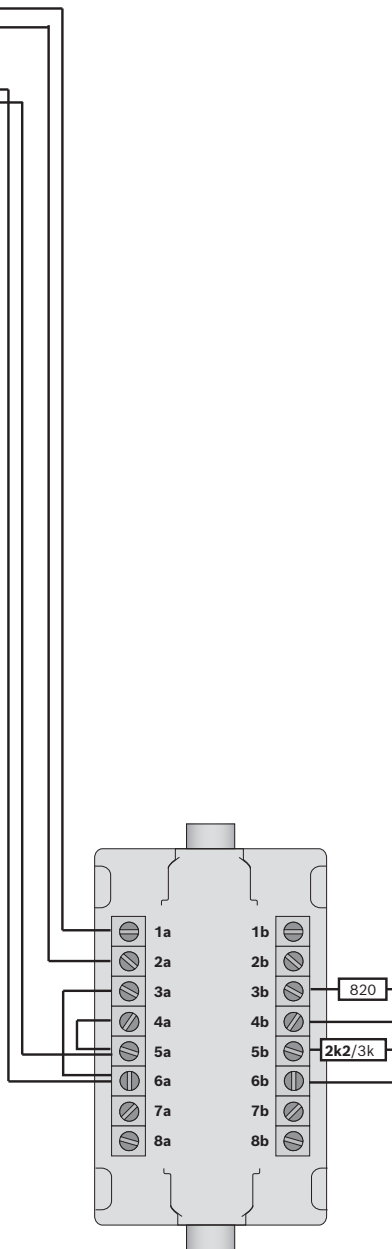
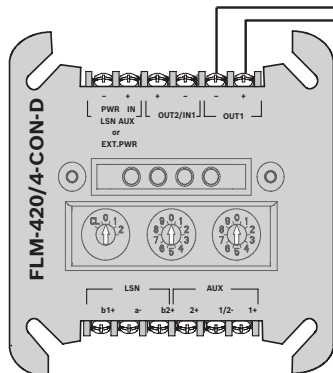

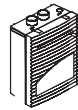

FCS-320-TP Series

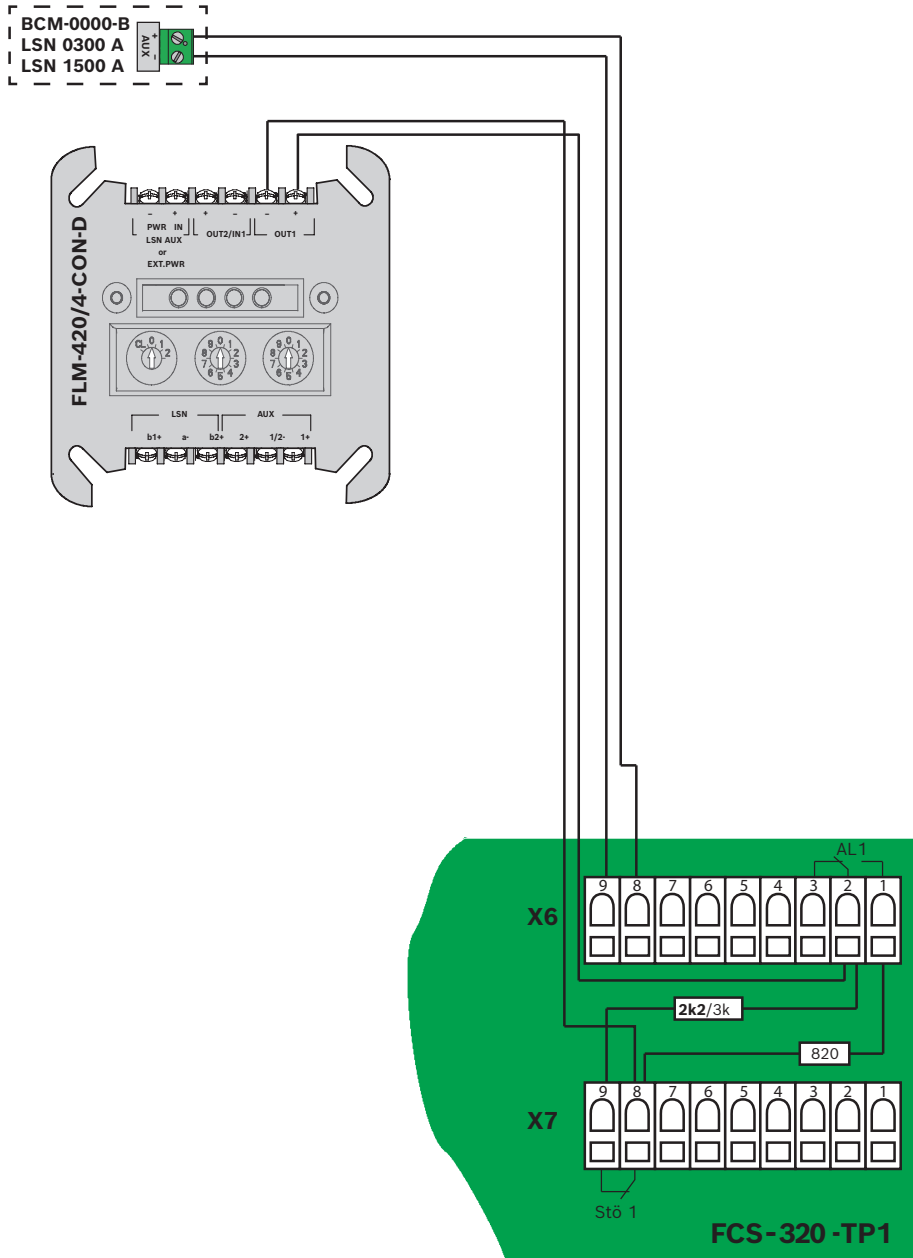
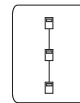

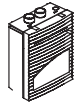

FCS-320-TP Series

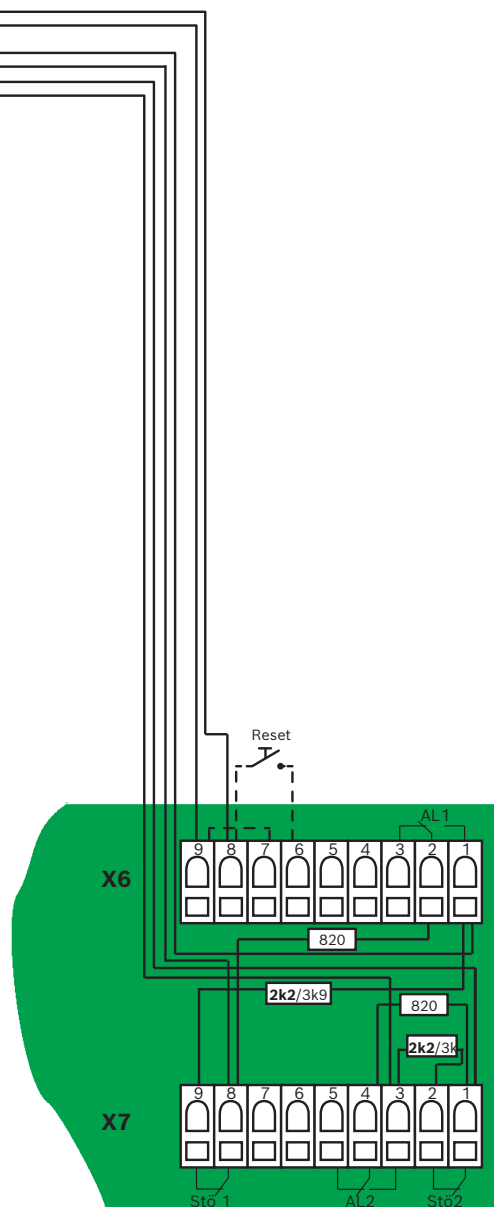
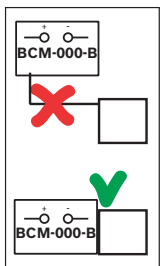
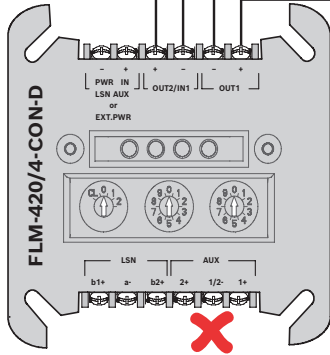
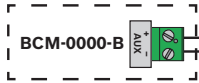

FCS-320-TP2

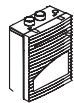

FCS-320-TP1

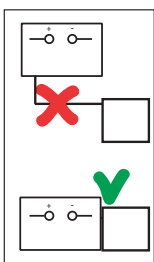
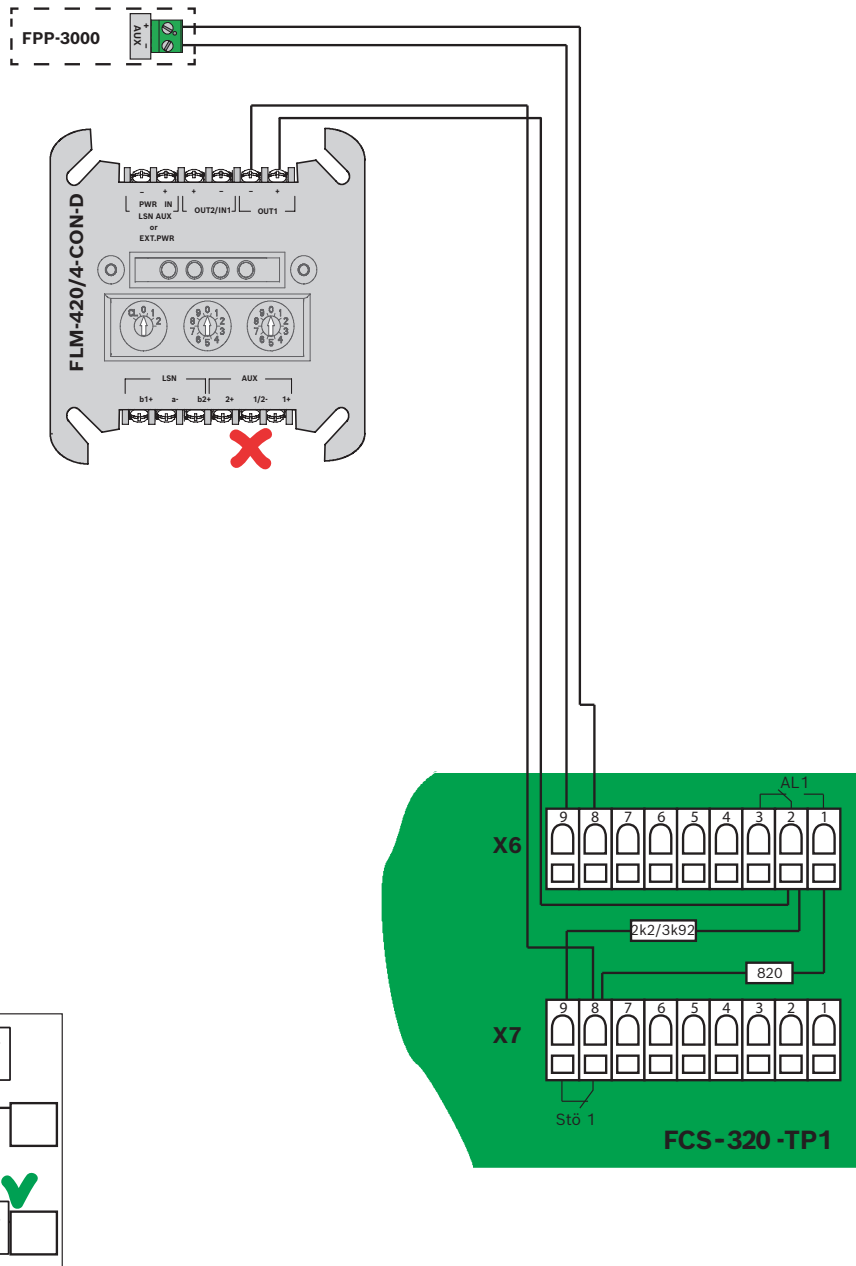

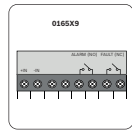

**016519, 016589  
IR3 Flame Detector**

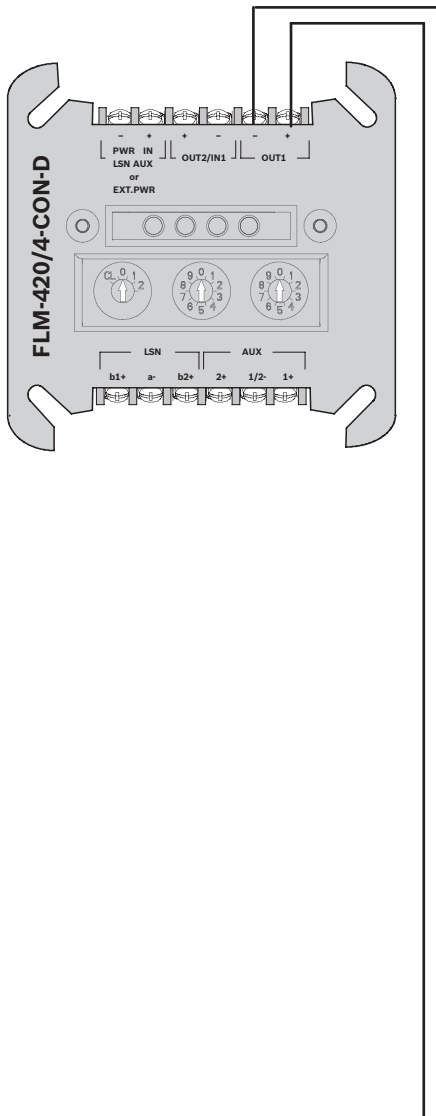
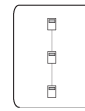

**max. 1 x 0165X9**

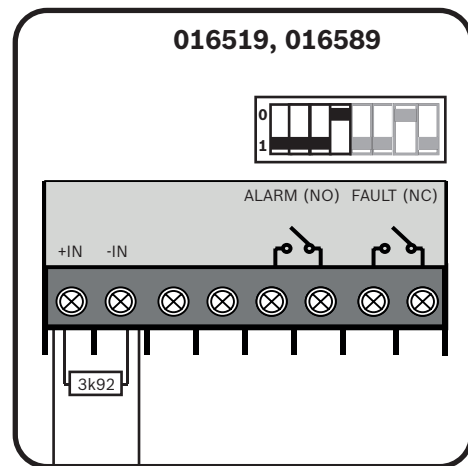

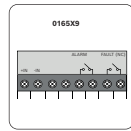

**016519, 016589  
IR3 Flame Detector**

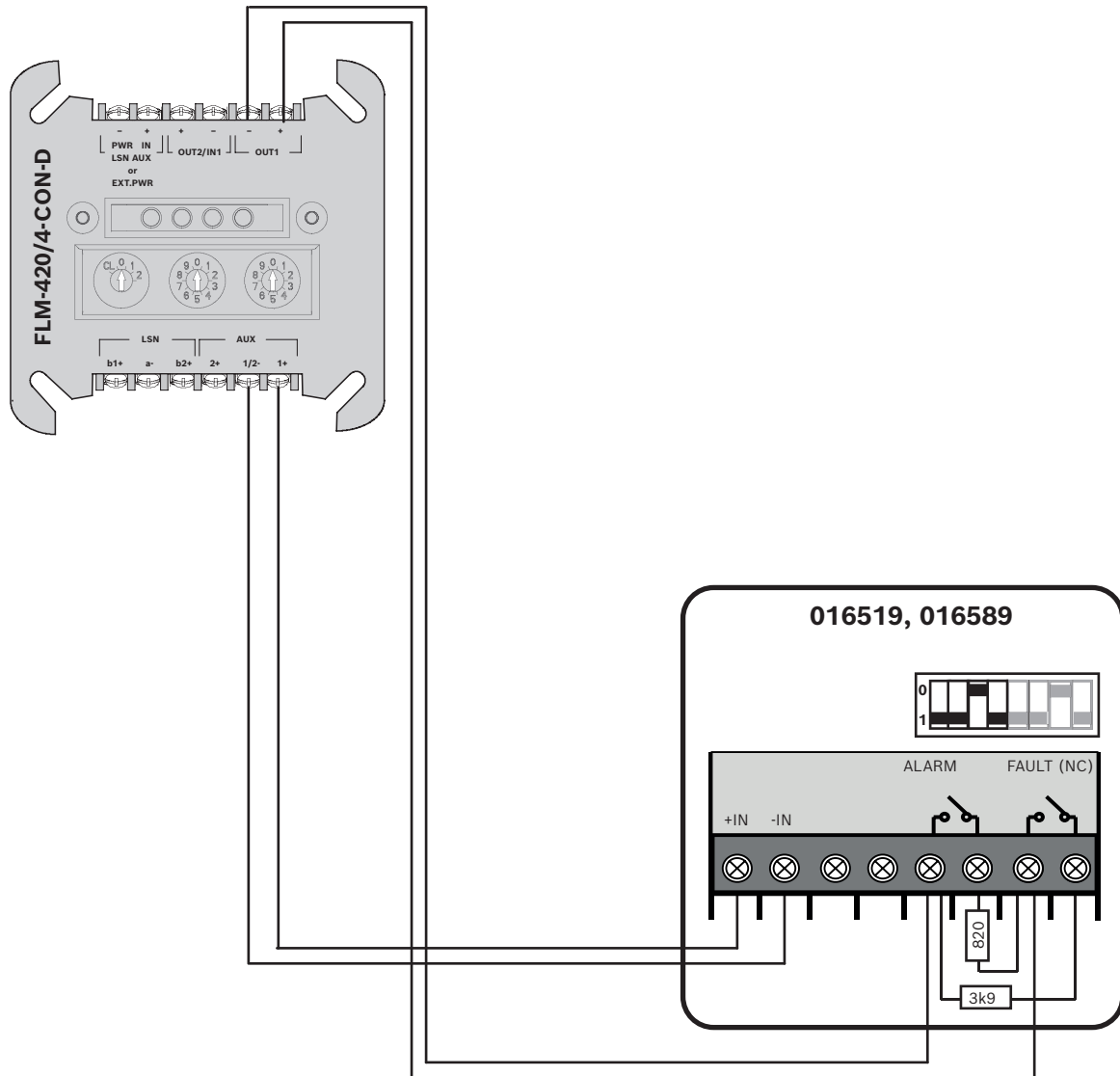
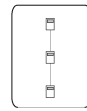

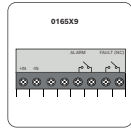

**016519, 016589  
IR3 Flame Detector**

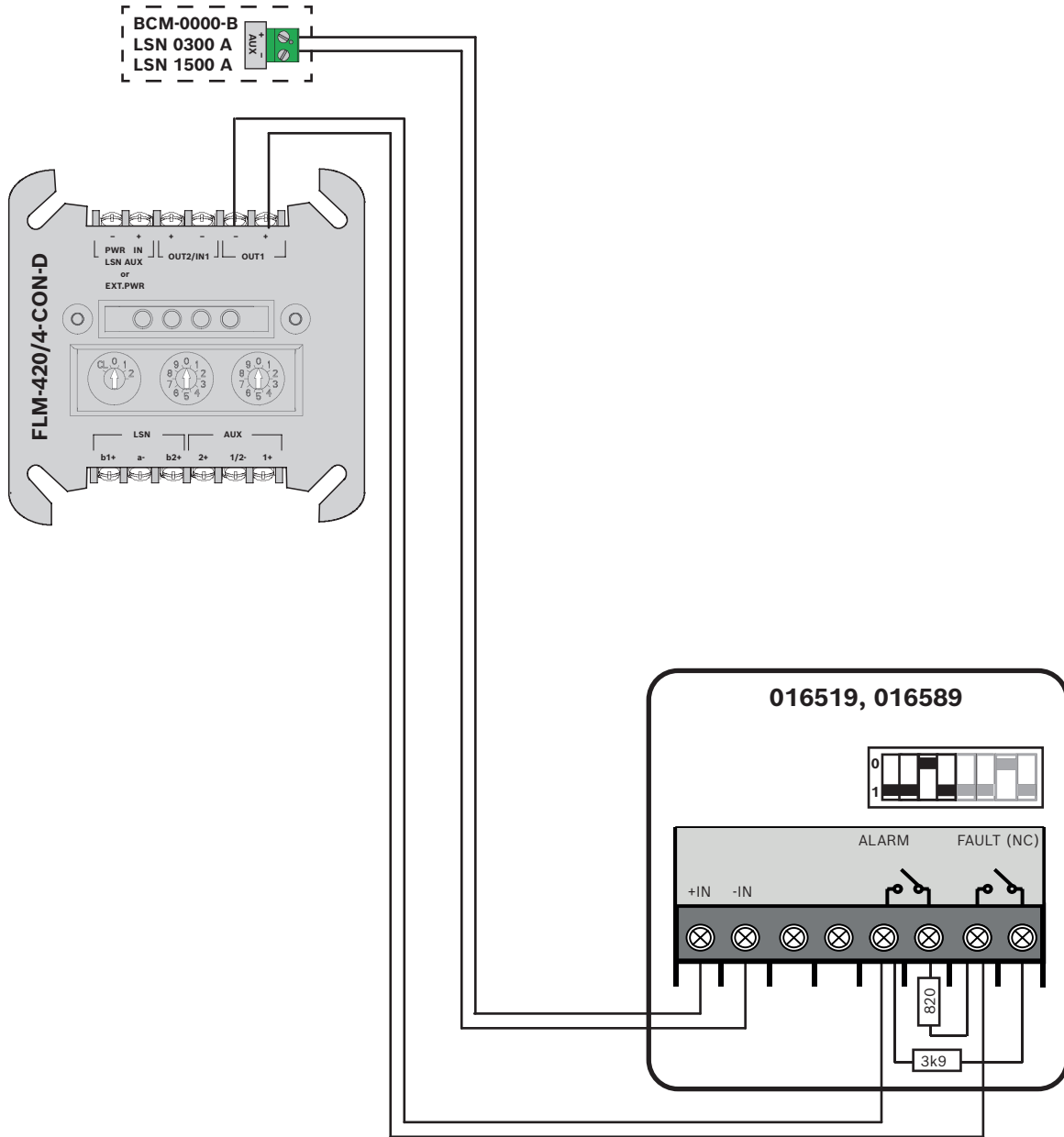
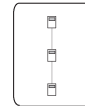



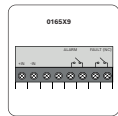

**016519, 016589  
IR3 Flame Detector**

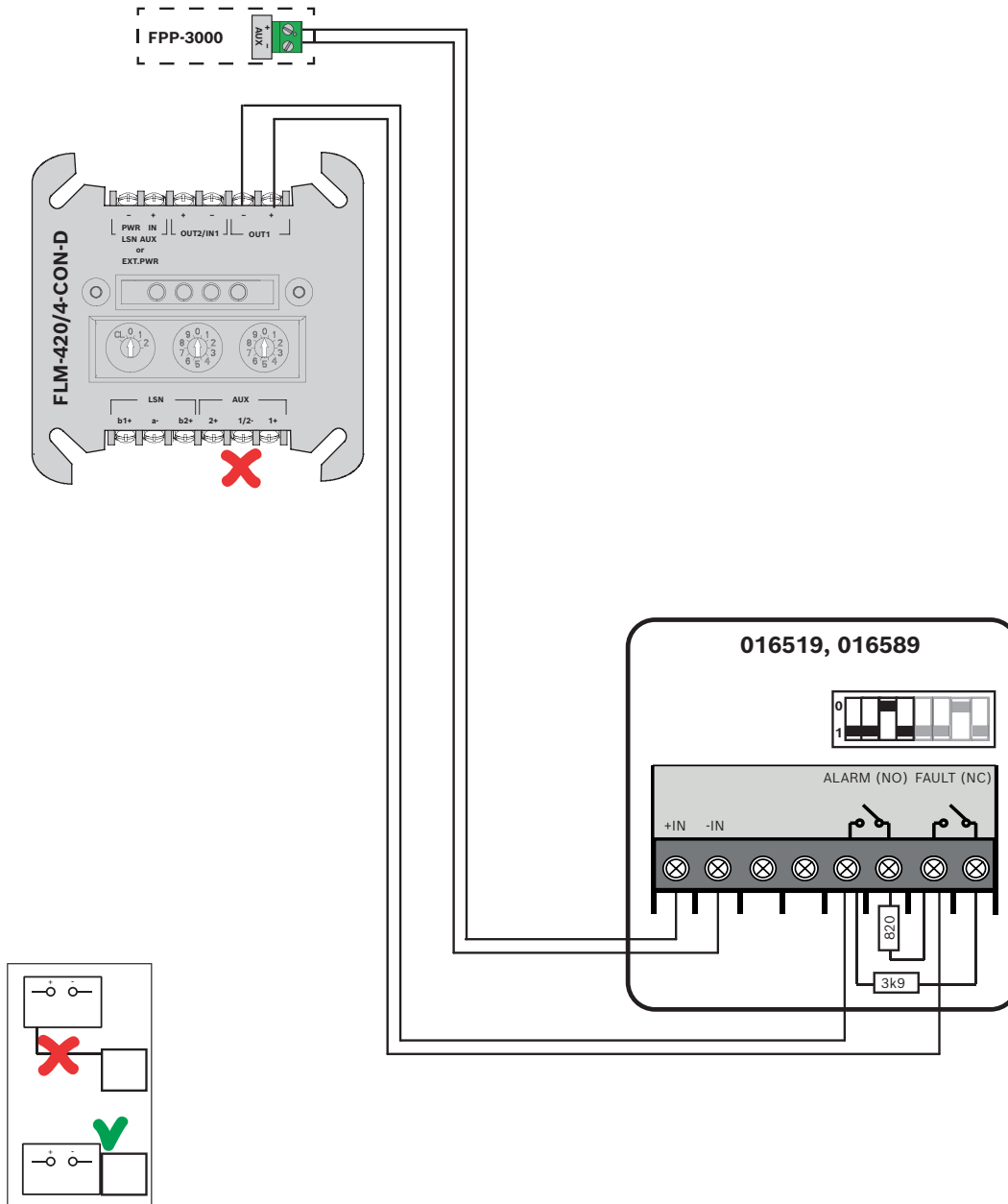



**Fireray 50RV  
Fireray 100RV**

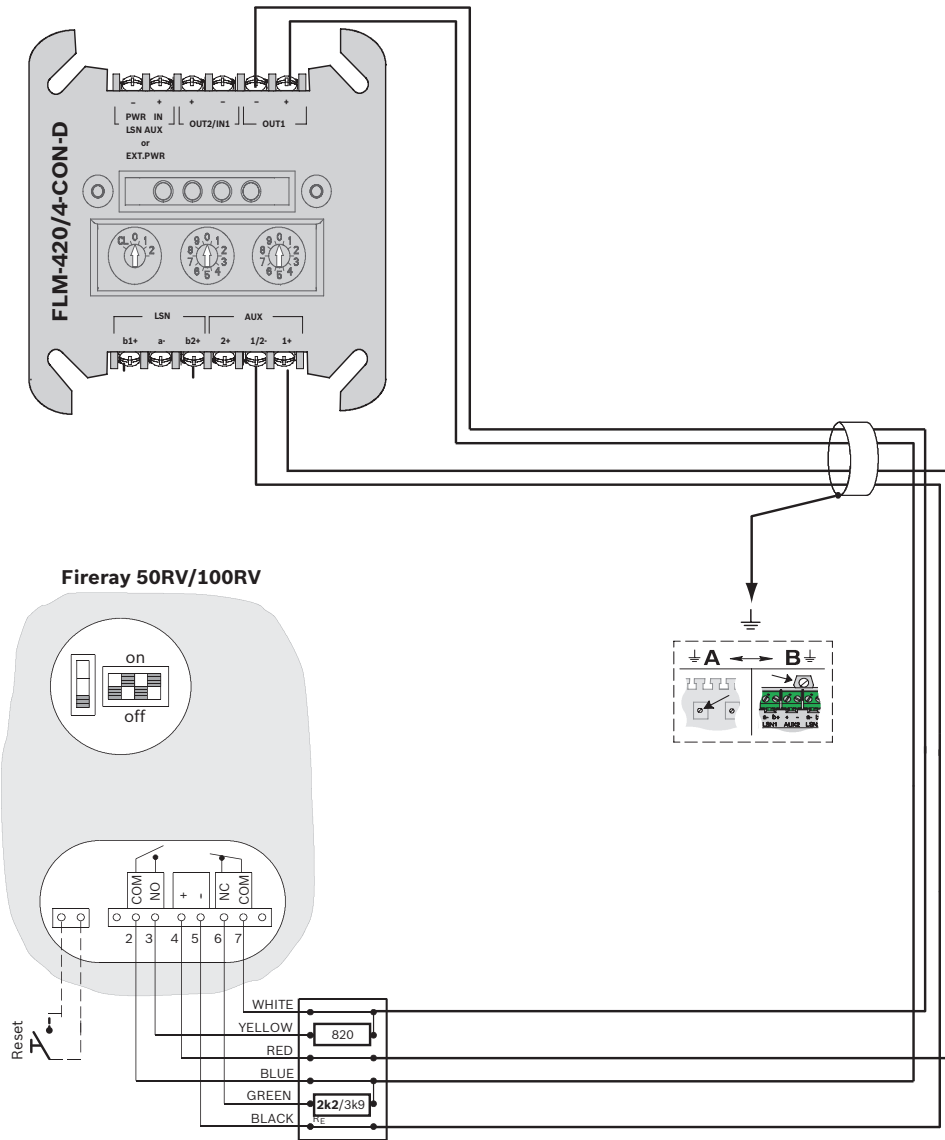



**FIRERAY3000**

1 x

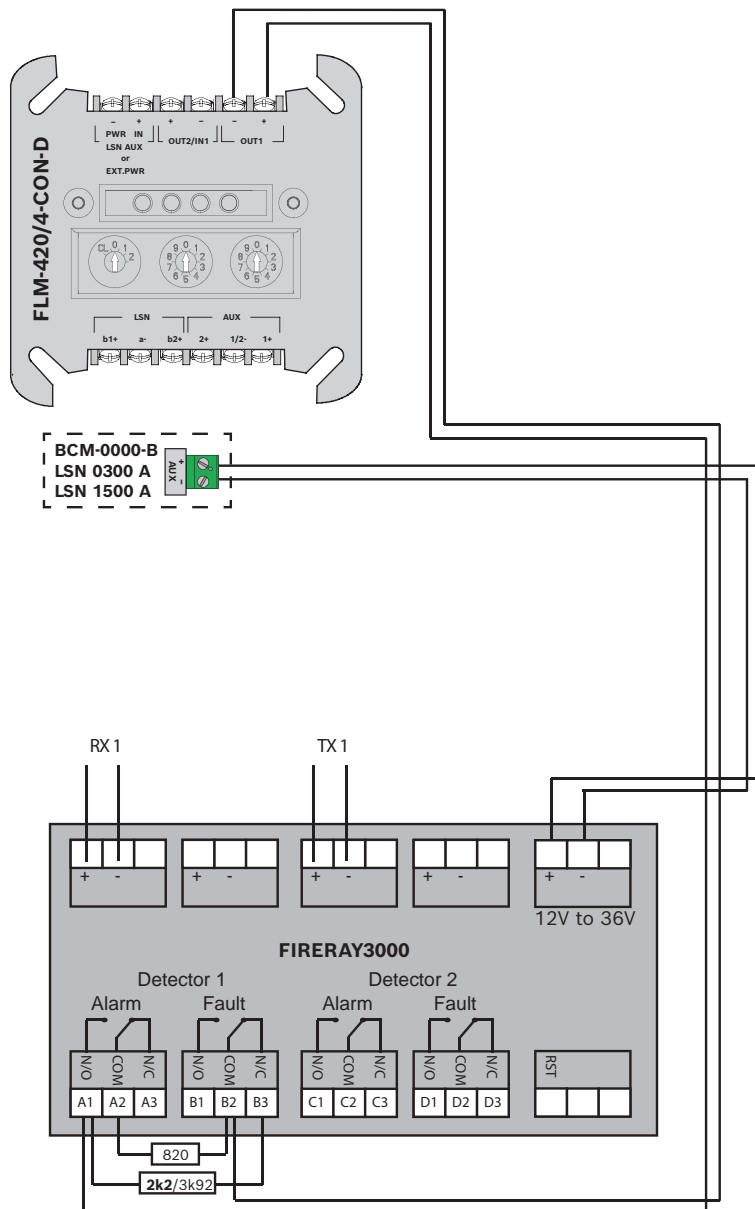



**FIRERAY3000**

2 x **OUT1**

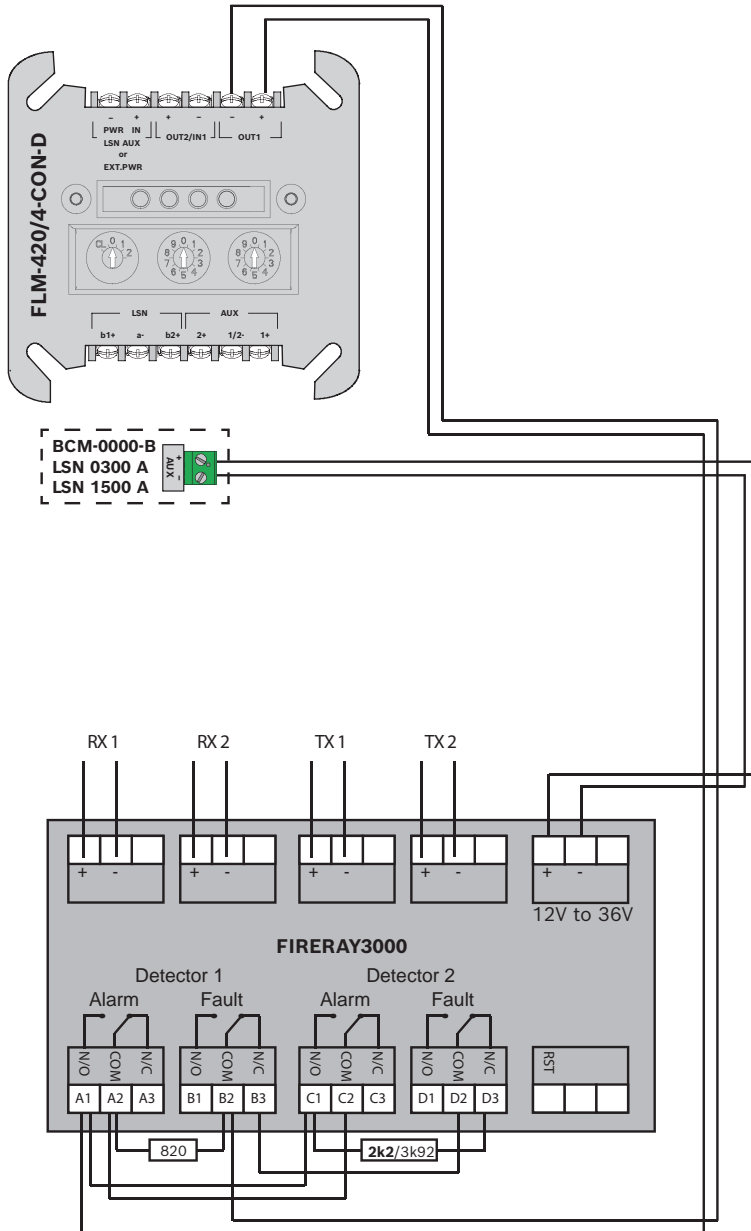



**FIRERAY3000**

2 x **OUT1+2**

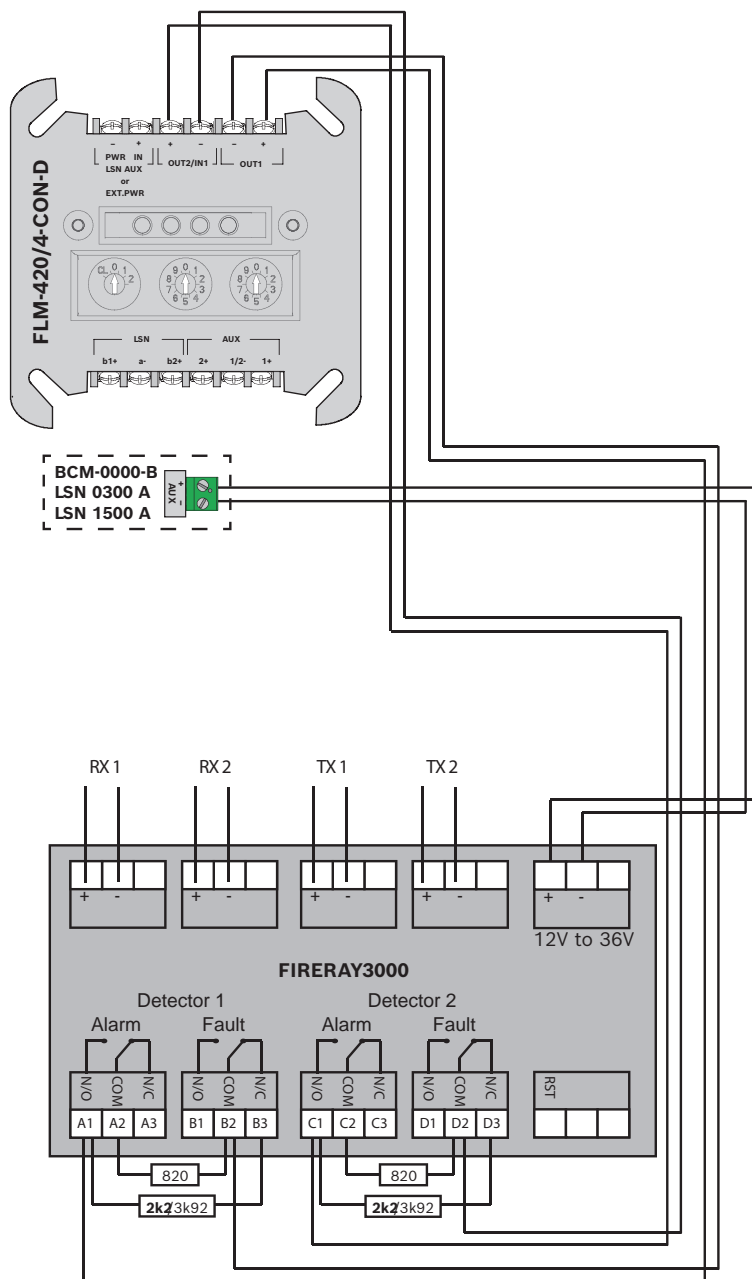

**Reset action**



**FIRERAY5000**

1 x

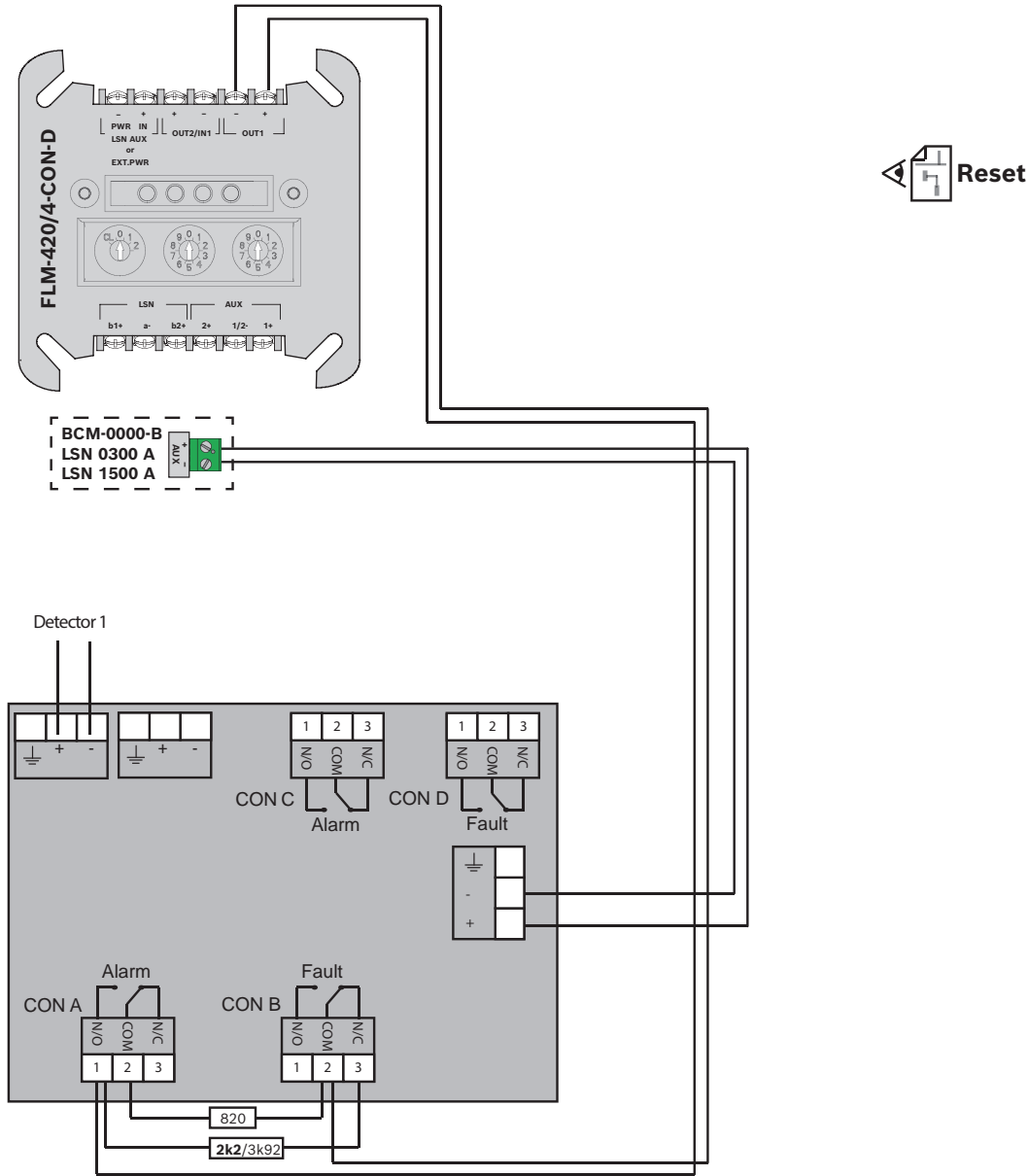



**FIRERAY5000**

**2 x OUT1**

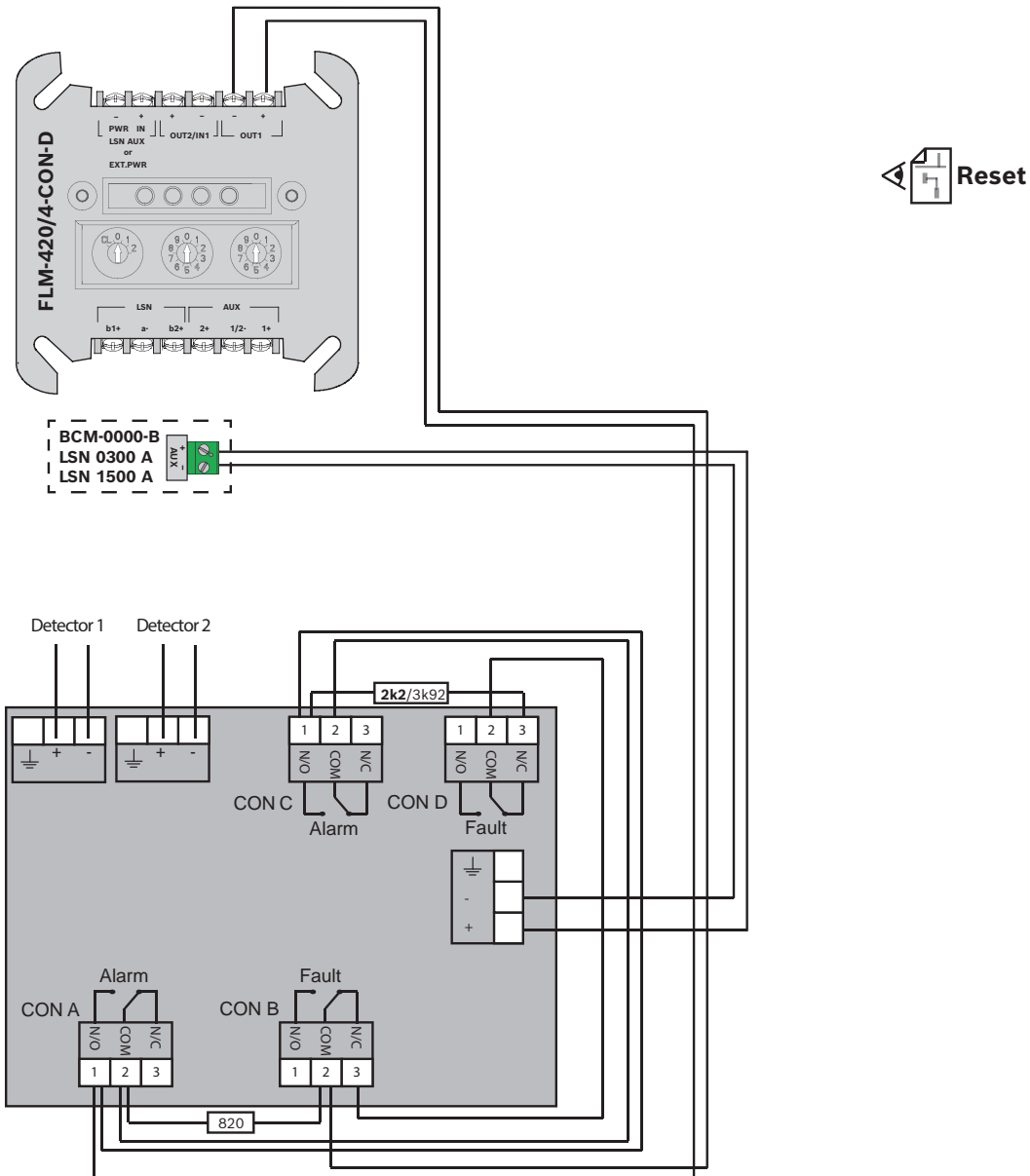

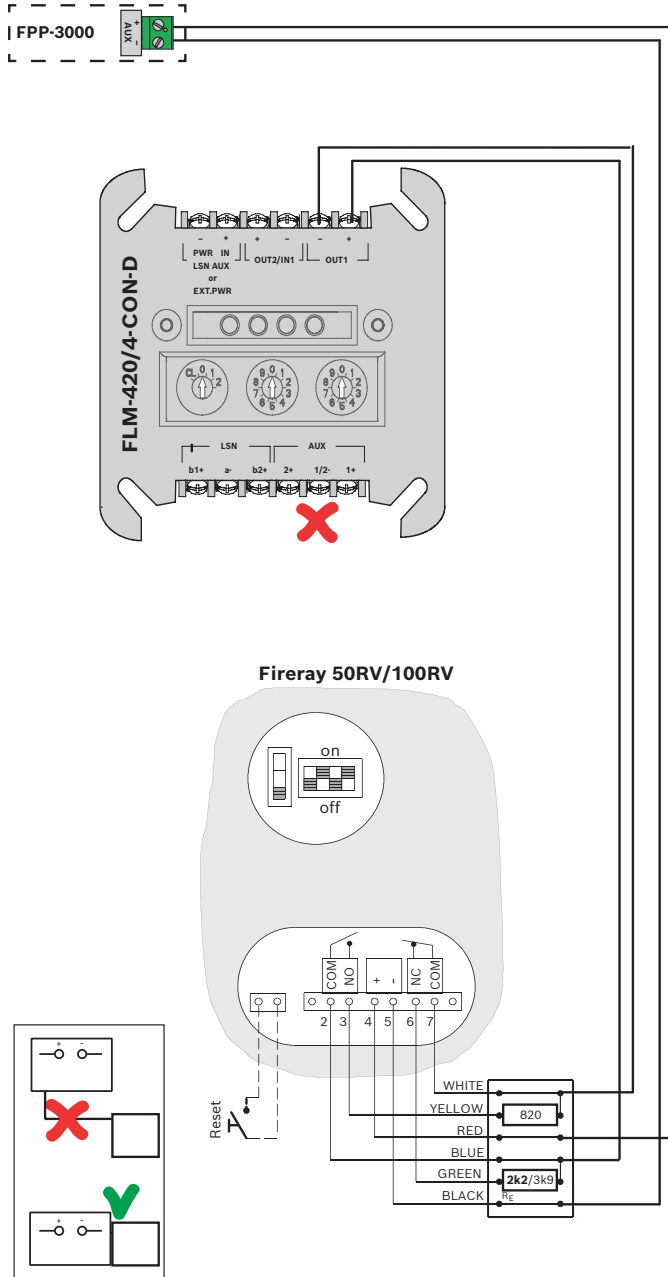





**FIRERAY3000**

1 x

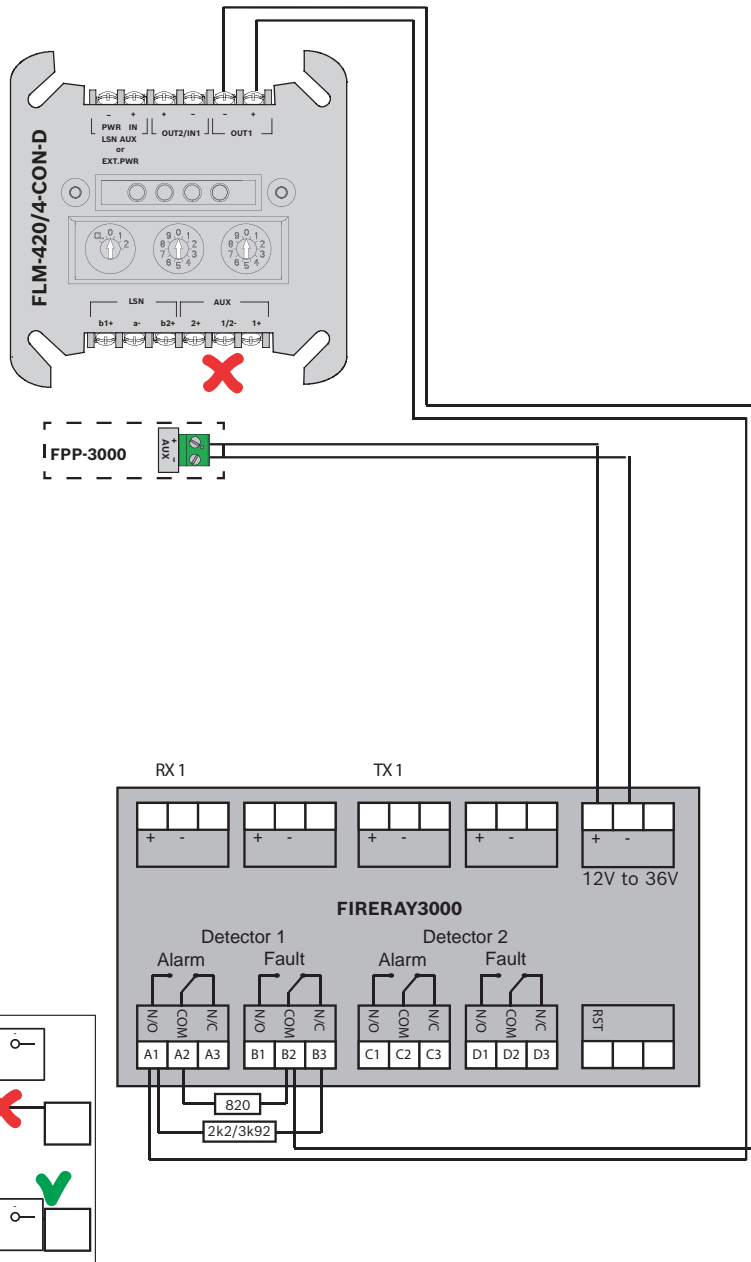

**Reset action**

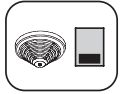

**FIRERAY3000**

2 x  **OUT1**

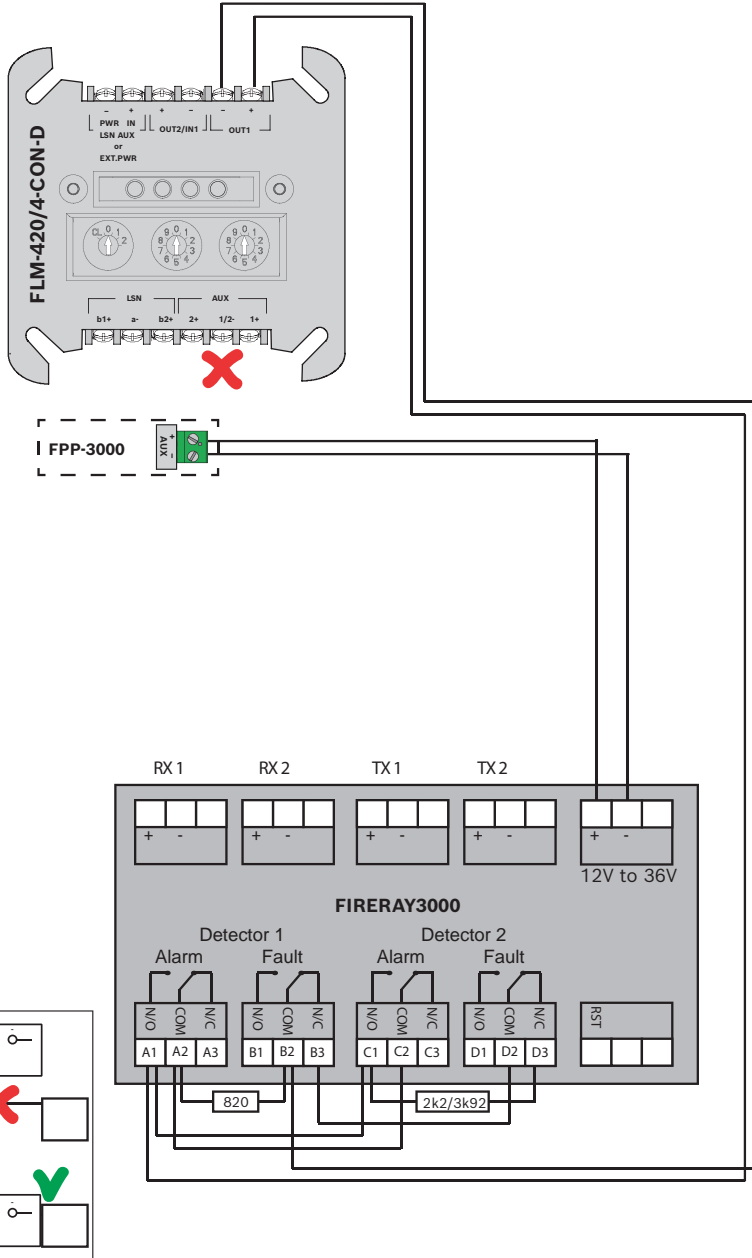

 **Reset action**

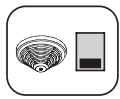

**FIRERAY5000**

1 x

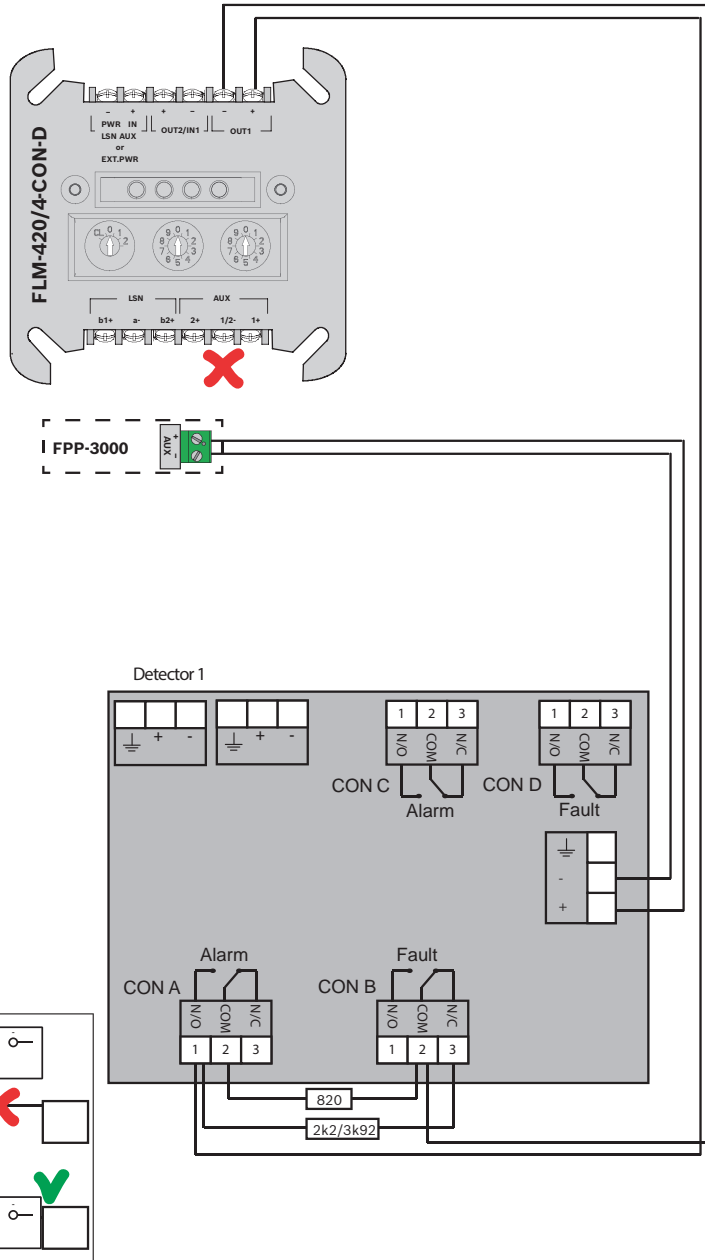

Reset action



**FIRERAY5000**

**2 x OUT1**

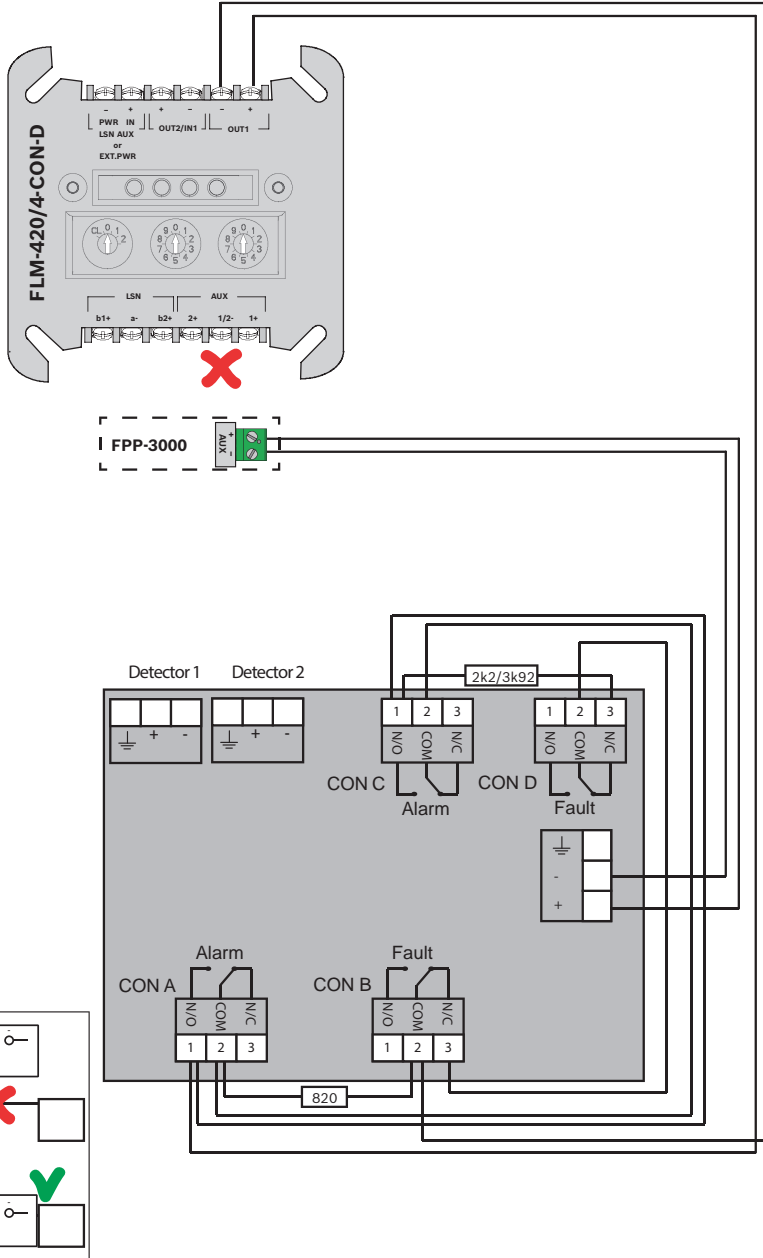

**Reset action**

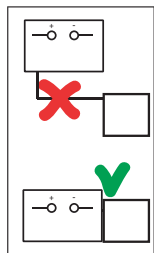





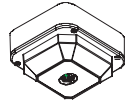

**DF 1192**

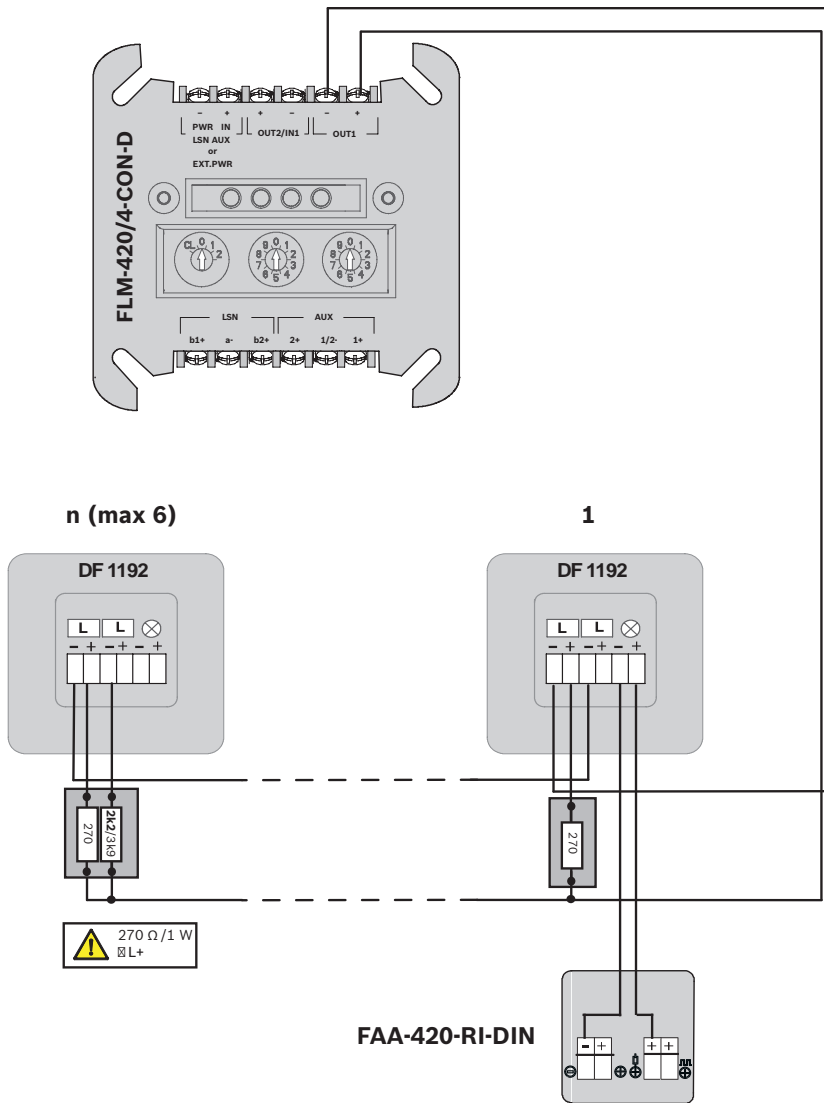

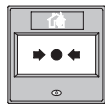
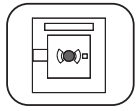

**FMC-300-RW**

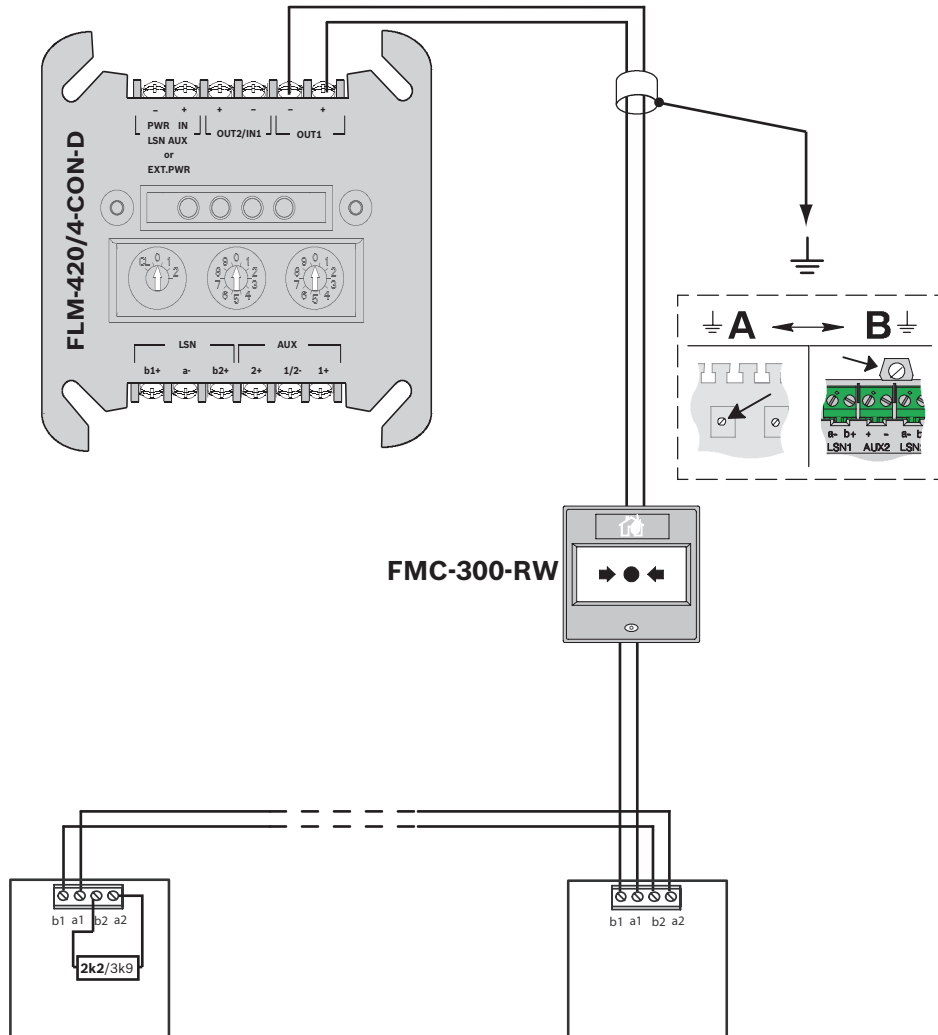
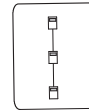





N4387A

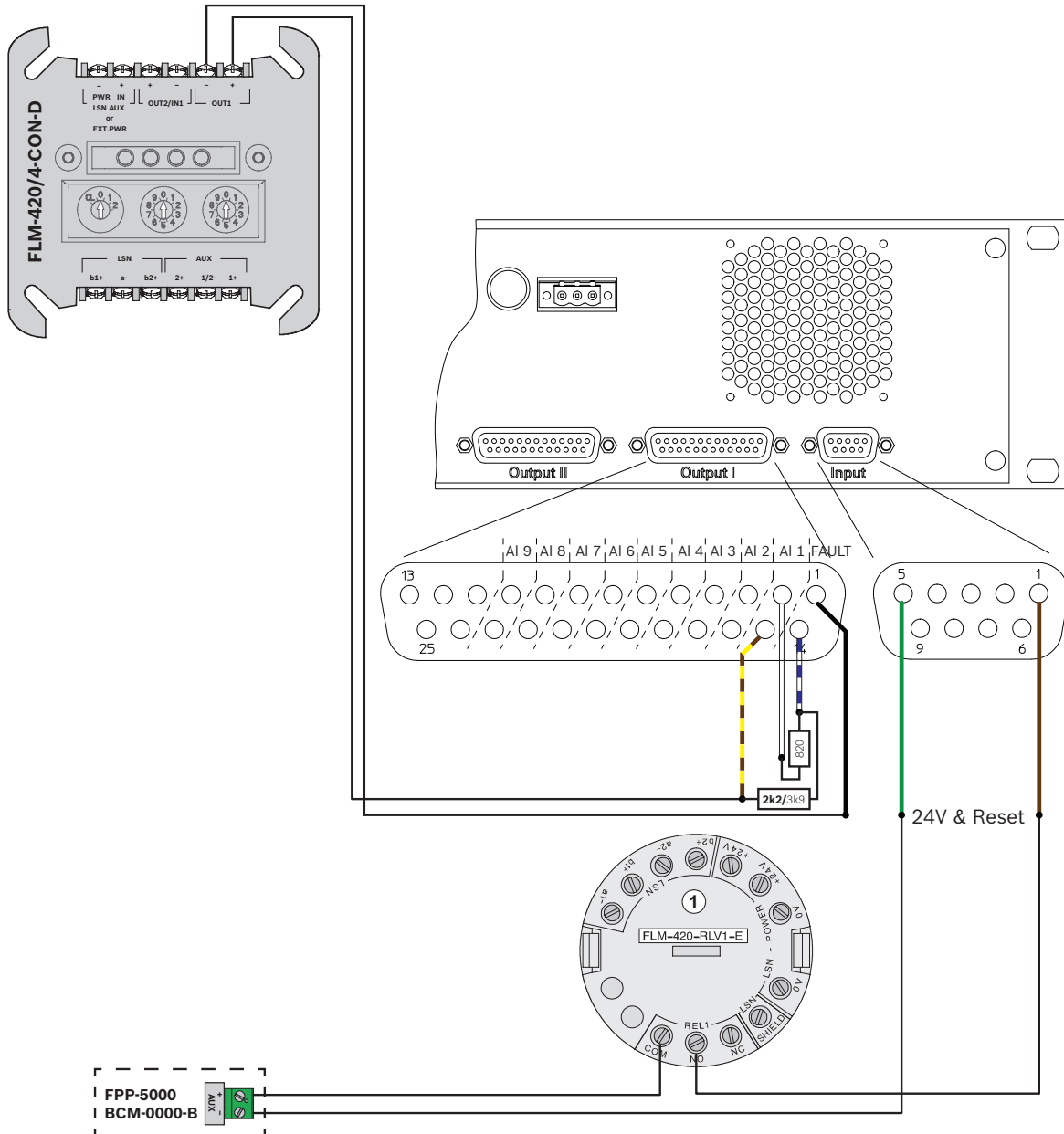

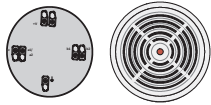

MSS 400, MSS 400 B  
 FCH-320-T320  
 FCH-T320-R470, FCH-T320-FSA  
 FCP-O320, FCP-O320-R470  
 FCP-OC320, FCP-OC320-R470  
 FCP-OT320, FCP-OT320-R470

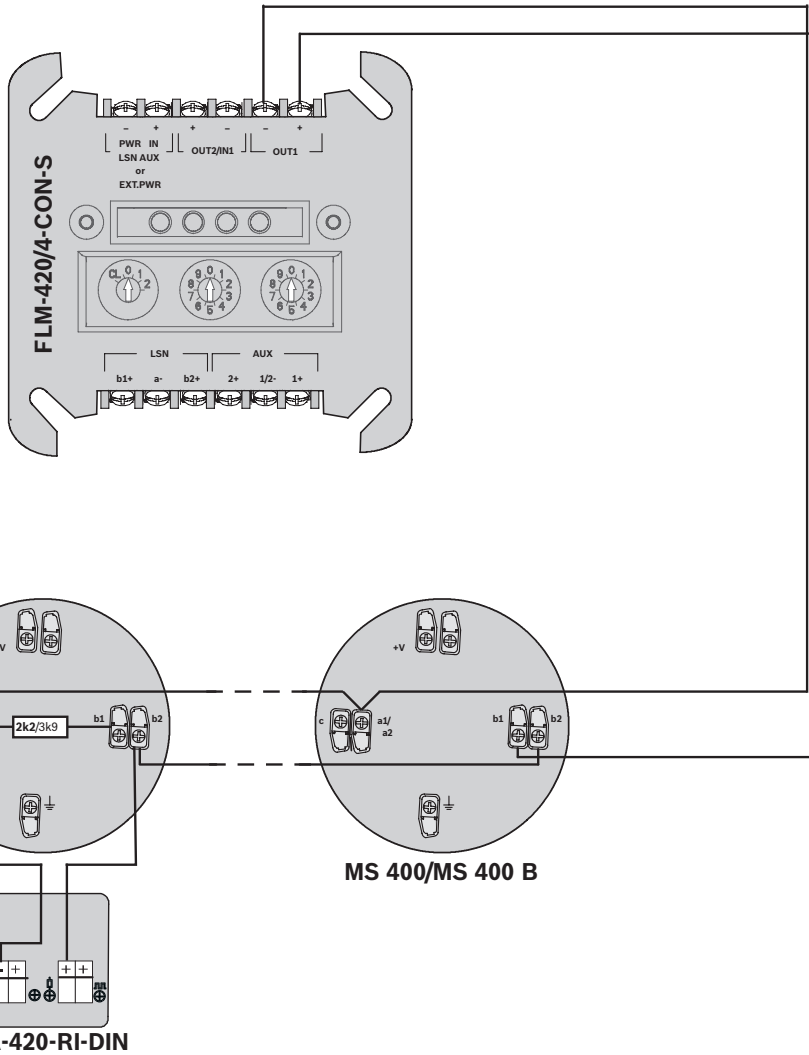

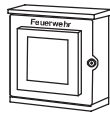
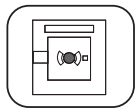

**2014/2 Ex**  
**2014/2 GLU-Ex**

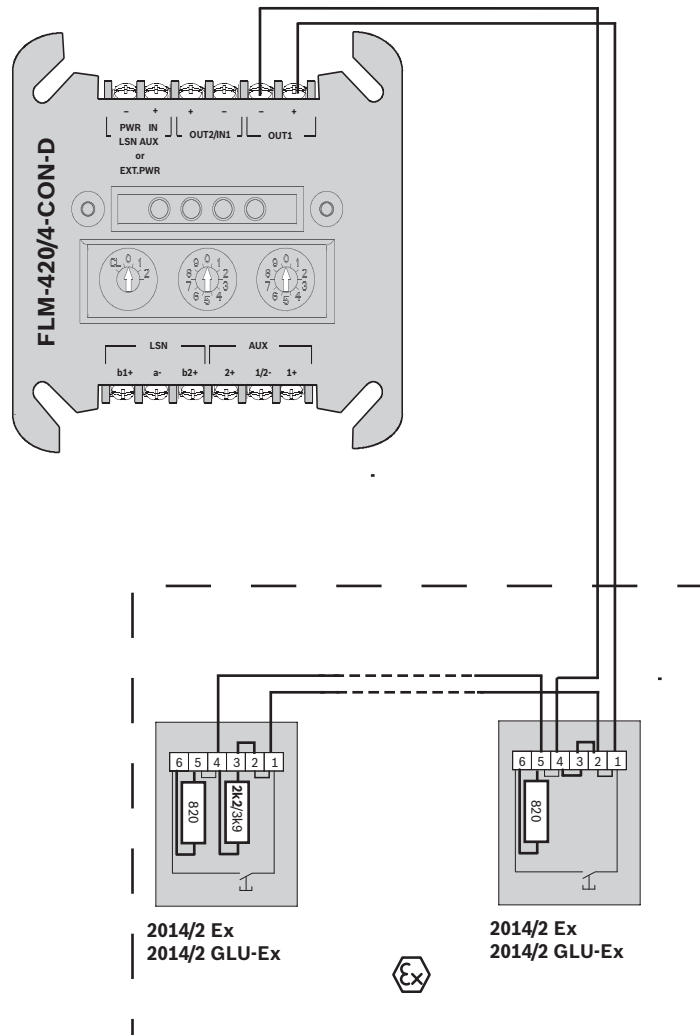
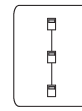

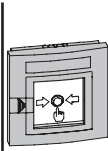
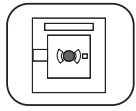

FMC-120-DKM-G-R FMC-120-DKM-G-Y  
 FMC-120-DKM-H-R FMC-120-EST-G-B  
 FMC-120-DKM-G-B  
 FMC-120-DKM-H-B

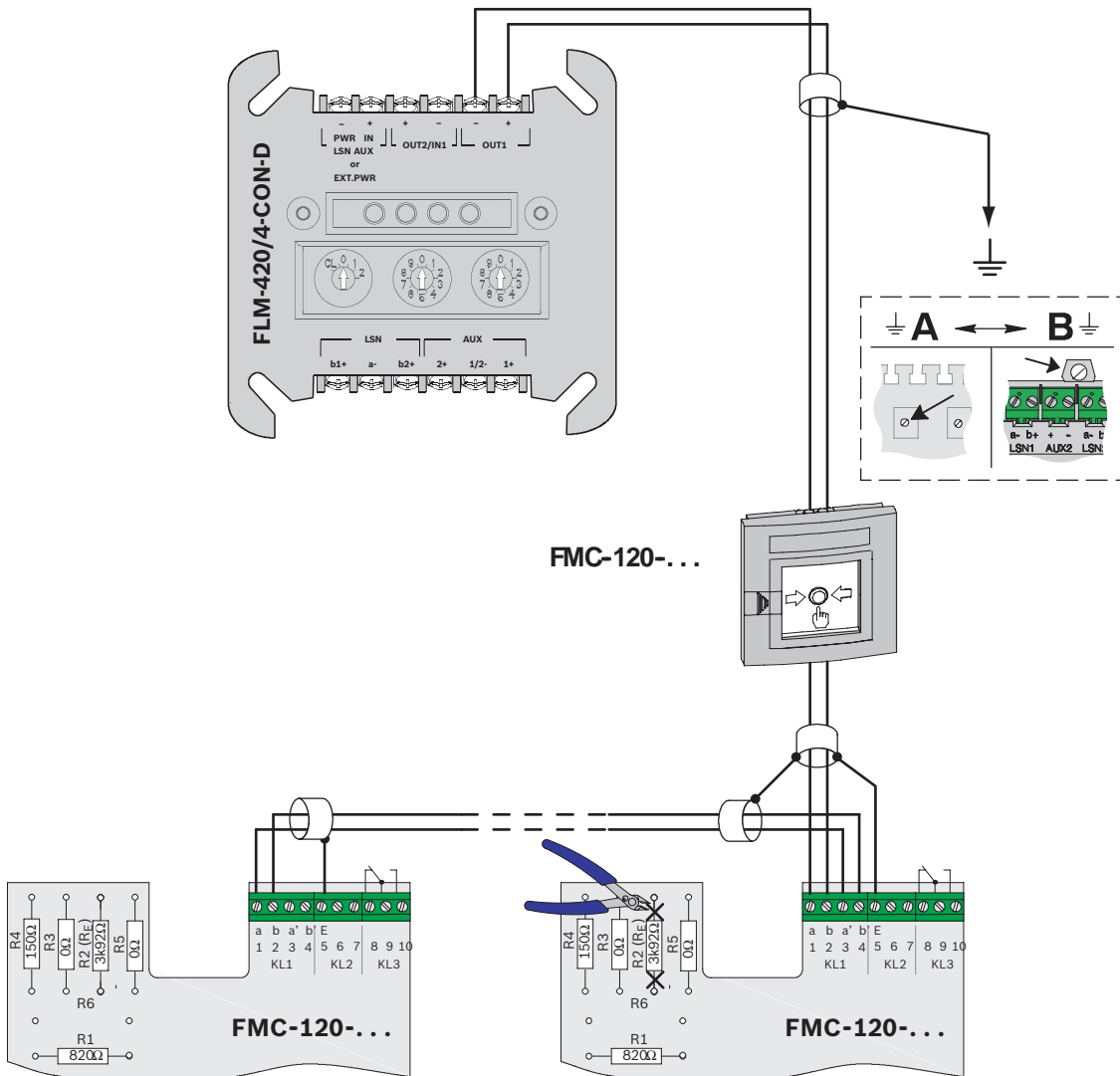
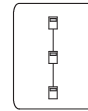

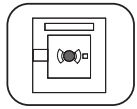

NO

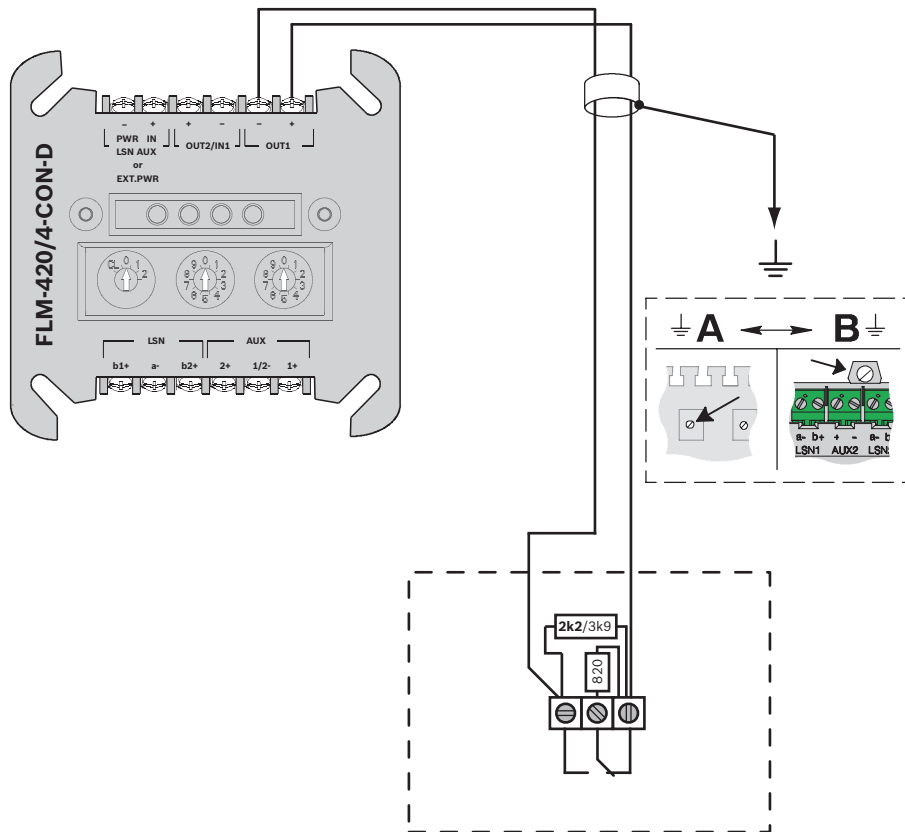
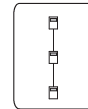

2.5.2

FLM-420-I8R1-S

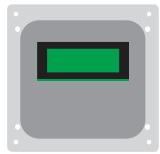

ProReact EN Analogue

FCS-LHD-2EN

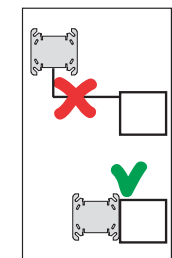
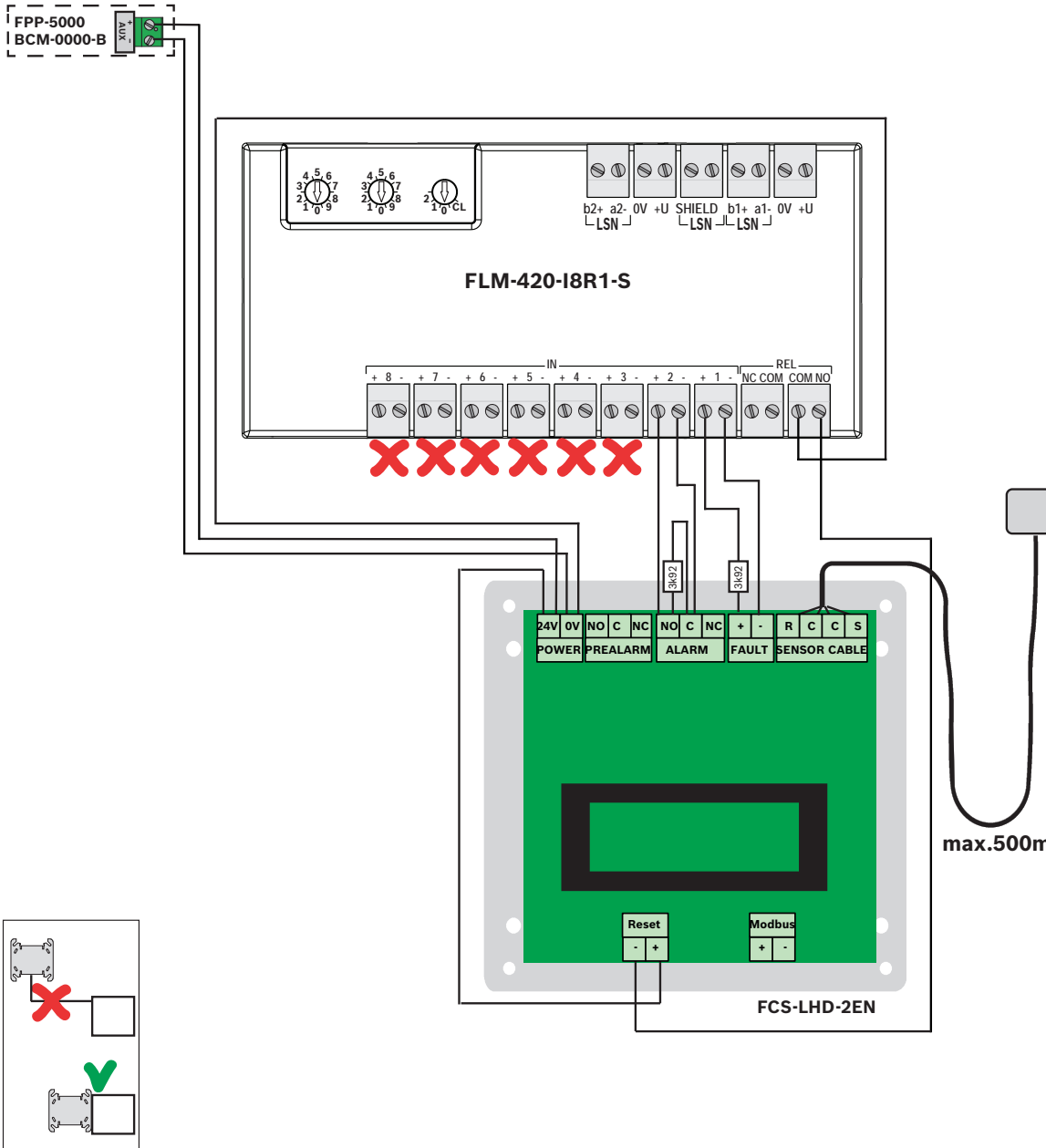

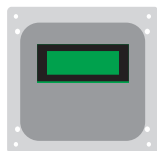

ProReact EN Analogue

FCS-LHD-2EN



ELS

FPP-3000(ZSP135-DR)  
FPP-5000  
BCM-0000-B

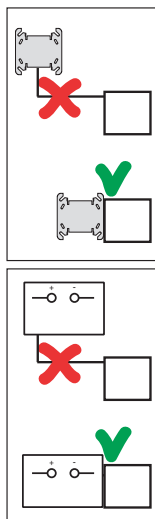
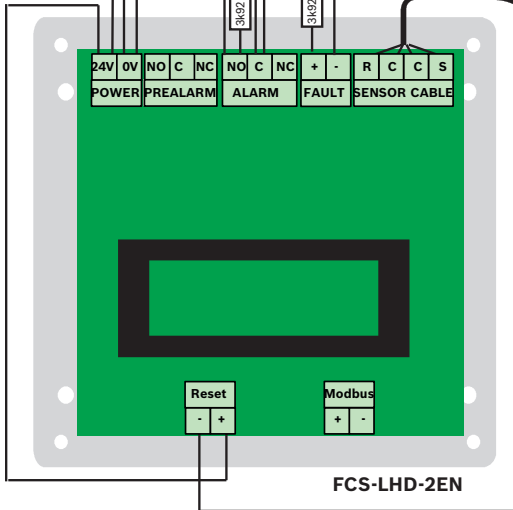
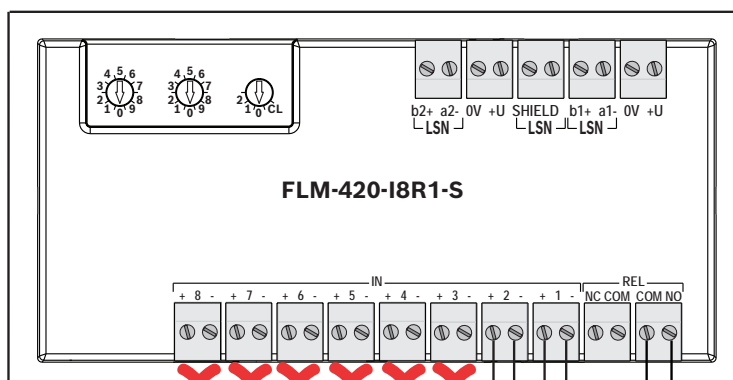

### 2.5.3 FLM-420-NAC-D/S

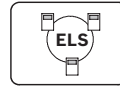

FPP-3000(ZSP135-DR)  
 FPP-5000  
 BCM-0000-B

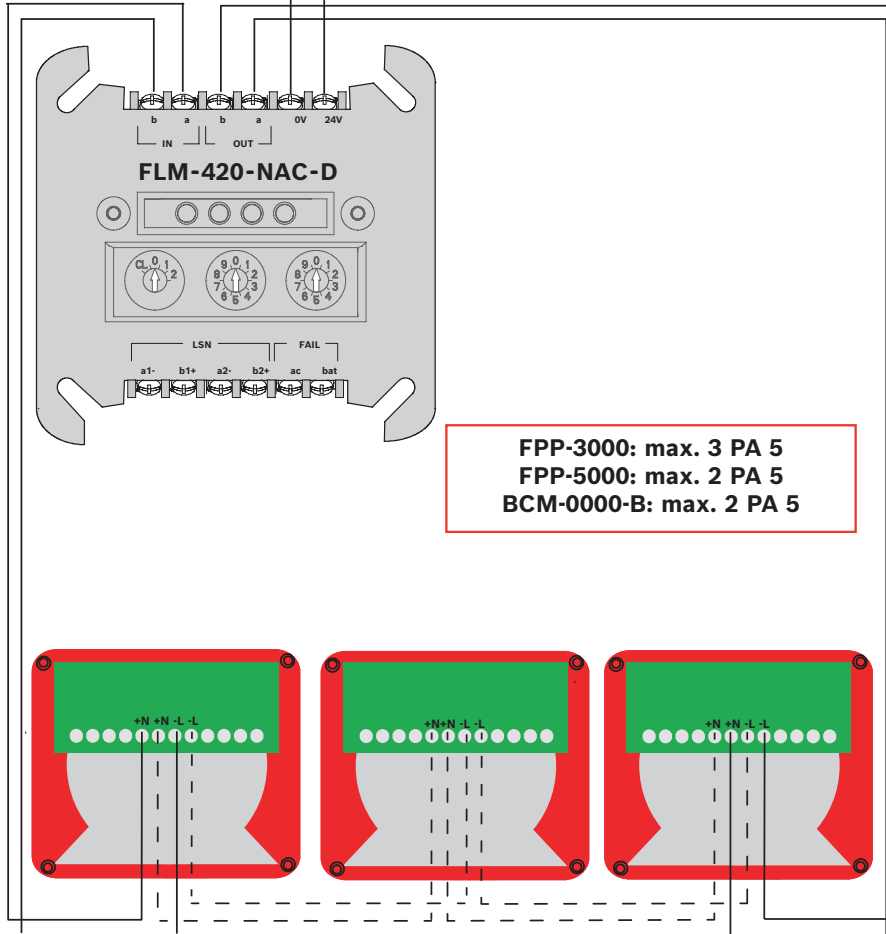

**FPP-3000: max. 3 PA 5**  
**FPP-5000: max. 2 PA 5**  
**BCM-0000-B: max. 2 PA 5**

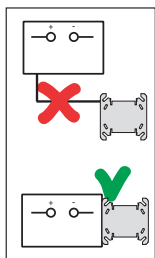





FPP-3000  
FPP-5000  
BCM-0000-B

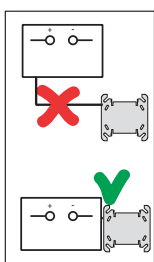
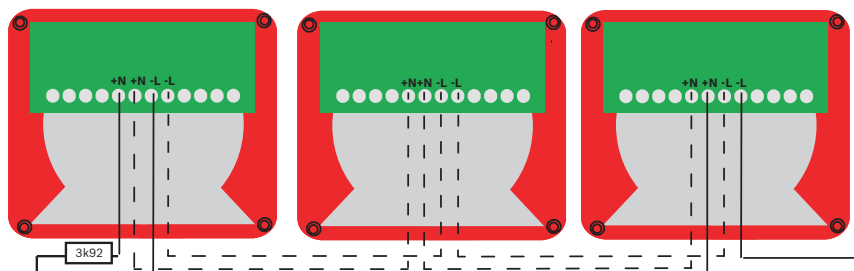
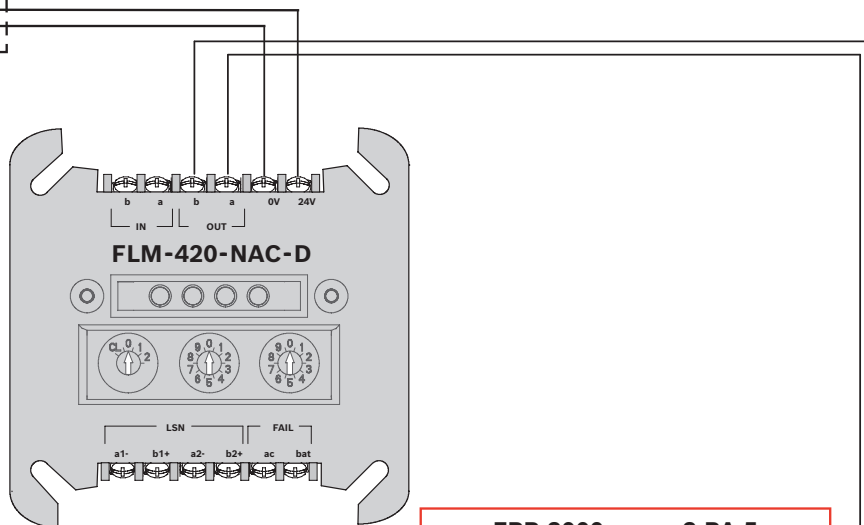

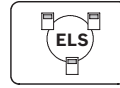

FPP-3000(ZSP135-DR)  
 FPP-5000  
 BCM-0000-B

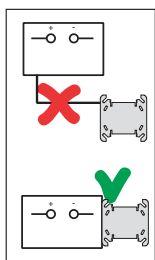
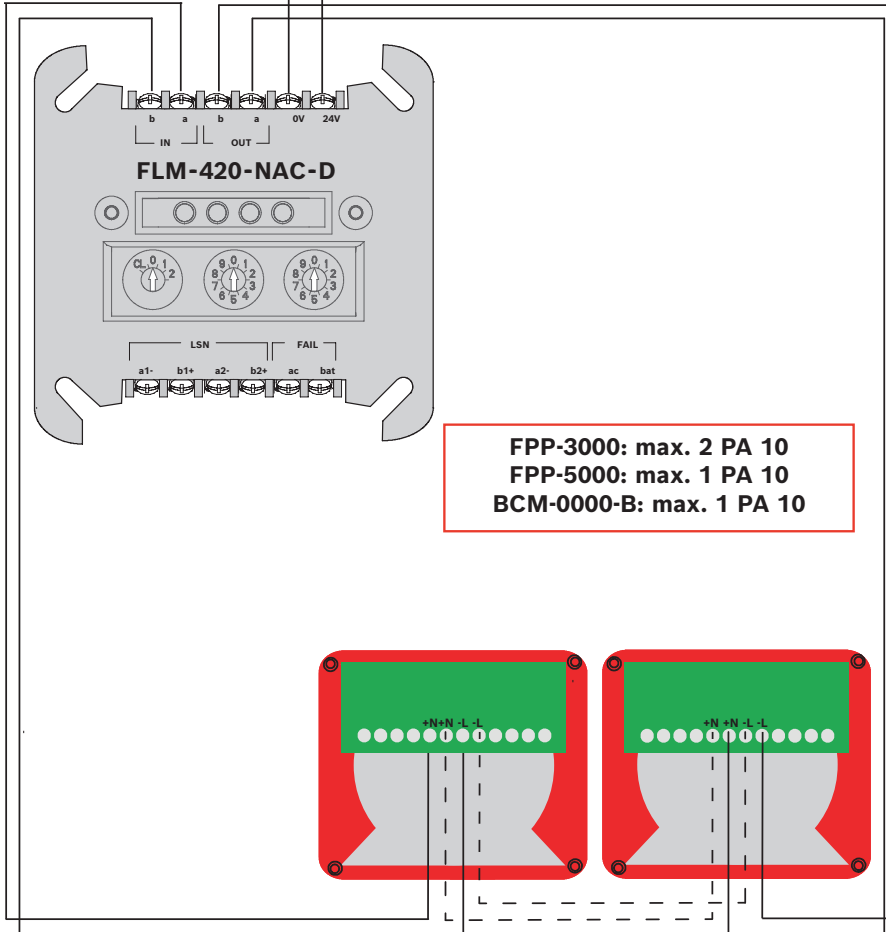



FPP-3000  
FPP-5000  
BCM-0000-B

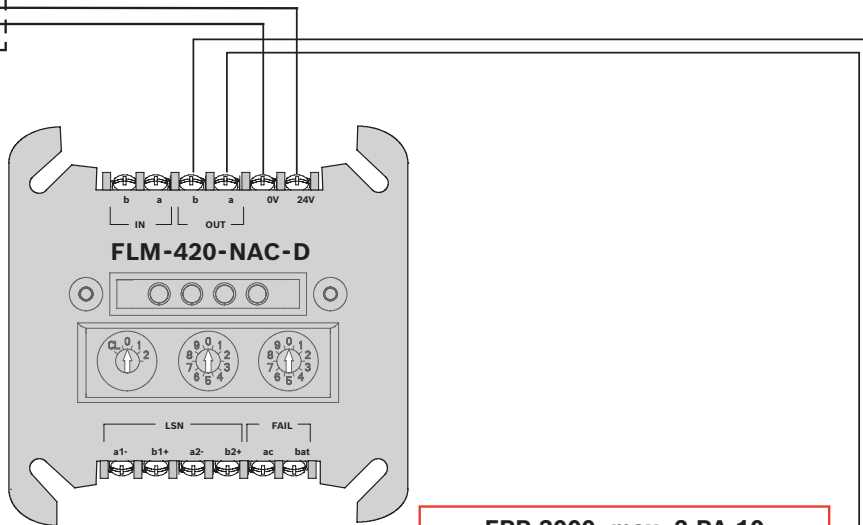

**FPP-3000: max. 2 PA 10**  
**FPP-5000: max. 1 PA 10**  
**BCM-0000-B: max. 1 PA 10**

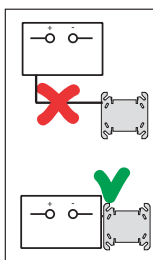
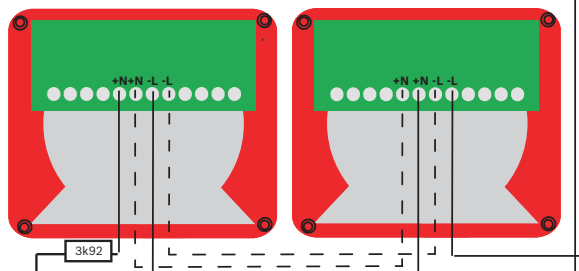

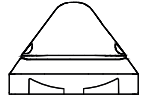

**PY X-M-10-SSM R**  
**PY X-M-10-SSM W**

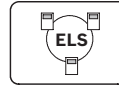

FPP-3000(ZSP-135-DR)  
FPP-5000  
BCM-0000-B

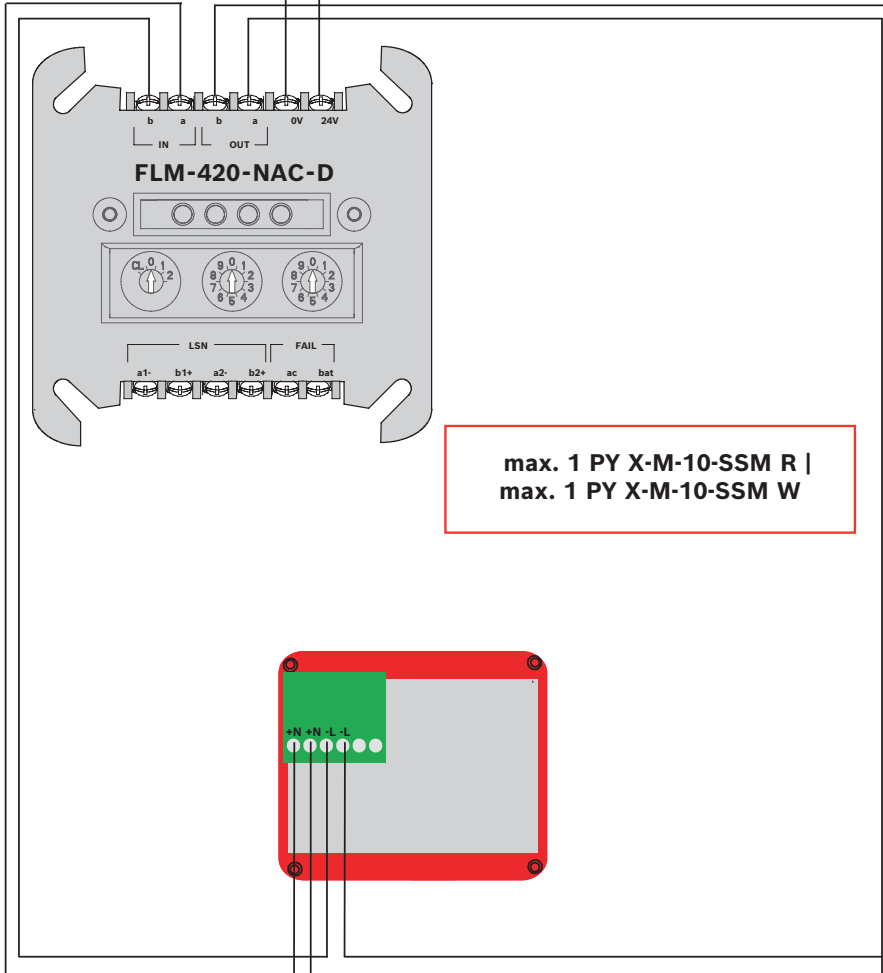

**max. 1 PY X-M-10-SSM R |**  
**max. 1 PY X-M-10-SSM W**

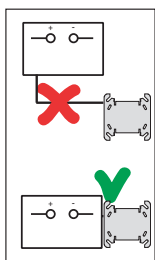

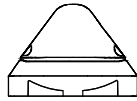

**PY X-M-10-SSM R**  
**PY X-M-10-SSM W**



FPP-3000  
 FPP-5000  
 BCM-0000-B

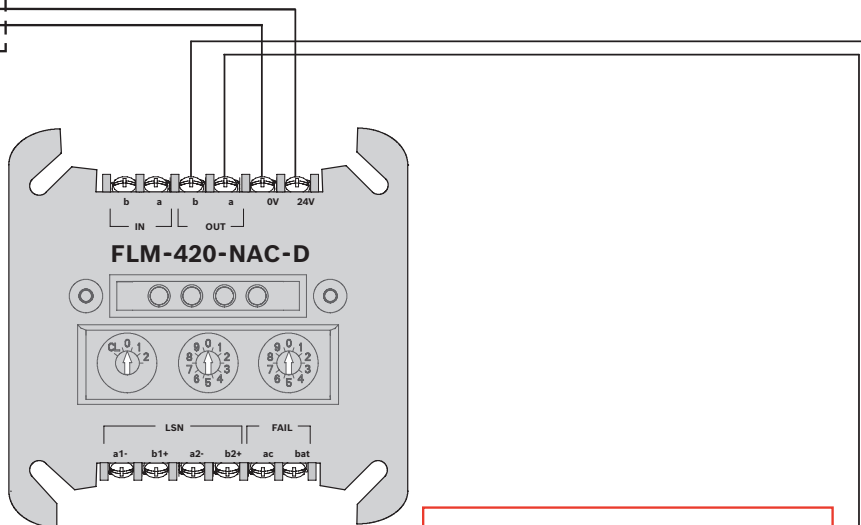

**max. 1 PY X-M-10-SSM R |**  
**max. 1 PY X-M-10-SSM W**

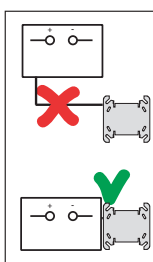
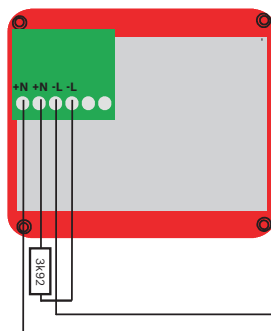



PB 2005

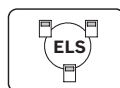

FPP-5000  
BCM-0000-B

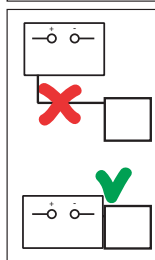
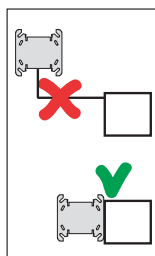
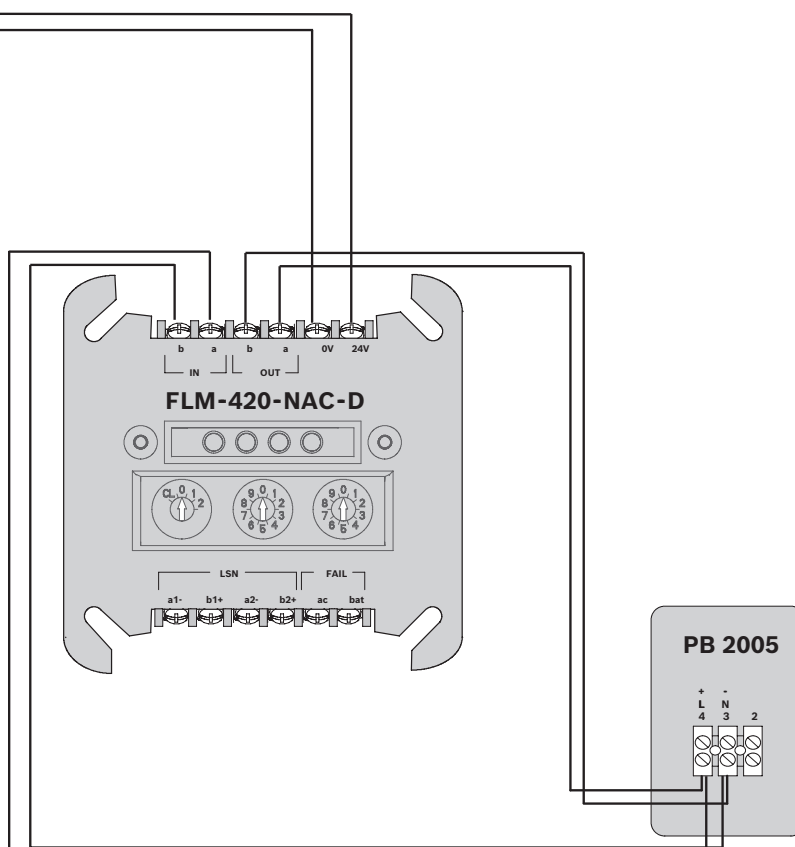



PB 2005

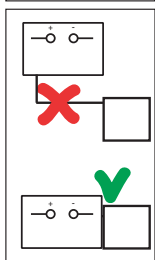
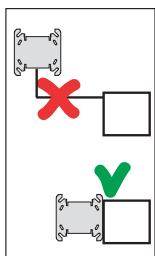
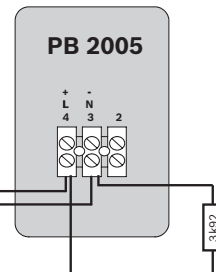
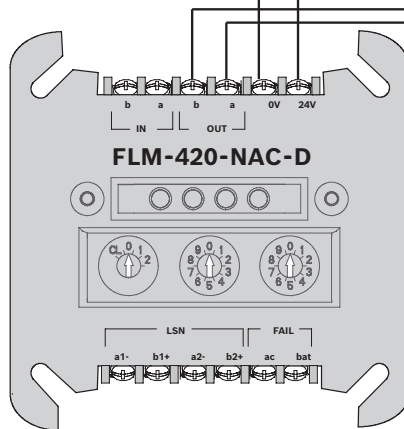

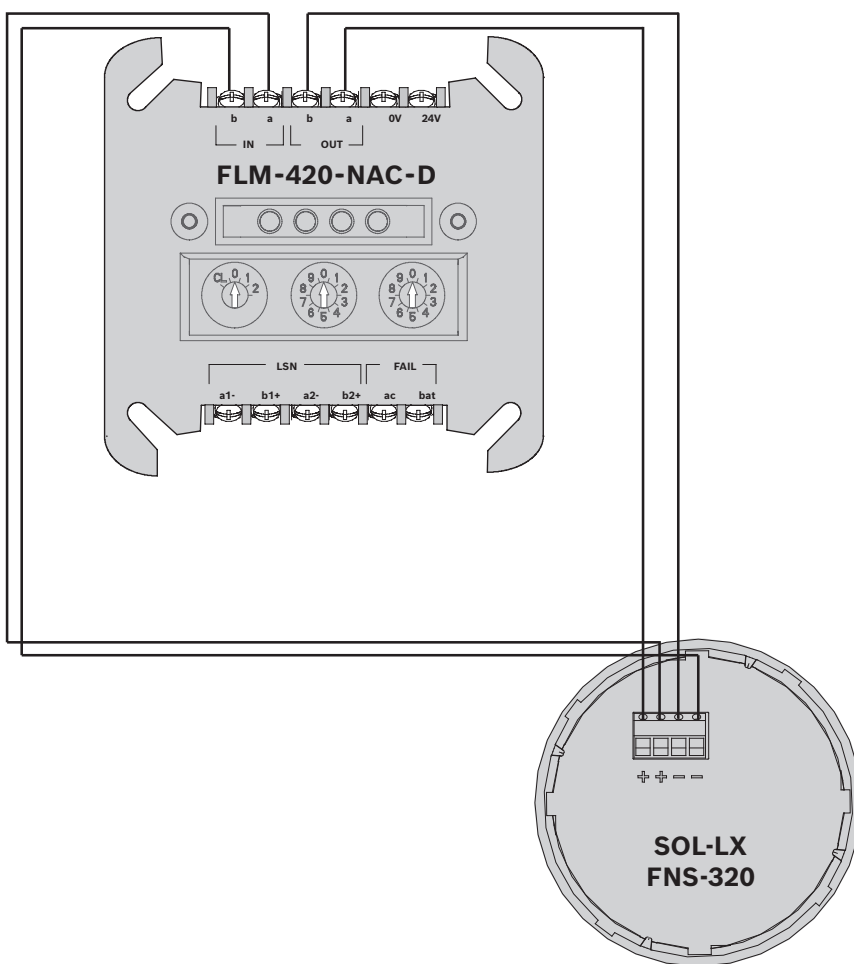
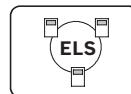



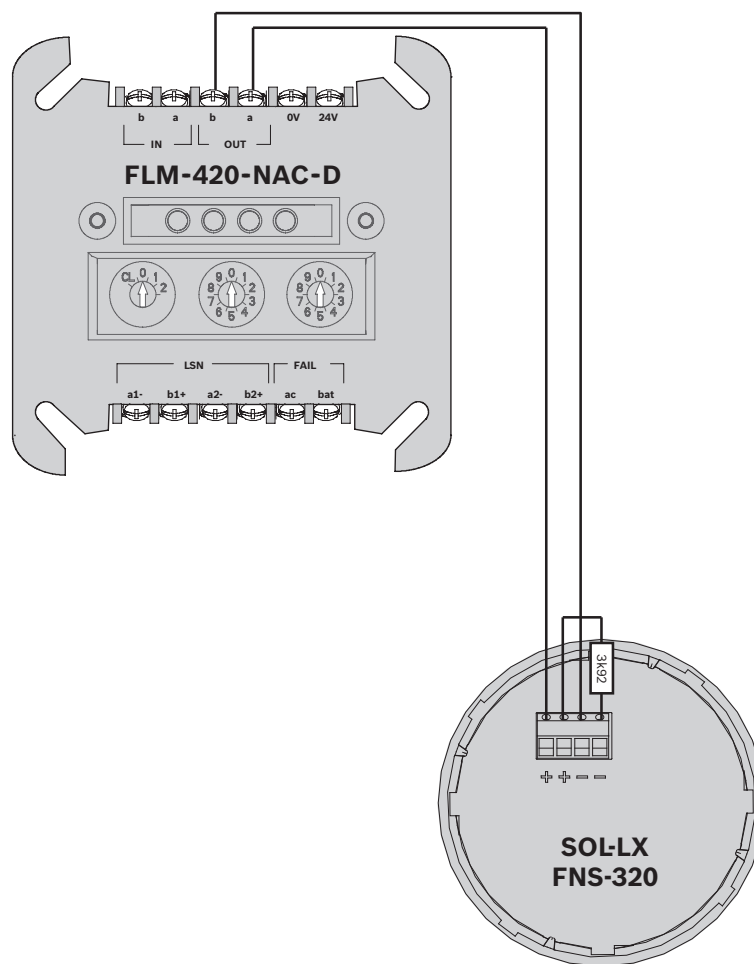
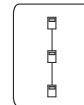

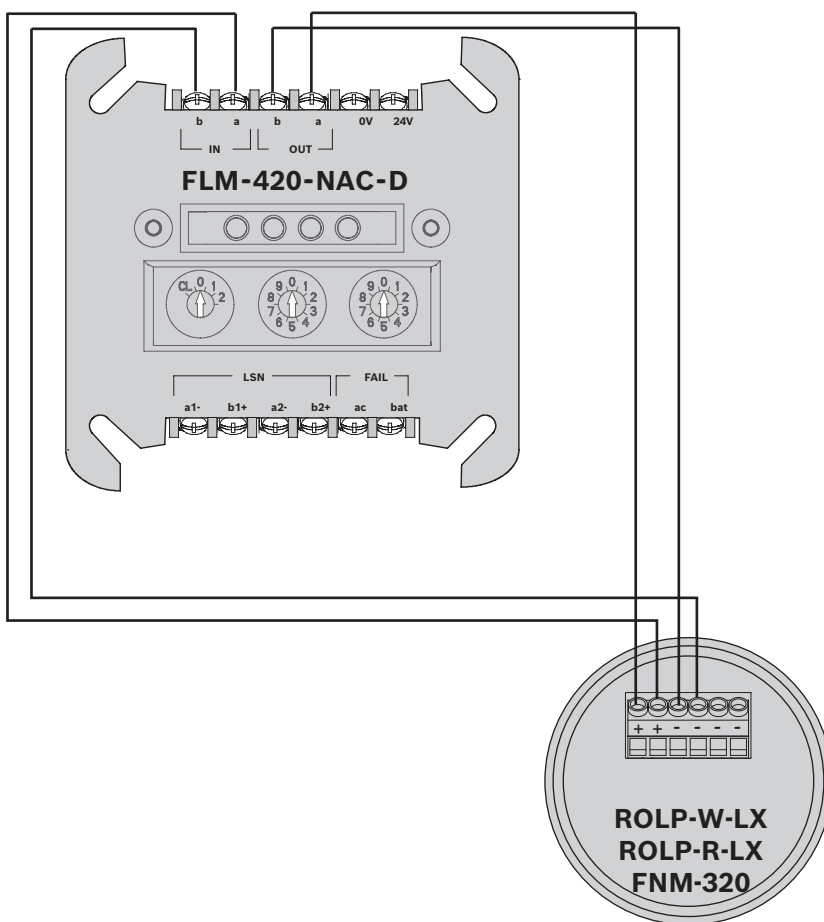
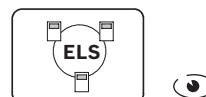



**ROLP-W-LX**  
**ROLP-R-LX**  
**FNM-320**

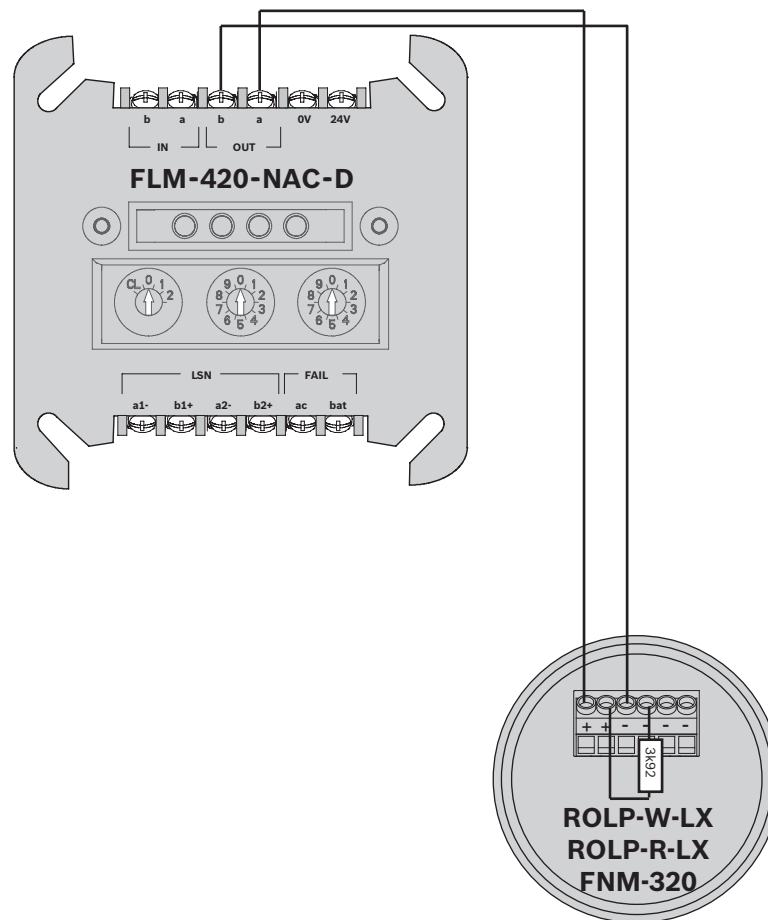
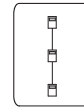

### 2.5.4 FLM-420-RHV

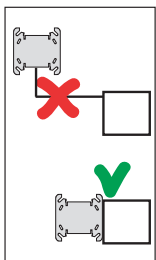
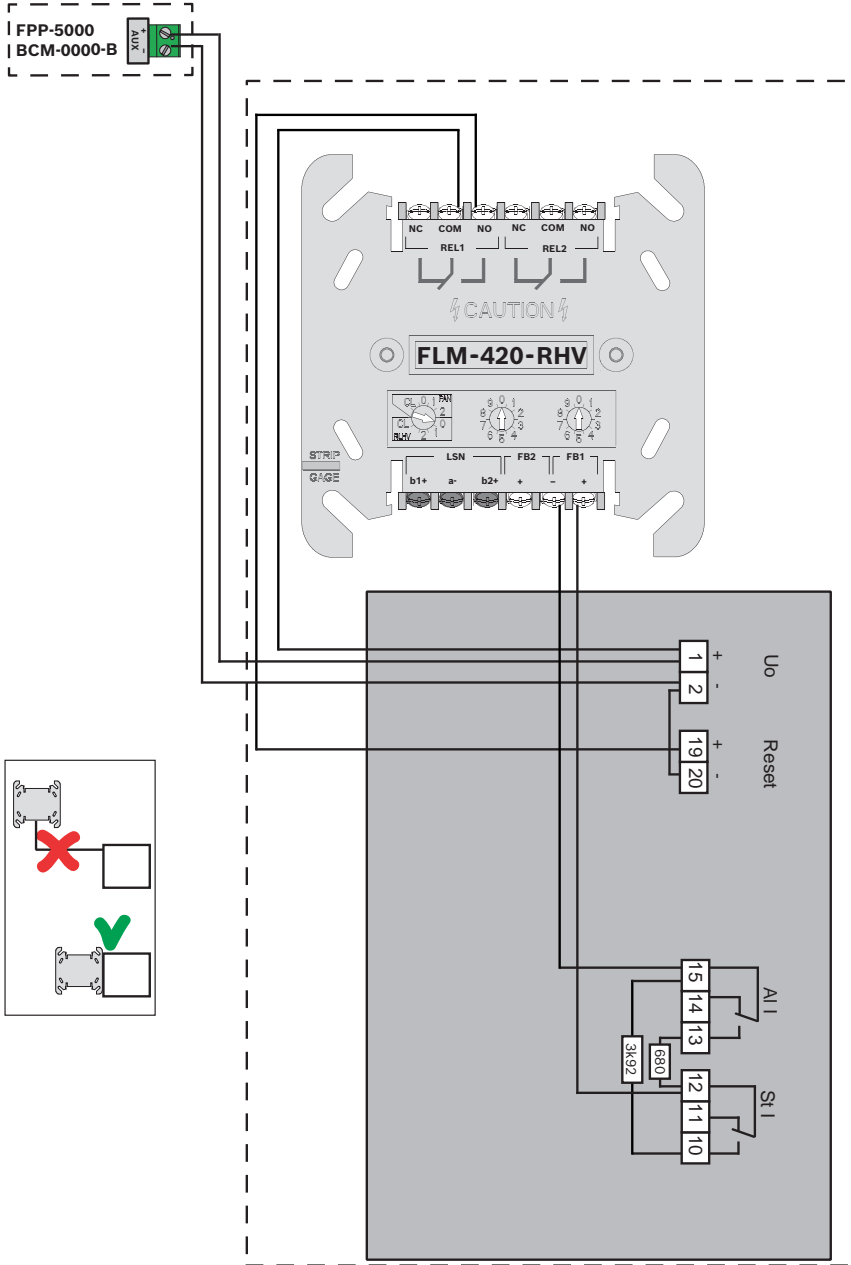



ELS

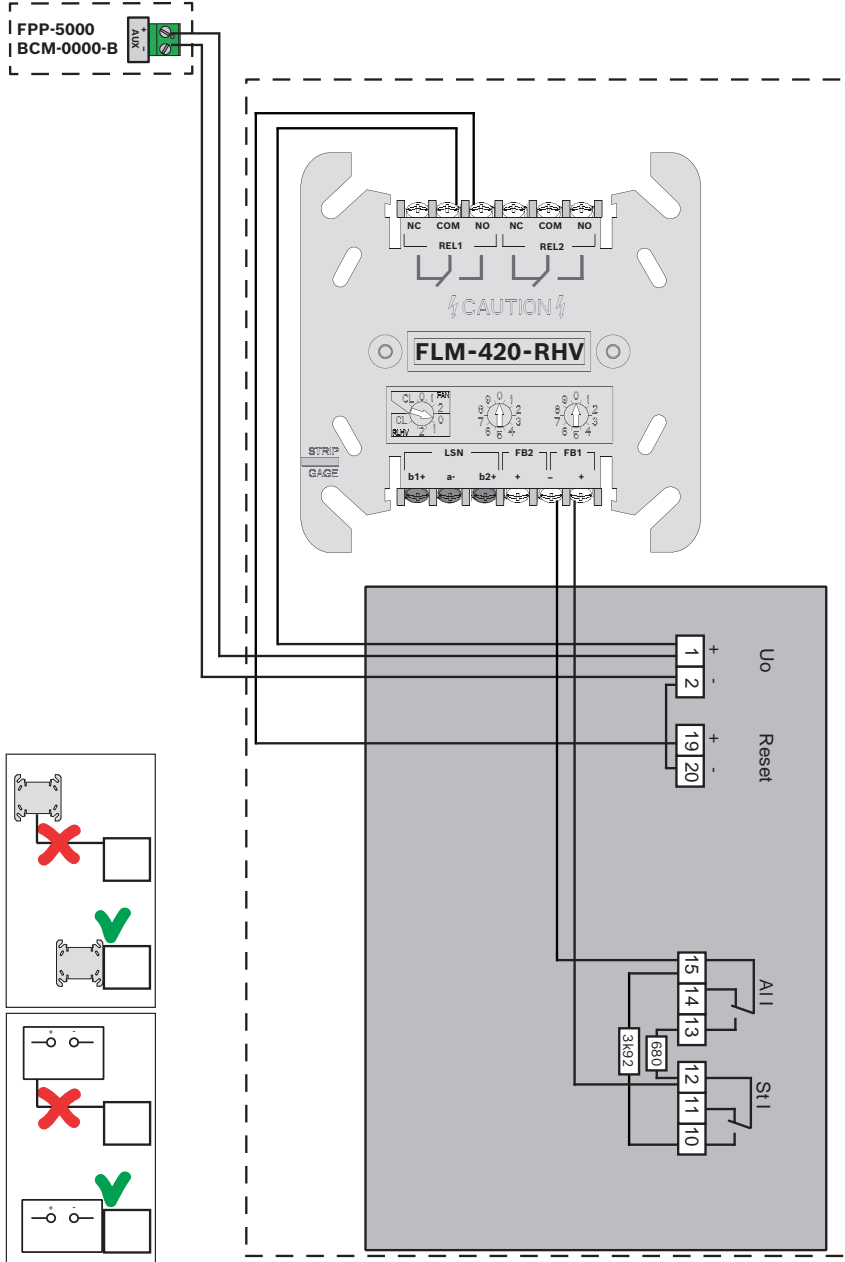

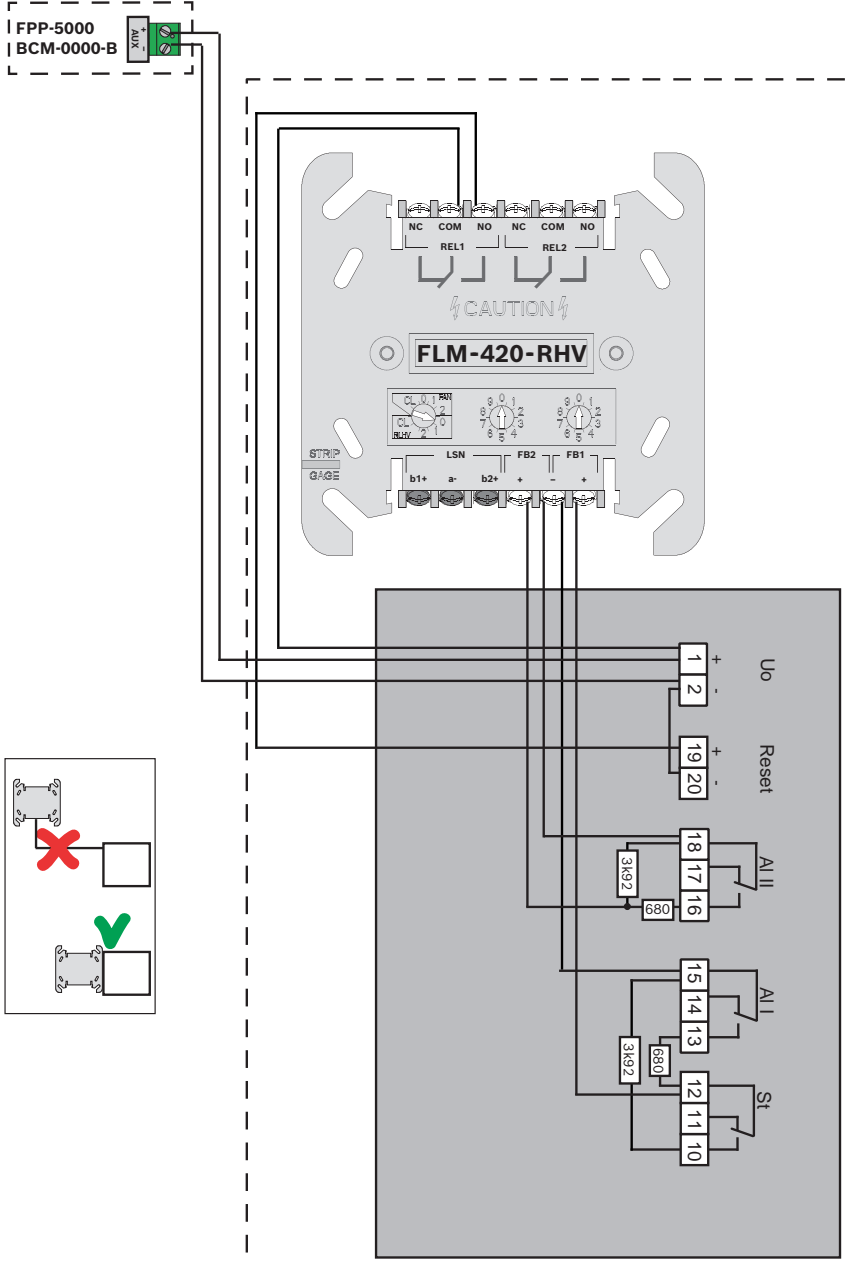
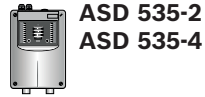



ELS

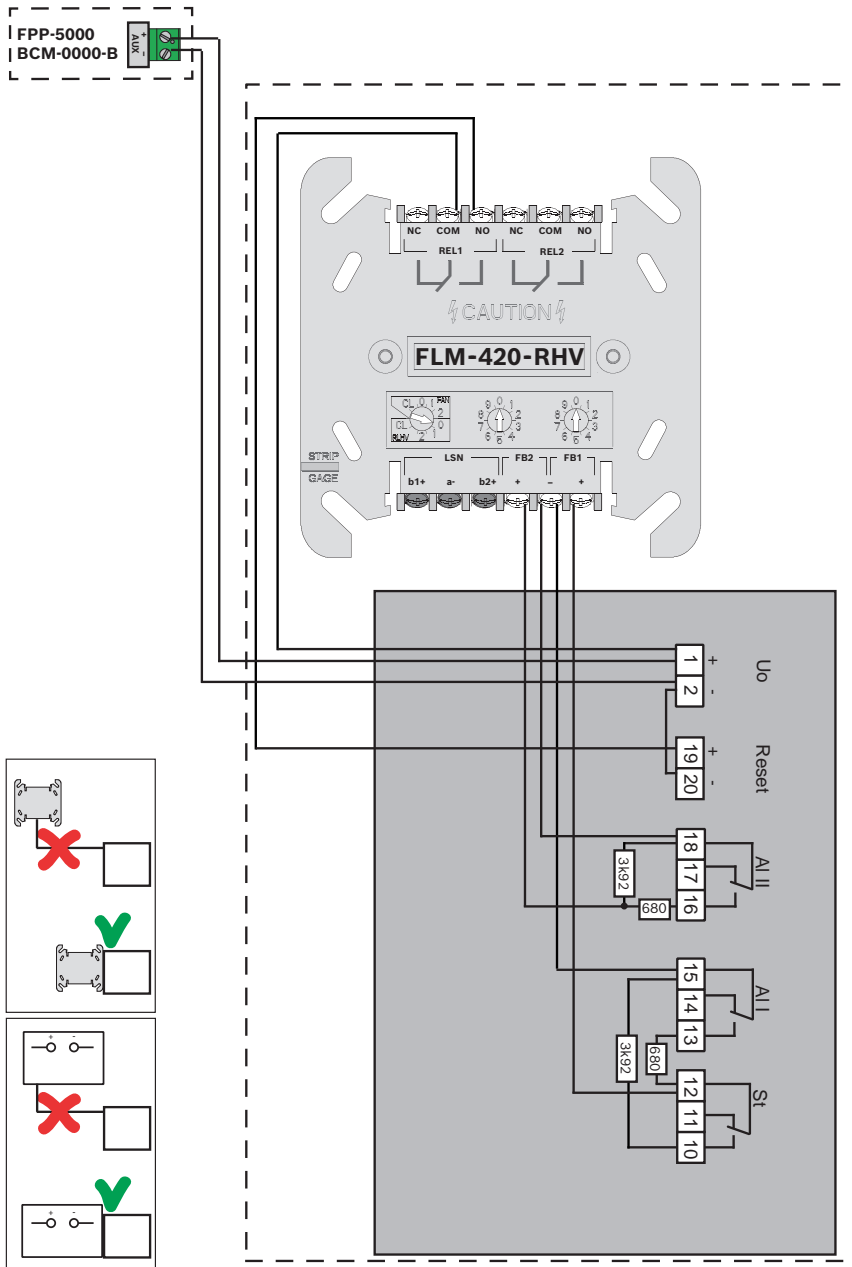

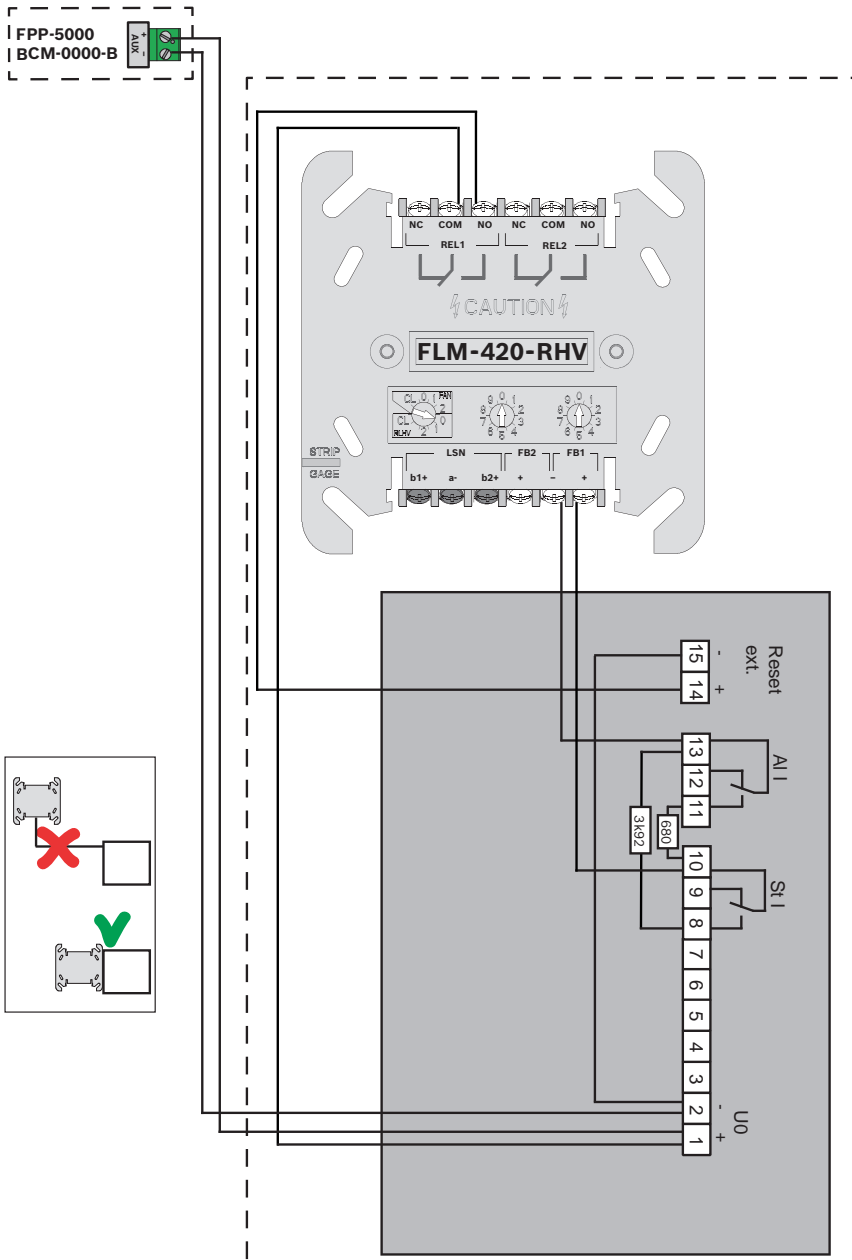



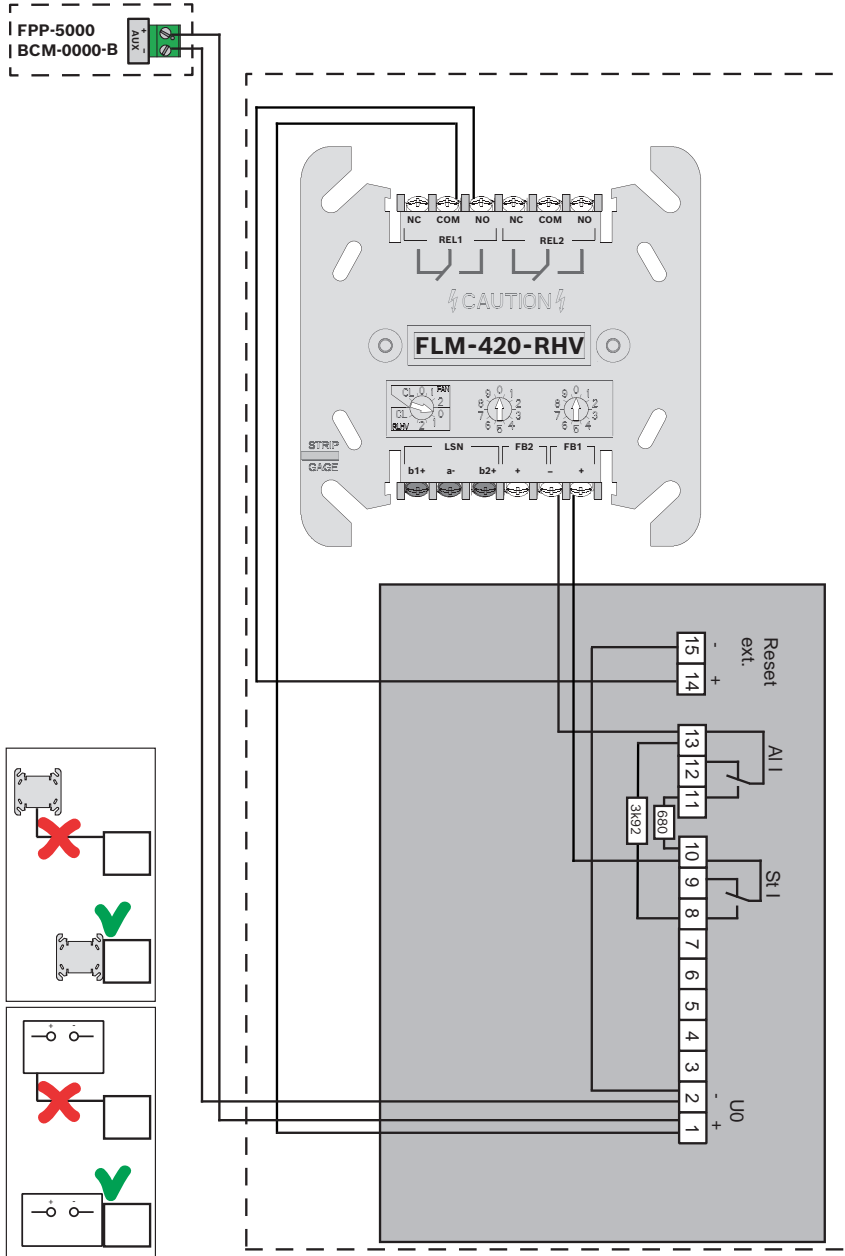



ADW 535-1

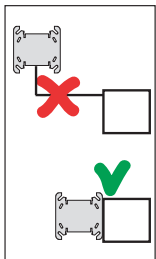
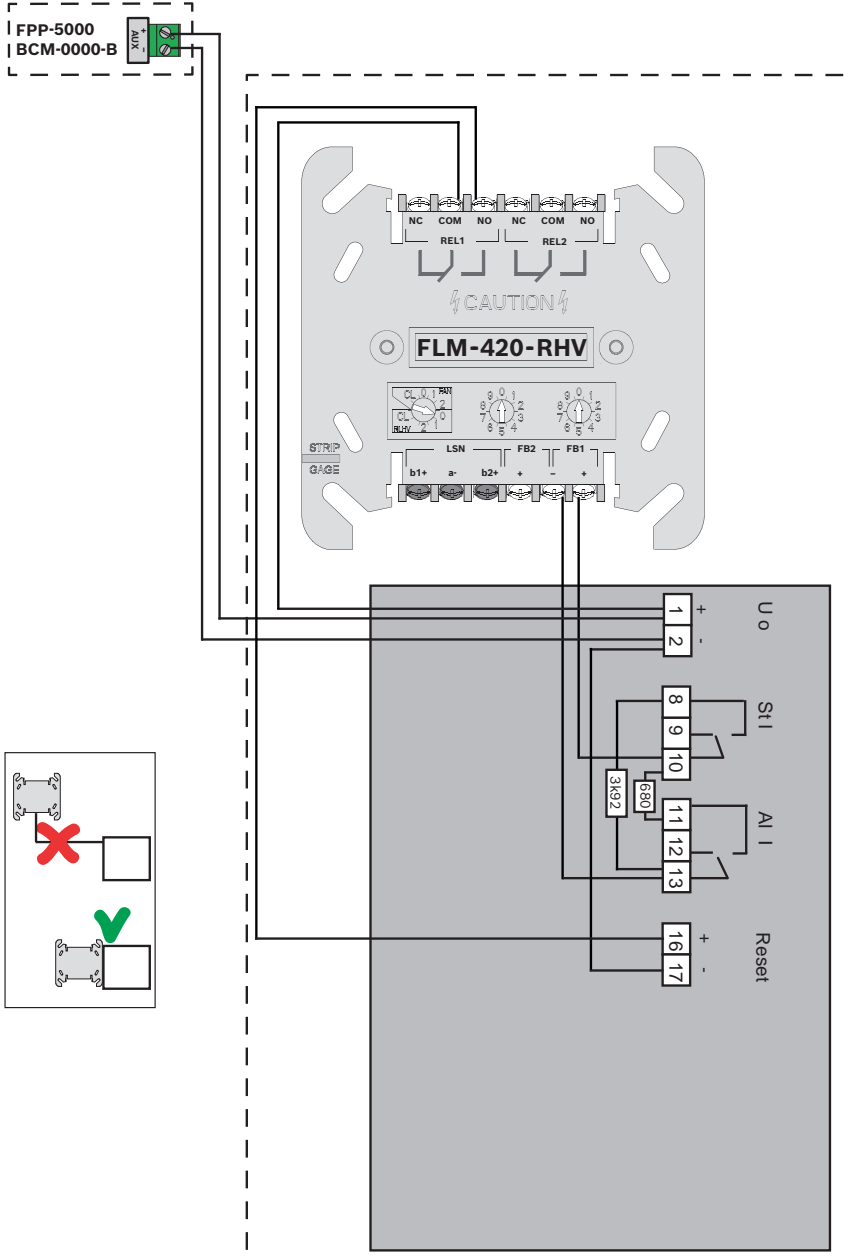



ADW 535-1



ELS

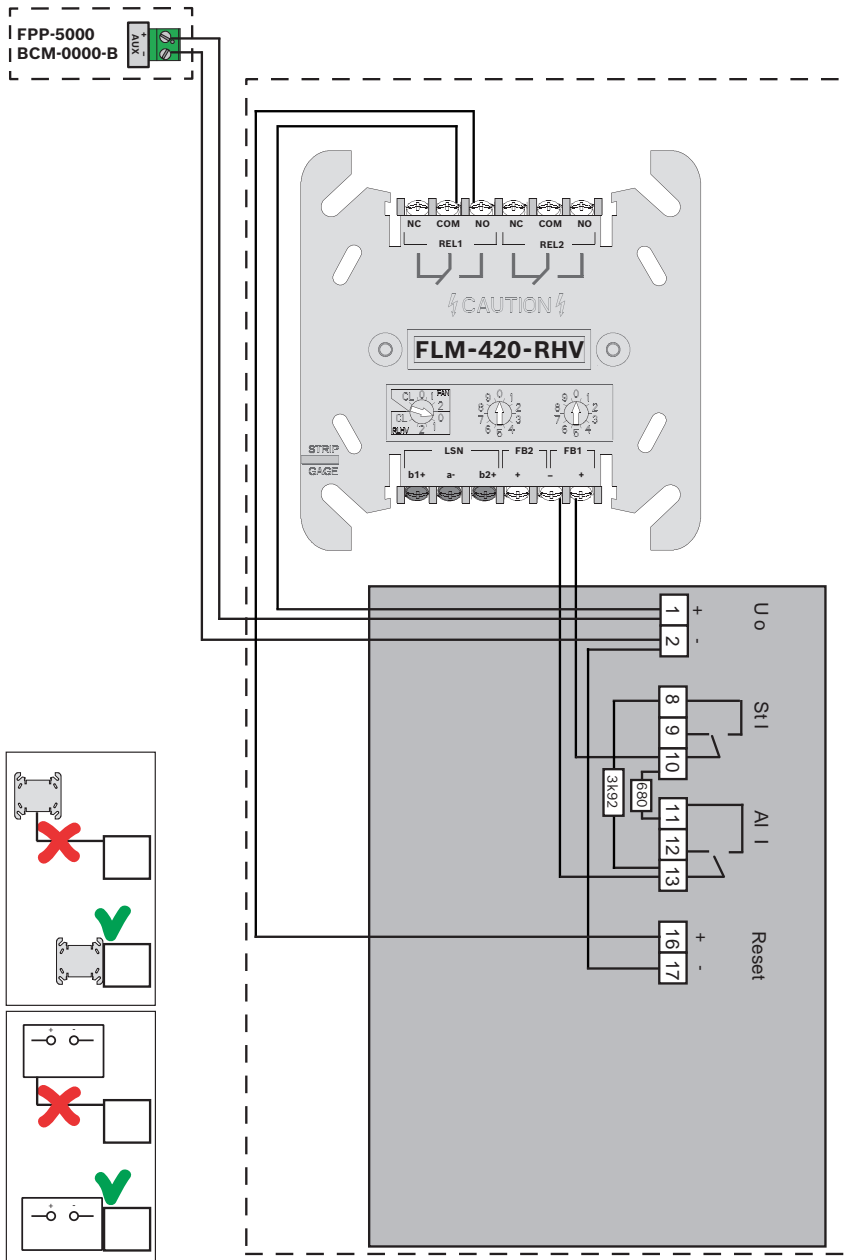



ADW 535-2

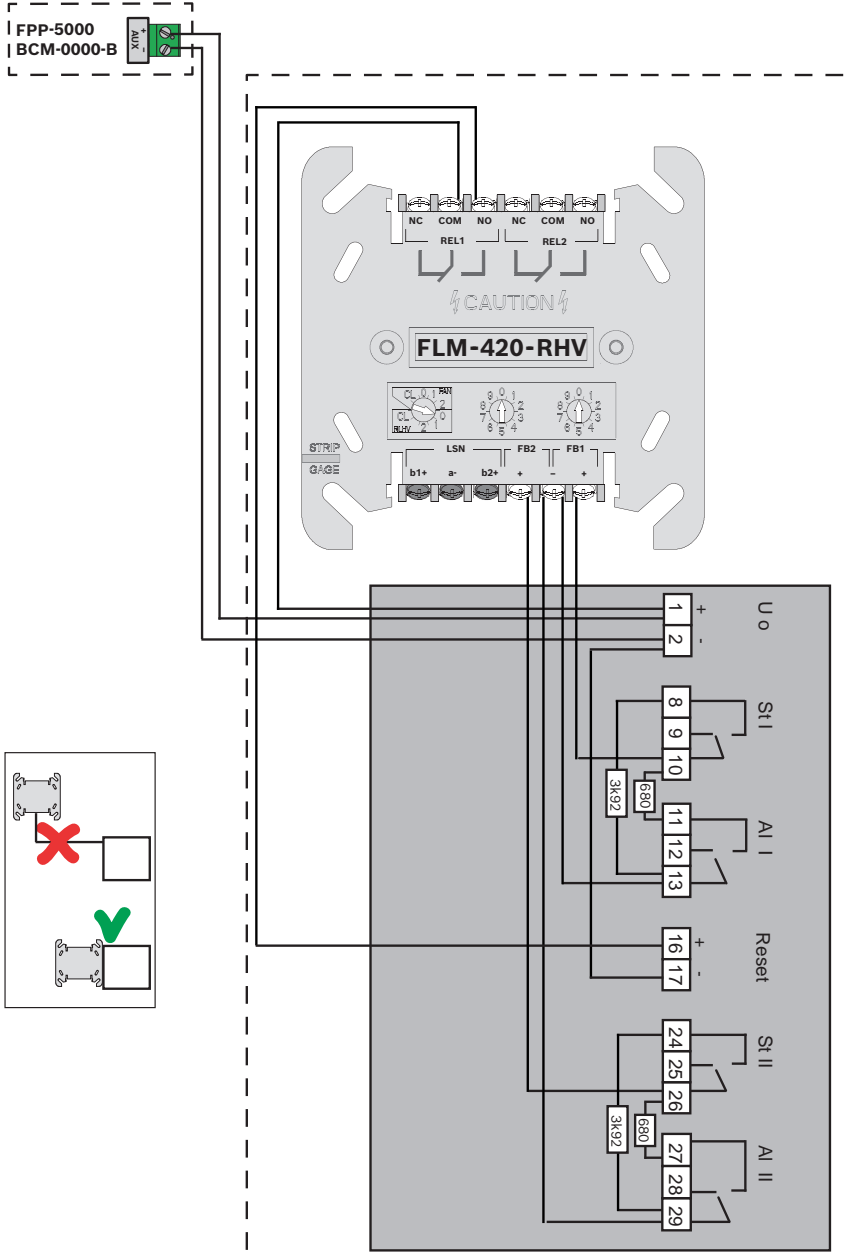



ADW 535-2



ELS

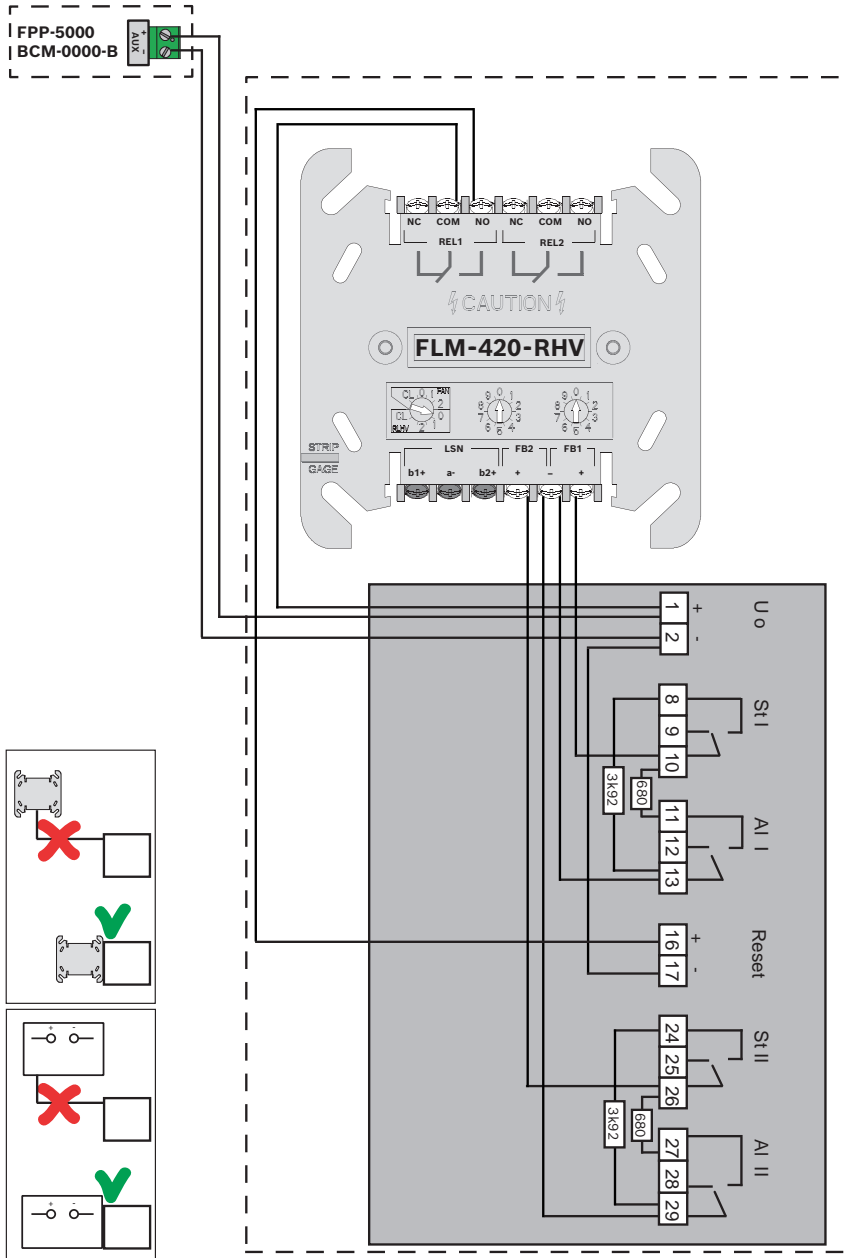



Fireray One

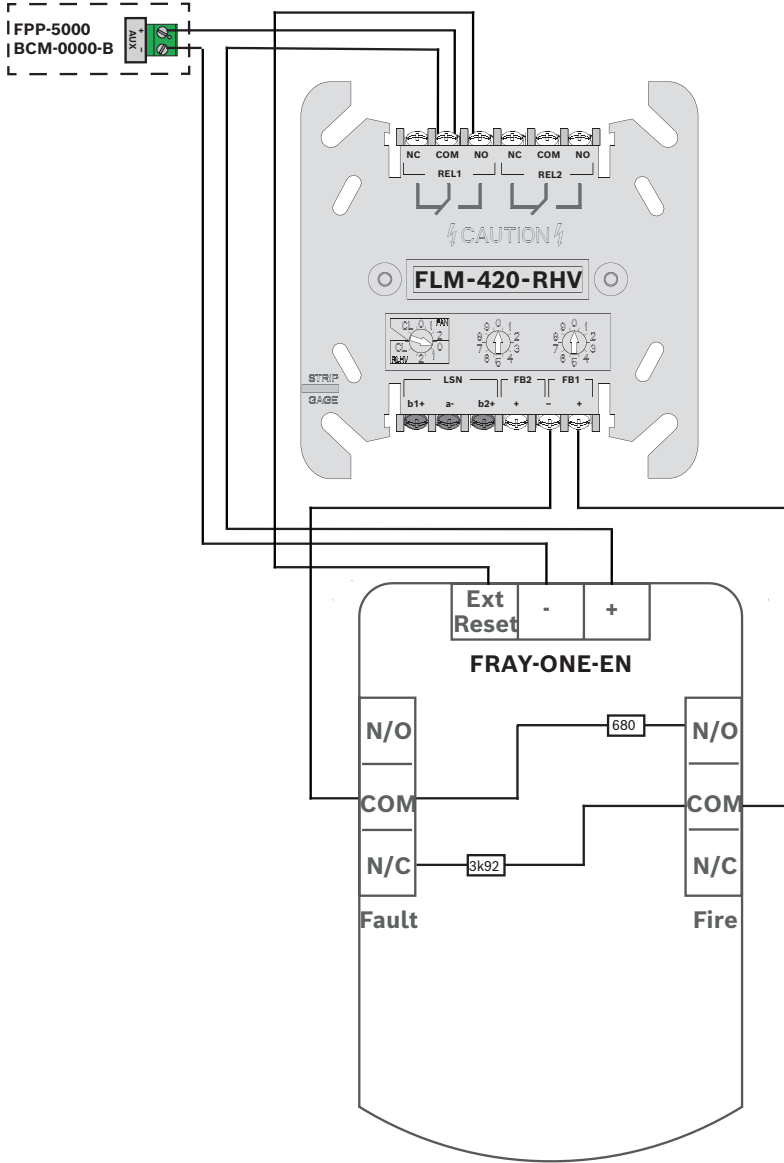



Fireray One



ELS

FPP-5000  
BCM-0000-B

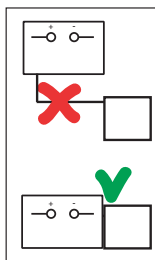
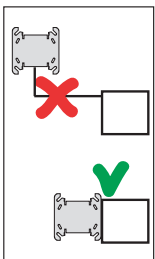
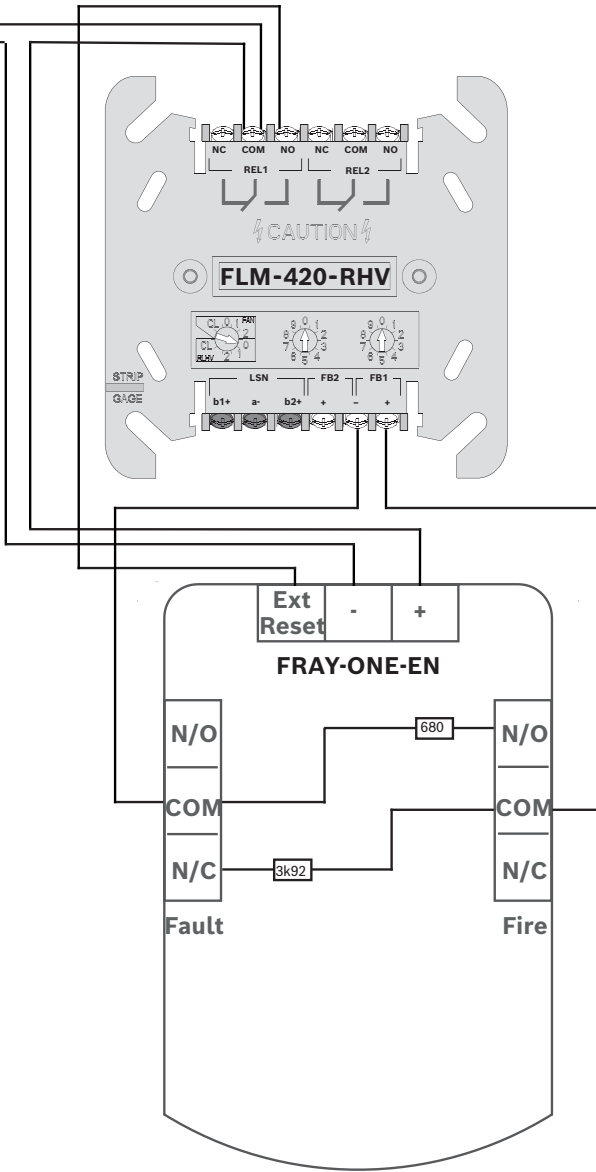

2.5.5

FLM-420-RLE-S



VdS 2496

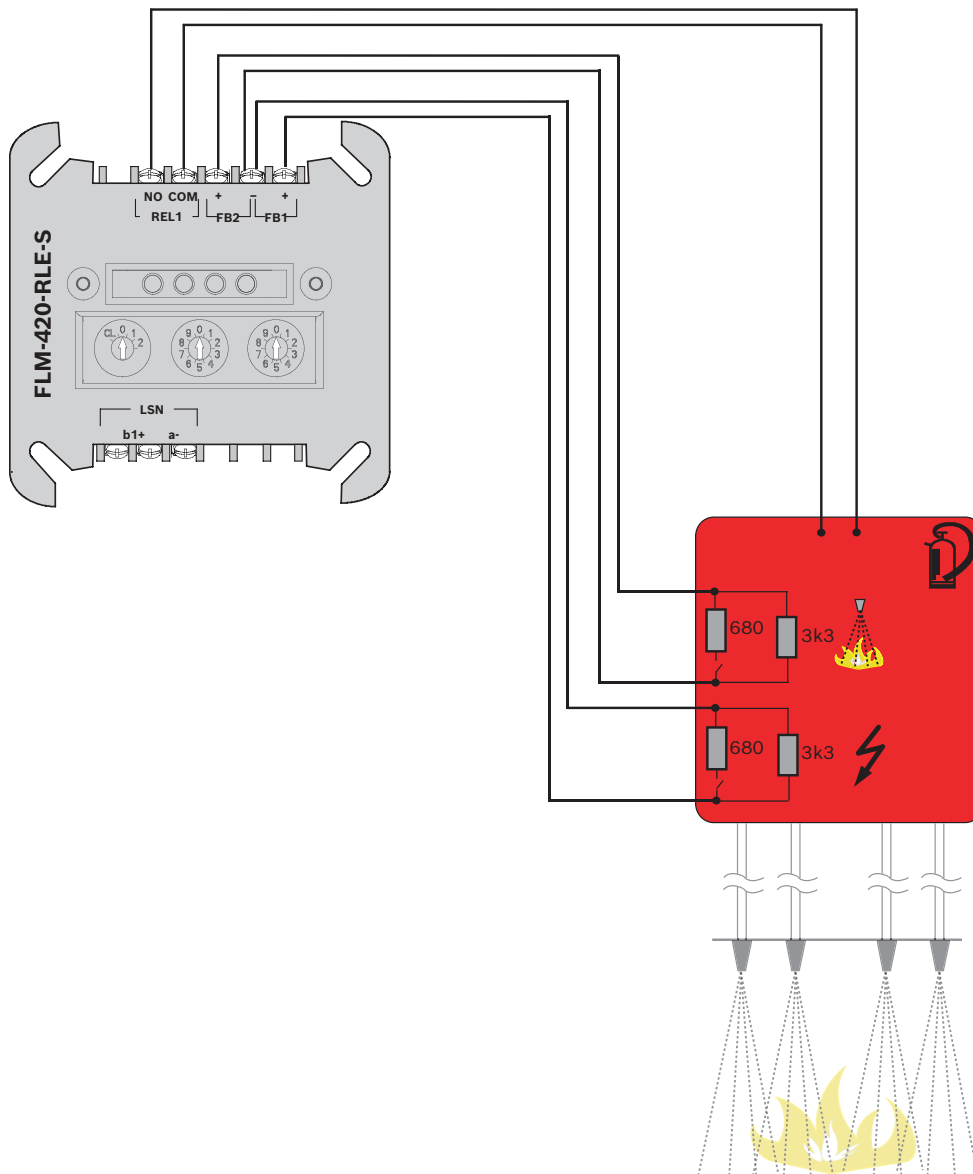



### 2.5.6 FLM-420-RLV1-E

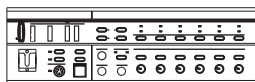
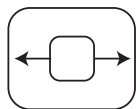

Plena

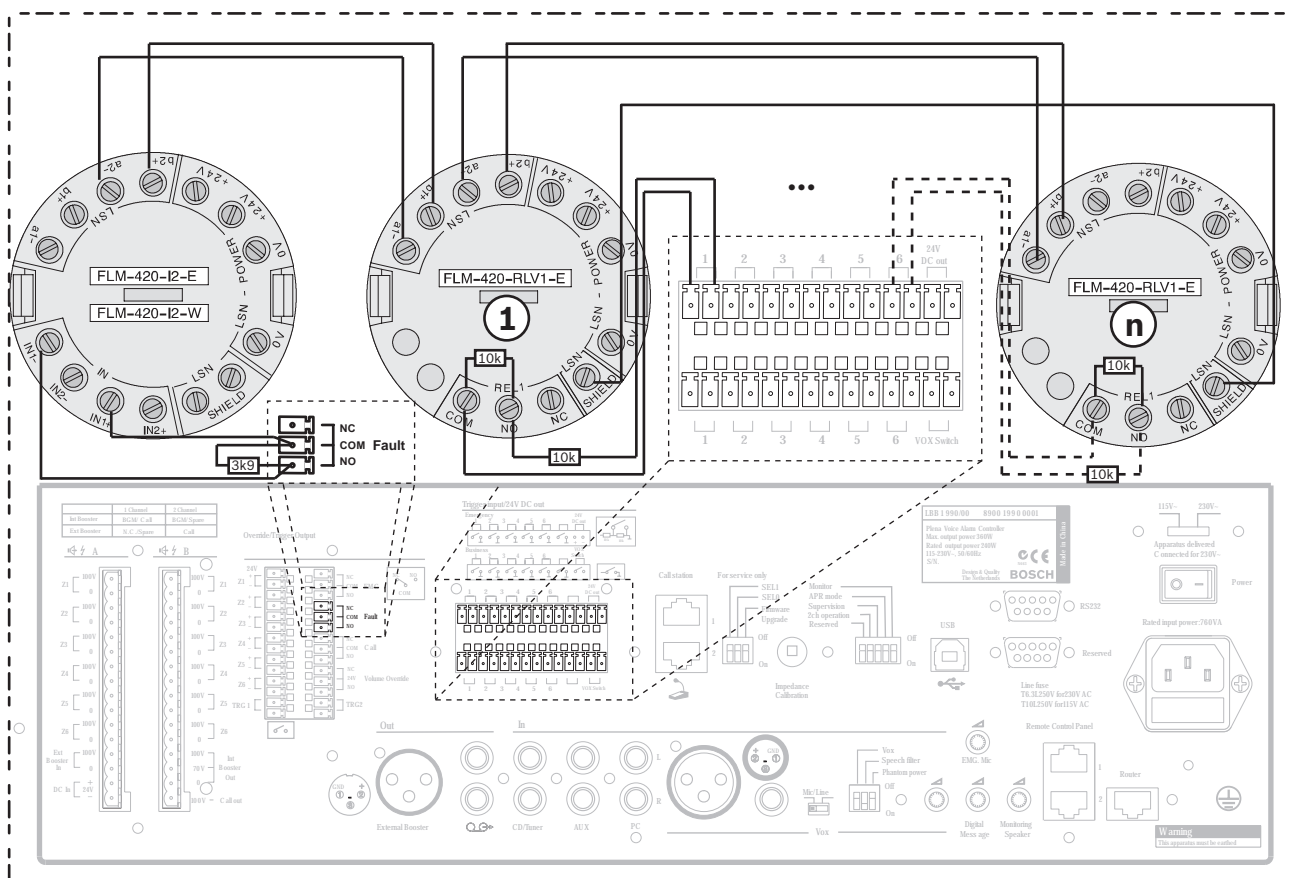

### 2.5.7 FLM-420-RLV8-S

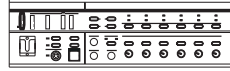
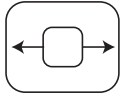

Plena

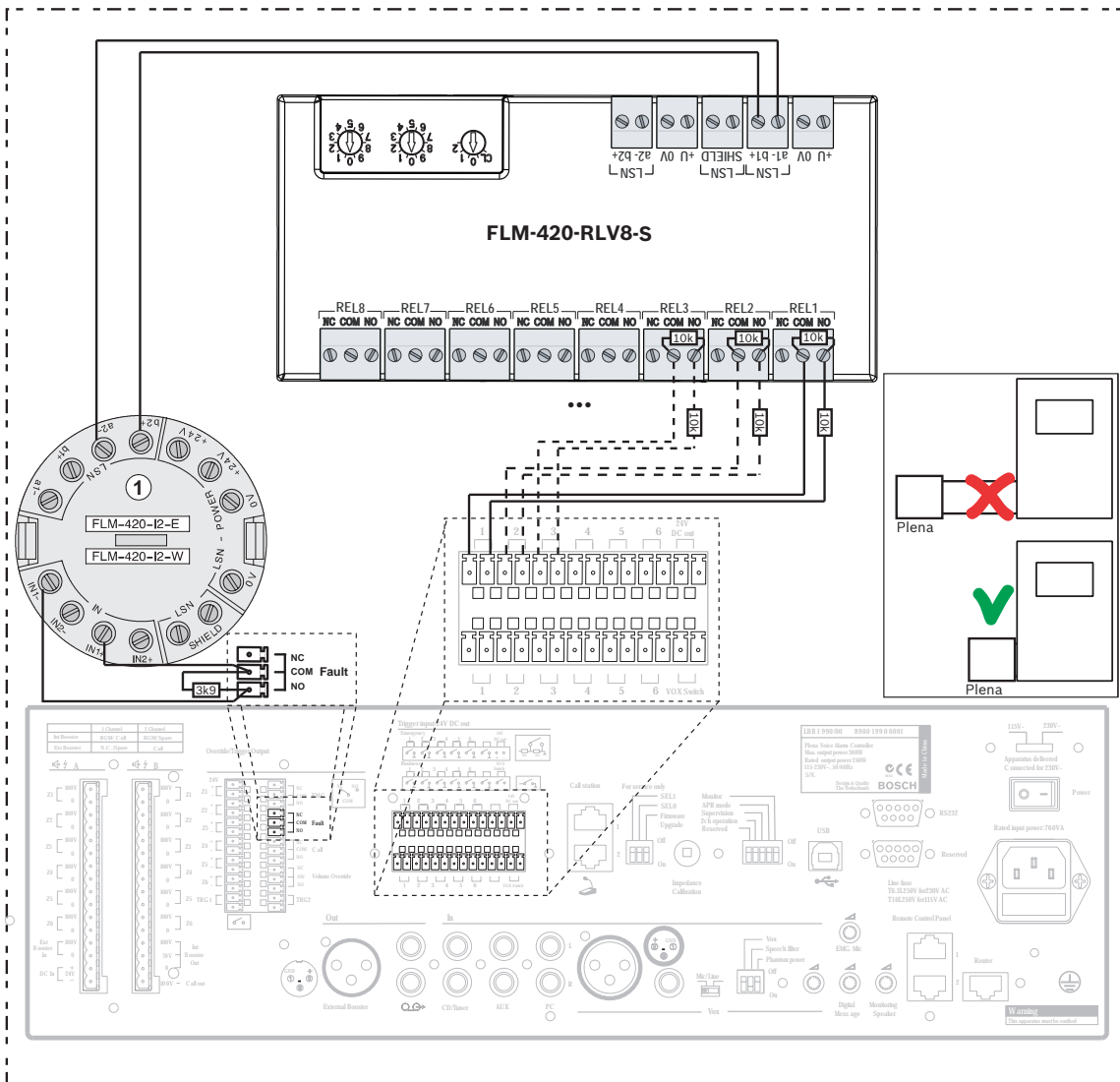
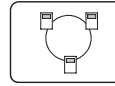

### 2.5.8 FMF-ADP-FBF/FMF-ADP-TTY



FAT4000 FBF4000 ADP4000  
 FMF-FAT FMF-FBF-FAT  
 FMF-FIBS-A4/-A3  
 FMF-ADP

ELS

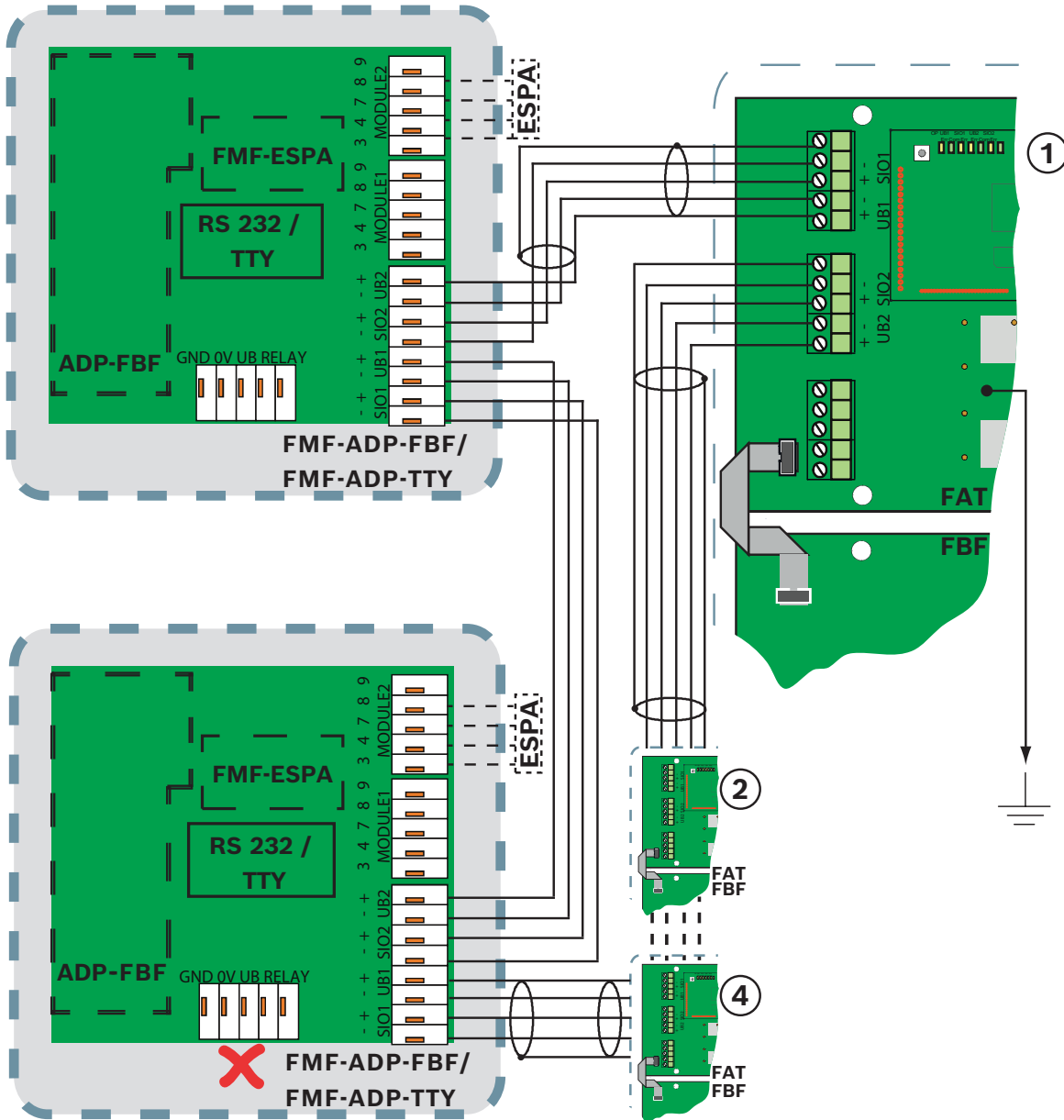

## 2.6

### EOL



*CZM 0004 A, Seite 189*

*LSN 0300 A, Seite 201*

*FLM-420/4-CON-S/D, Seite 246*

2.6.1

CZM 0004 A

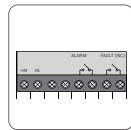
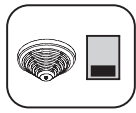

016519, 016589  
IR3 Flame Detector

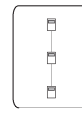

ELS

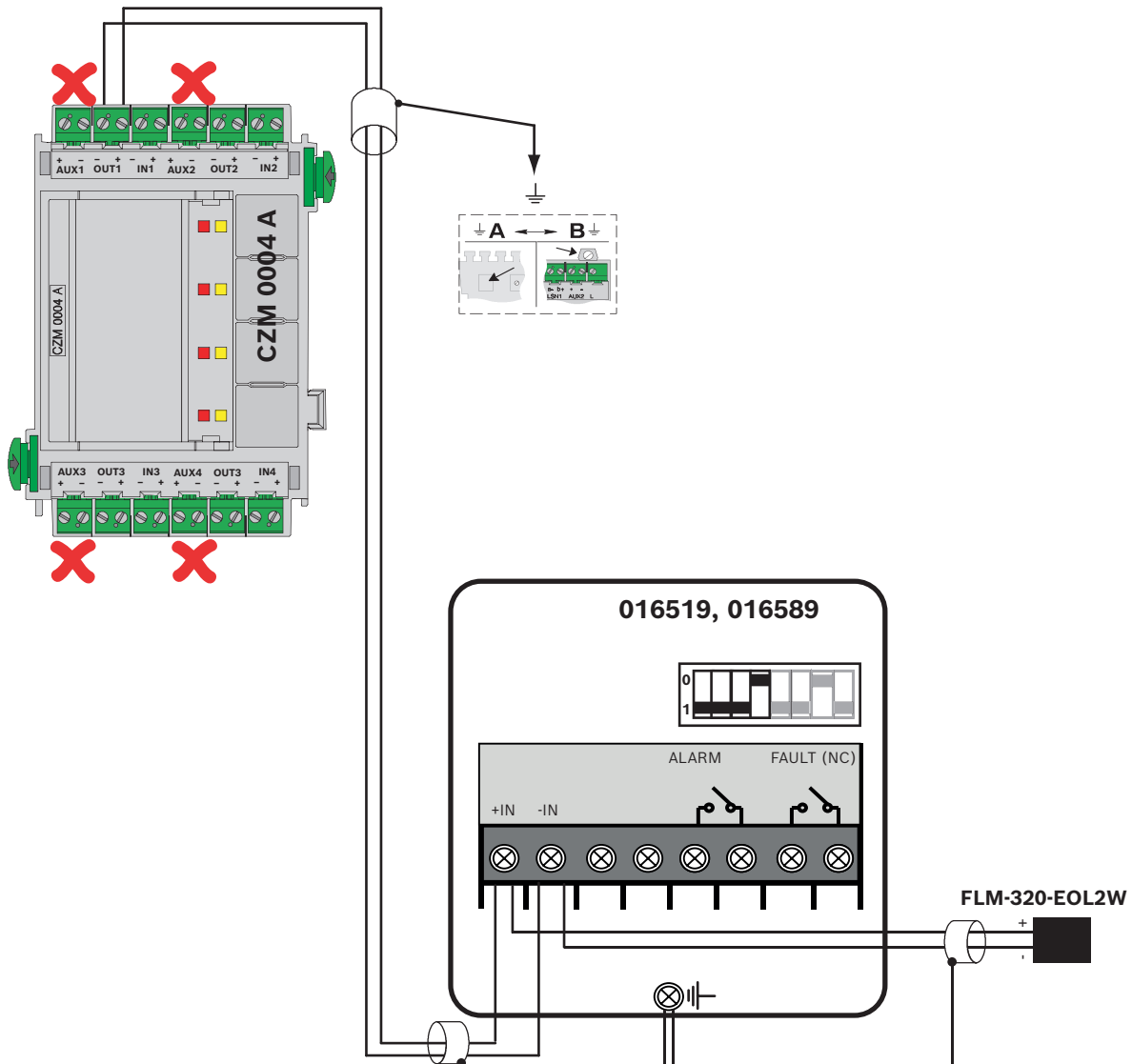

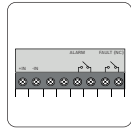

016519, 016589  
IR3 Flame Detector

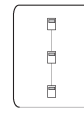

ELS

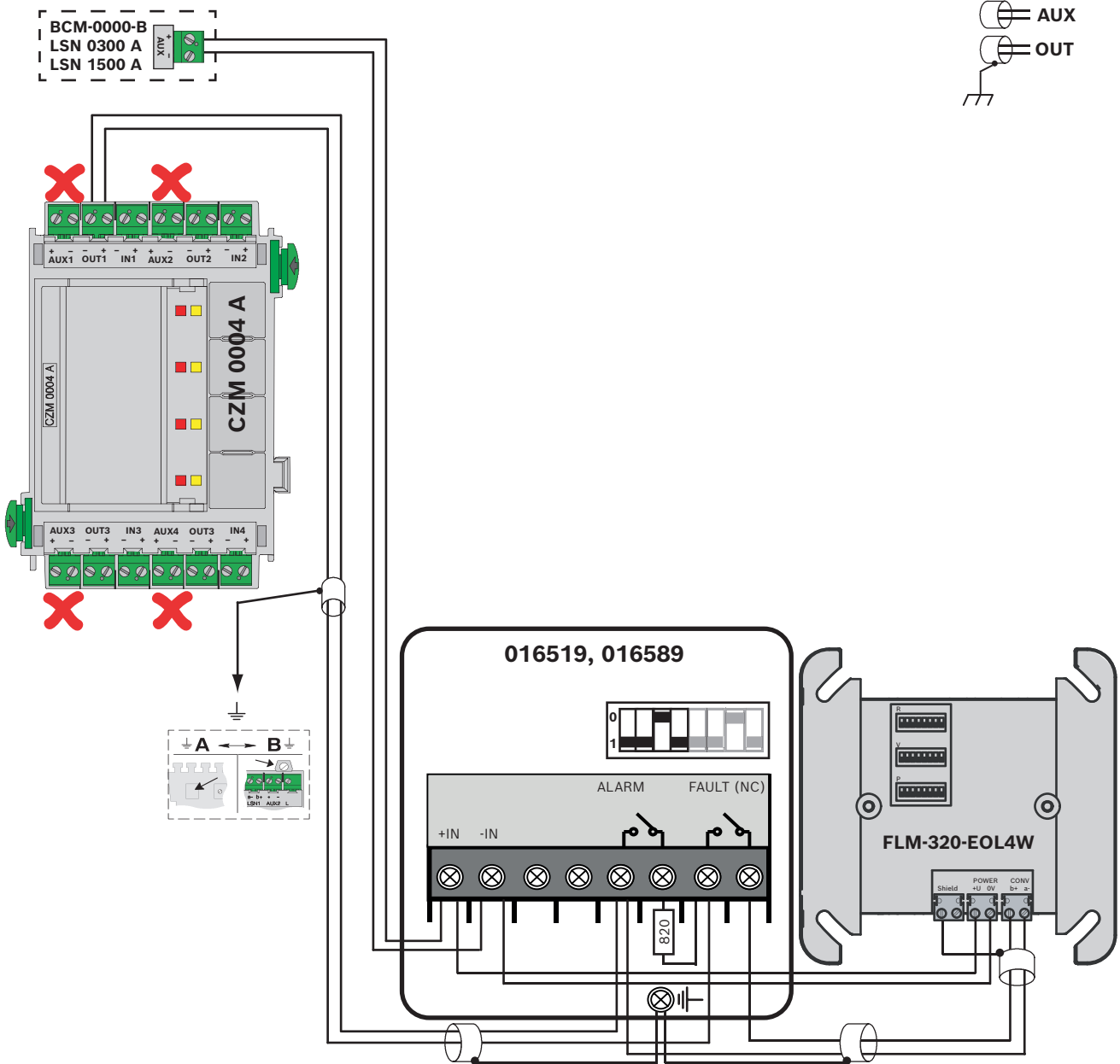



FCA-500-EU  
FCP-O 500  
FCP-O 500-P  
FCP-OC 500  
FCP-OC 500-P



ELS

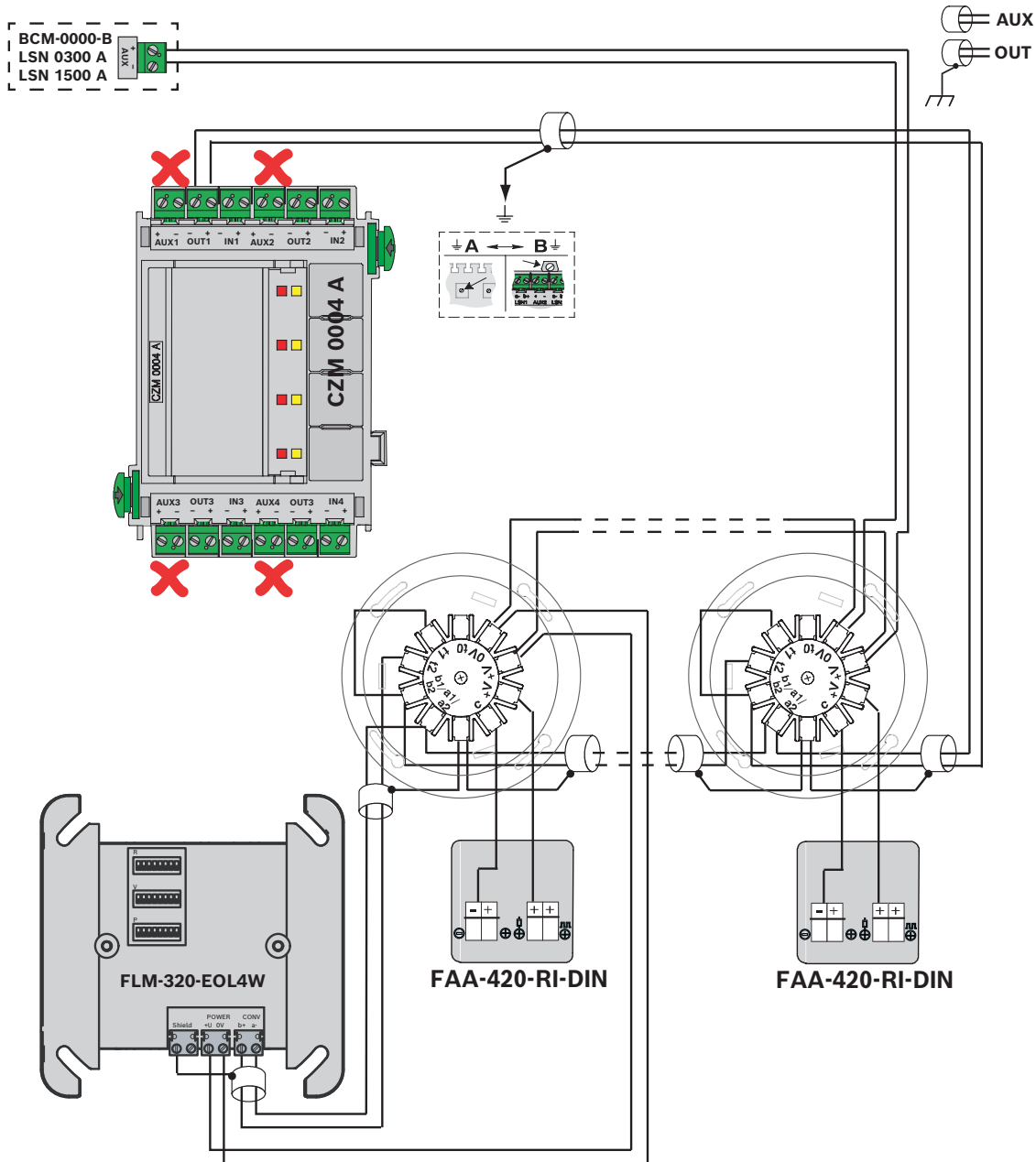

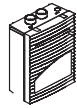

FCS-320-TM Series

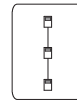

ELS

BCM-0000-B  
LSN 0300 A  
LSN 1500 A

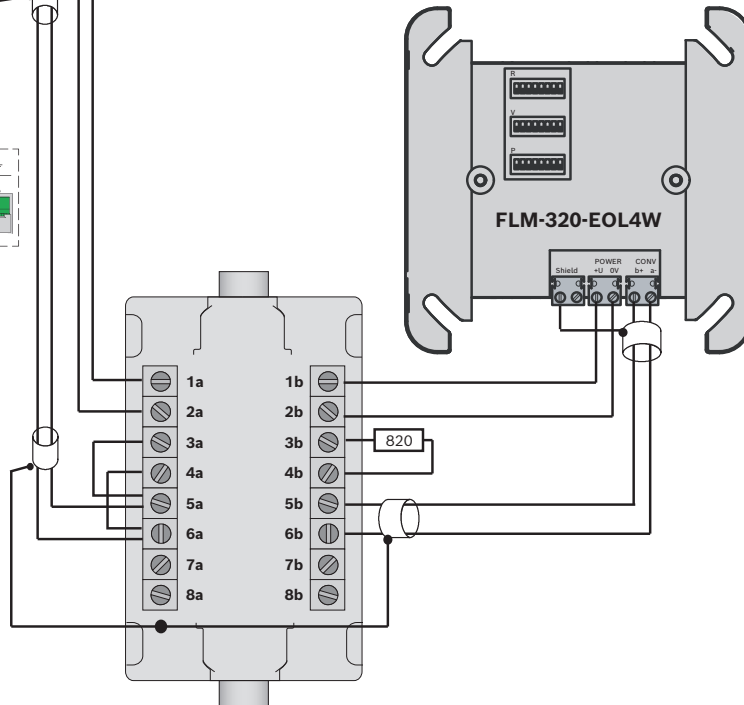
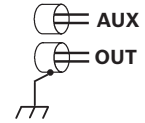
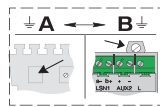
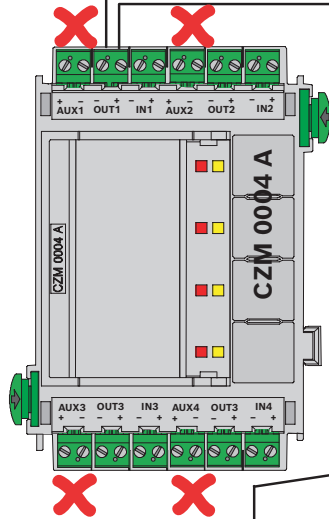



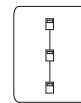
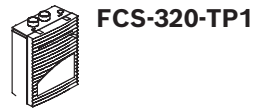

ELS

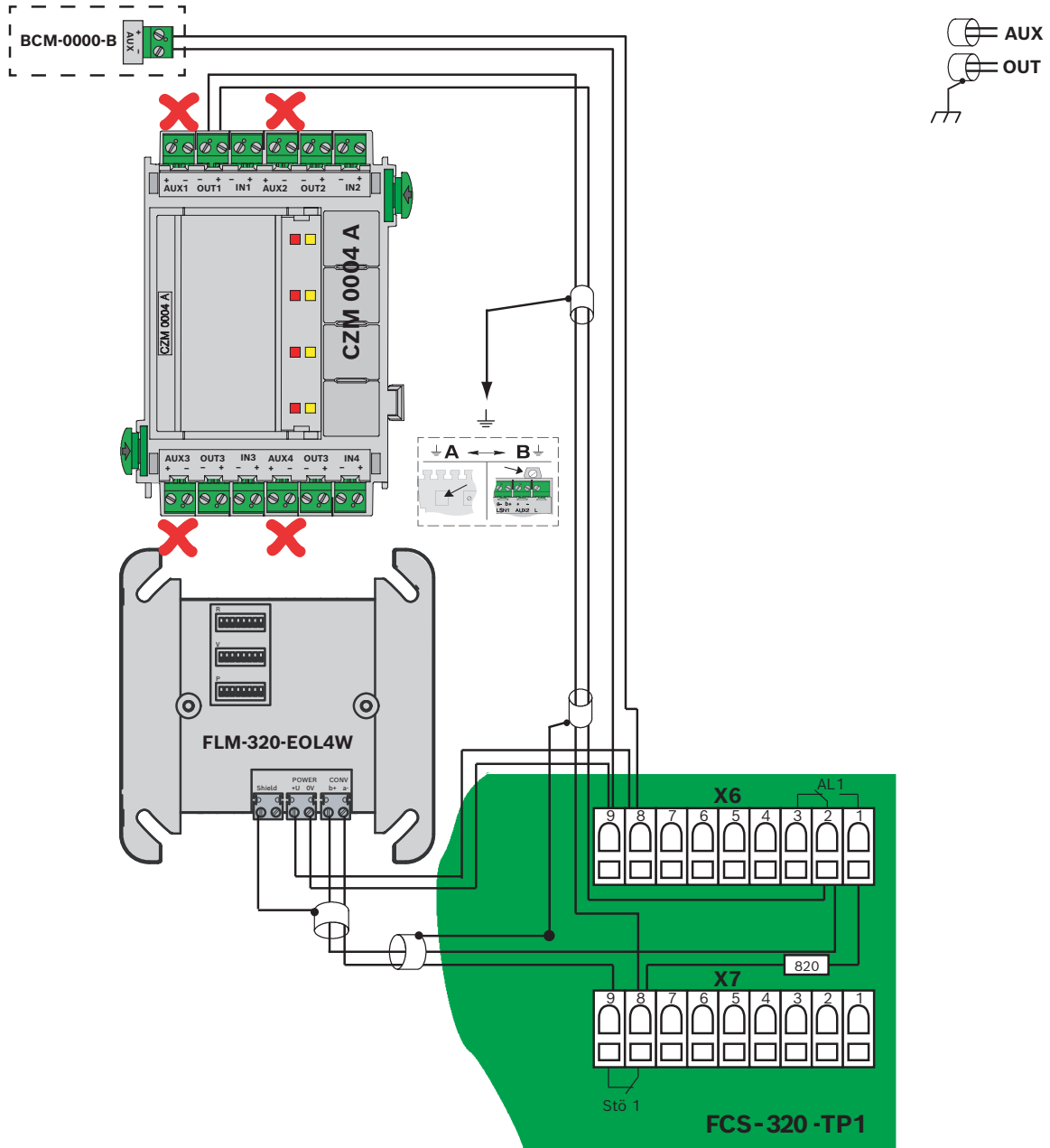

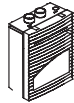

FCS-320-TP2



ELS

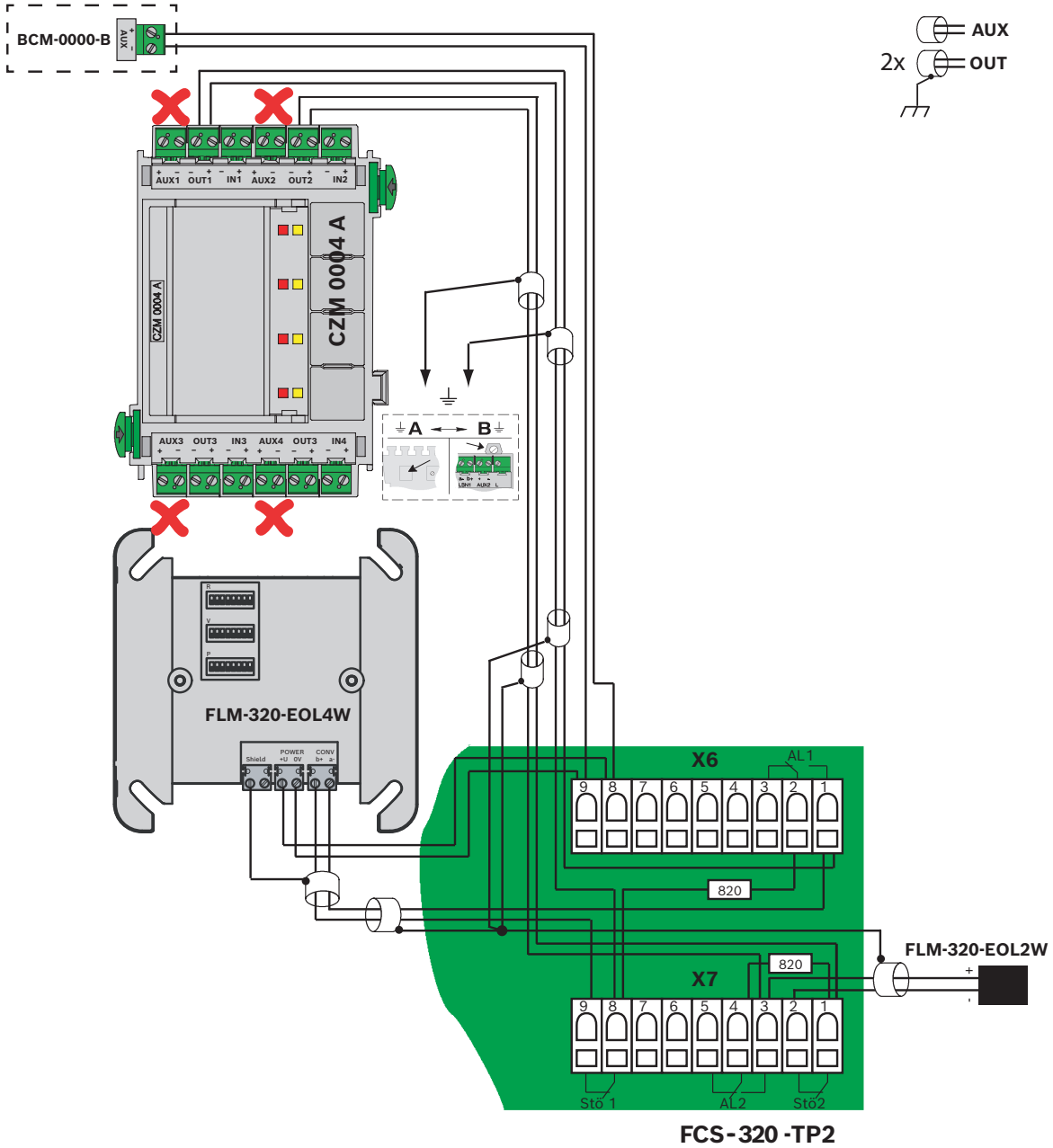



**FIRERAY3000**

1 x



**ELS**

BCM-0000-B  
LSN 0300 A  
LSN 1500 A

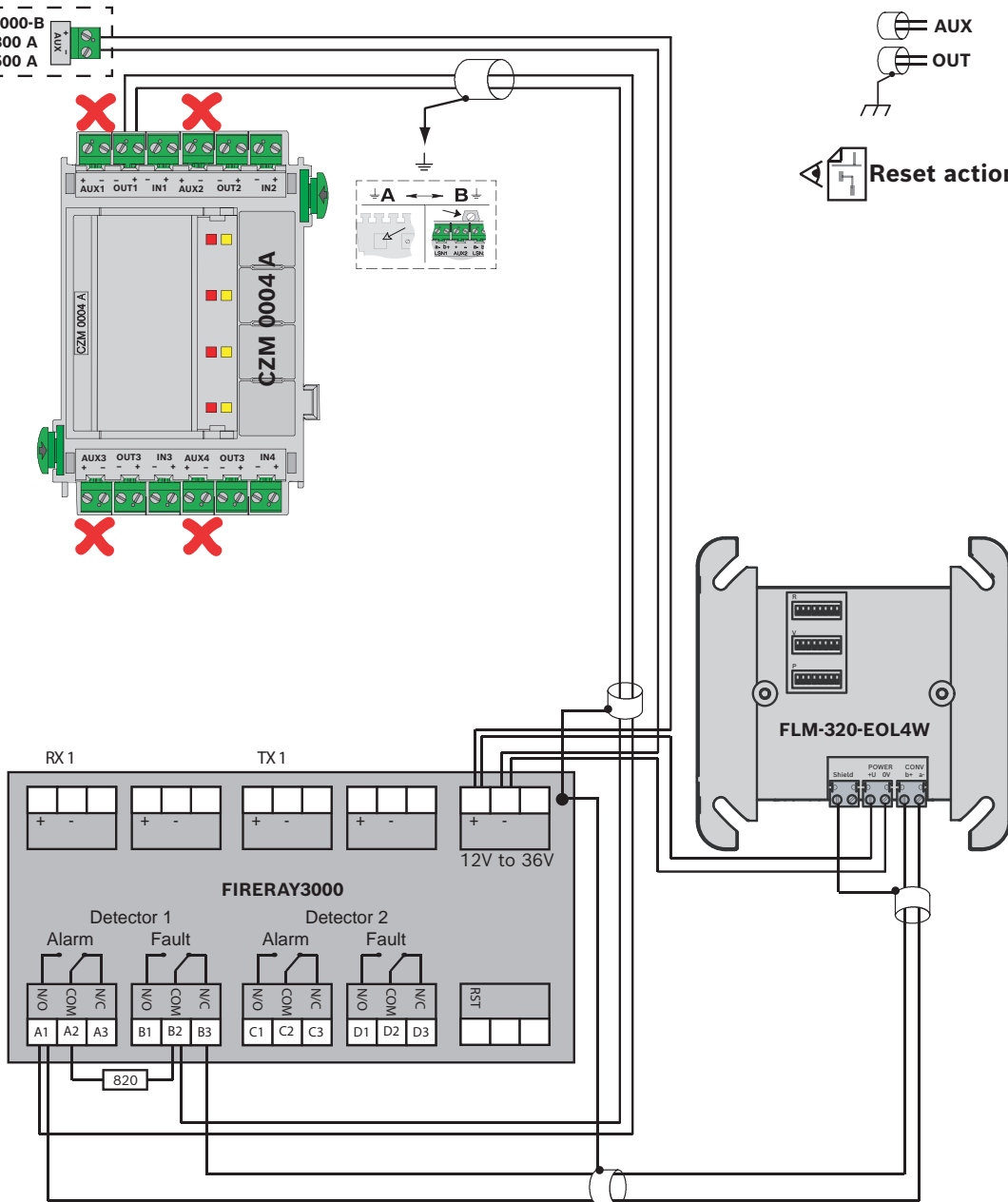

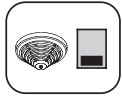

**FIRERAY3000**  
2 x **OUT1**



**ELS**

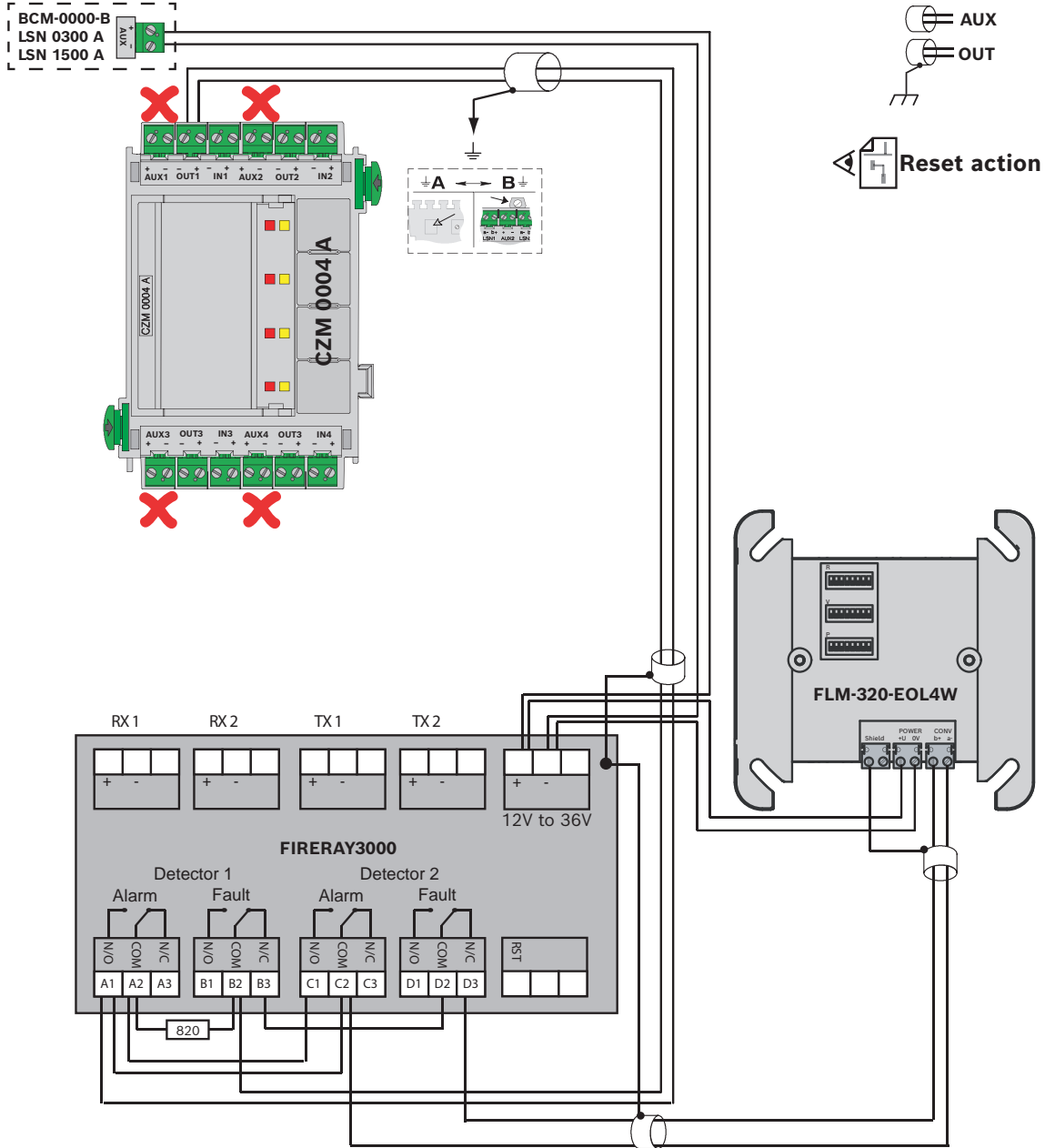



**FIRERAY3000**  
2 x **OUT1+2**



**ELS**

BCM-0000-B  
LSN 0300 A  
LSN 1500 A

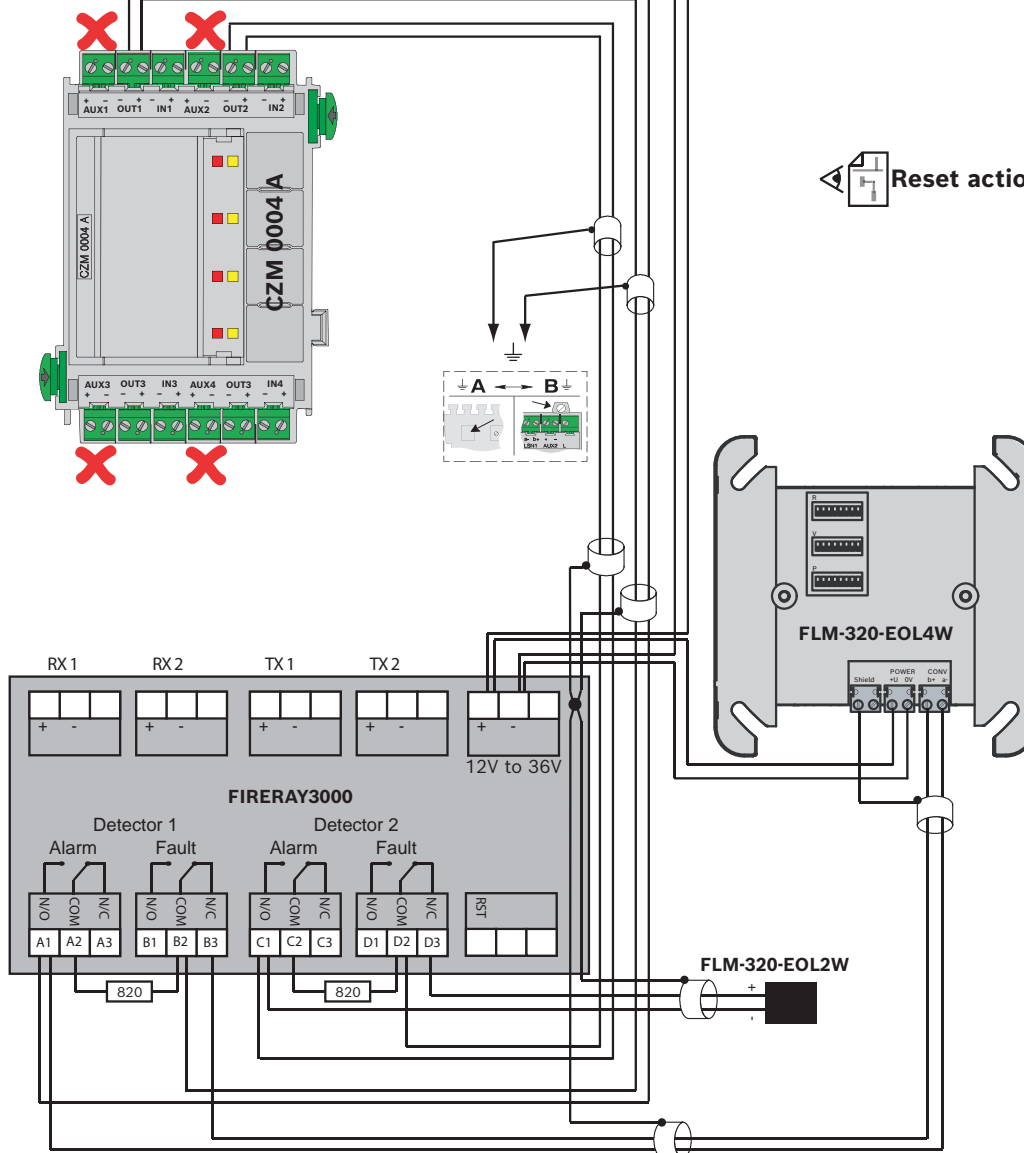

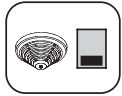

**FIRERAY5000**

1 x



**ELS**

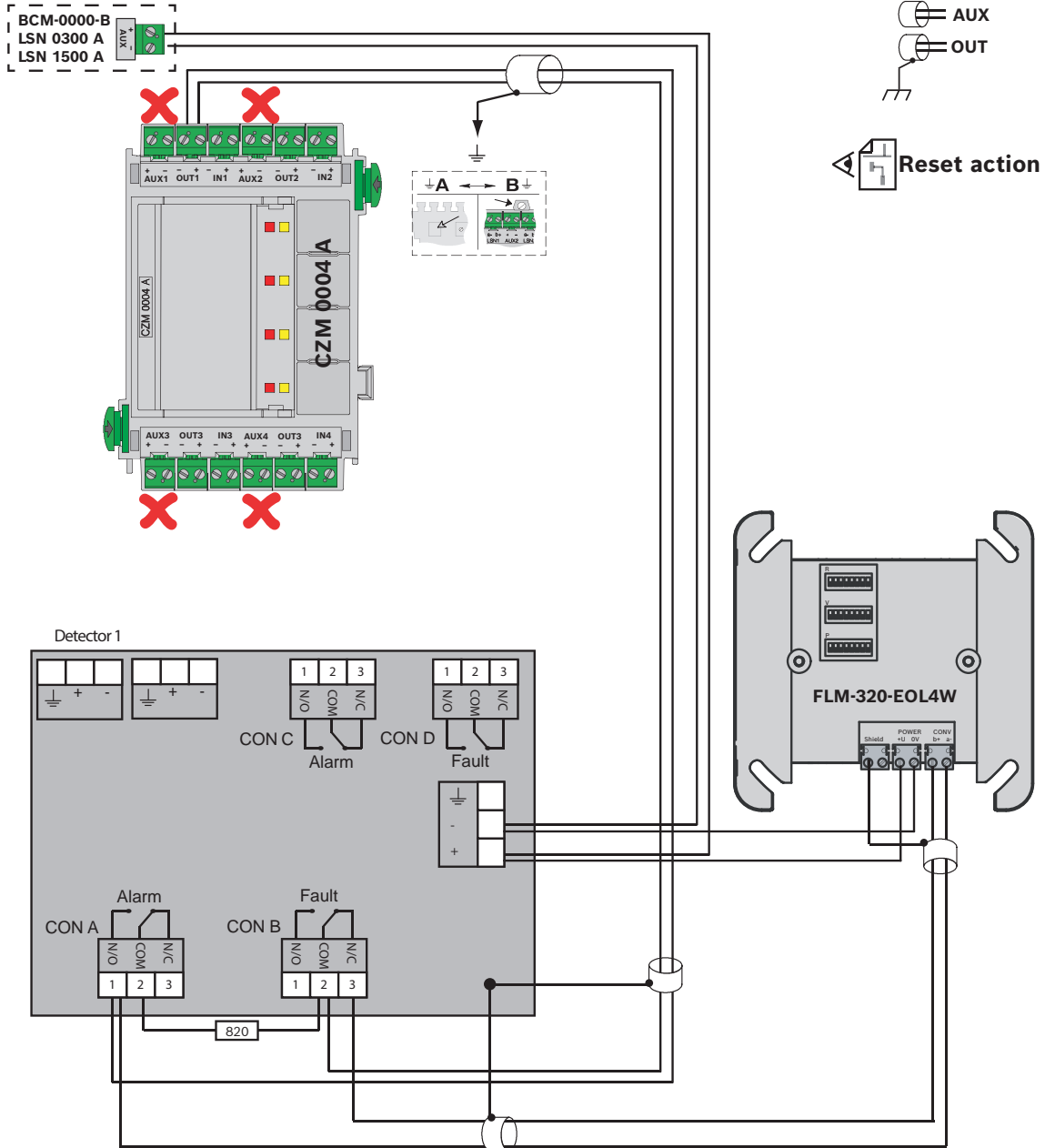

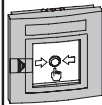

FMC-120-DKM-G-R  
 FMC-120-DKM-H-R  
 FMC-120-DKM-G-B  
 FMC-120-DKM-H-B  
 FMC-120-DKM-G-Y

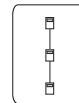

ELS

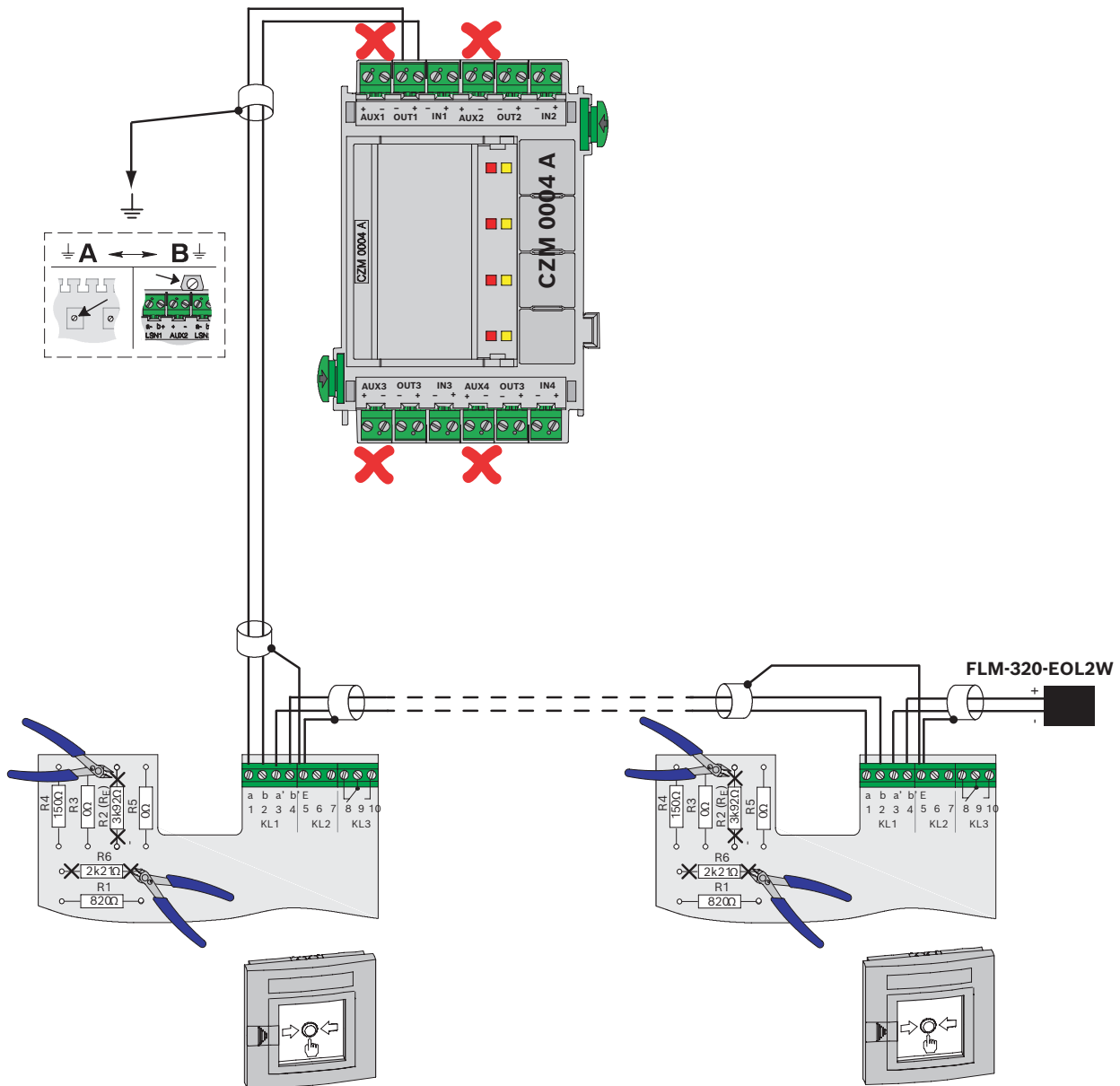

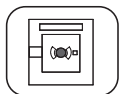

FMC-300RW-GSGBU  
FMC-300RW-GSRBU  
FMC-300RW-GSGRD  
FMC-300RW-GSRRD  
FMC-300RW-GSGYE  
FMC-300RW-GSRYE



ELS

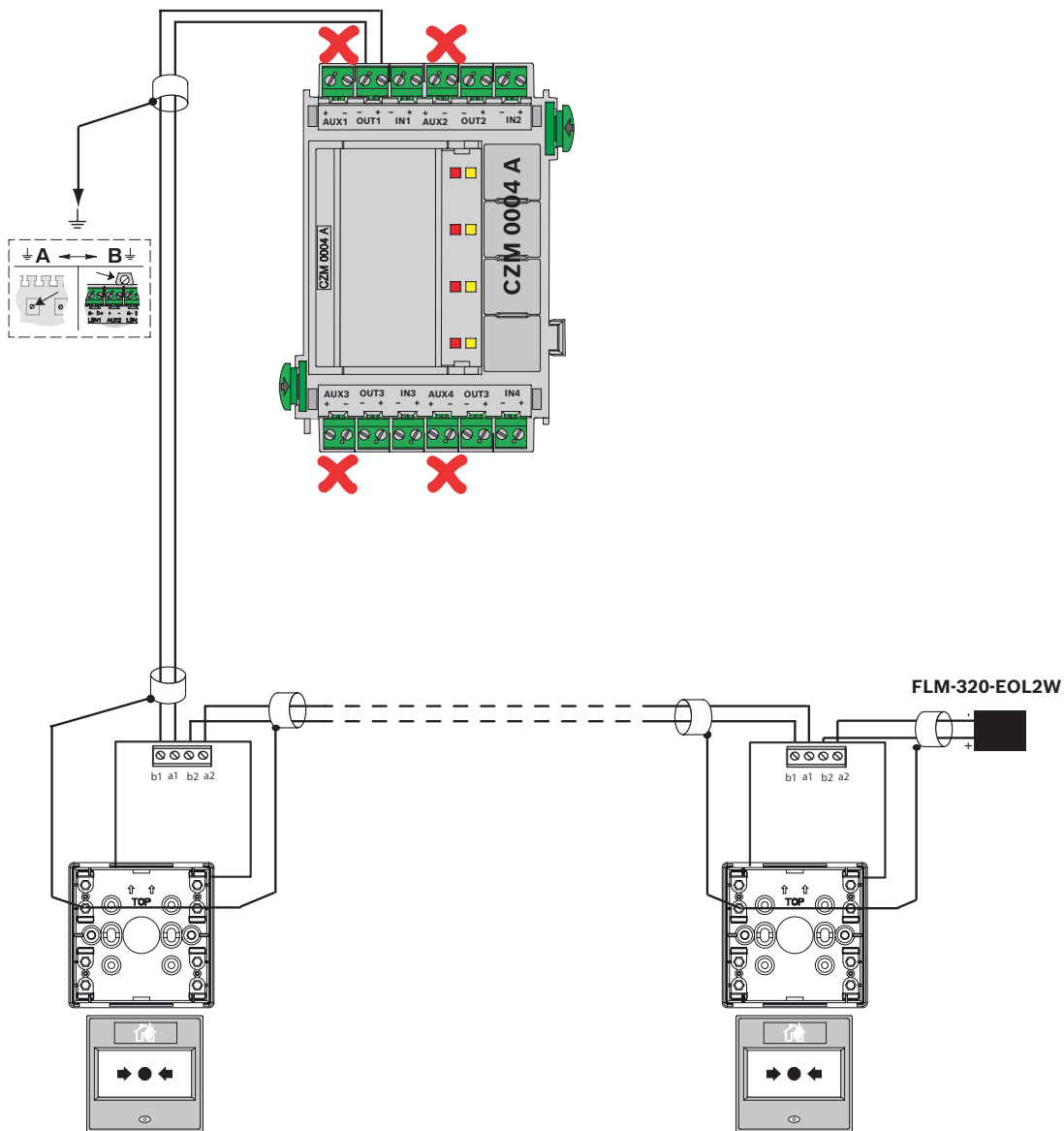



2.6.2 LSN 0300 A

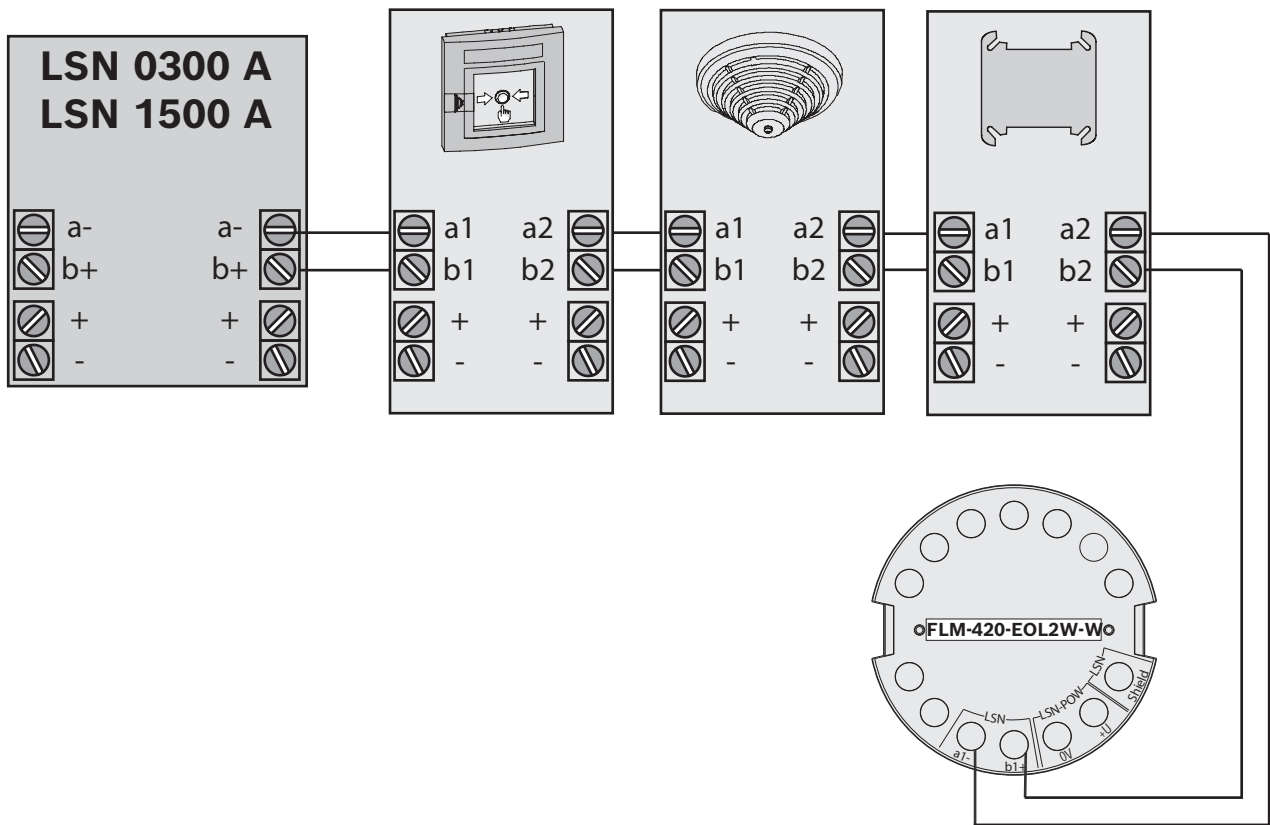
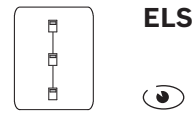

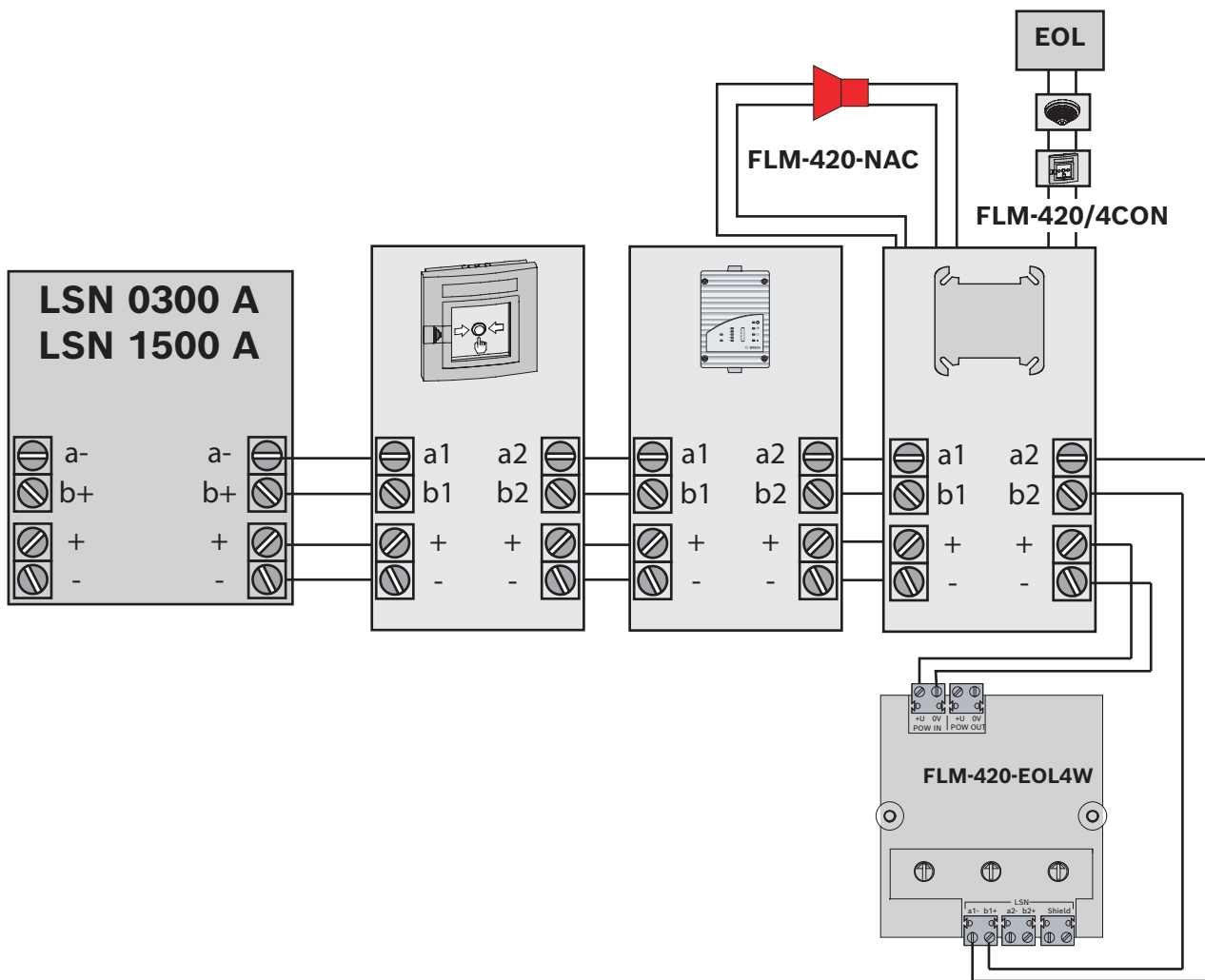
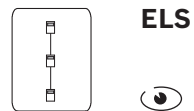

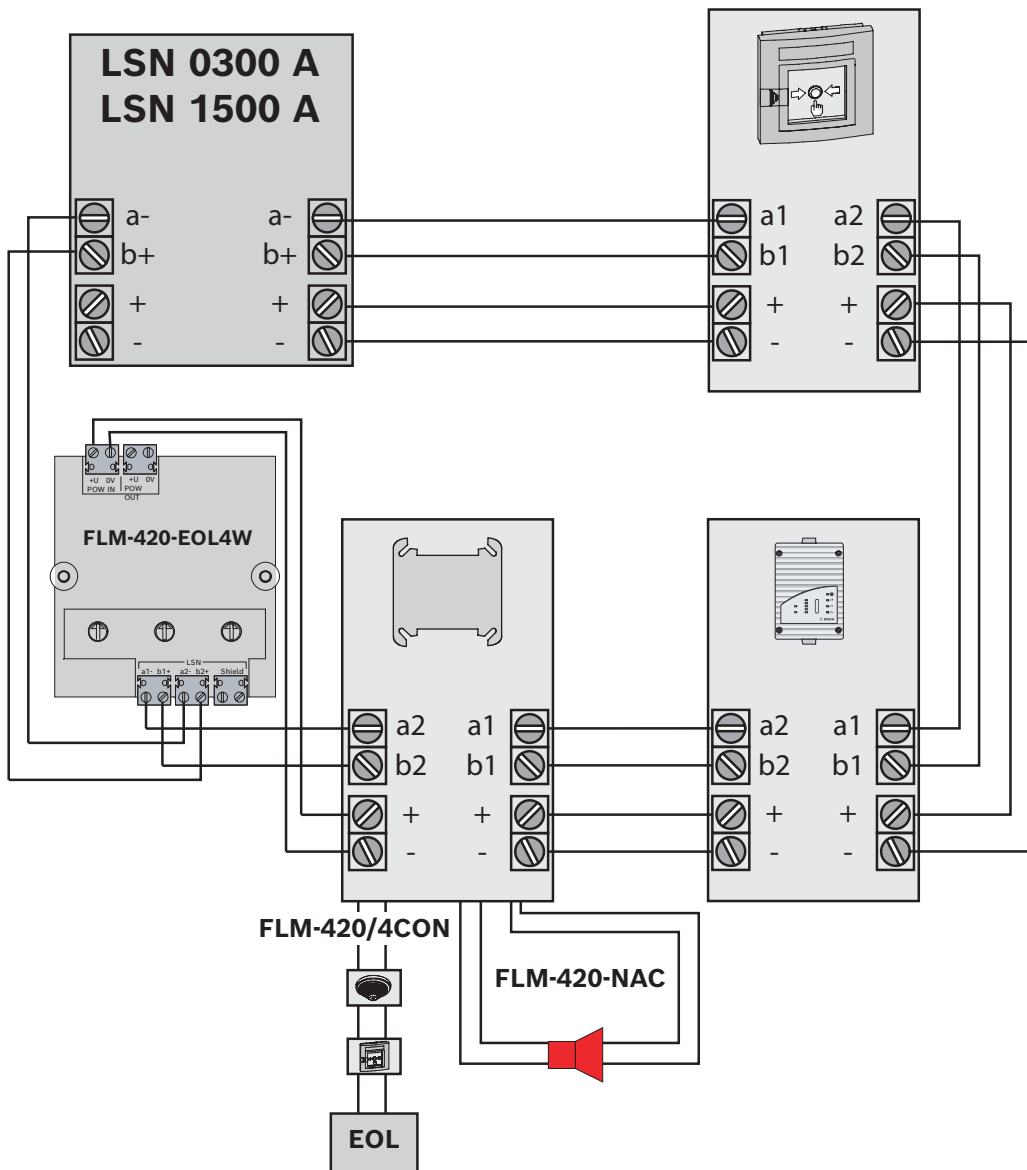
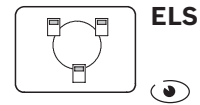

Reset action

ELS

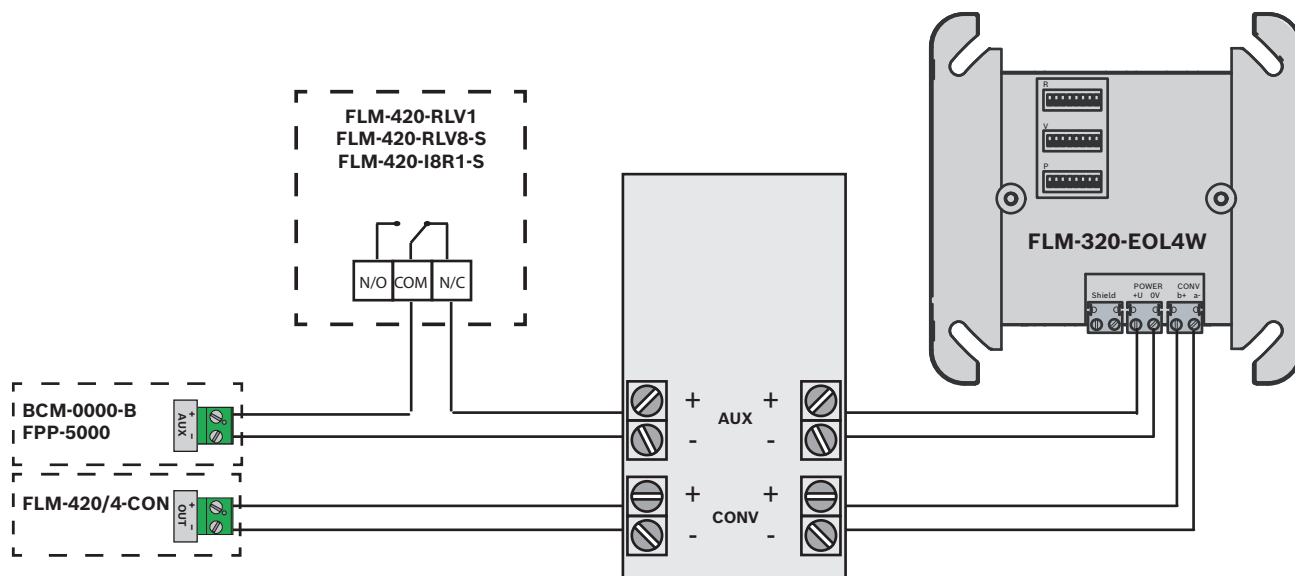

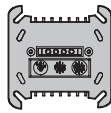
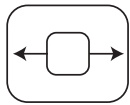

FLM-420-I2-D  
 FLM-420-O111-D  
 FLM-420-RHV-D/S  
 FLM-420-RLV1-D

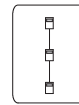

ELS

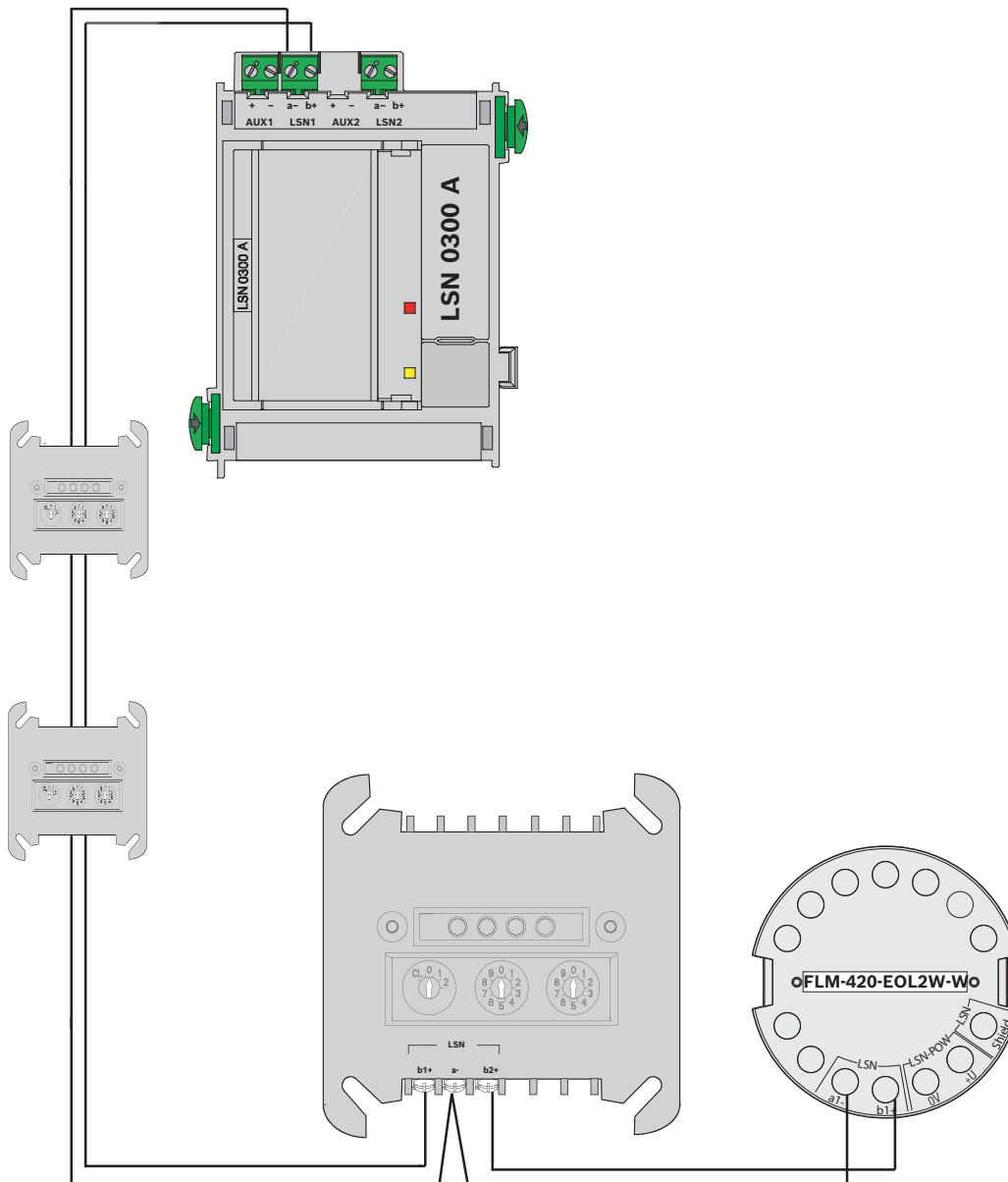



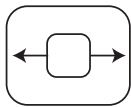

**FLM-420-18R1-S**

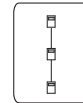

**ELC**

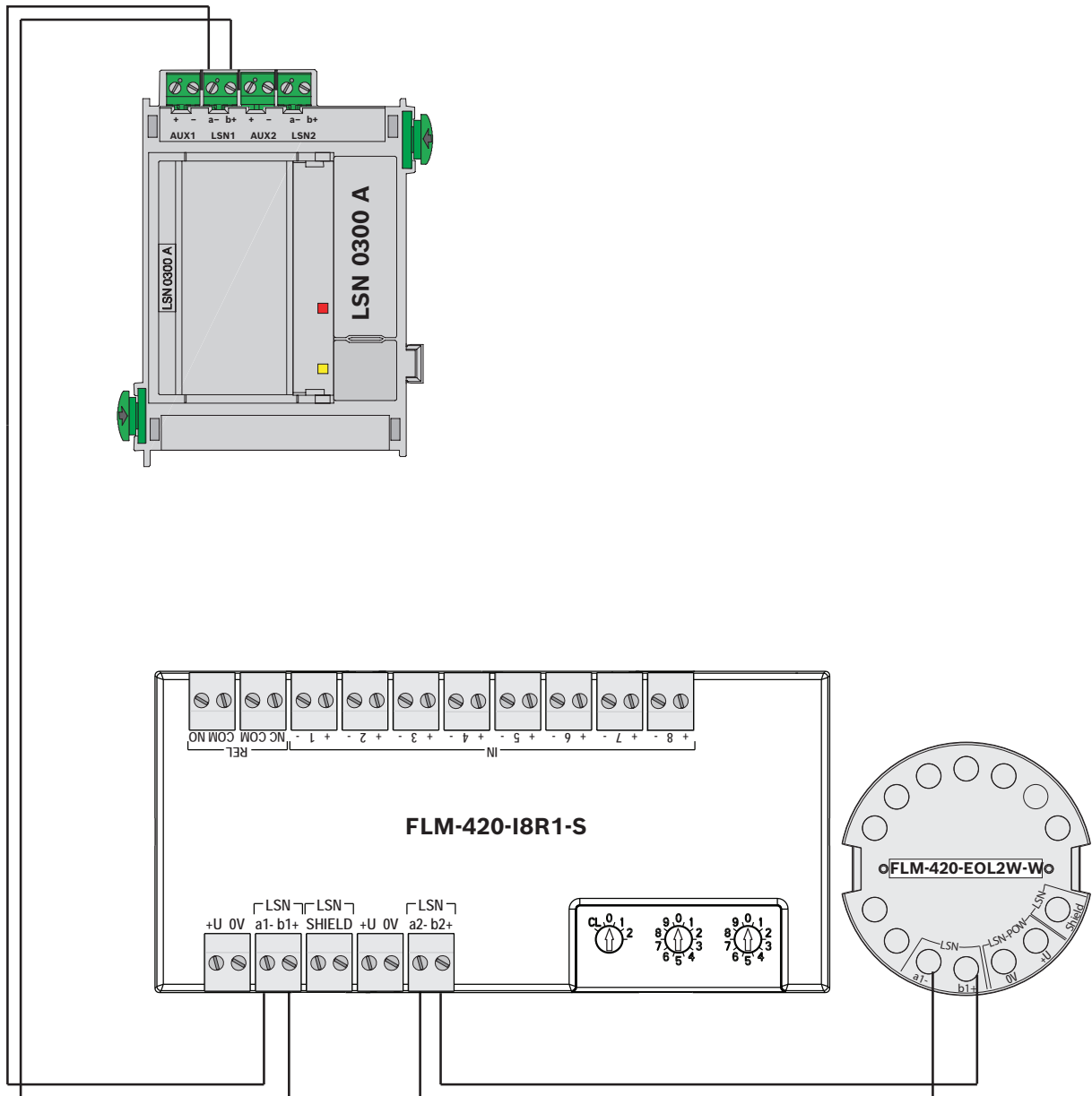

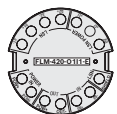
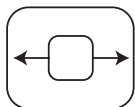

FLM-420-O1I1-E

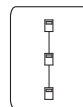

ELS

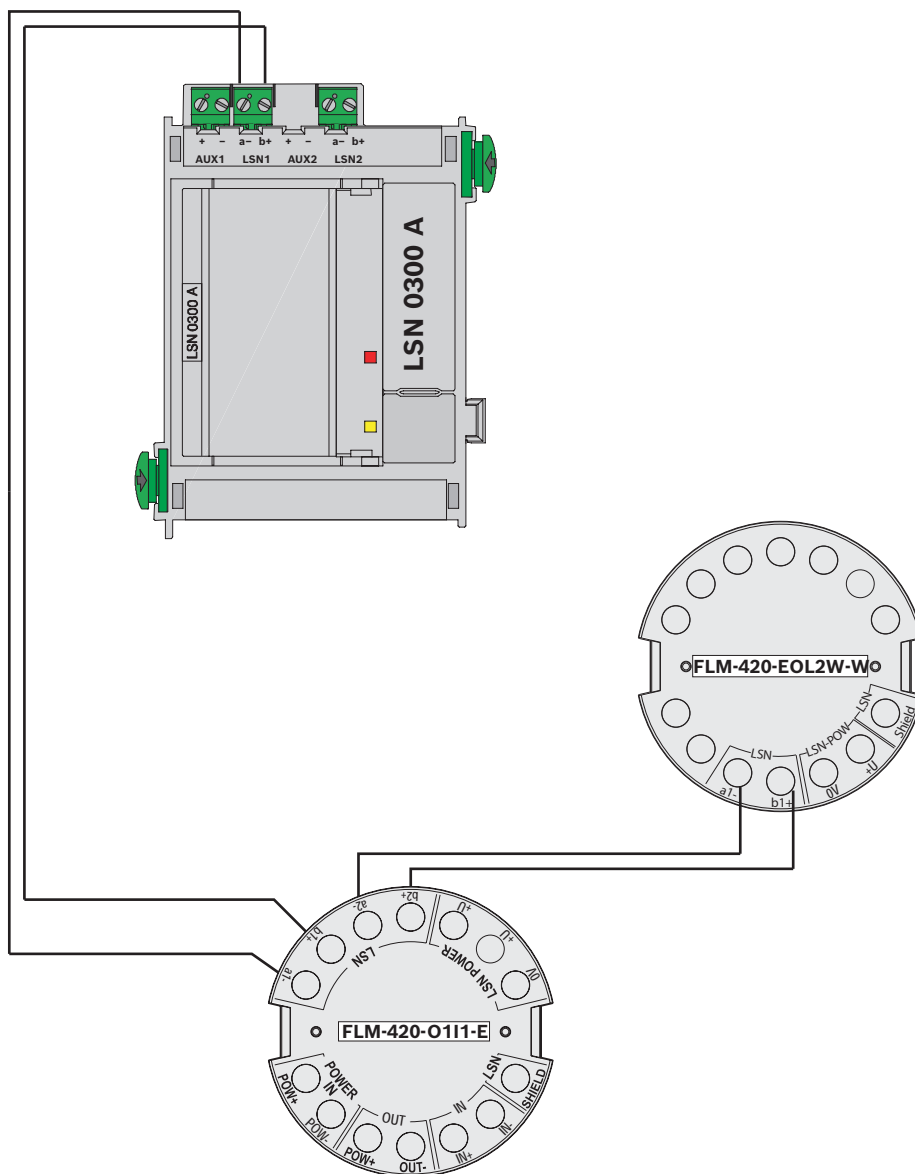



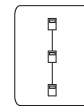
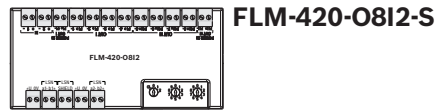
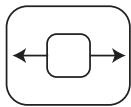

ELS

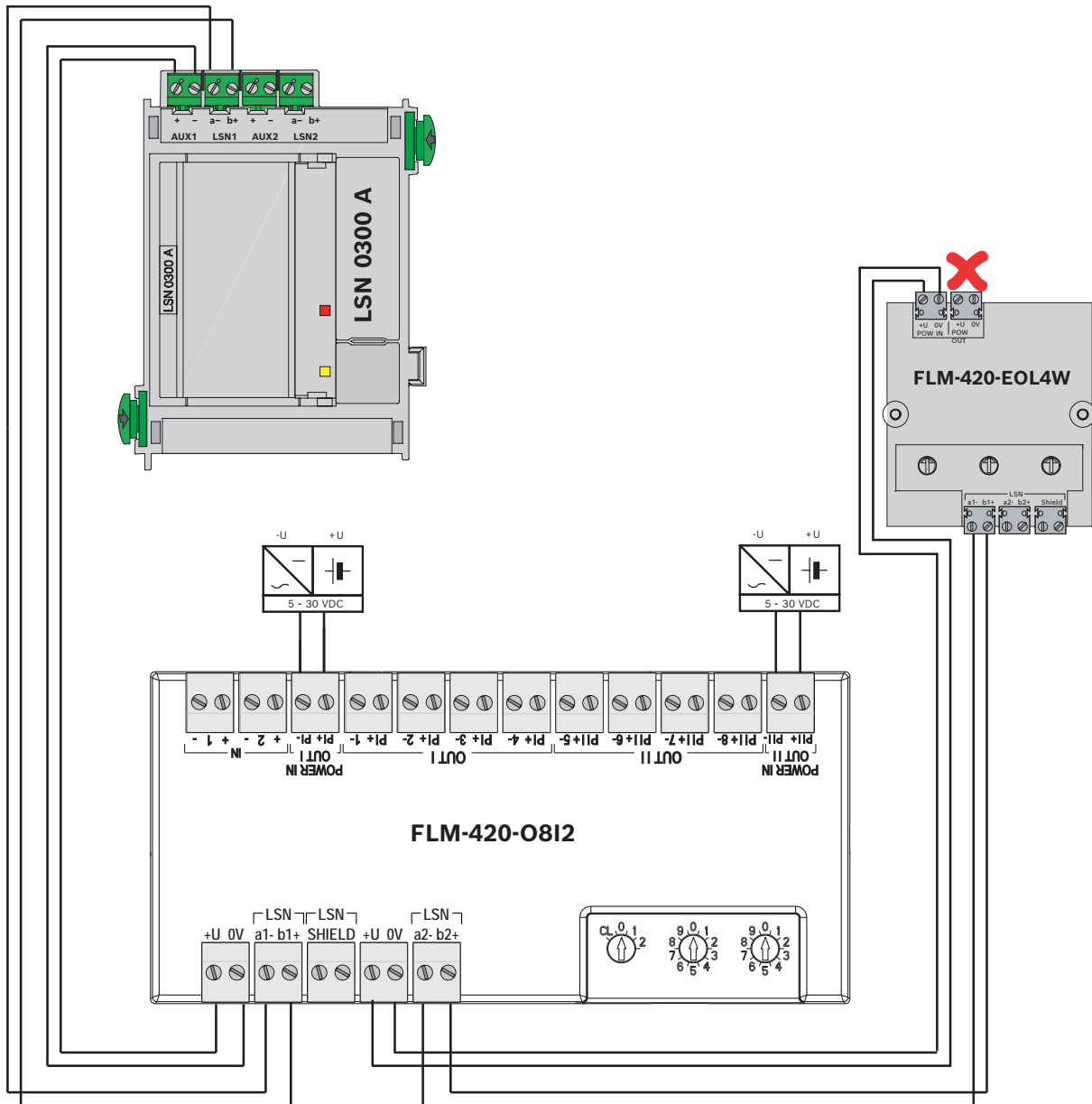

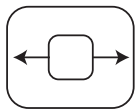

**FLM-420-I2-E/-W**  
**FLM-420-RLV1-E**

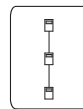

**ELS**

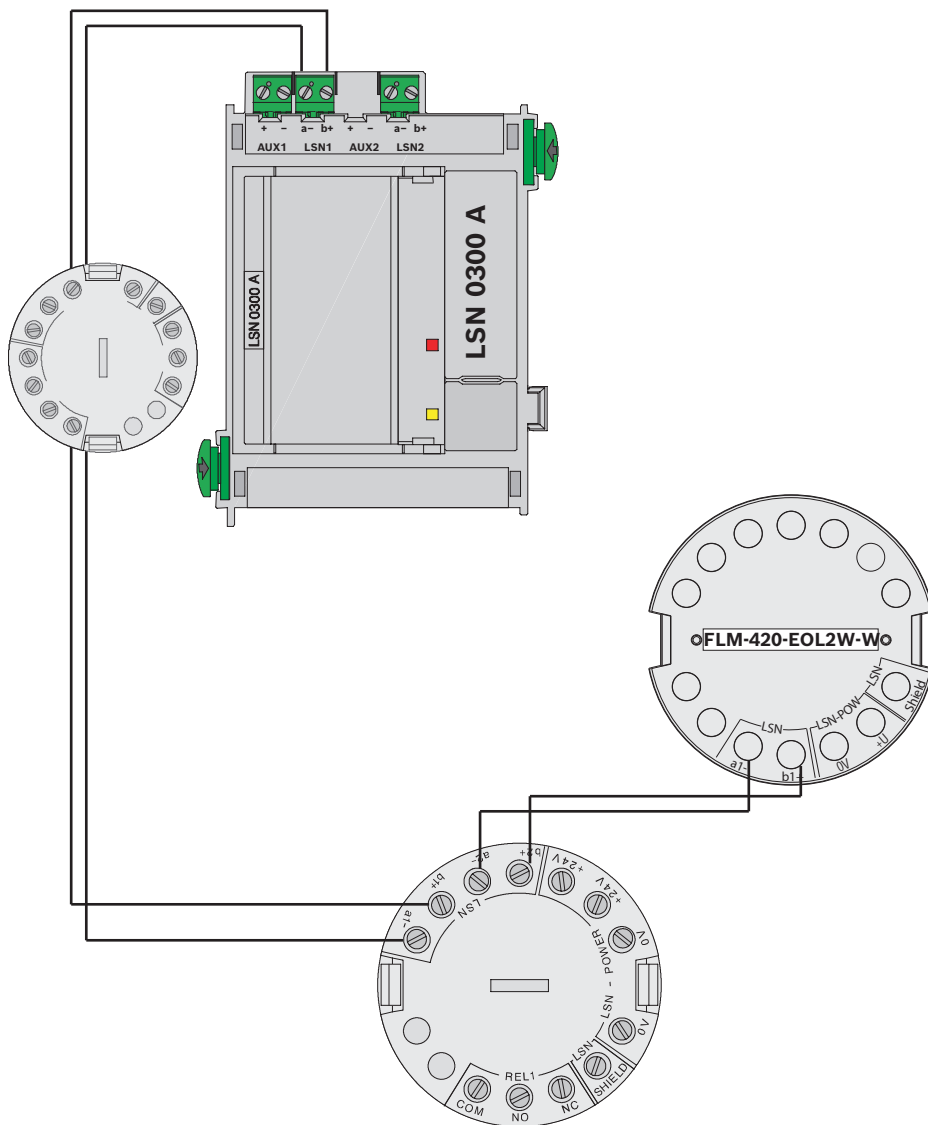

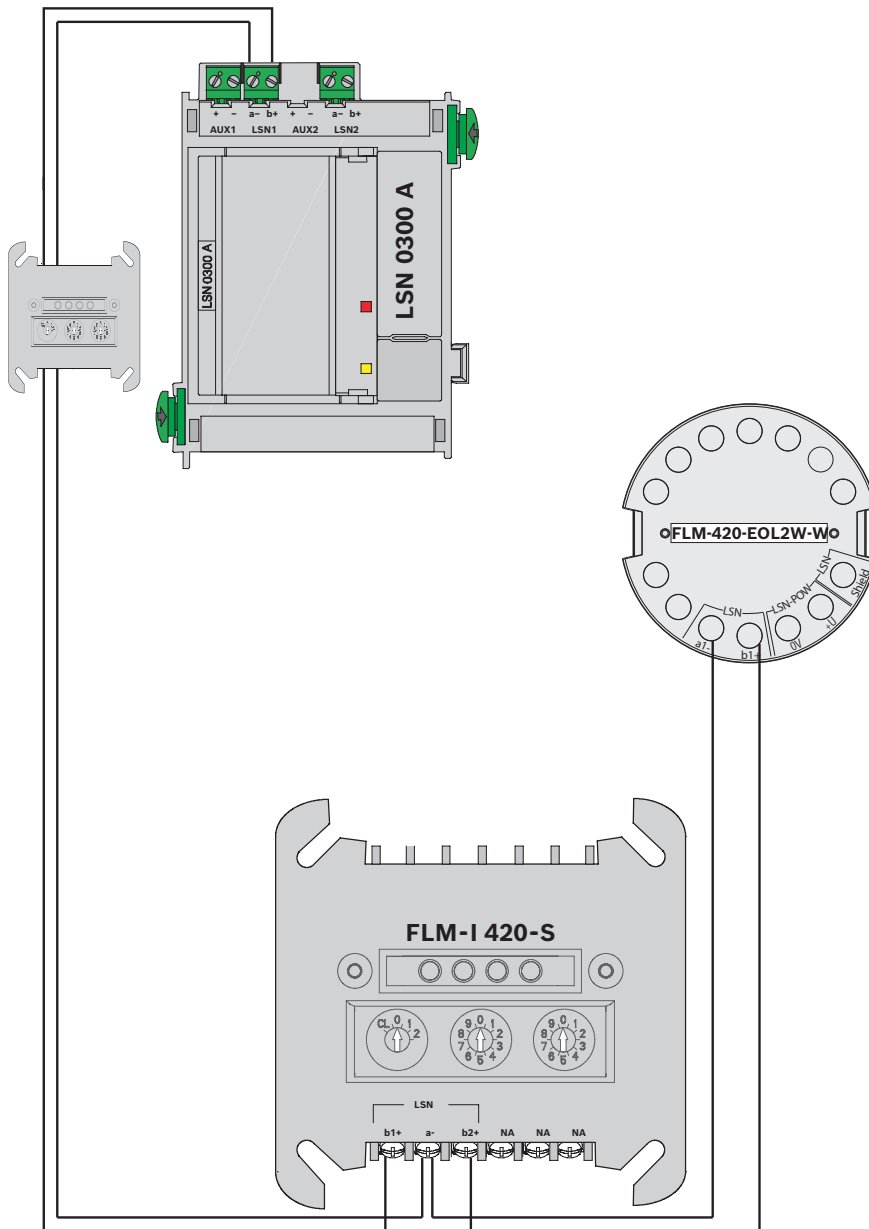
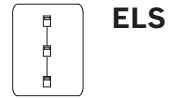
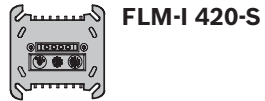
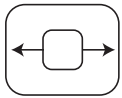

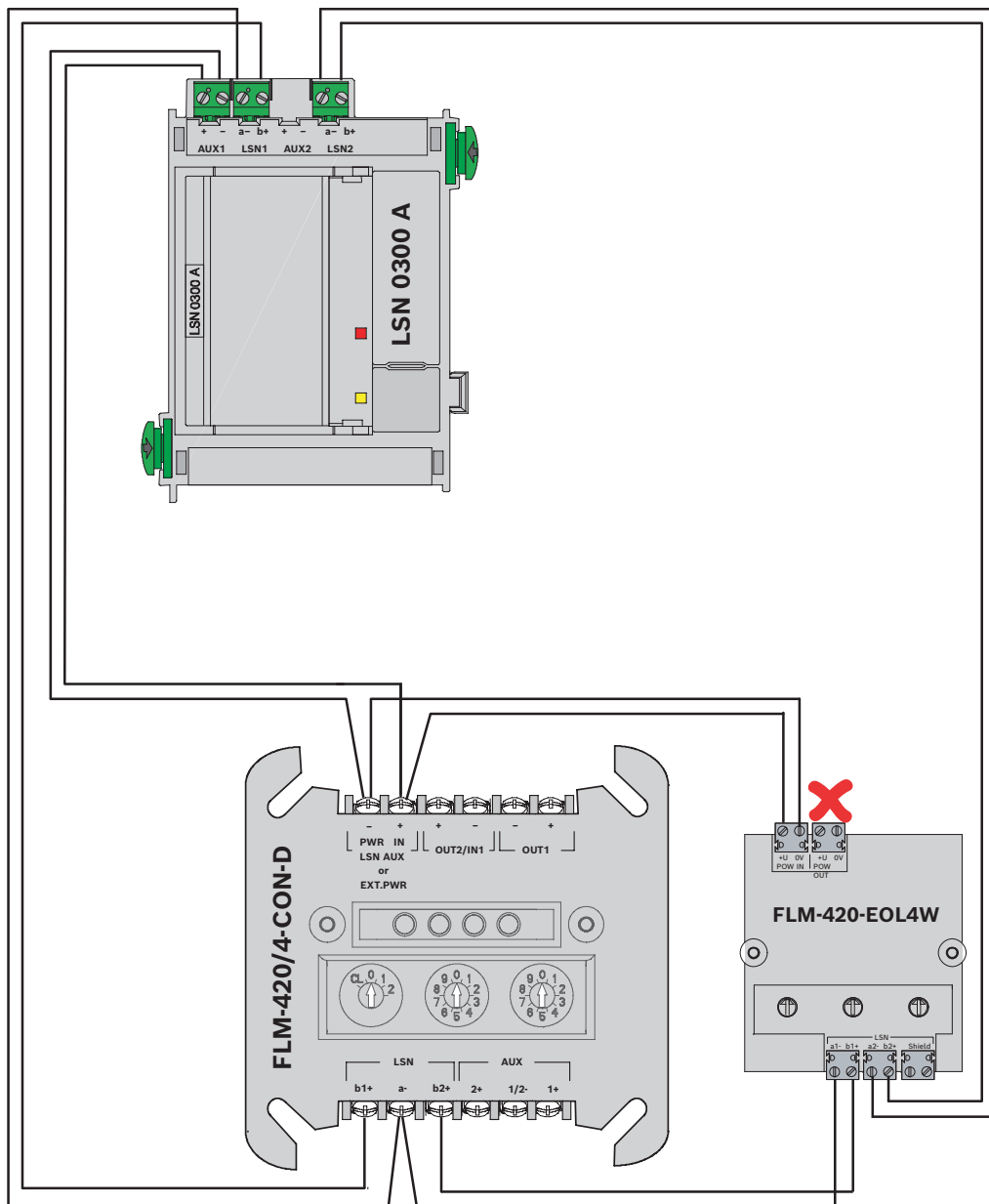
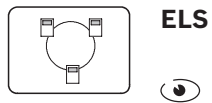
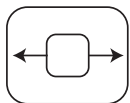

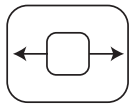

**FLM-420/  
4-CON-D**

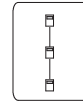

**ELS**

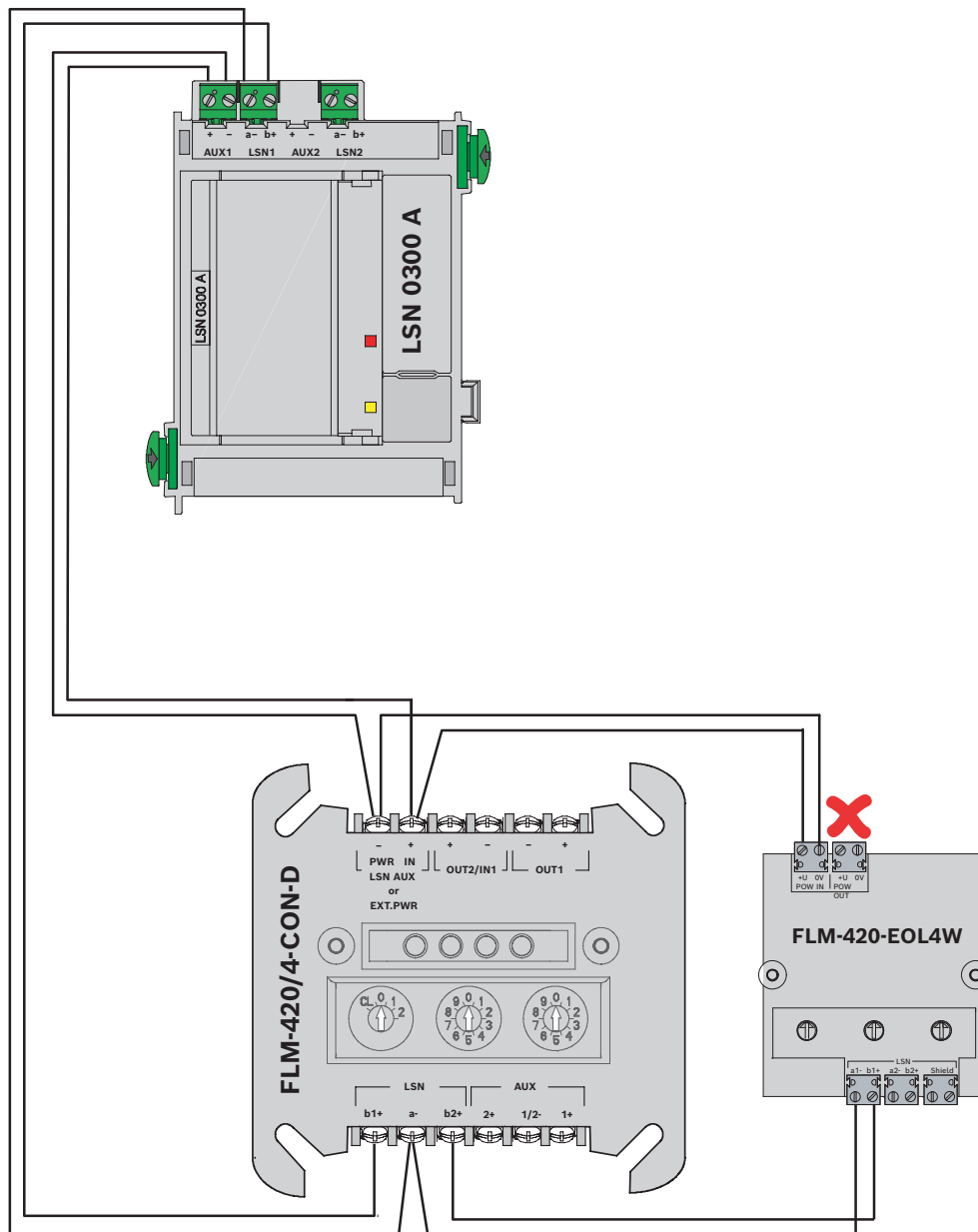

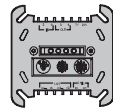
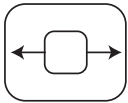

FLM-420-NAC-D/S

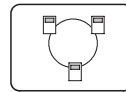

ELS  
EN 54-2

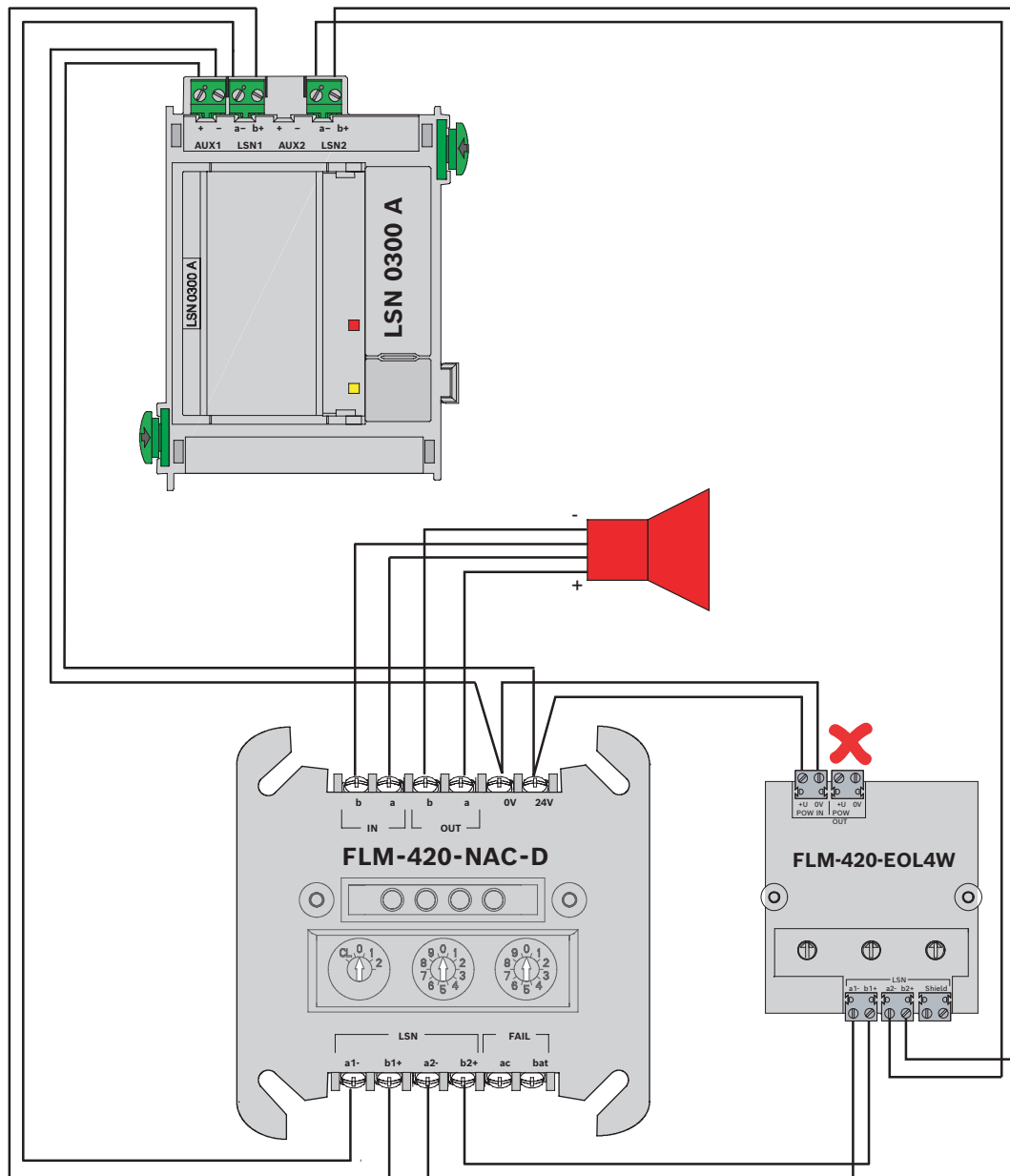

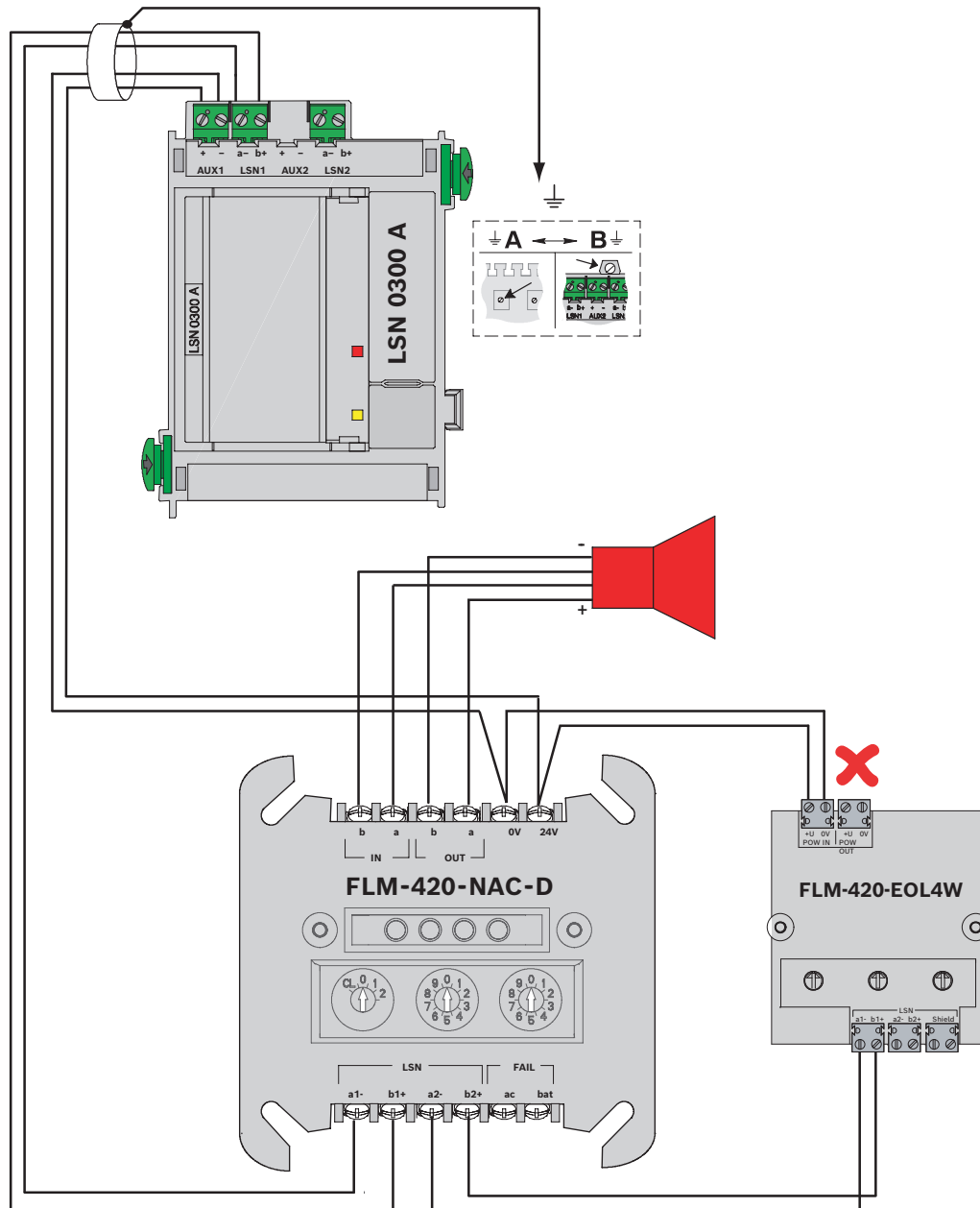
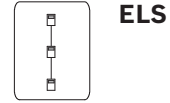
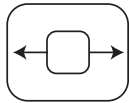

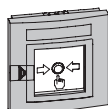
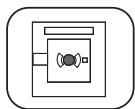

FMC-210...

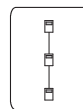

ELS

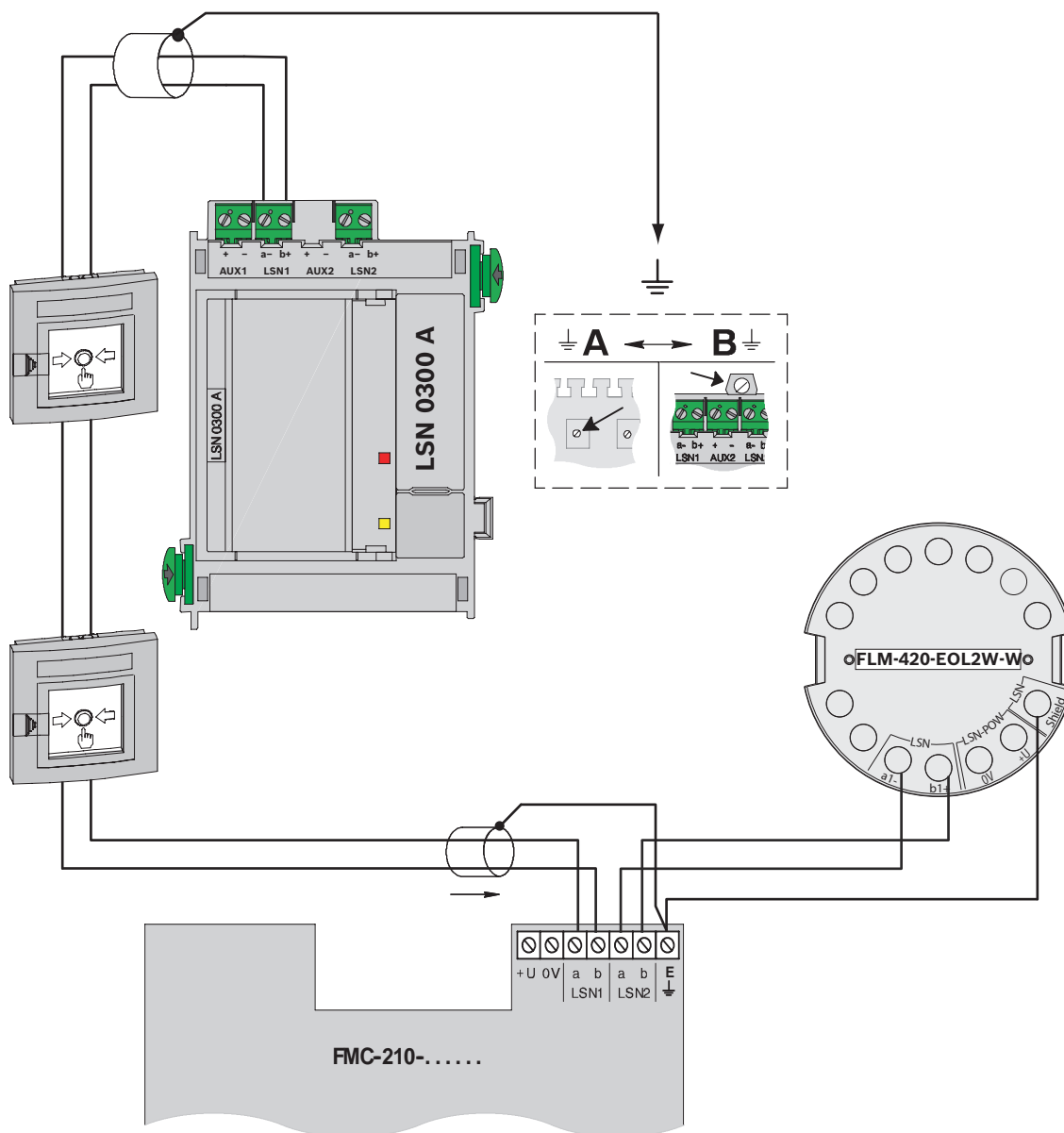



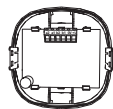

**FNM-420-A /-B**  
**FNM-420U-A /-B**  
**FNM-420V-A**

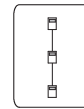

**ELS**

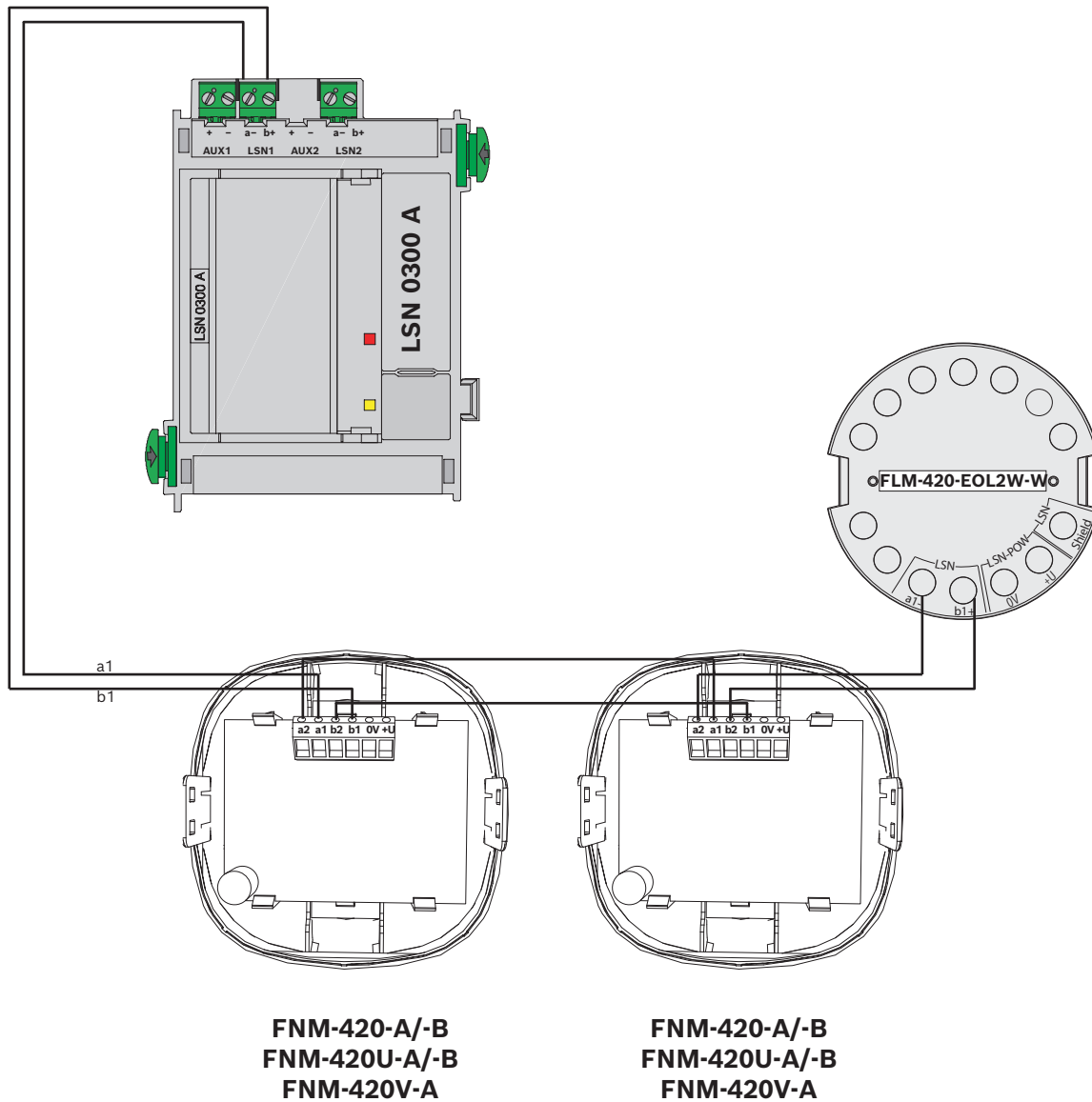





**FNM-420-A-BS**  
**FNM-420U-A-BS**



**ELS**

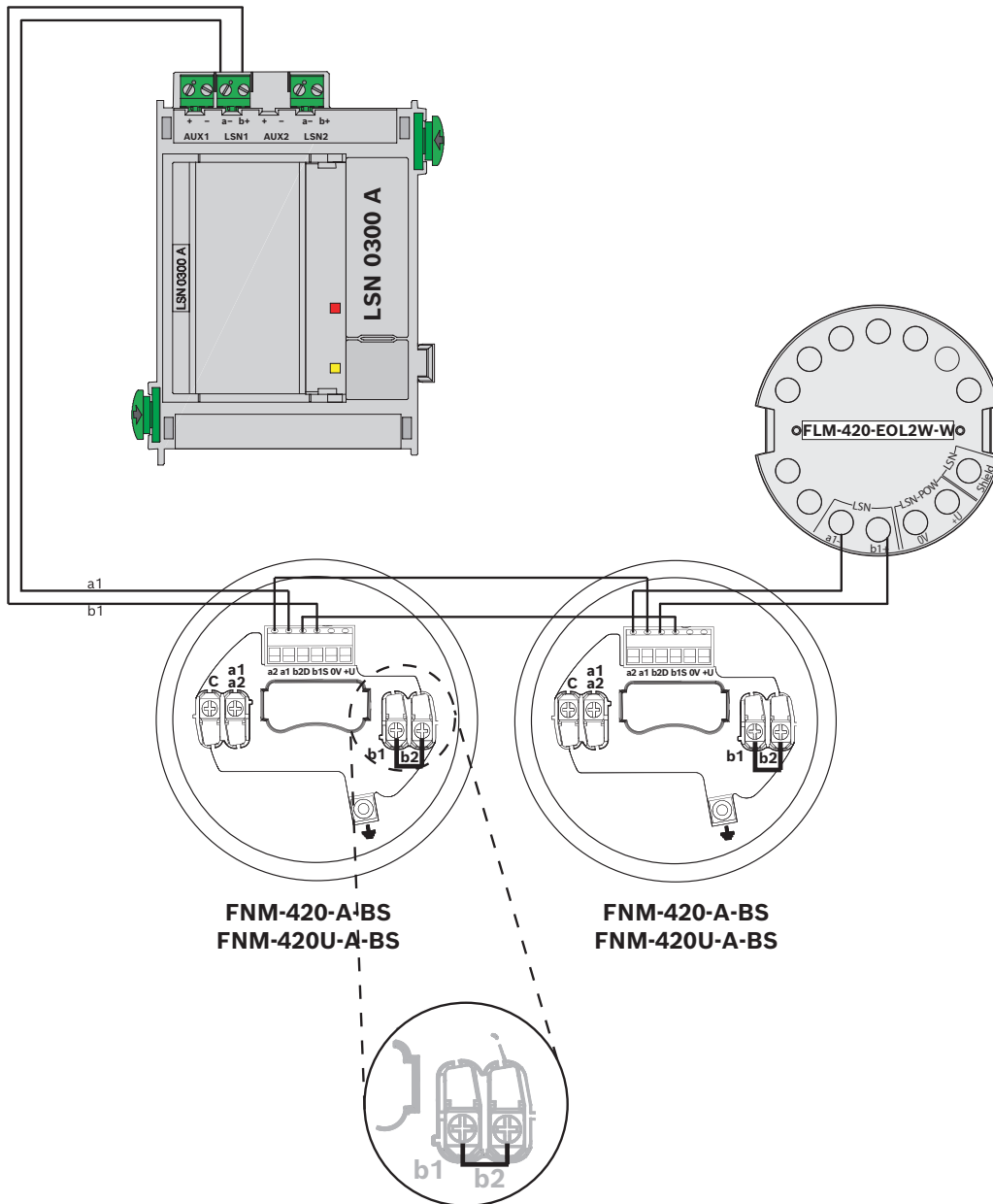

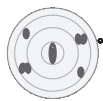

FAP-0520  
FAP-0520-P  
FAP-OC520  
FAP-OC-520-P



ELS

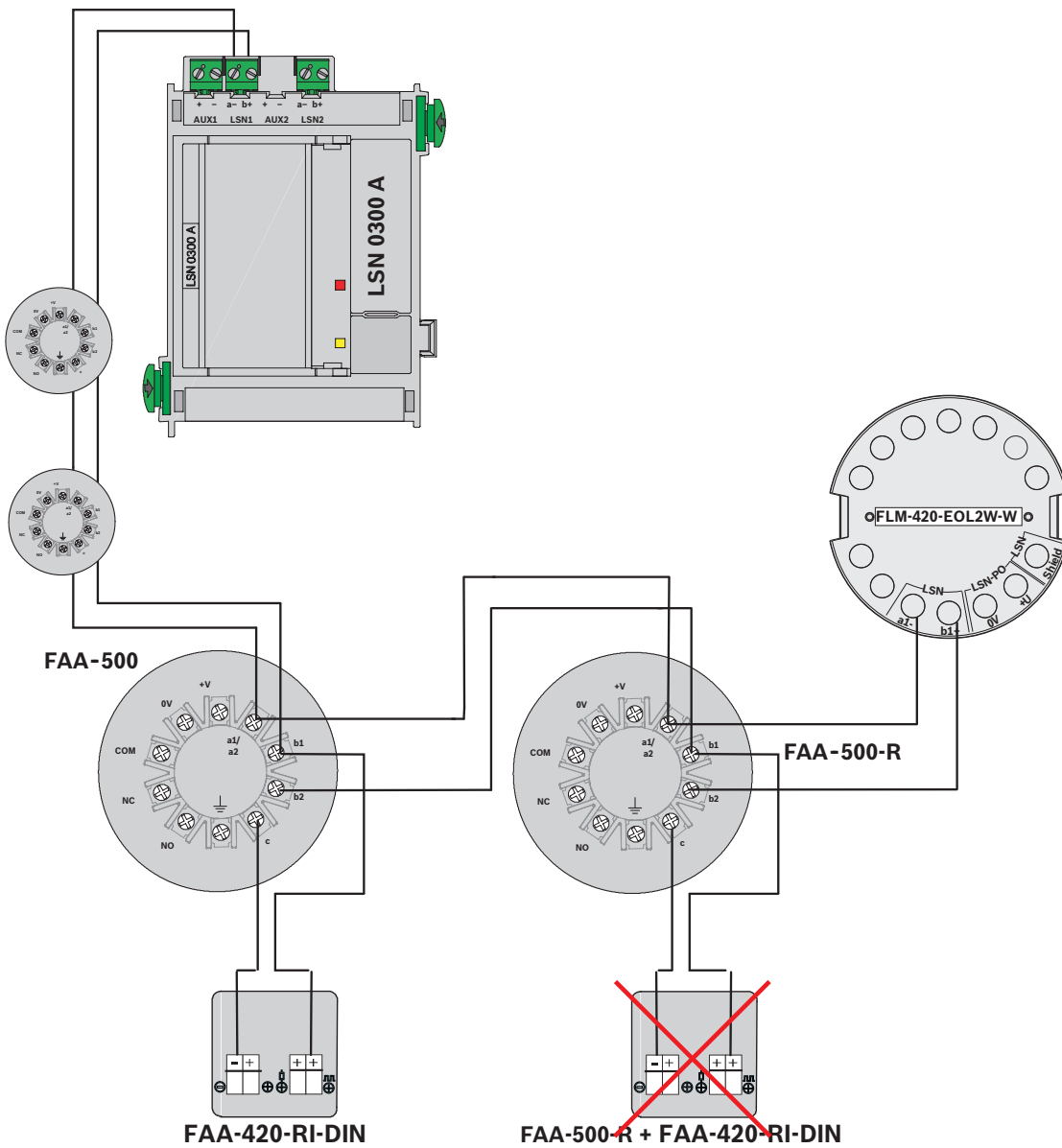

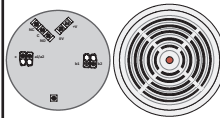

**FAA-MSR-420**  
**FAP-425-O, FAP-425-O-R**  
**FAP-425-OT, FAP-425-OT-R**  
**FAP-425-T-R**  
**FAP-425-DO-R, FAP-425-DOT-R**  
**FAP-425-DOTC-R, FAP-425-DOTCO-R**

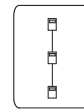

**ELS**

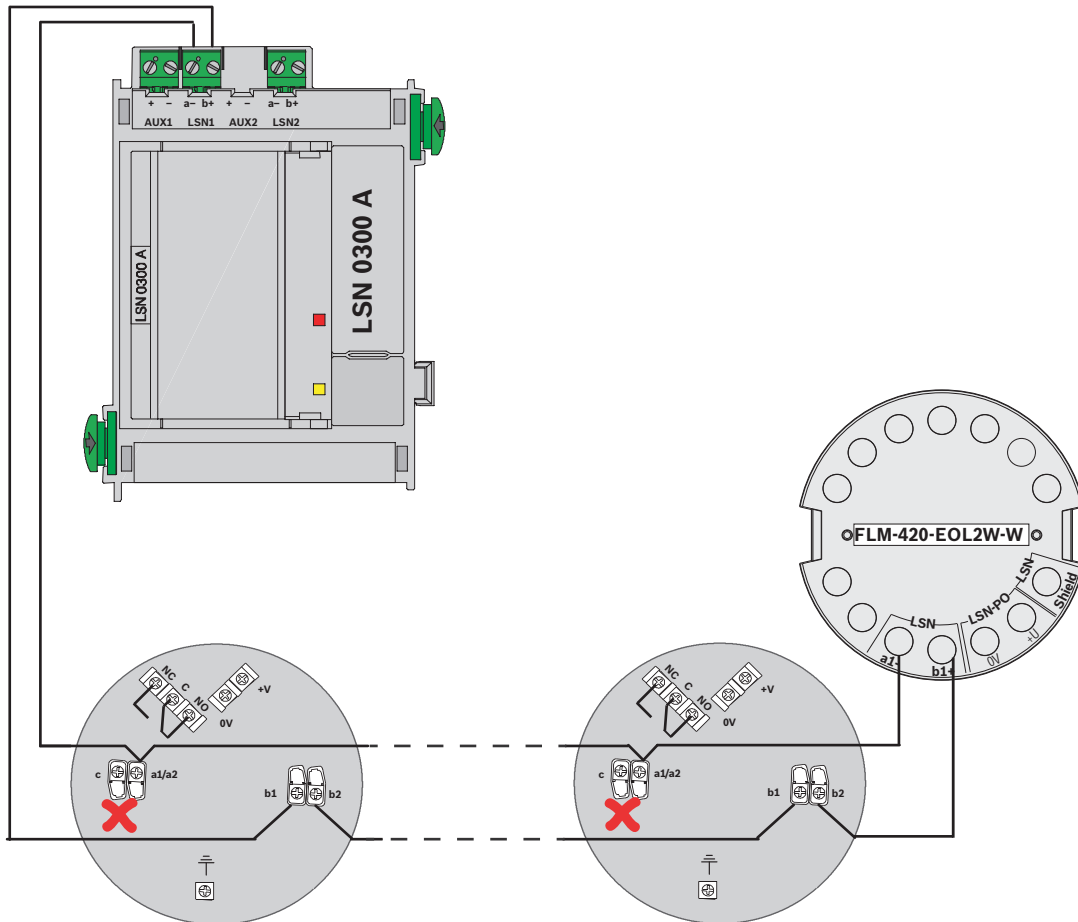

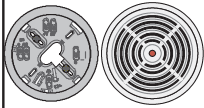

MS 400, MS 400 B  
 FAP-425-O, FAP-425-O-R  
 FAP-425-OT, FAP-425-OT-R  
 FAP-425-T-R  
 FAP-425-DO-R, FAP-425-DOT-R  
 FAP-425-DOTC-R, FAP-425-DOTCO-R



ELS

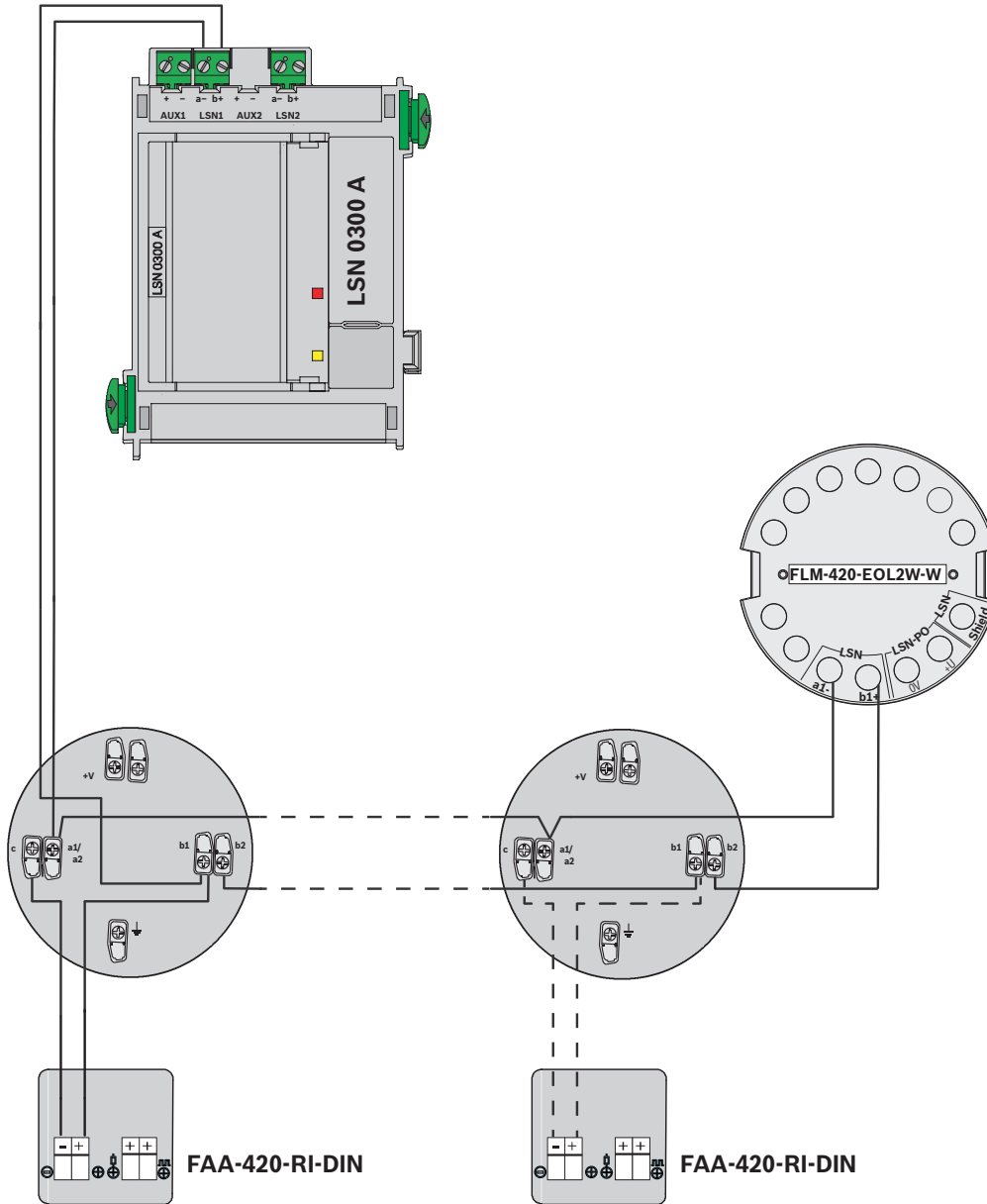

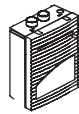

FAS-420 Series

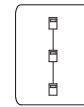

ELS

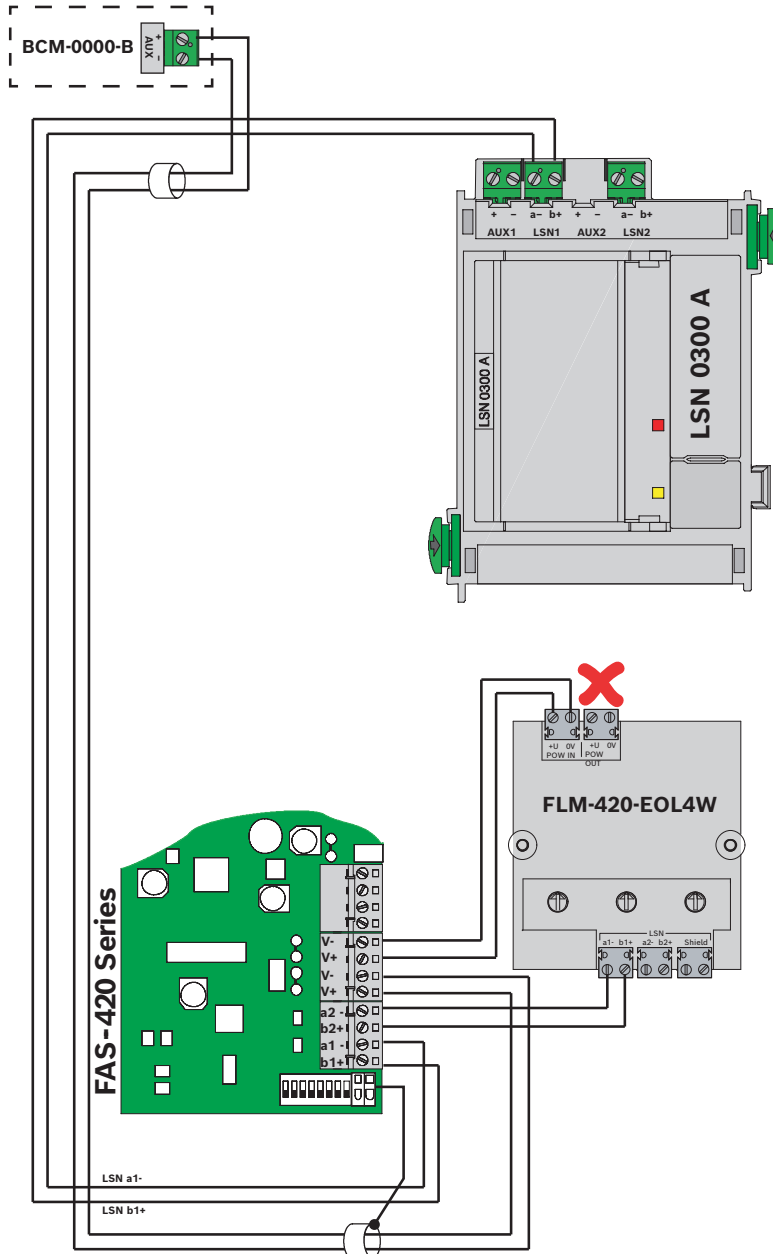

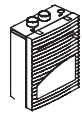

FAS-420 Series

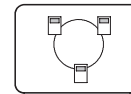

ELS

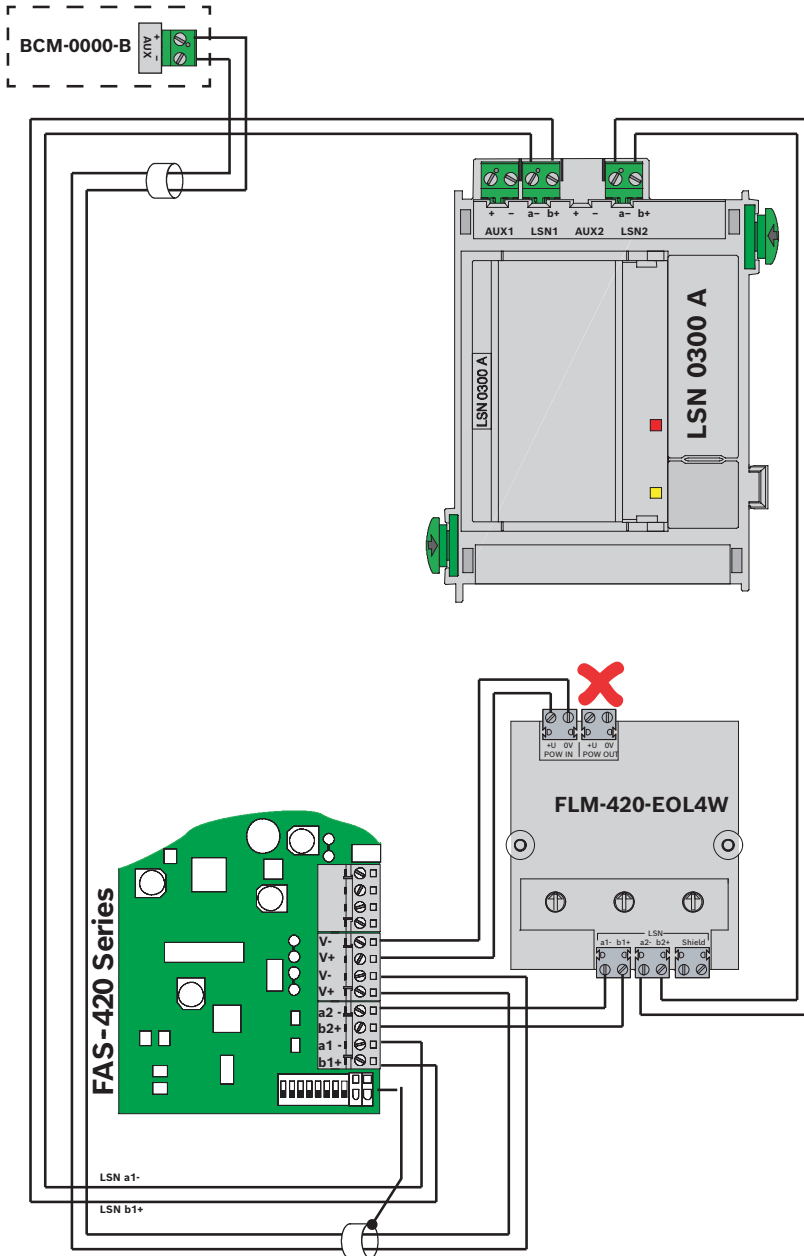



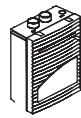

FAS-420-TM Series

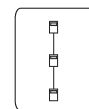

ELS

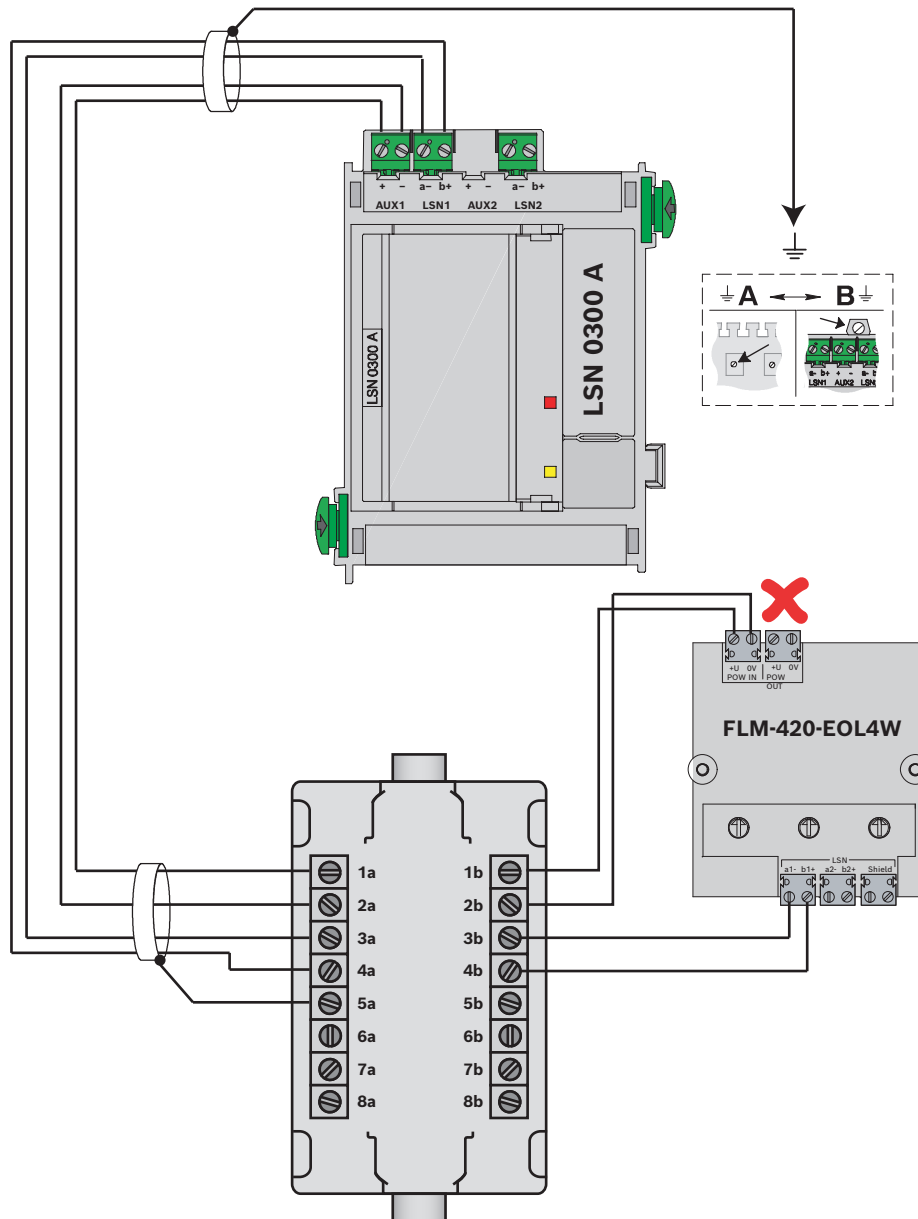

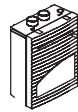

FAS-420-TM Series

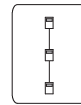

ELS

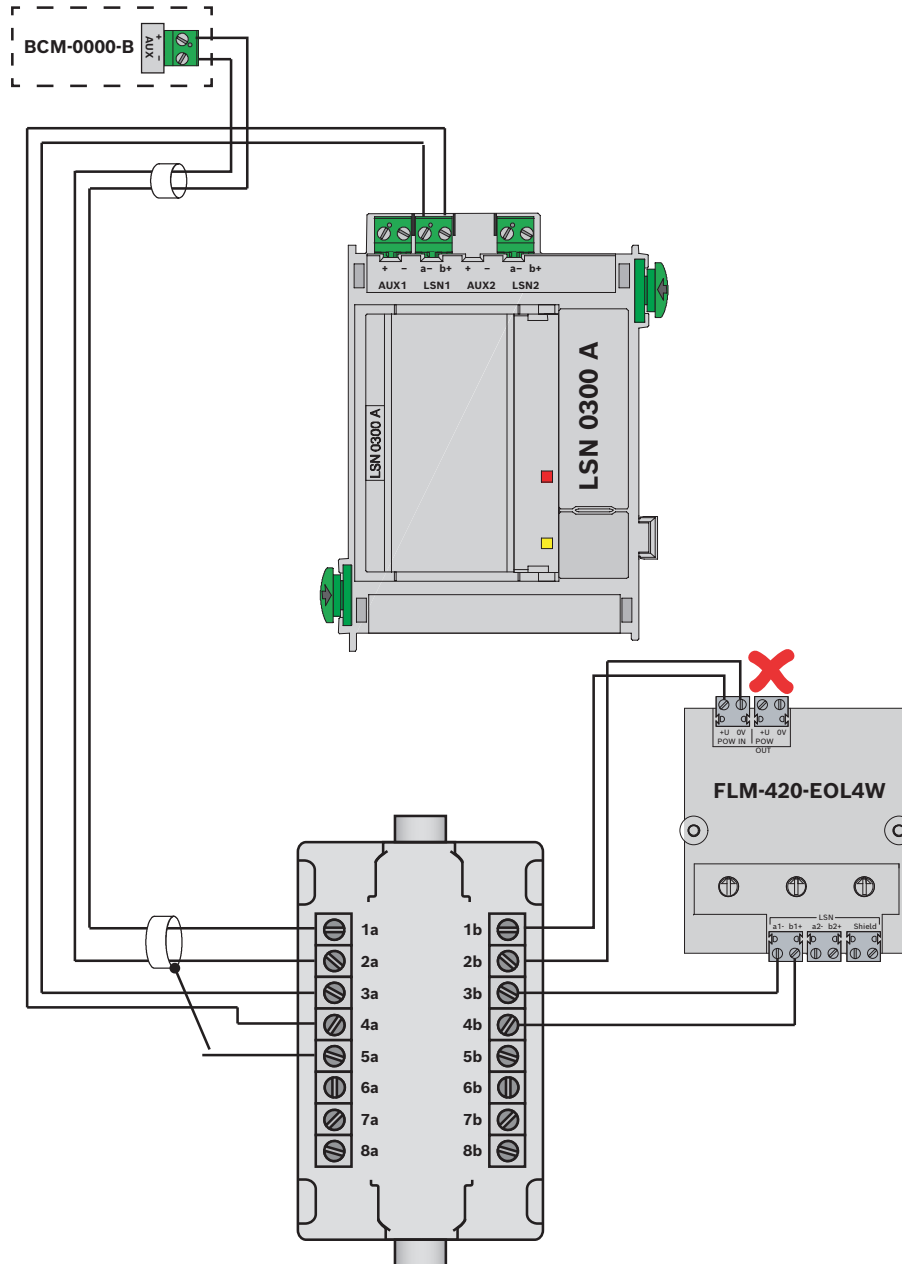

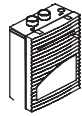

FAS-420-TM Series

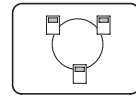

ELS

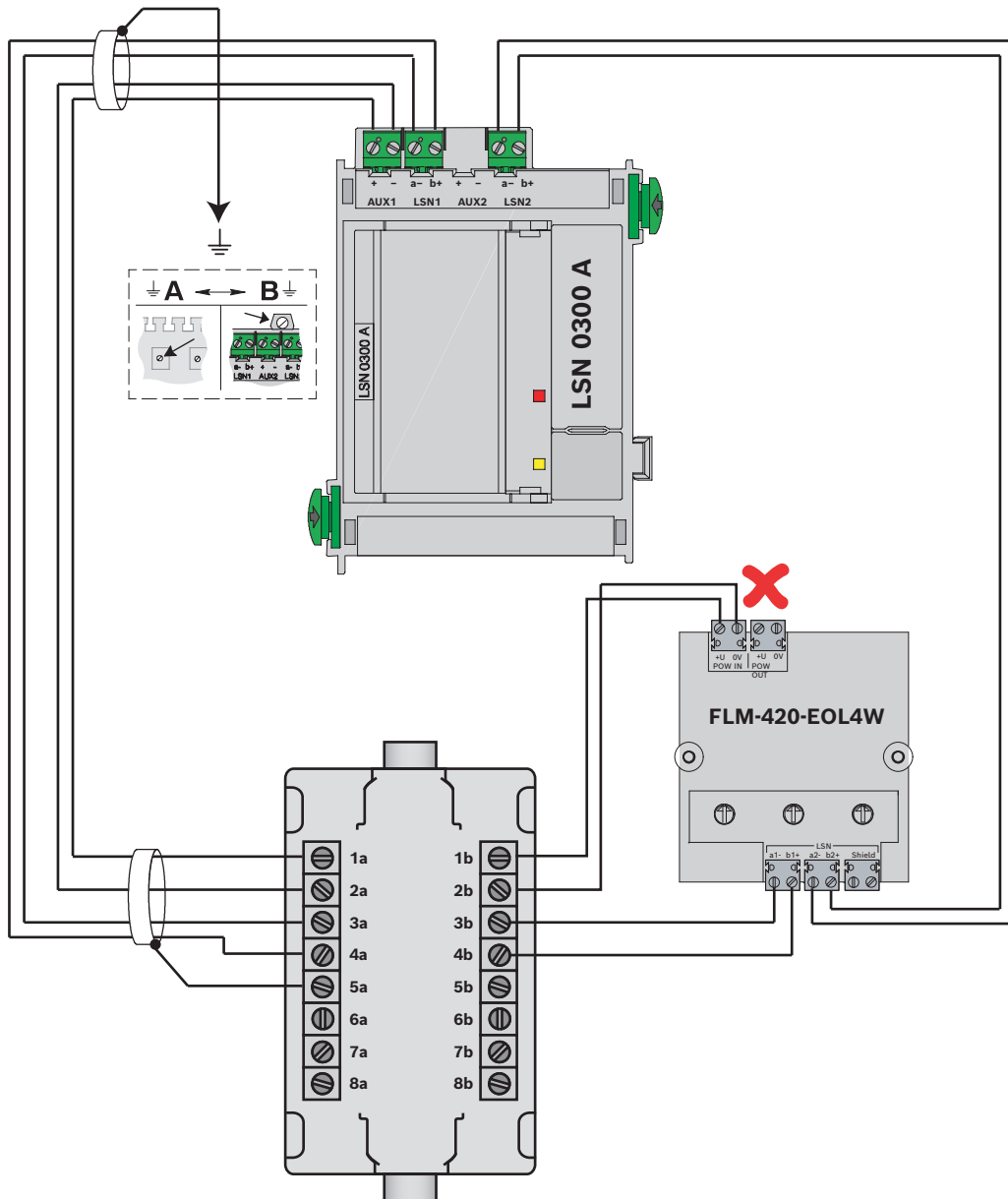

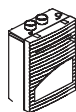

FAS-420-TM Series

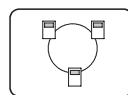

ELS

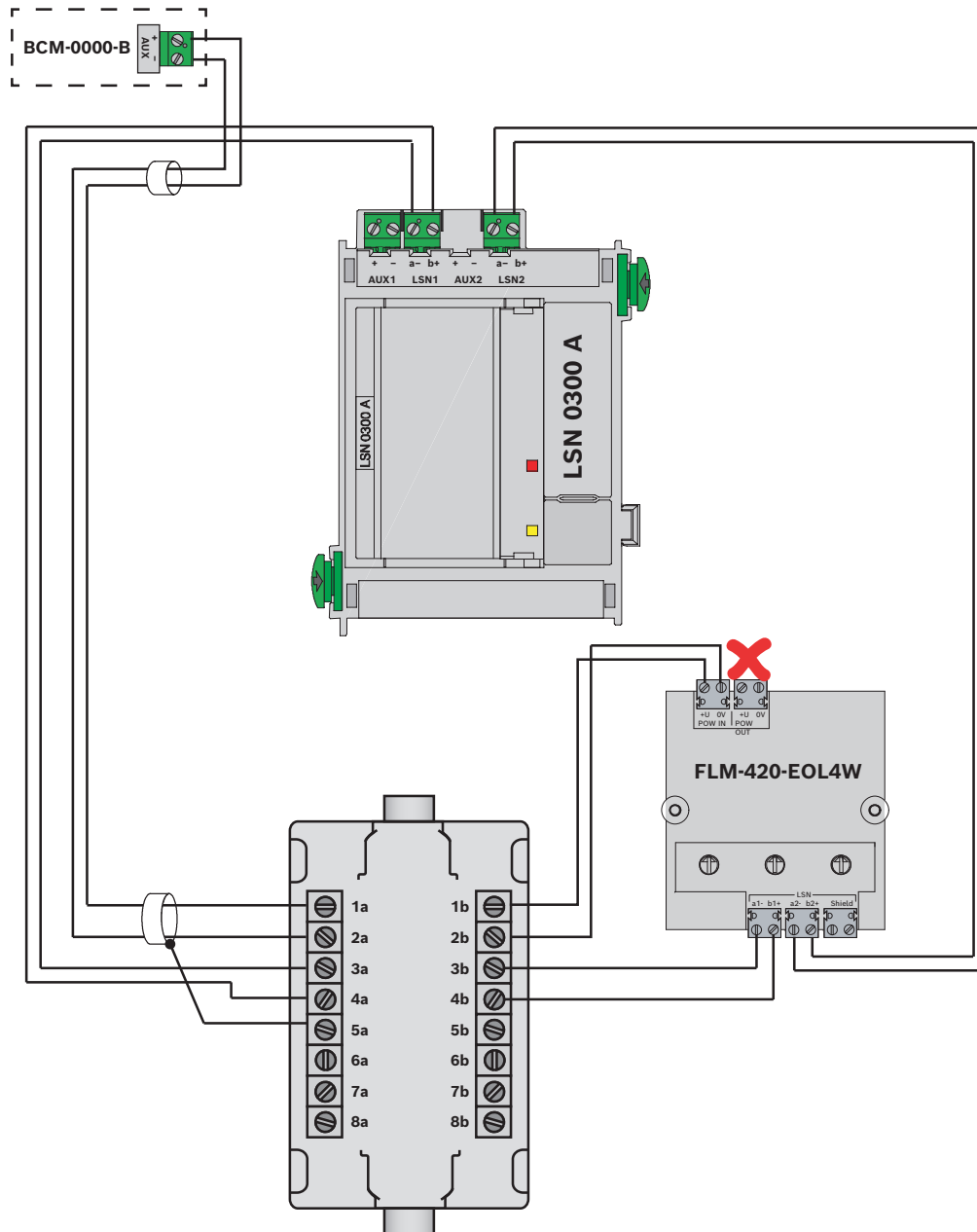



**FBF 100 LSN**

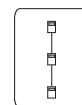

**ELS**

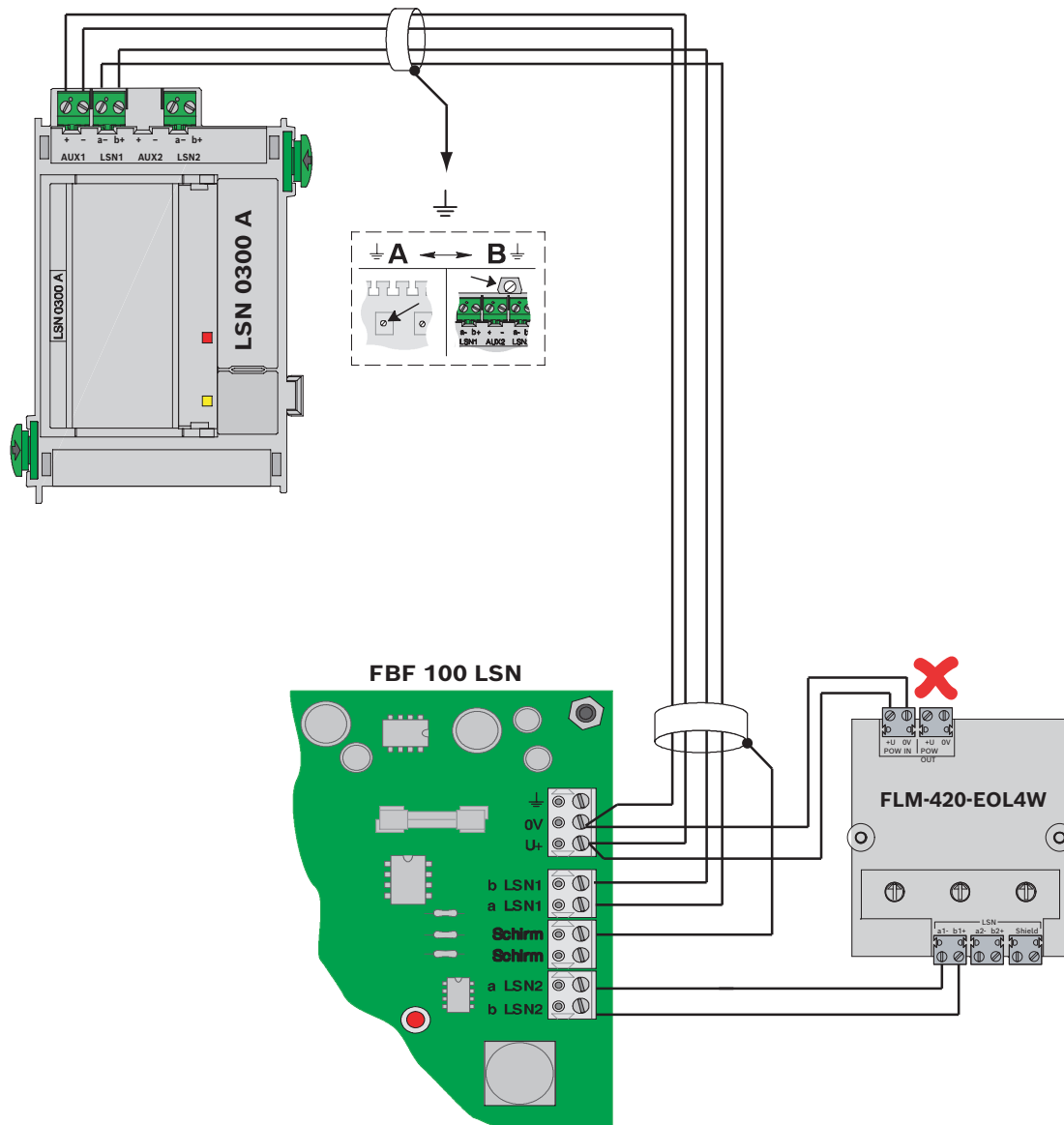



FBF 100 LSN

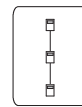

ELS

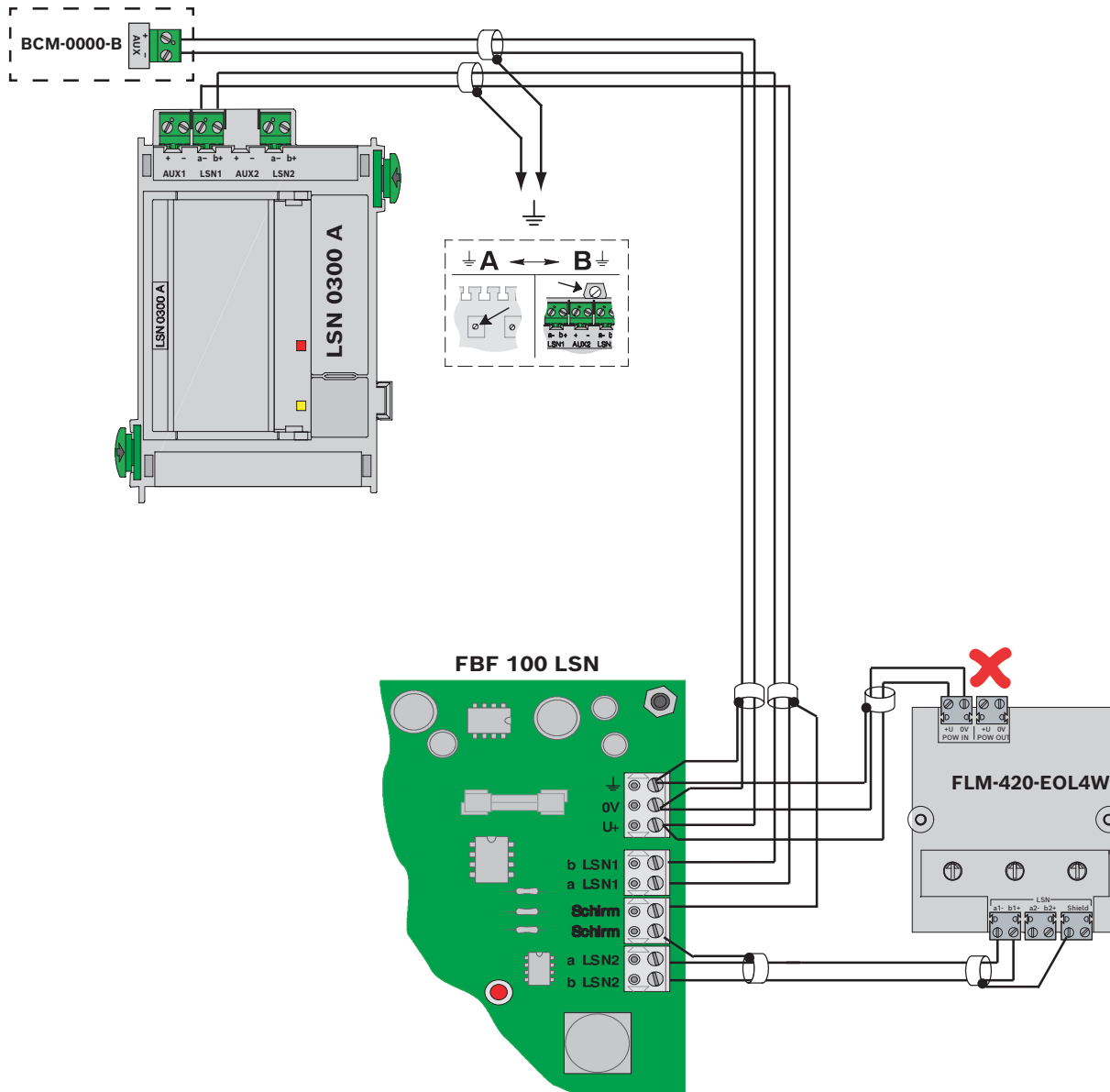



FBF 100 LSN

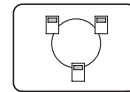

ELS

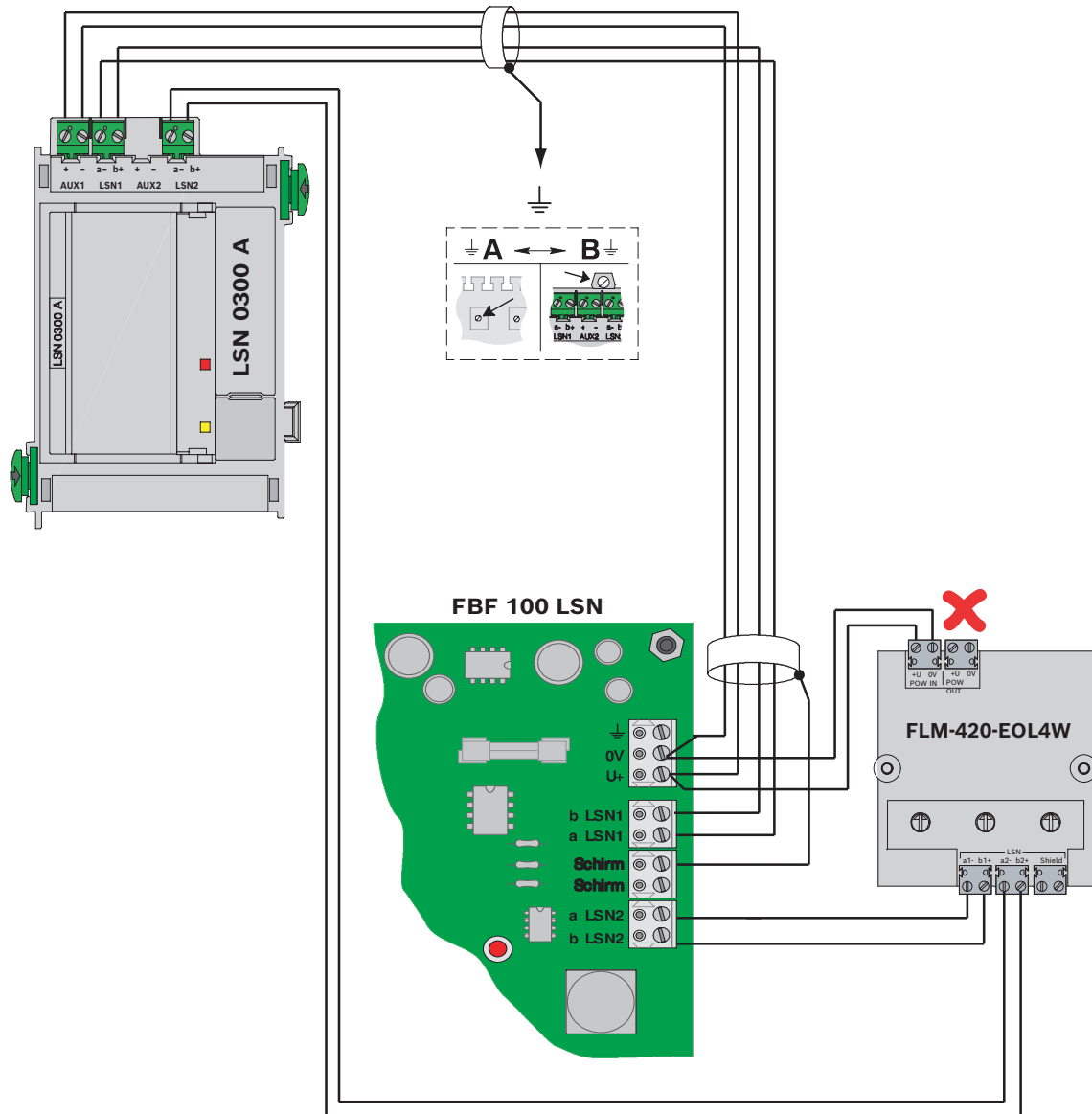



**FBF 100 LSN**

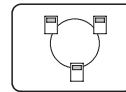

**ELS**

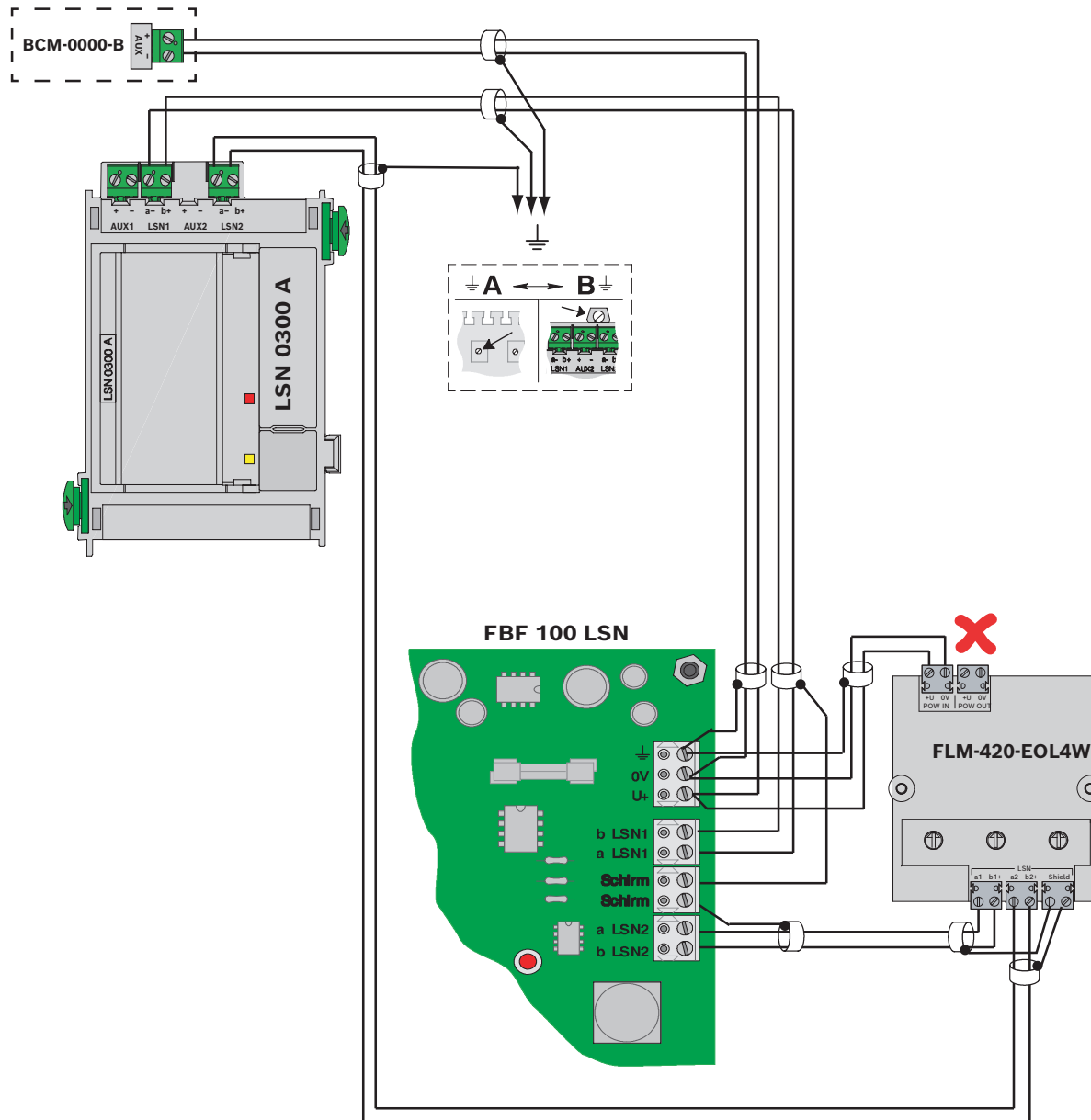



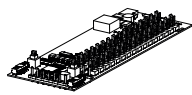

ATB 420 LSNi

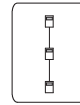

ELS

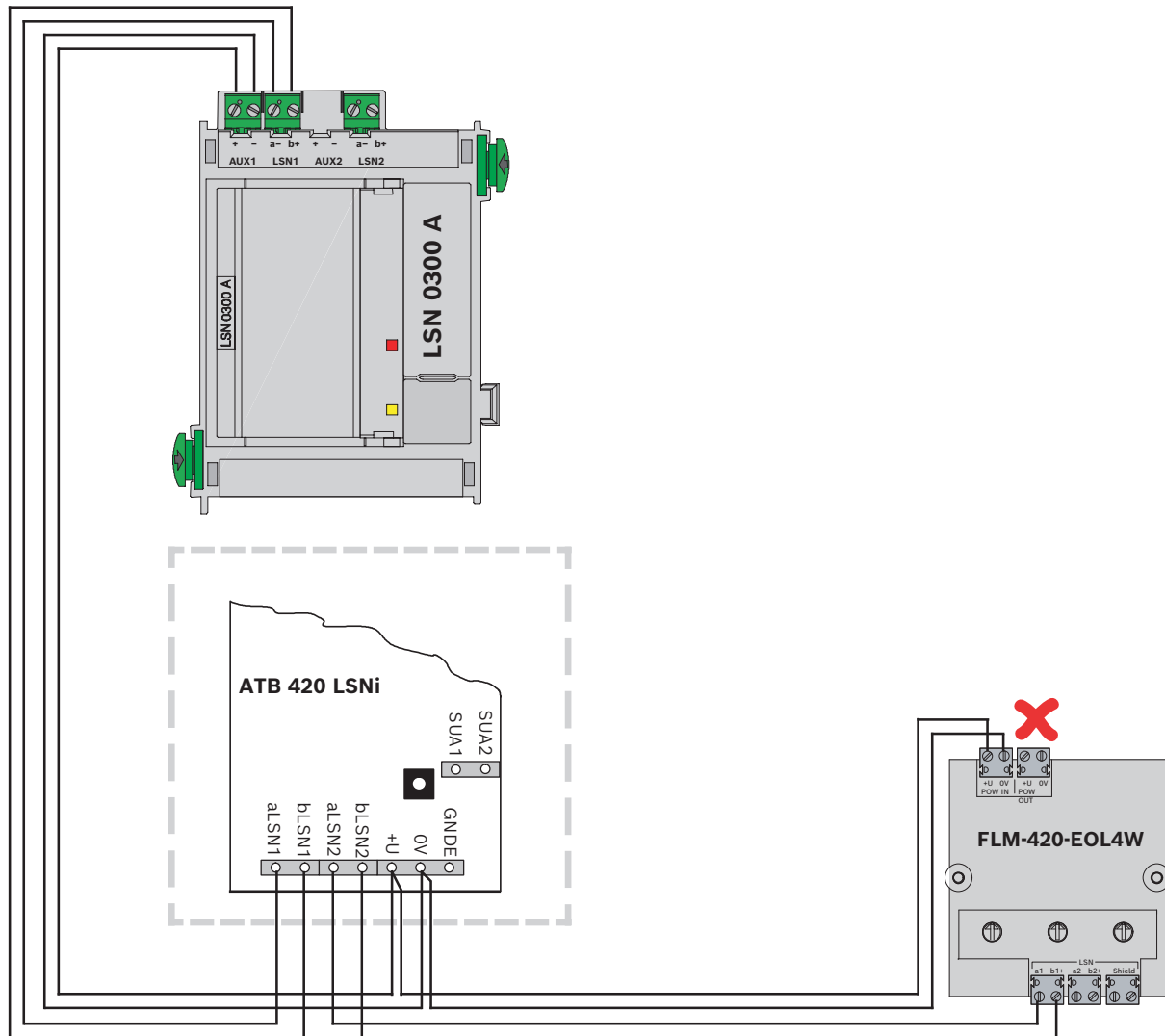

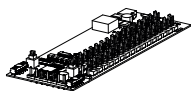

ATB 420 LSNi

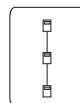

ELS

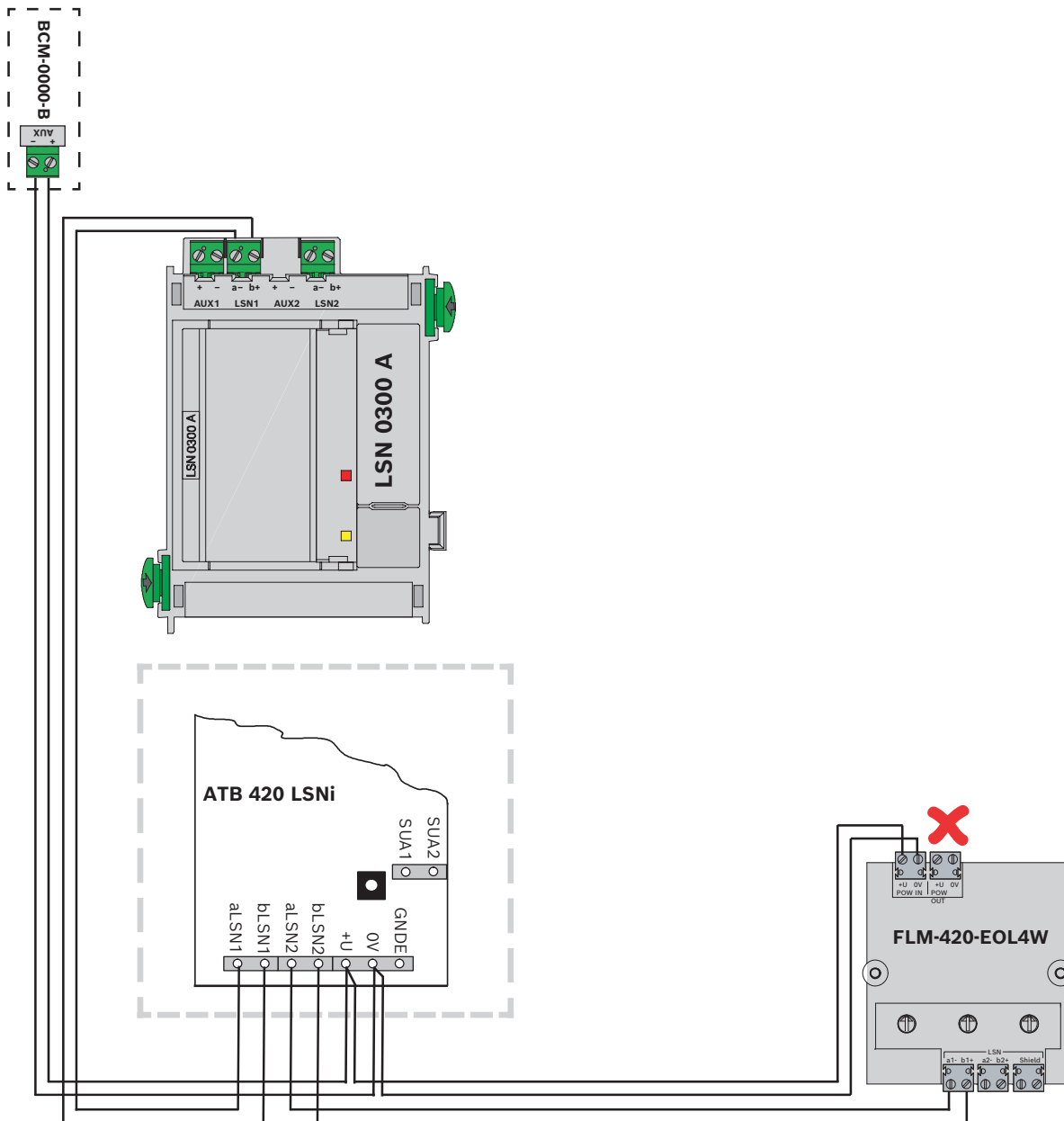

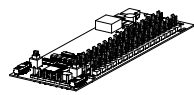

ATB 420 LSNi

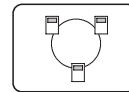

ELS

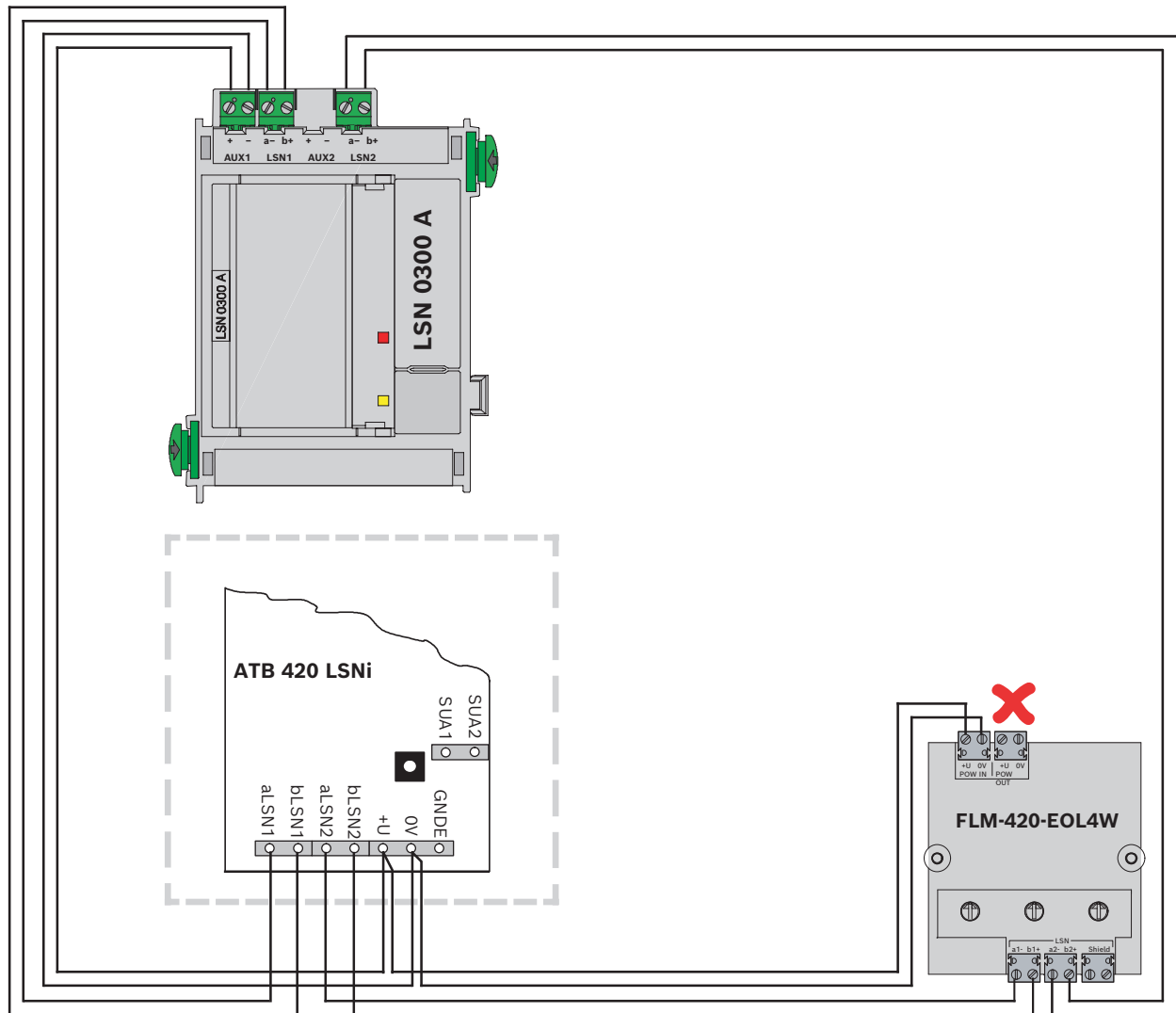

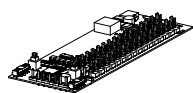

ATB 420 LSNi

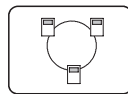

ELS

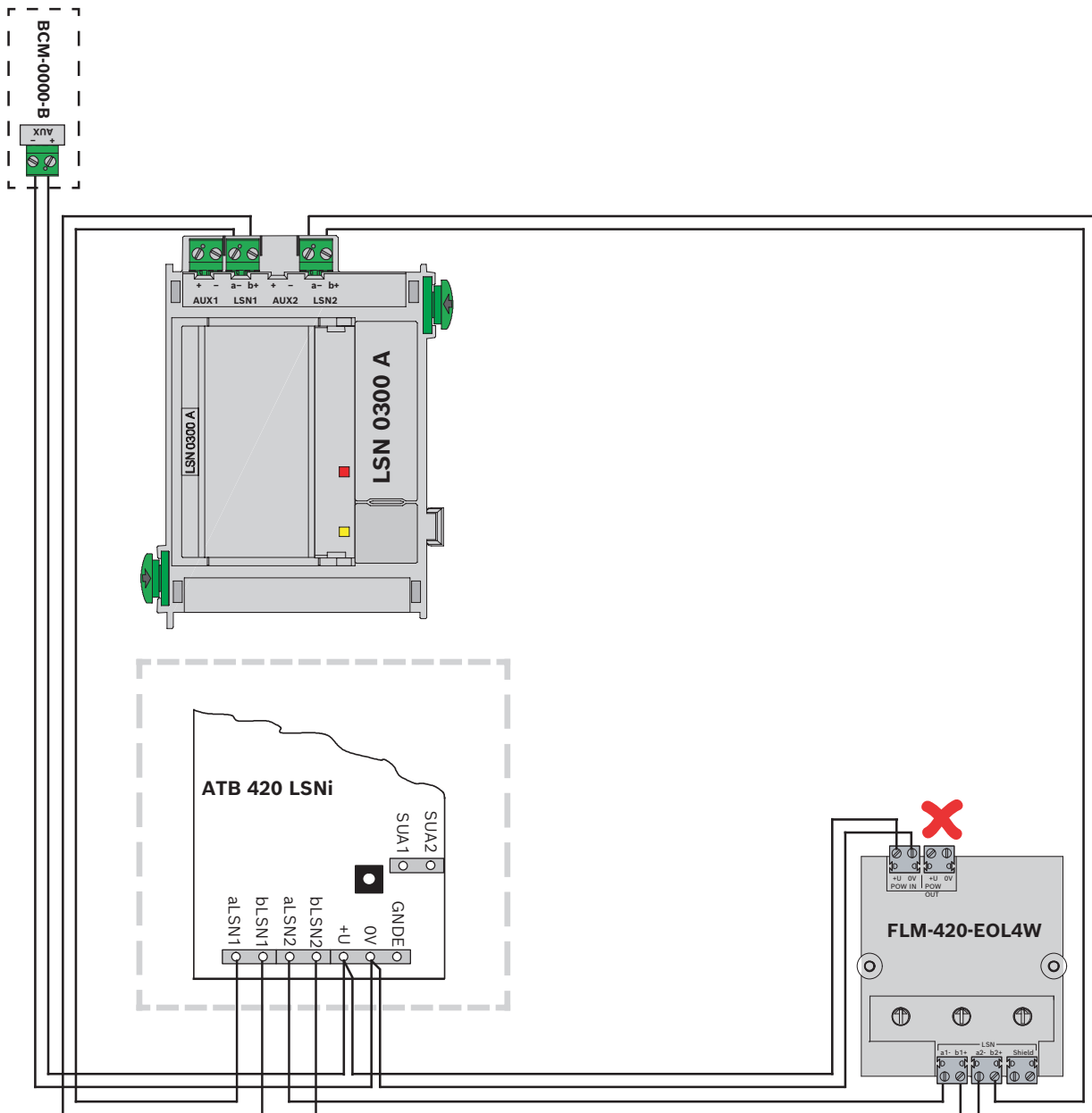



**BAT 100 LSN  
ATG 420 LSNi**

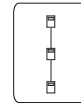

**ELS**

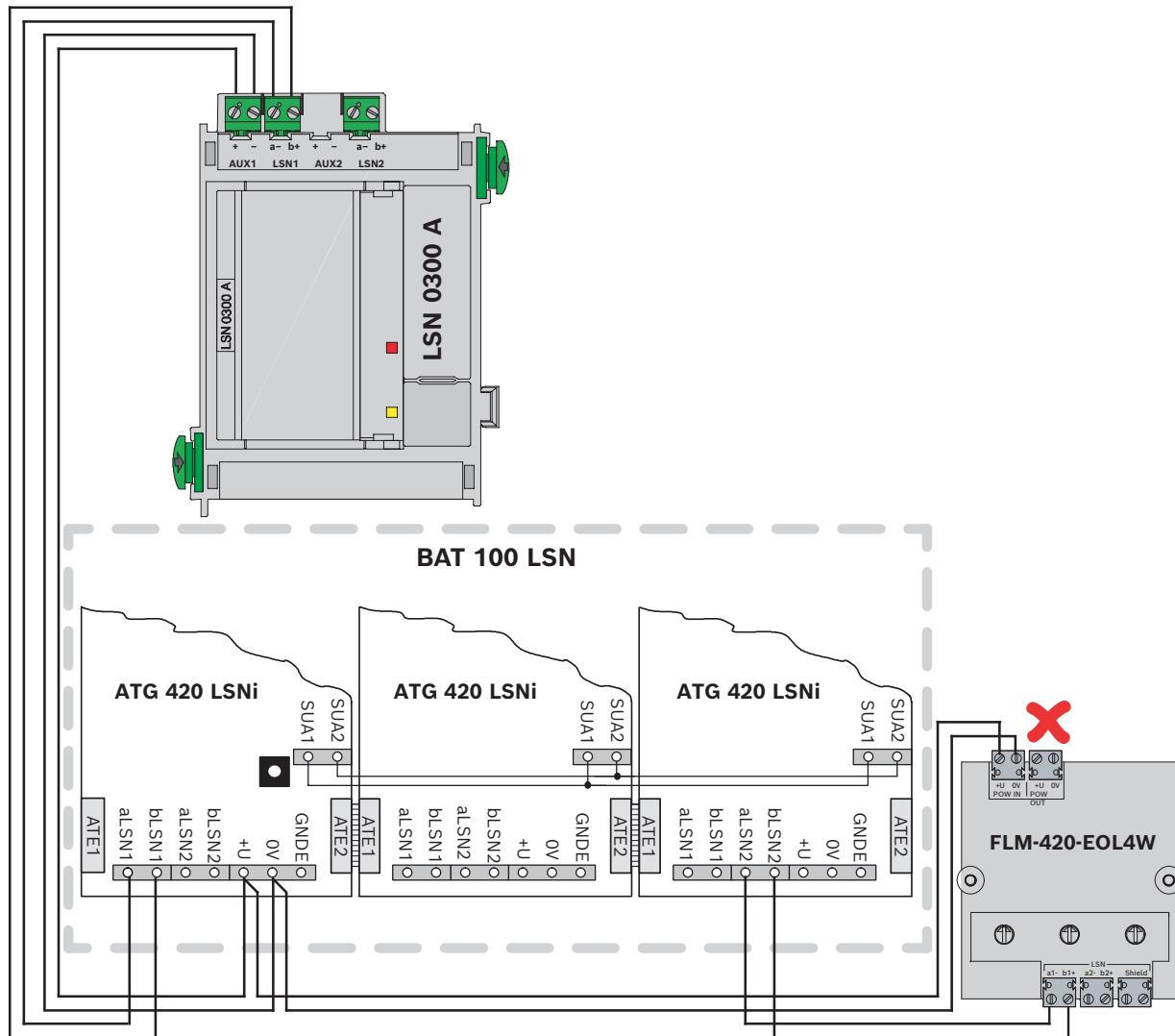



**BAT 100 LSN  
ATG 420 LSNi**

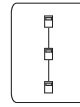

**ELS**

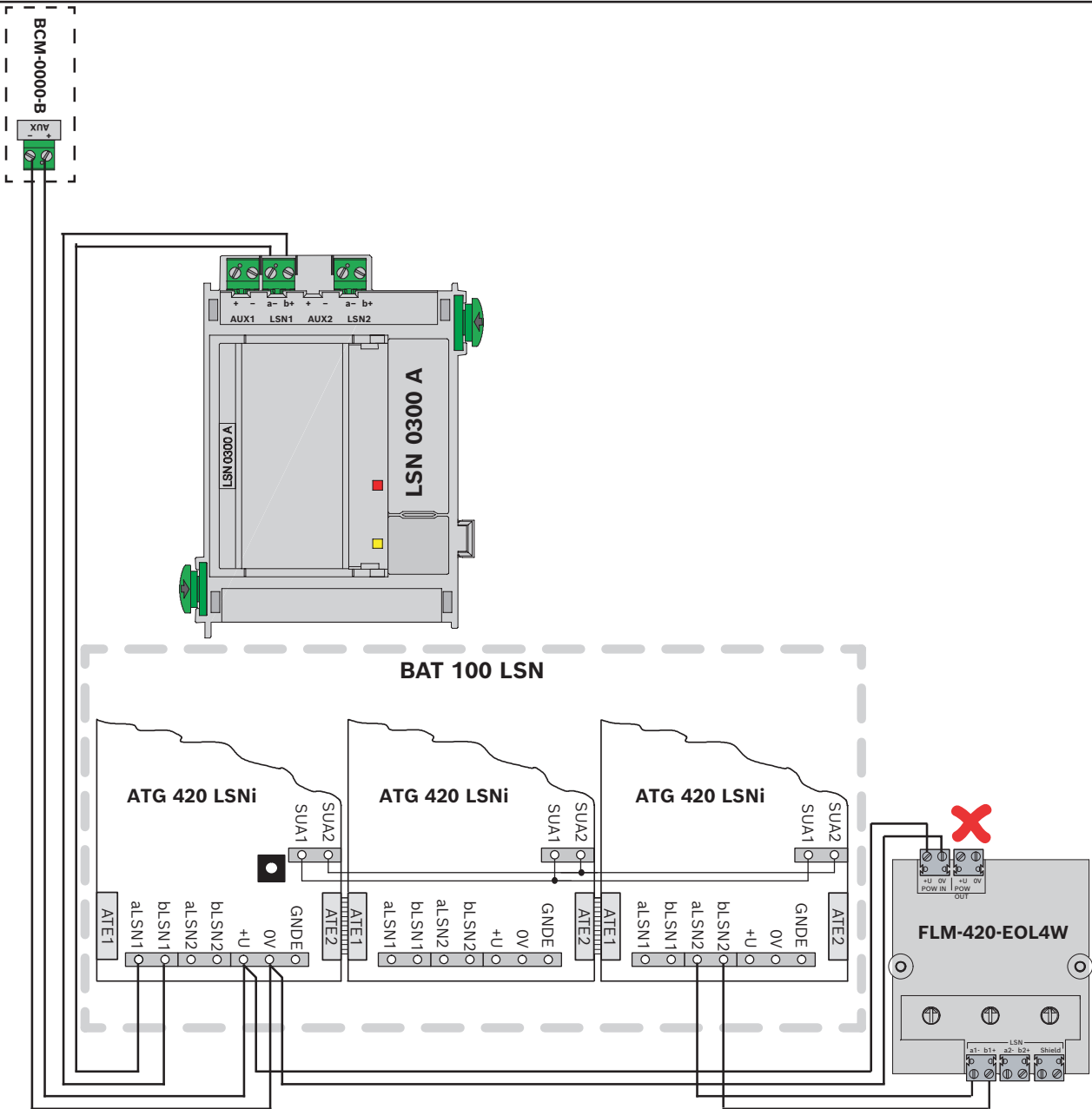



**BAT 100 LSN  
ATG 420 LSNi**

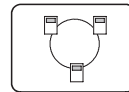

**ELS**

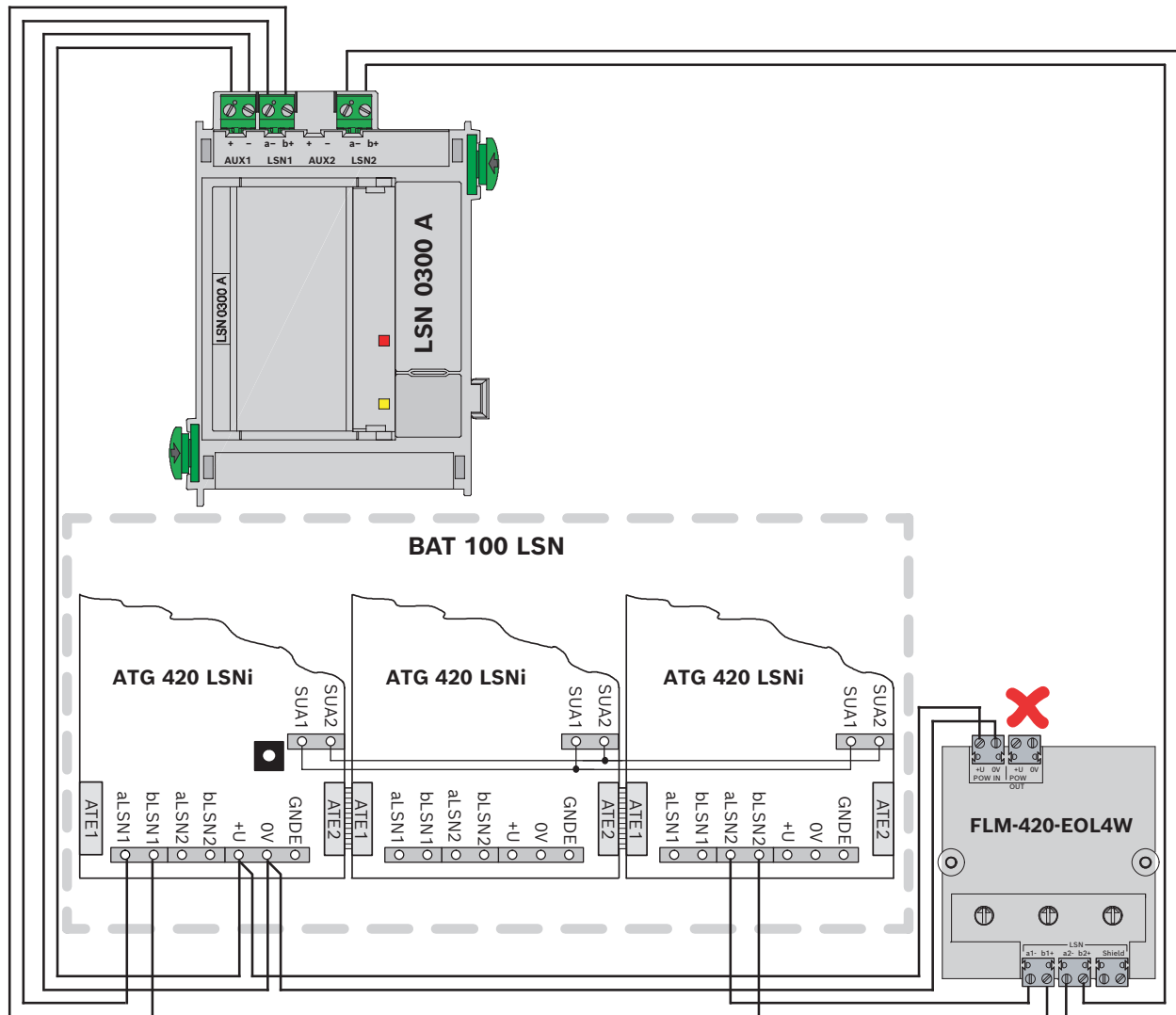



BAT 100 LSN  
ATG 420 LSNi

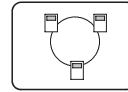

ELS

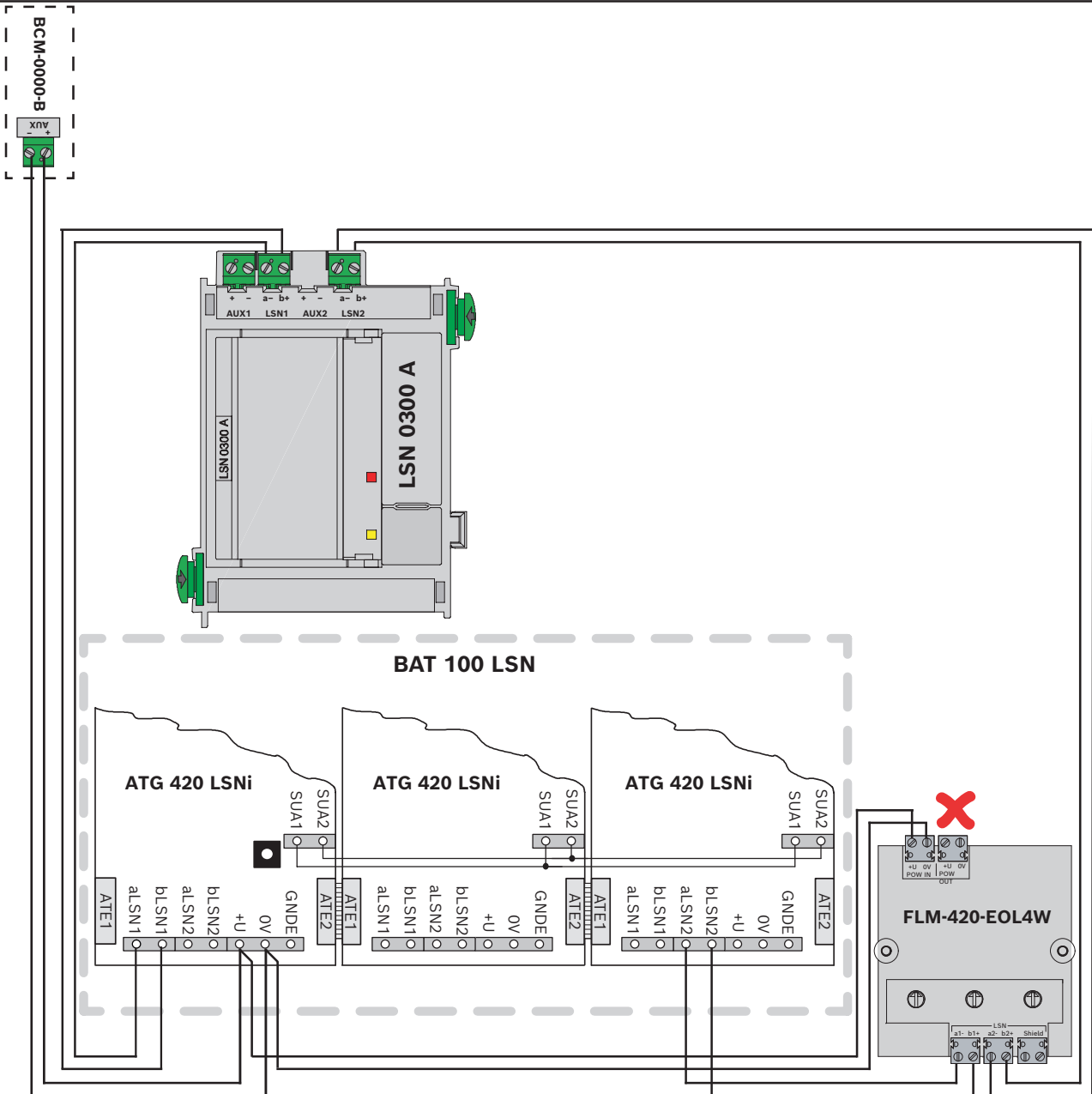





**FNX-425U-WFWH**  
**FNX-425U-RFWH**  
**FNX-425U-WFRD**  
**FNX-425U-RFRD**



**ELS**

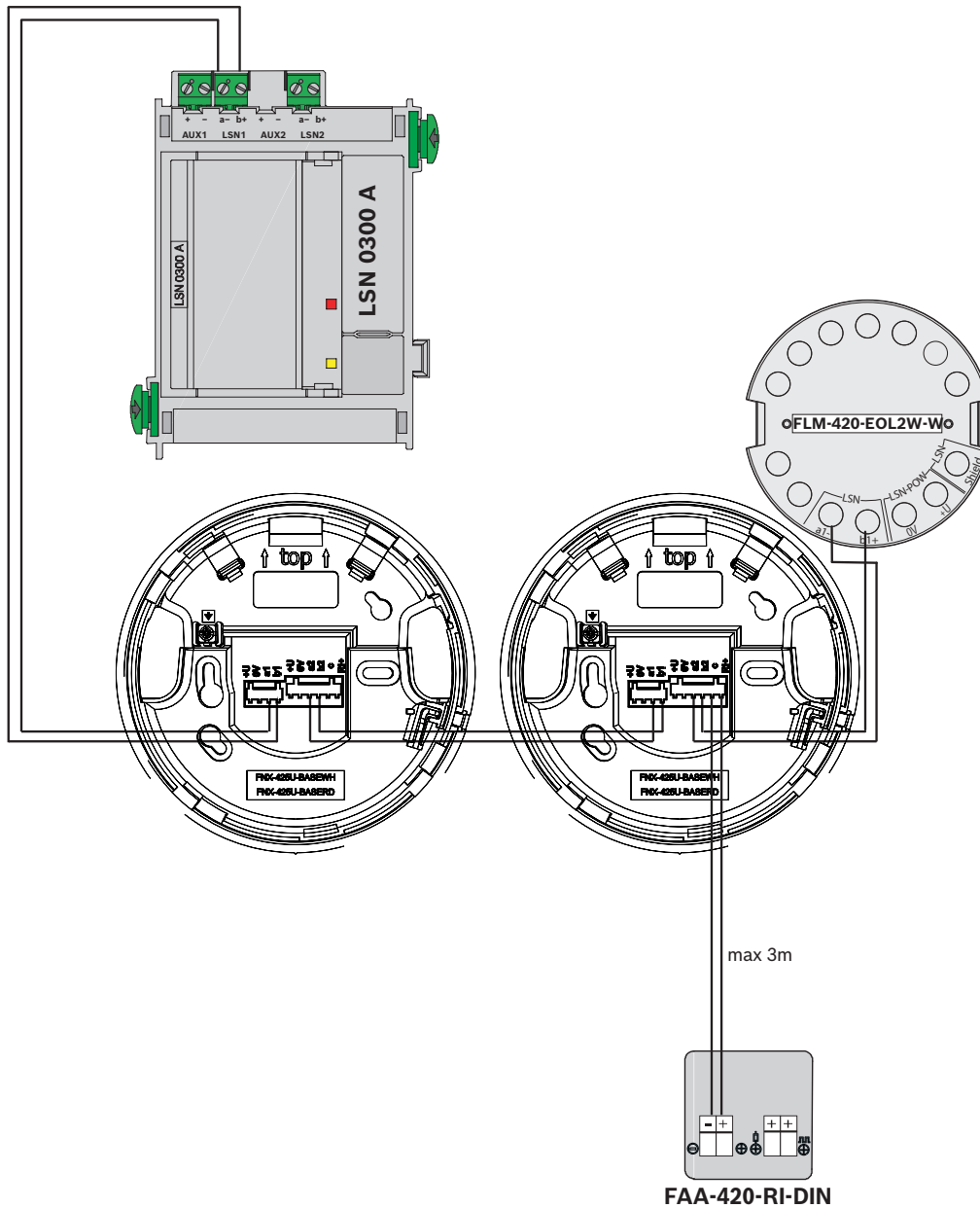



FNX-425U-WFWH  
 FNX-425U-RFWH  
 FNX-425U-WFRD  
 FNX-425U-RFRD

+

FNX-425U-COVWH  
 FNX-425U-COVRD



ELS

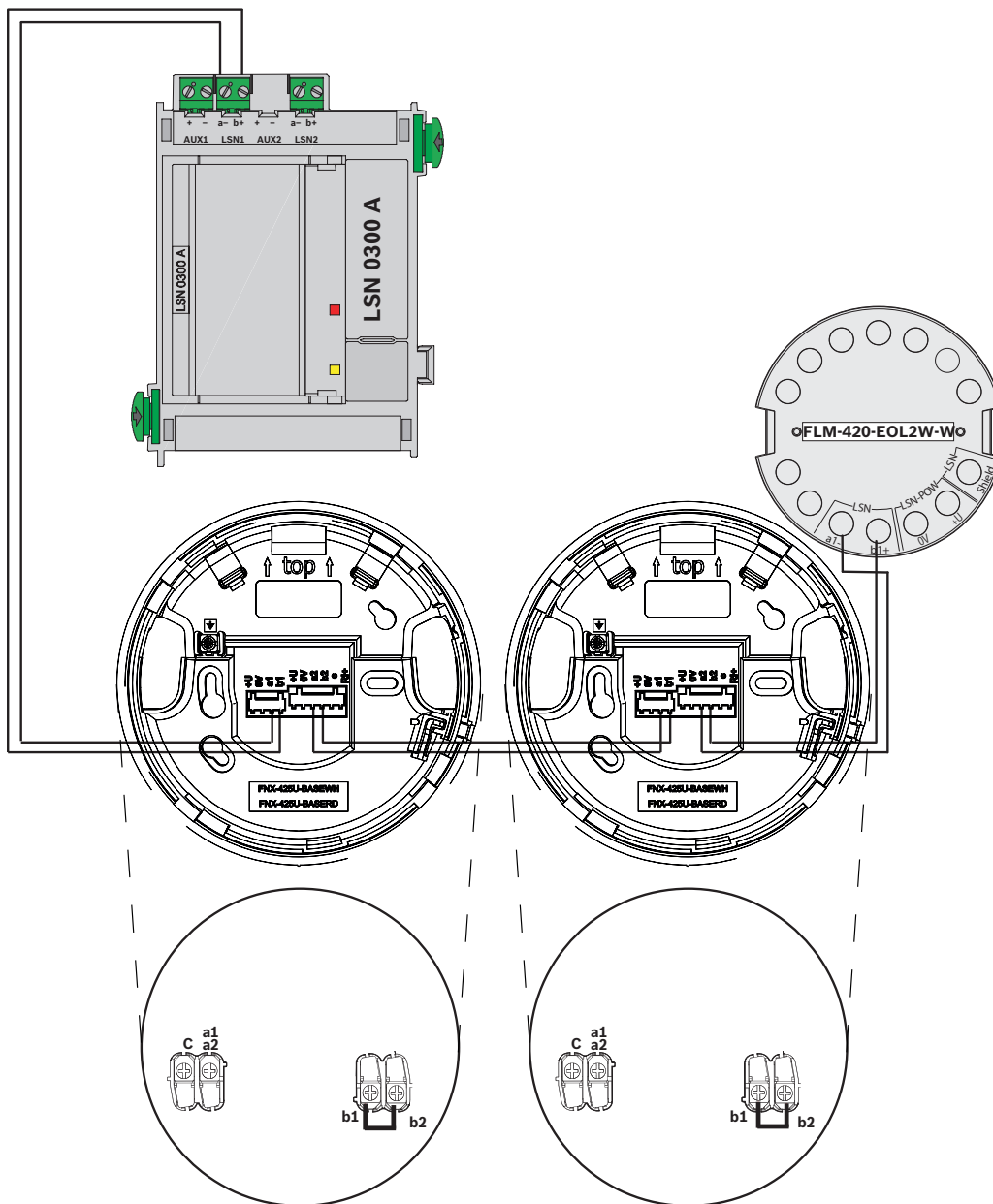

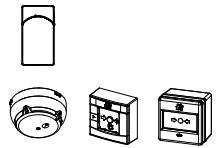

**FWI-270**

**FDOOT271-O**  
**FDM275-O**  
**FDM273-O**

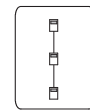

**ELS**

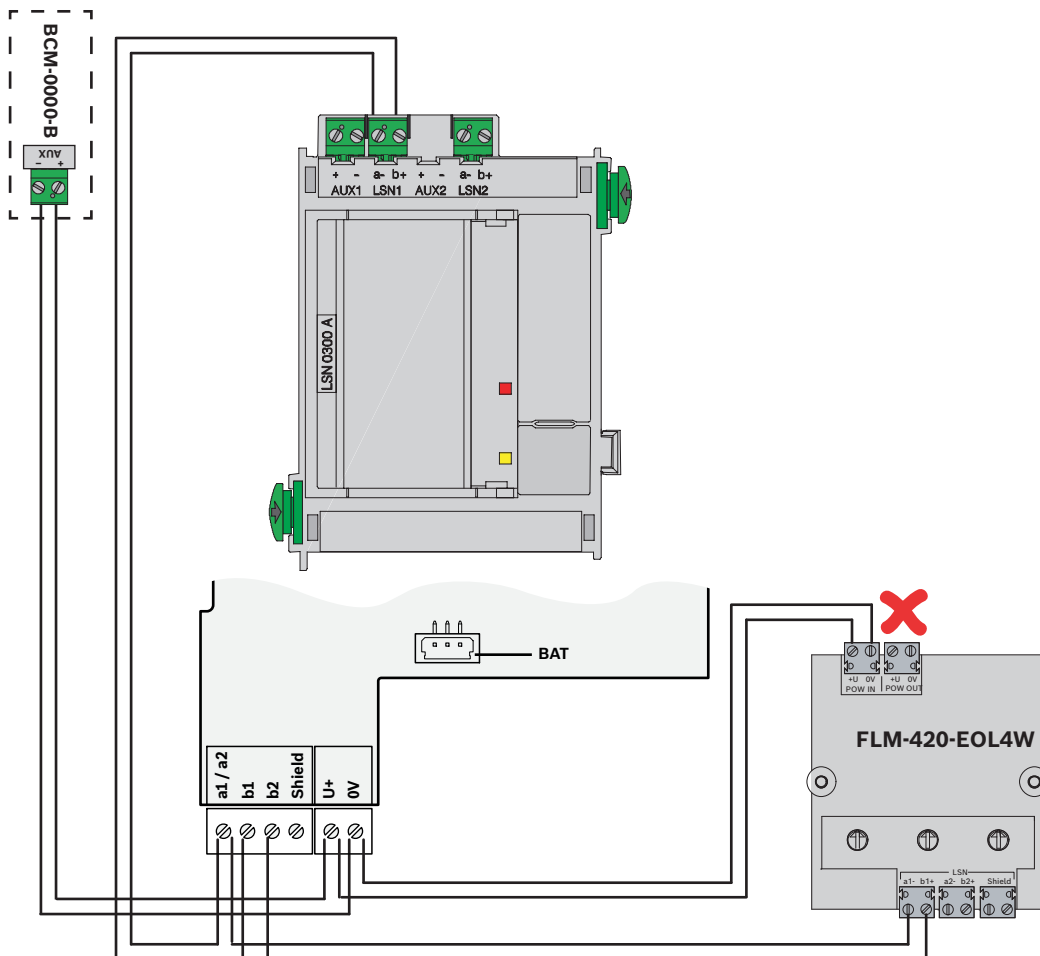



**FWI-270**

**FDOOT271-O**  
**FDM275-O**  
**FDM273-O**

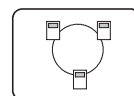

**ELS**

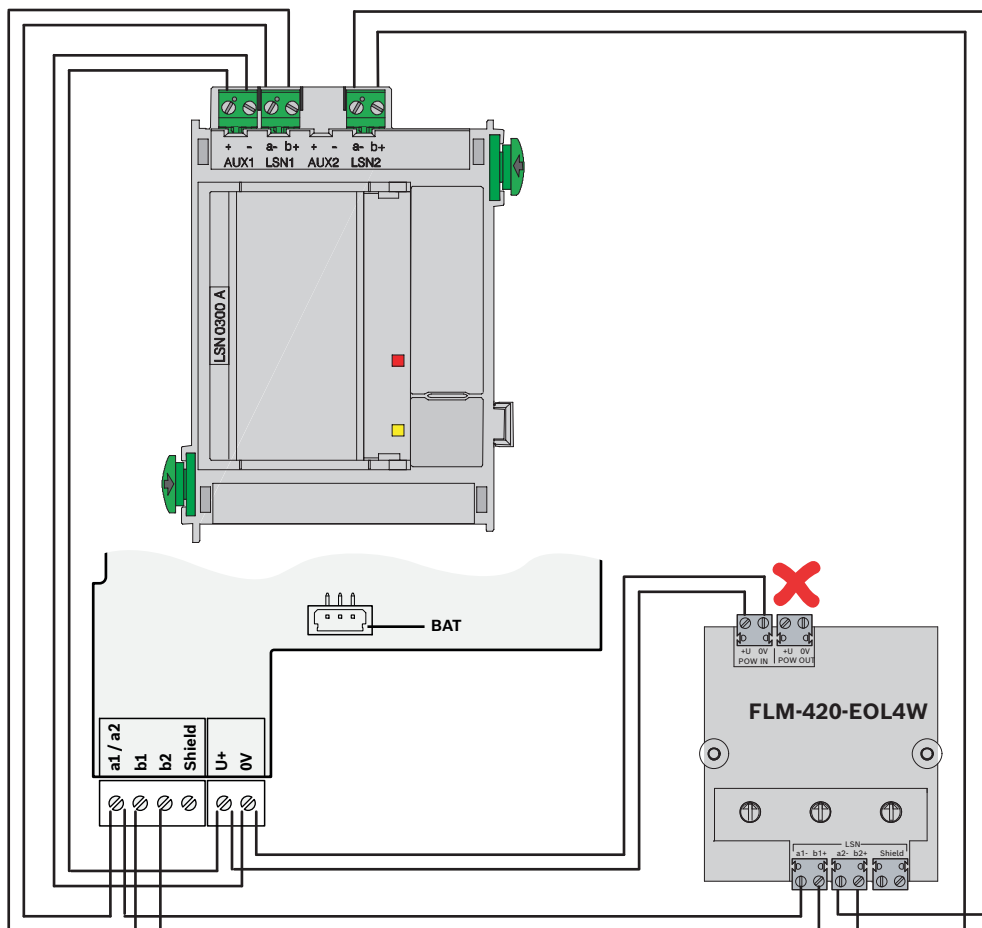

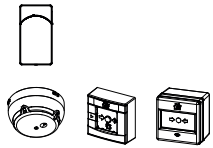

**FWI-270**

**FDOOT271-O**  
**FDM275-O**  
**FDM273-O**

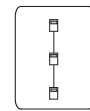

**ELS**

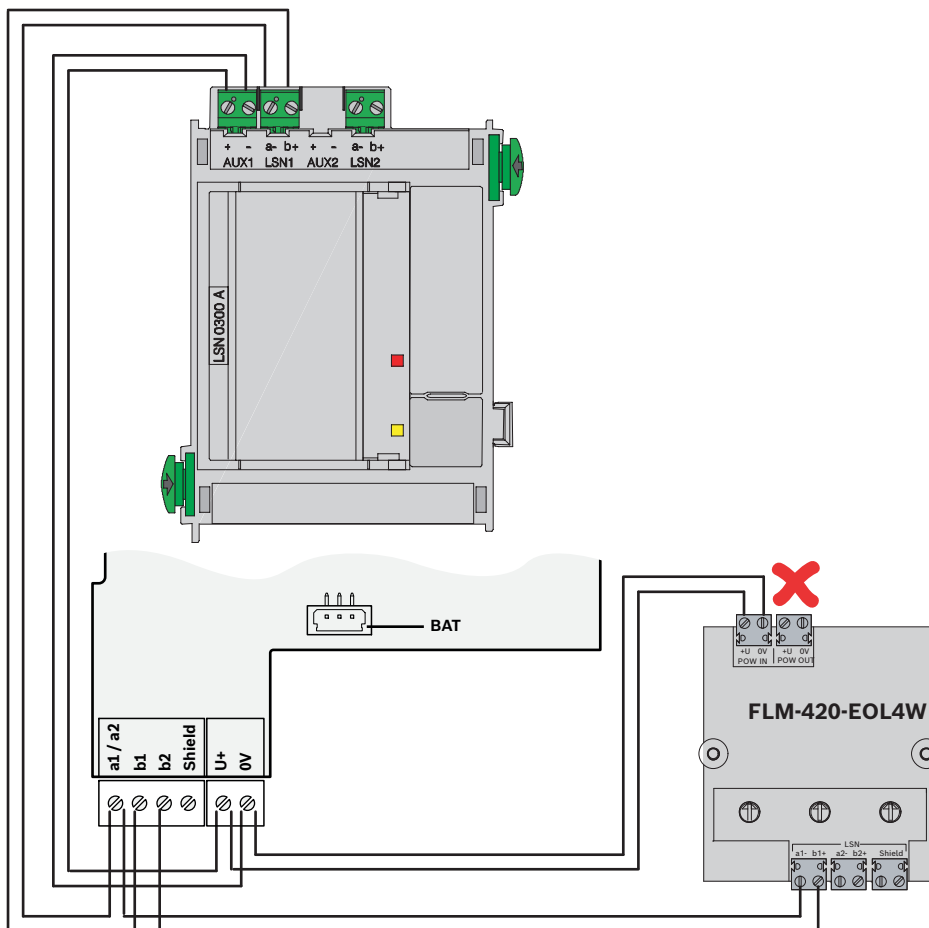

### 2.6.3 FLM-420/4-CON-S/D

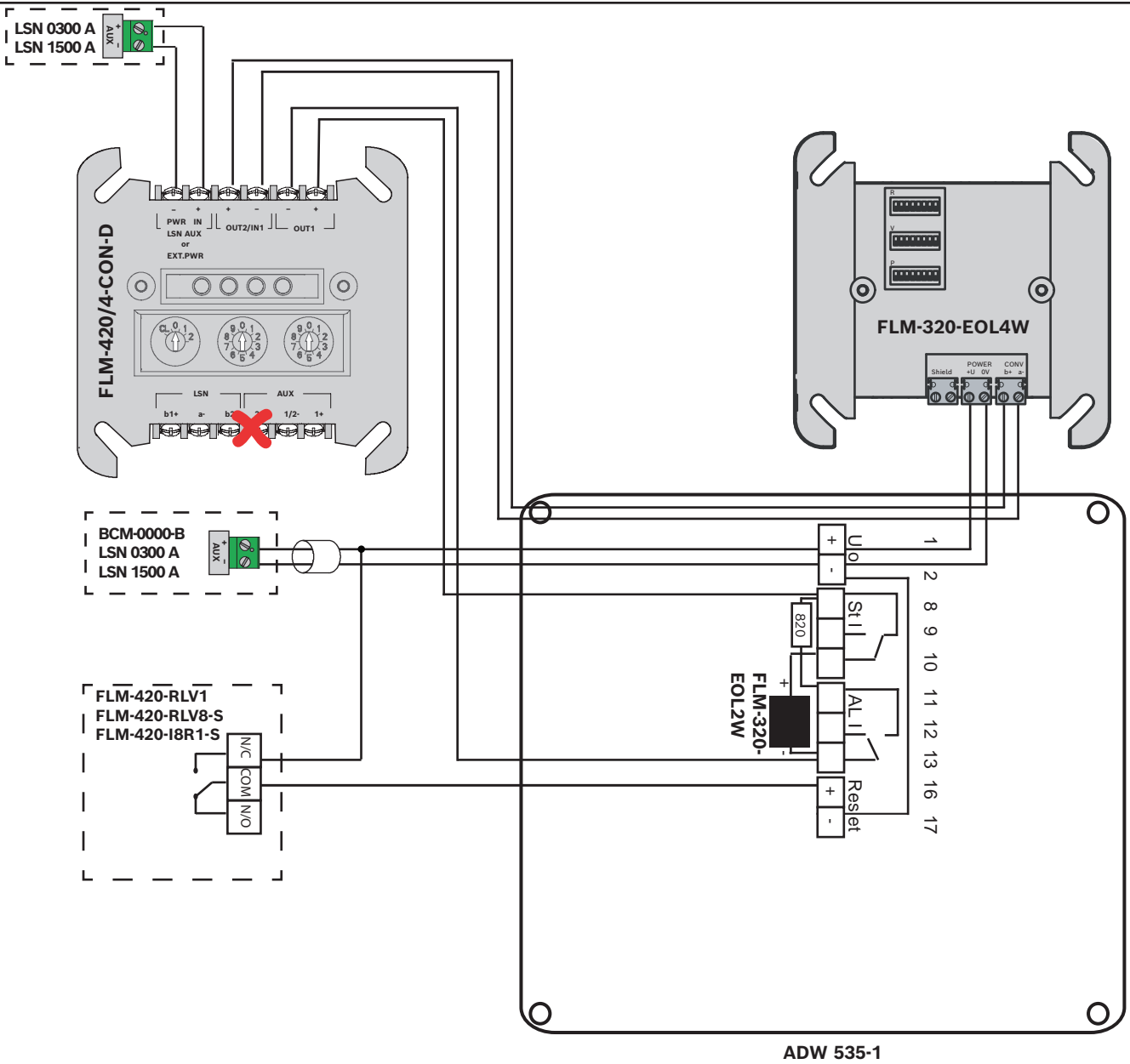
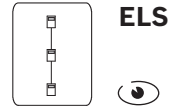

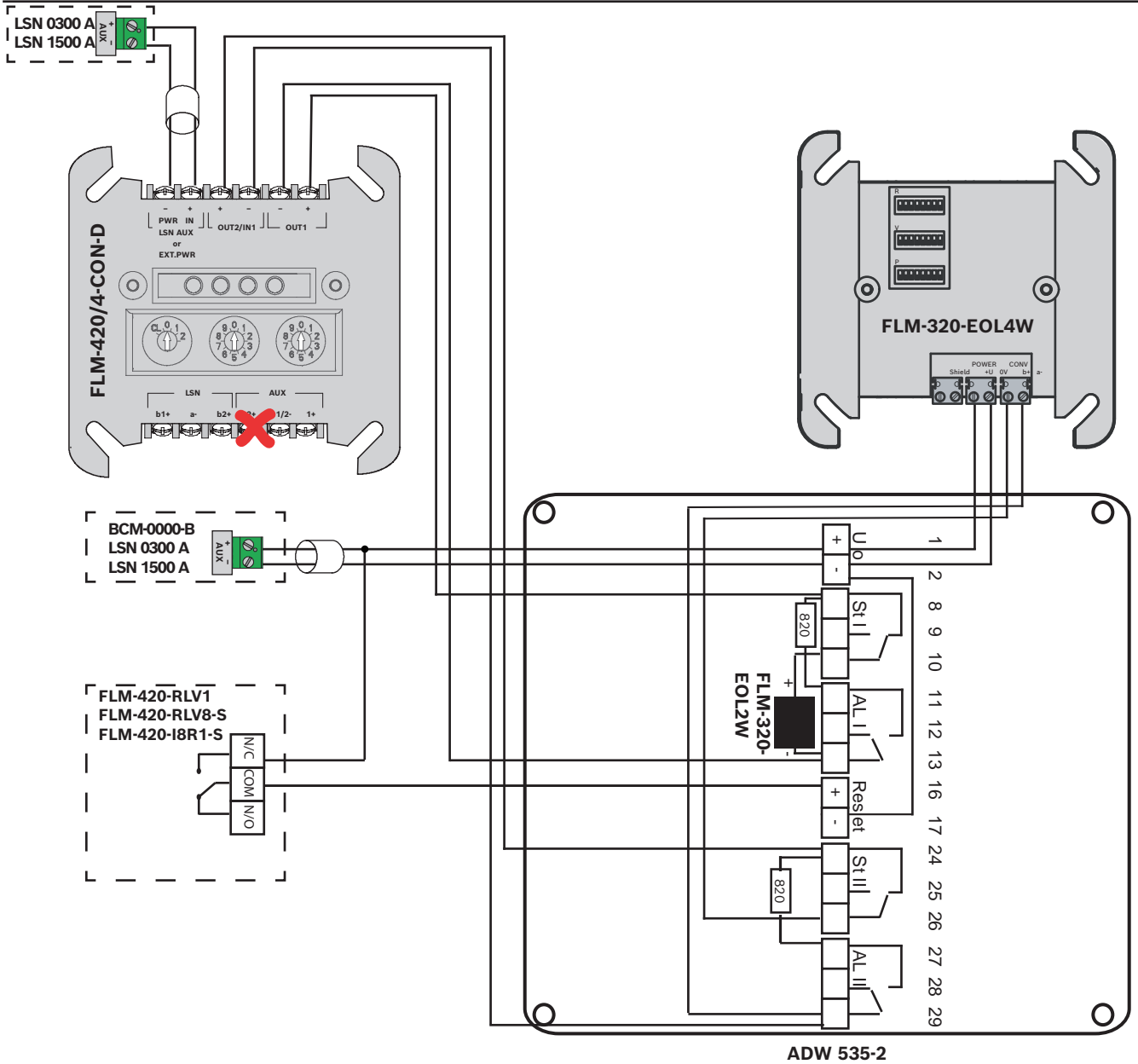
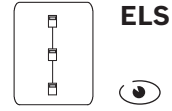

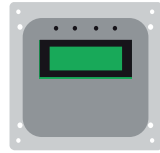

ALARMLINE II



ELS

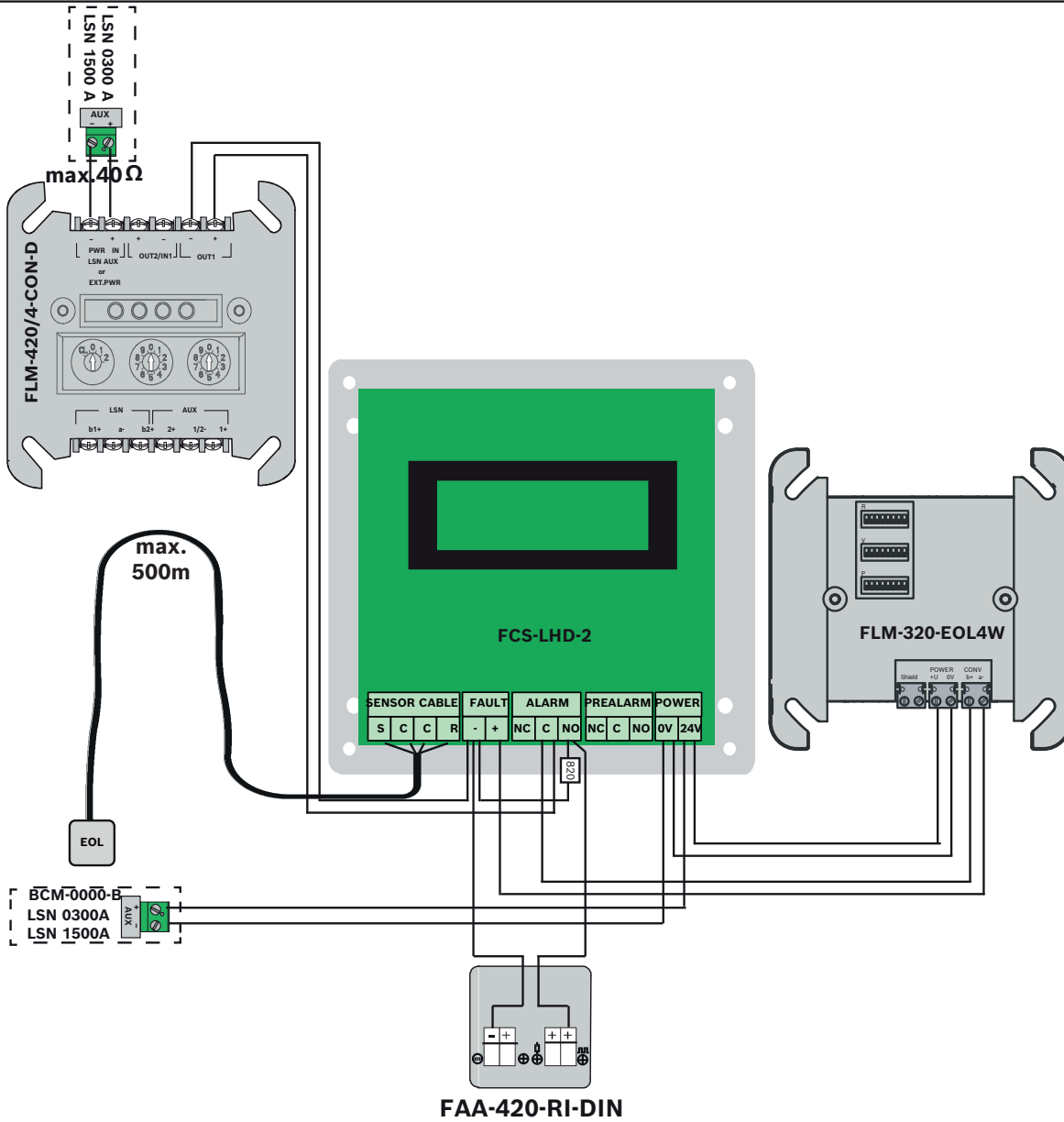





thefirebeam nano  
thefirebeam standard  
thefirebeam foveo

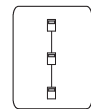

ELS

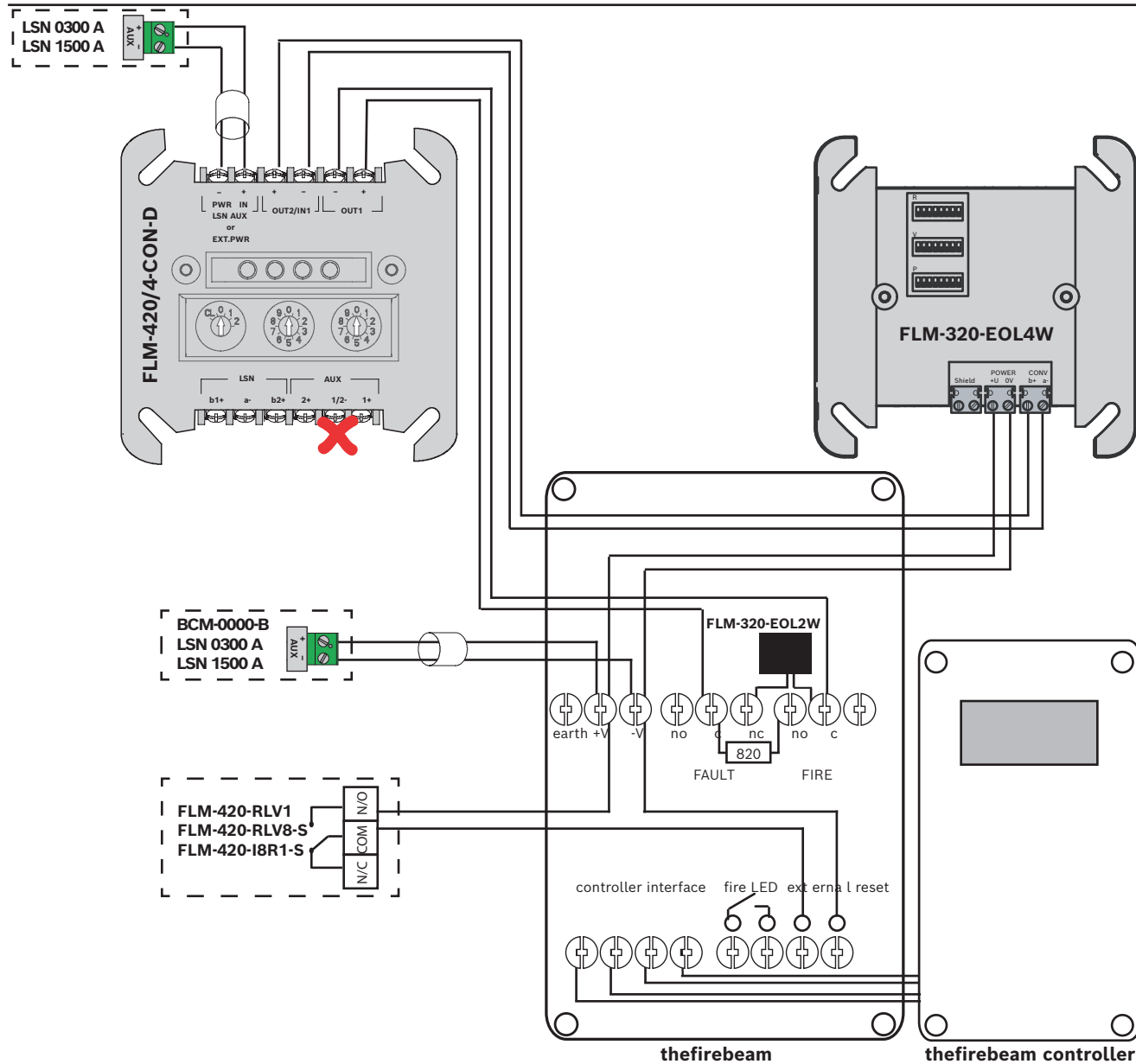

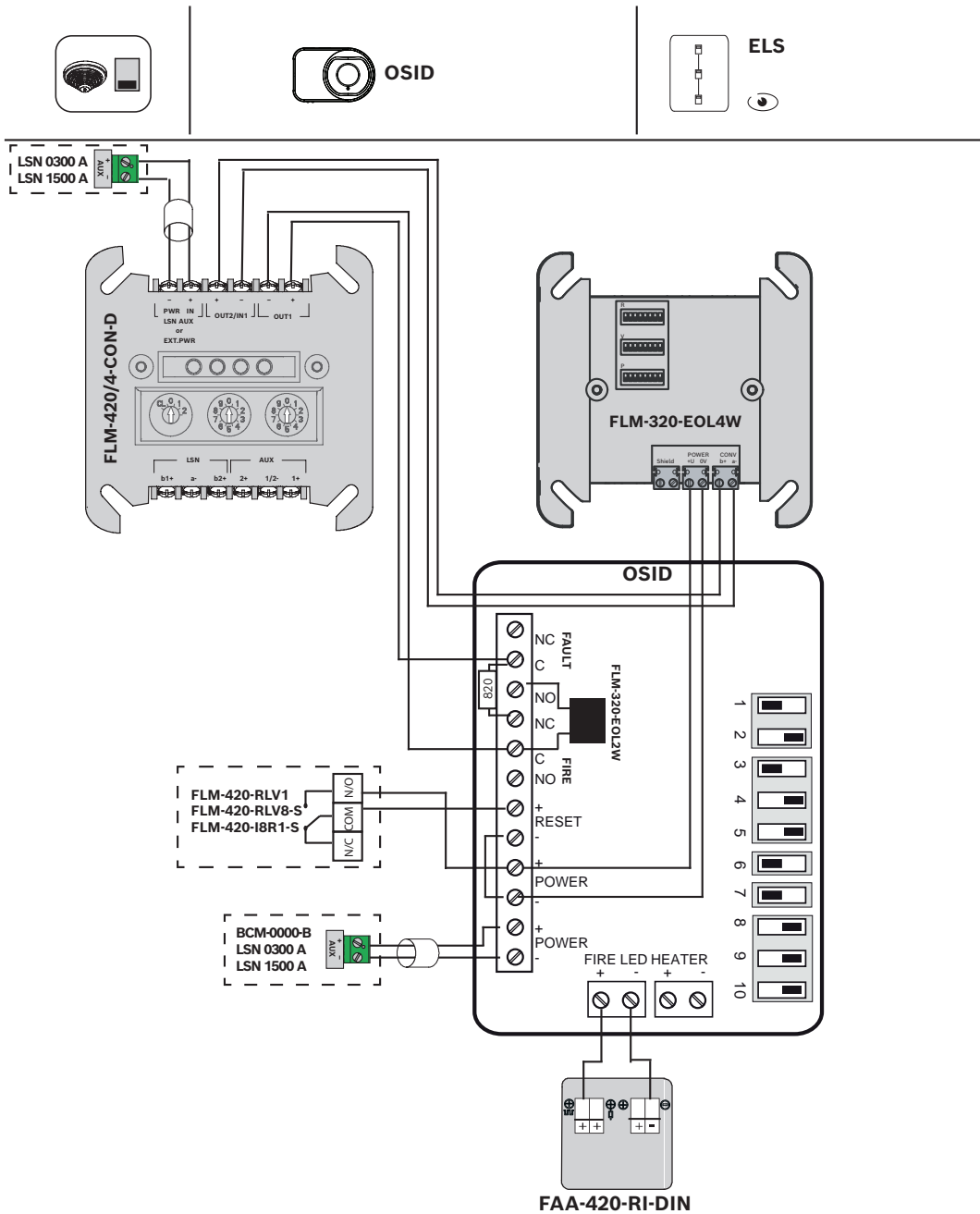

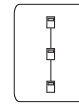

ELS

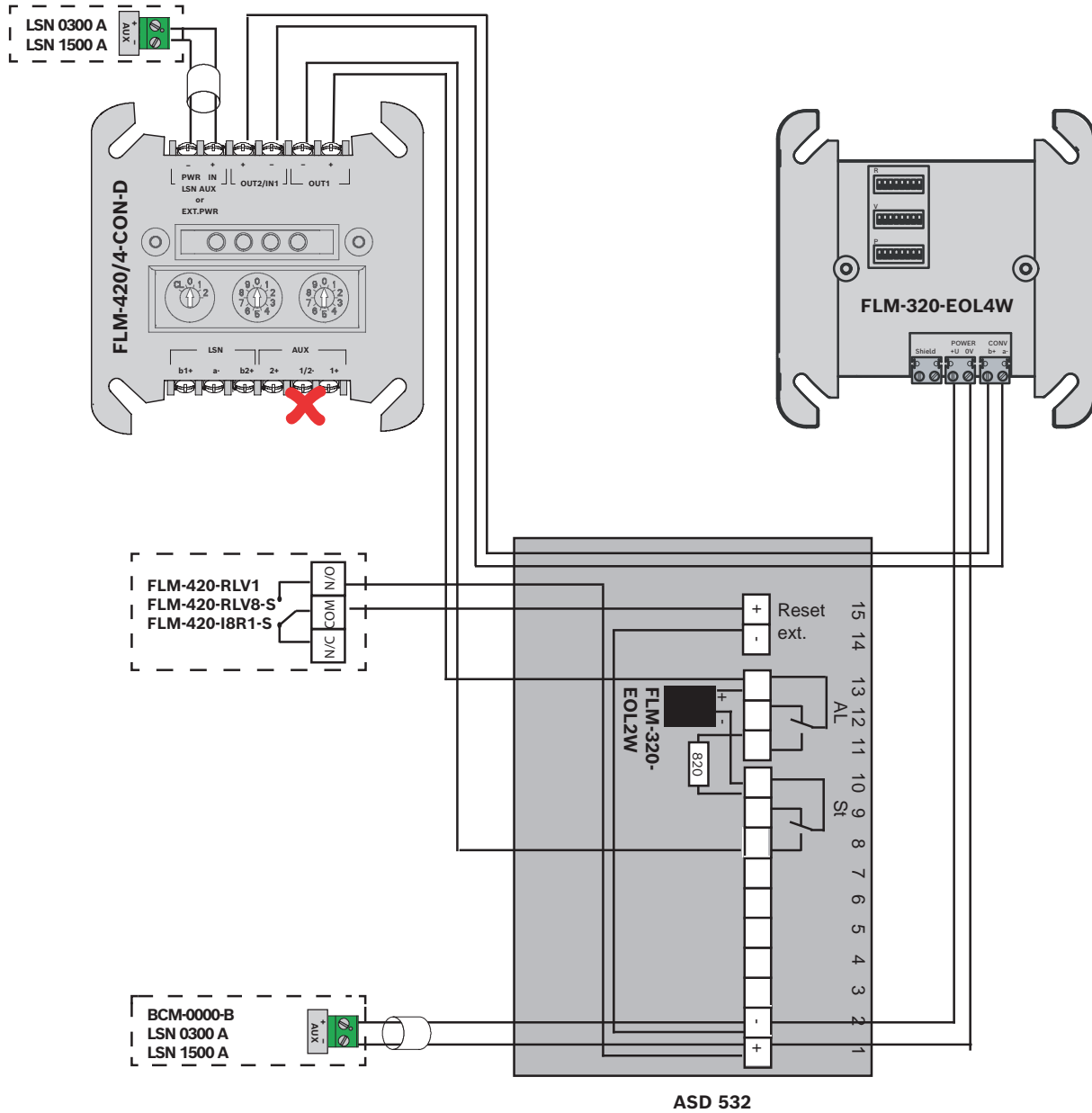

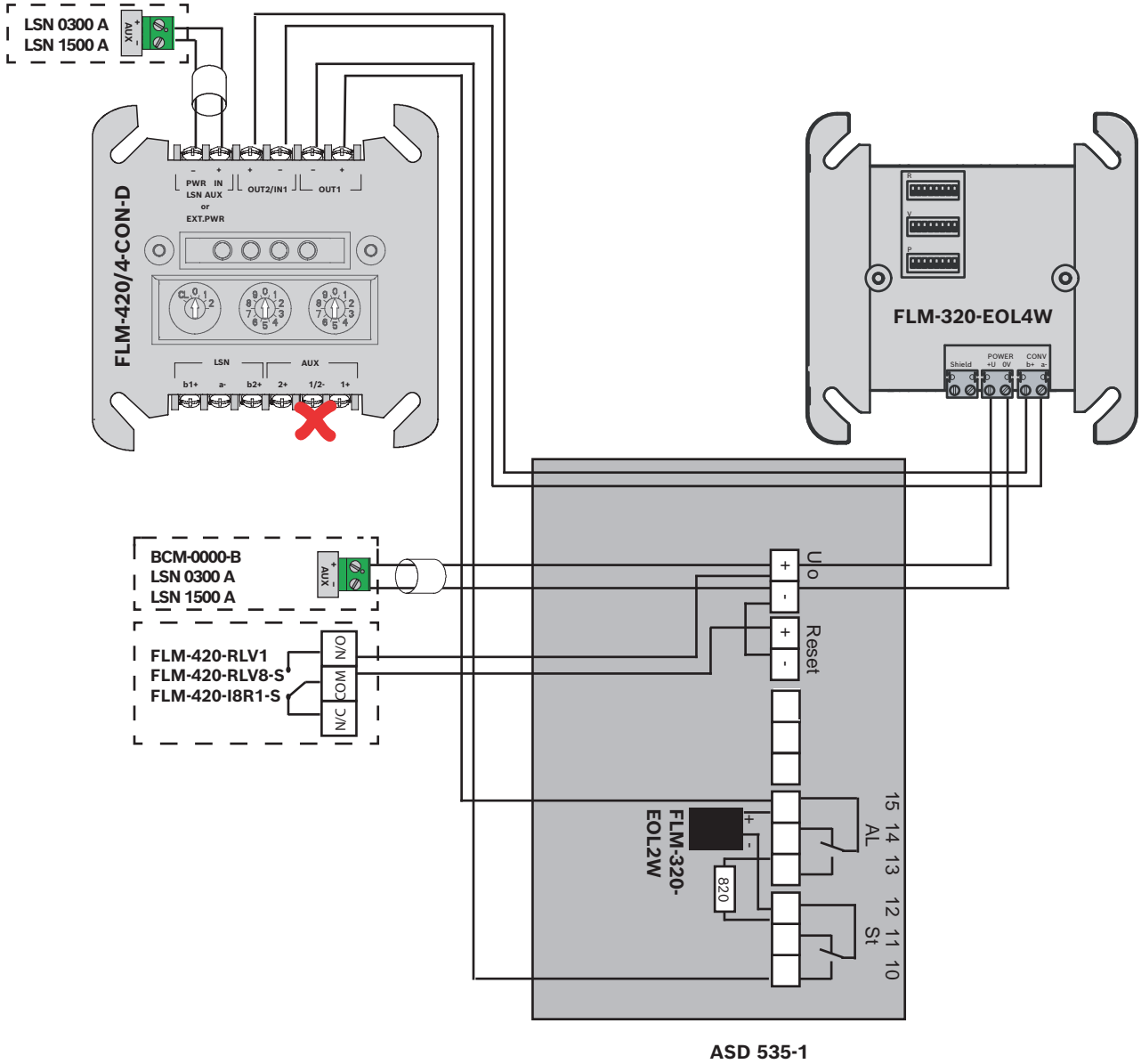
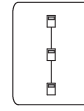

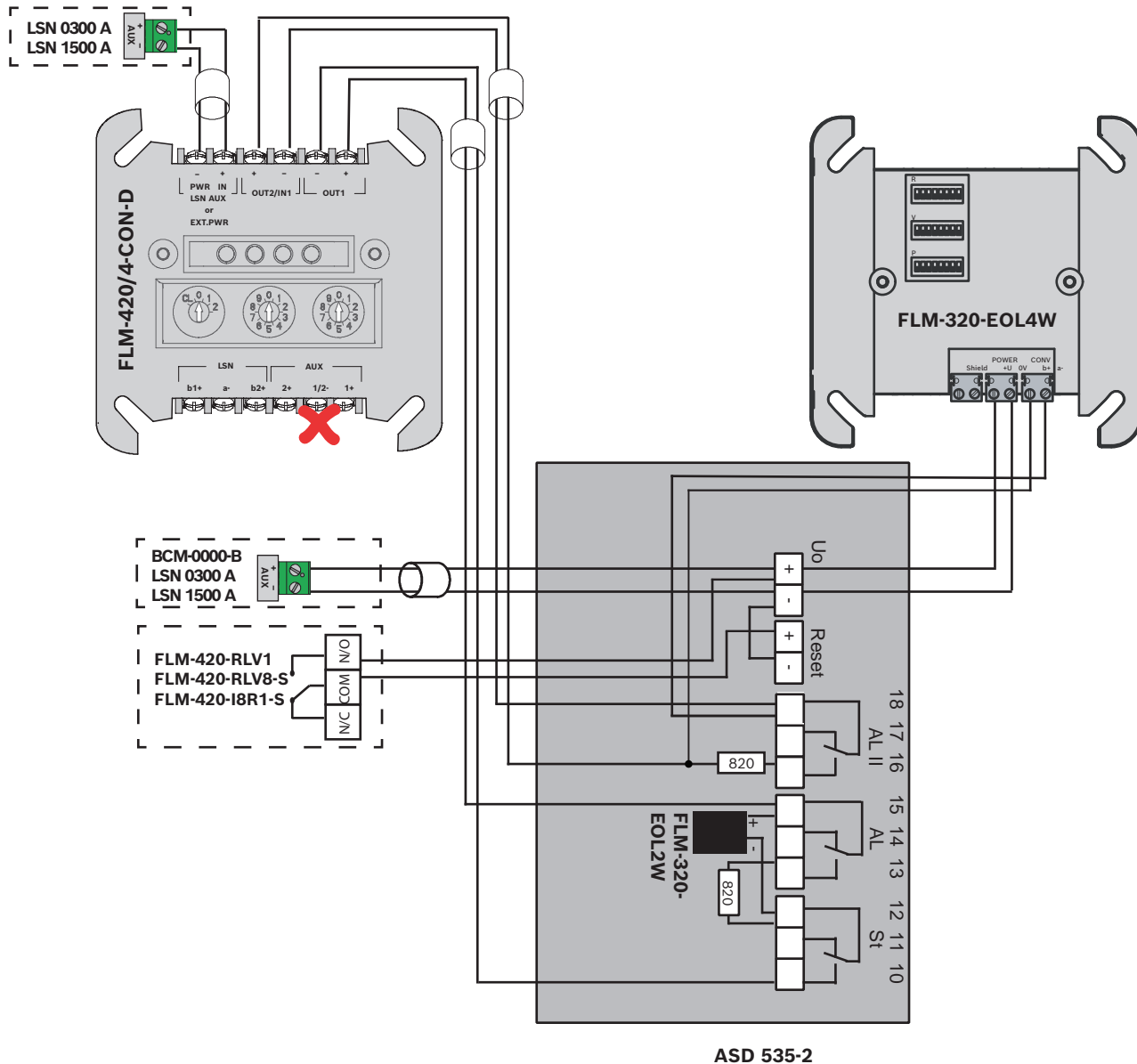
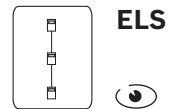



FCS-LWM-1

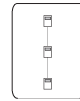

ELS

BCM-0000-B  
LSN 0300 A  
LSN 1500 A

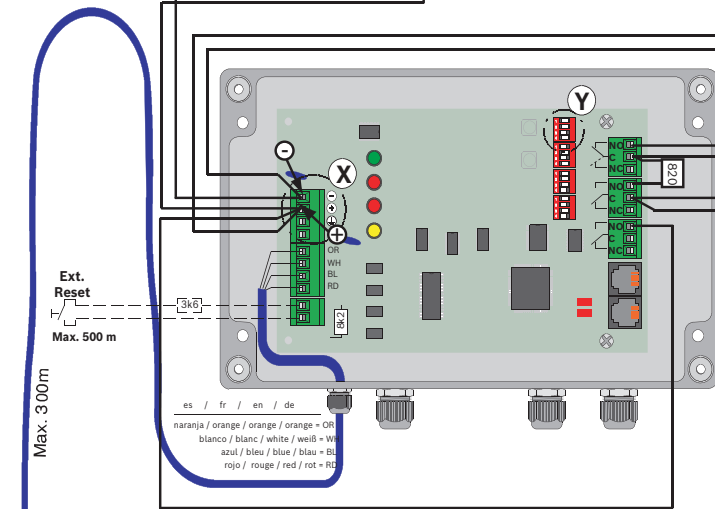
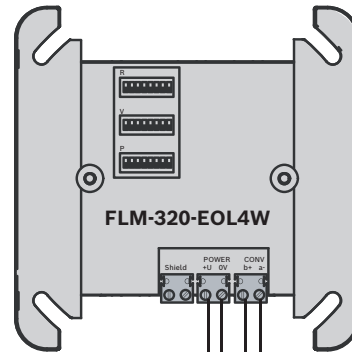
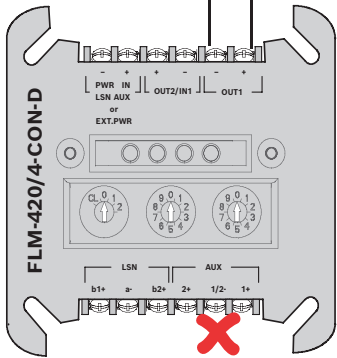

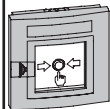
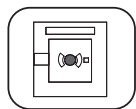

FMC-120-DKM-G-R FMC-120-DKM-G-Y  
 FMC-120-DKM-H-R FMC-120-EST-G-B  
 FMC-120-DKM-G-B  
 FMC-120-DKM-H-B

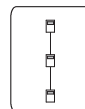

ELS

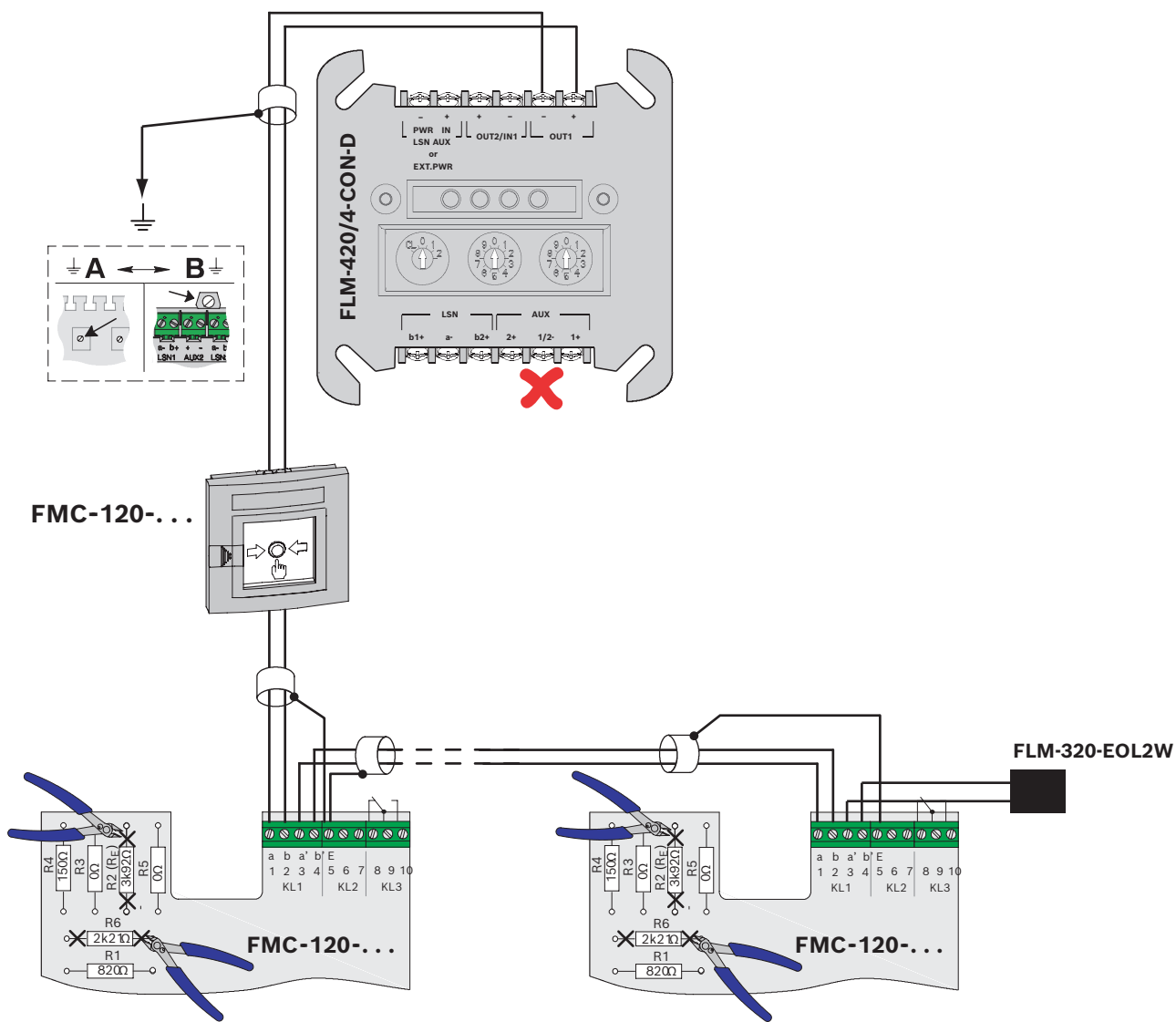

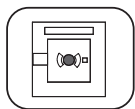

FMC-300

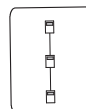

ELS

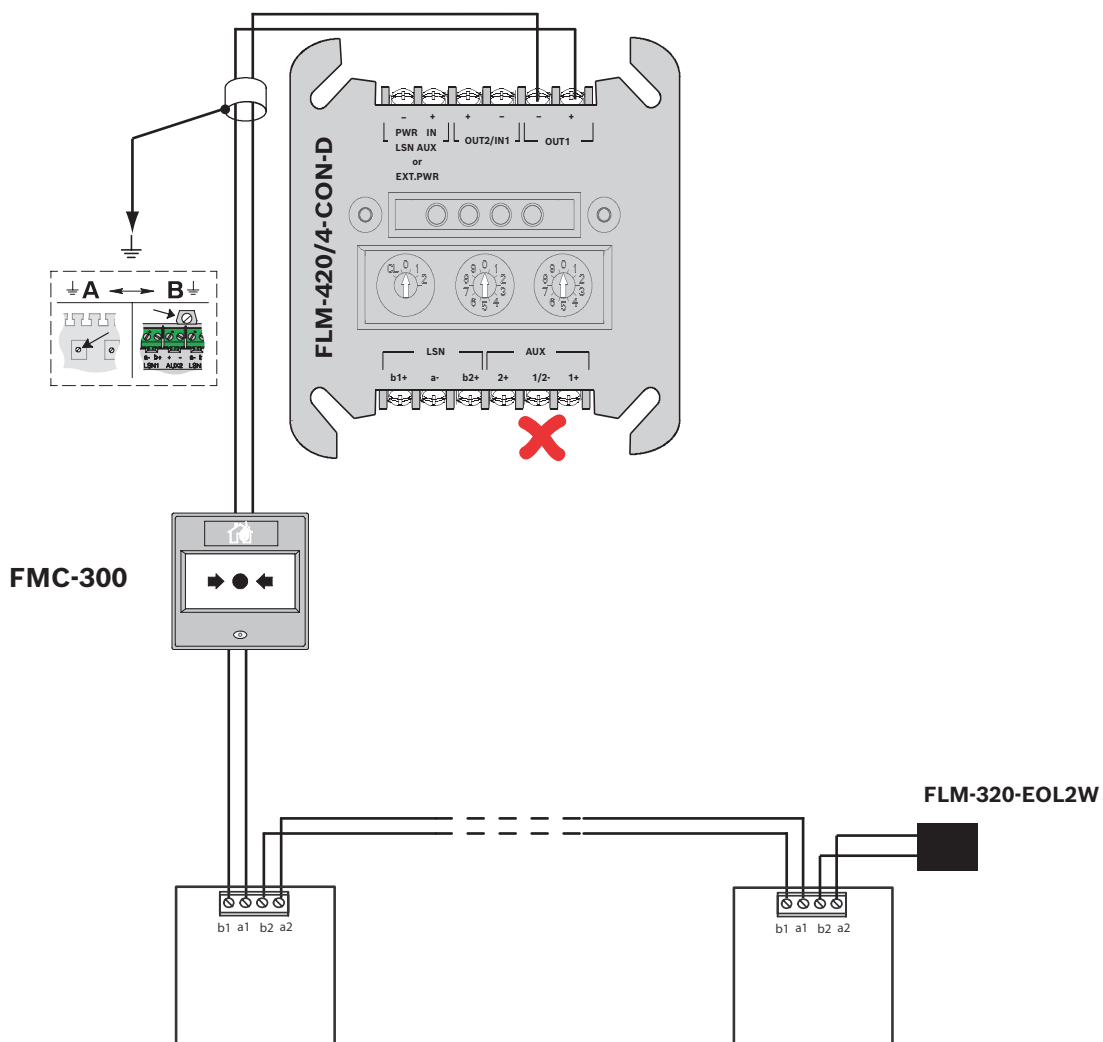







FCP-500



ELS

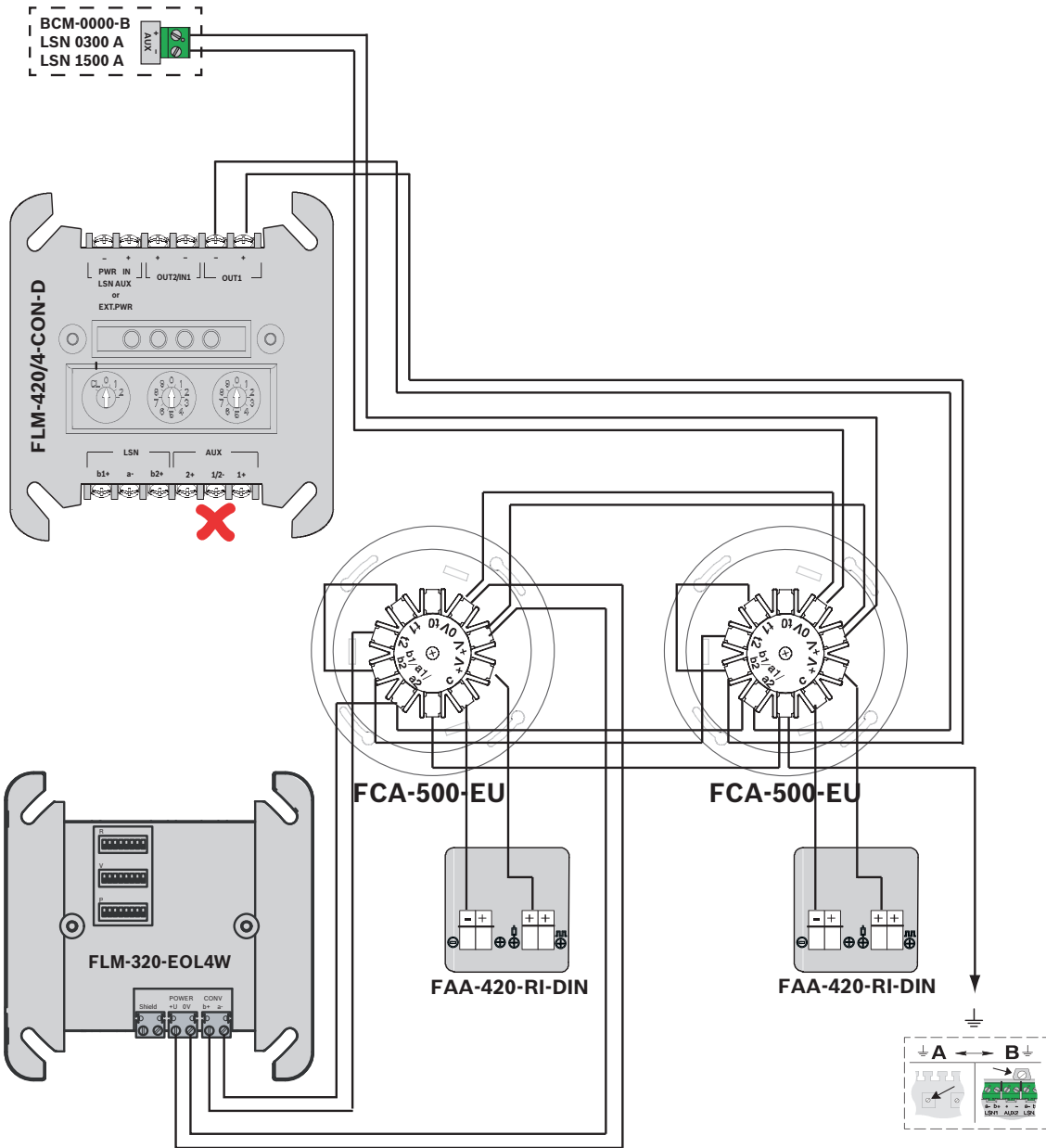

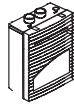

FCS-320-TM Series

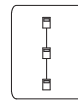

ELS

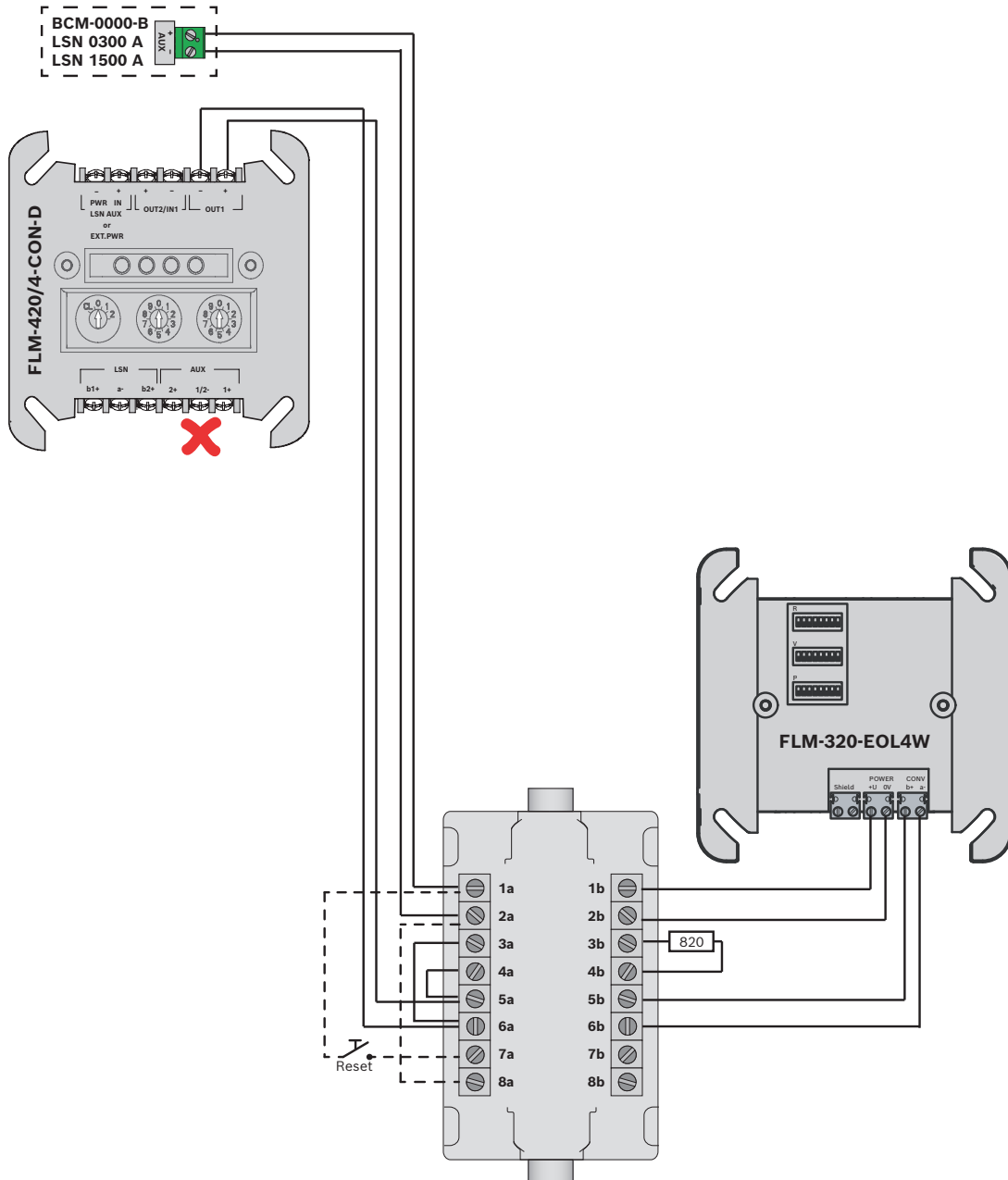

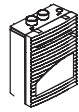

FCS-320-TP Series

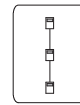

ELS

BCM-0000-B  
LSN 0300 A  
LSN 1500 A

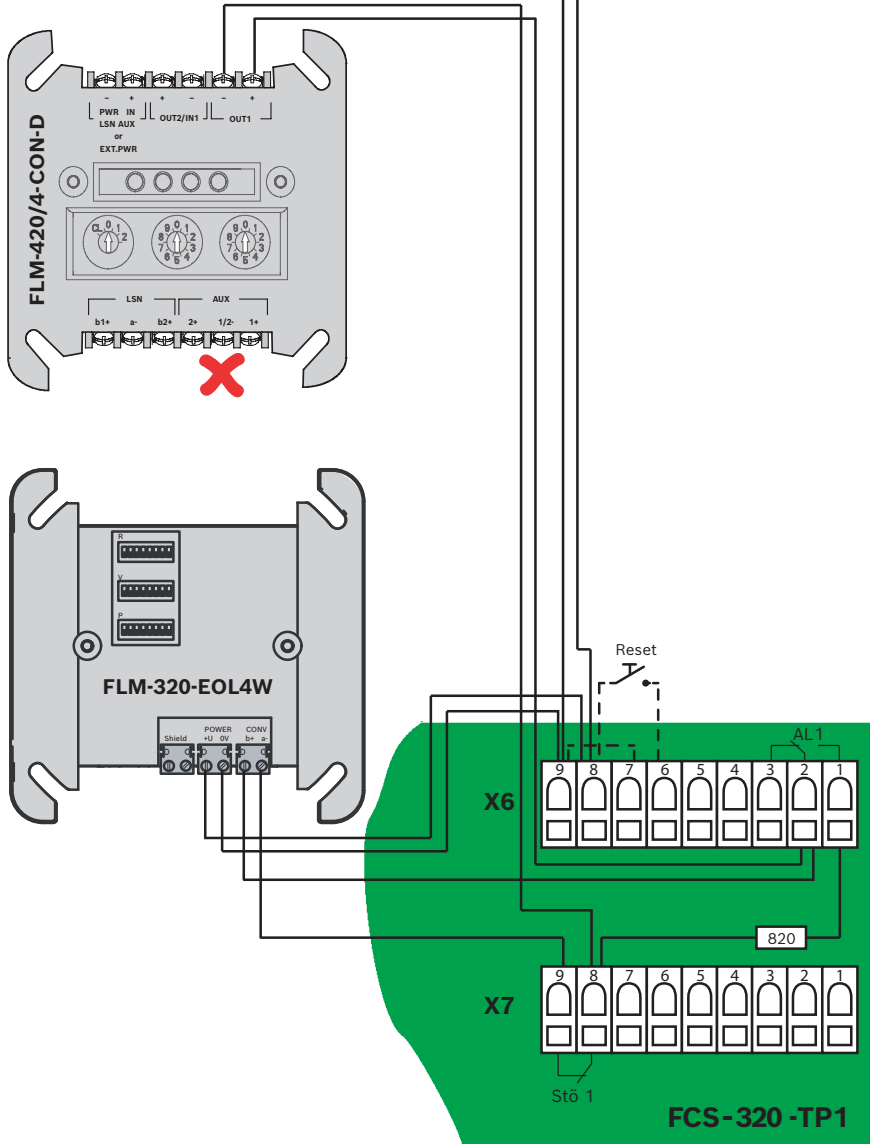

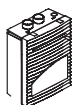

FCS-320-TP Series



ELS

BCM-0000-B  
LSN 0300 A  
LSN 1500 A

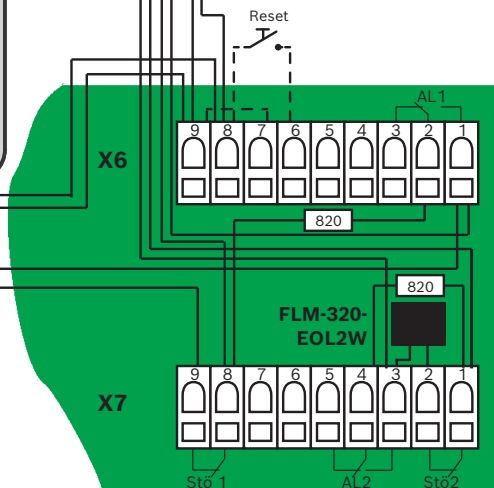
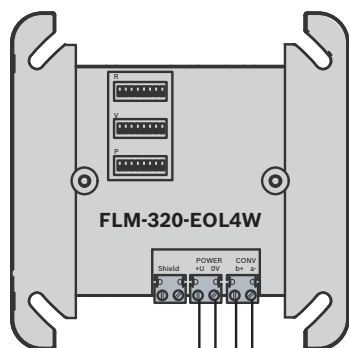
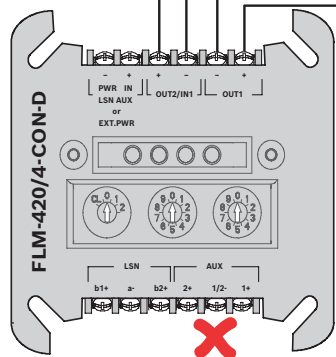

FCS-320-TP2

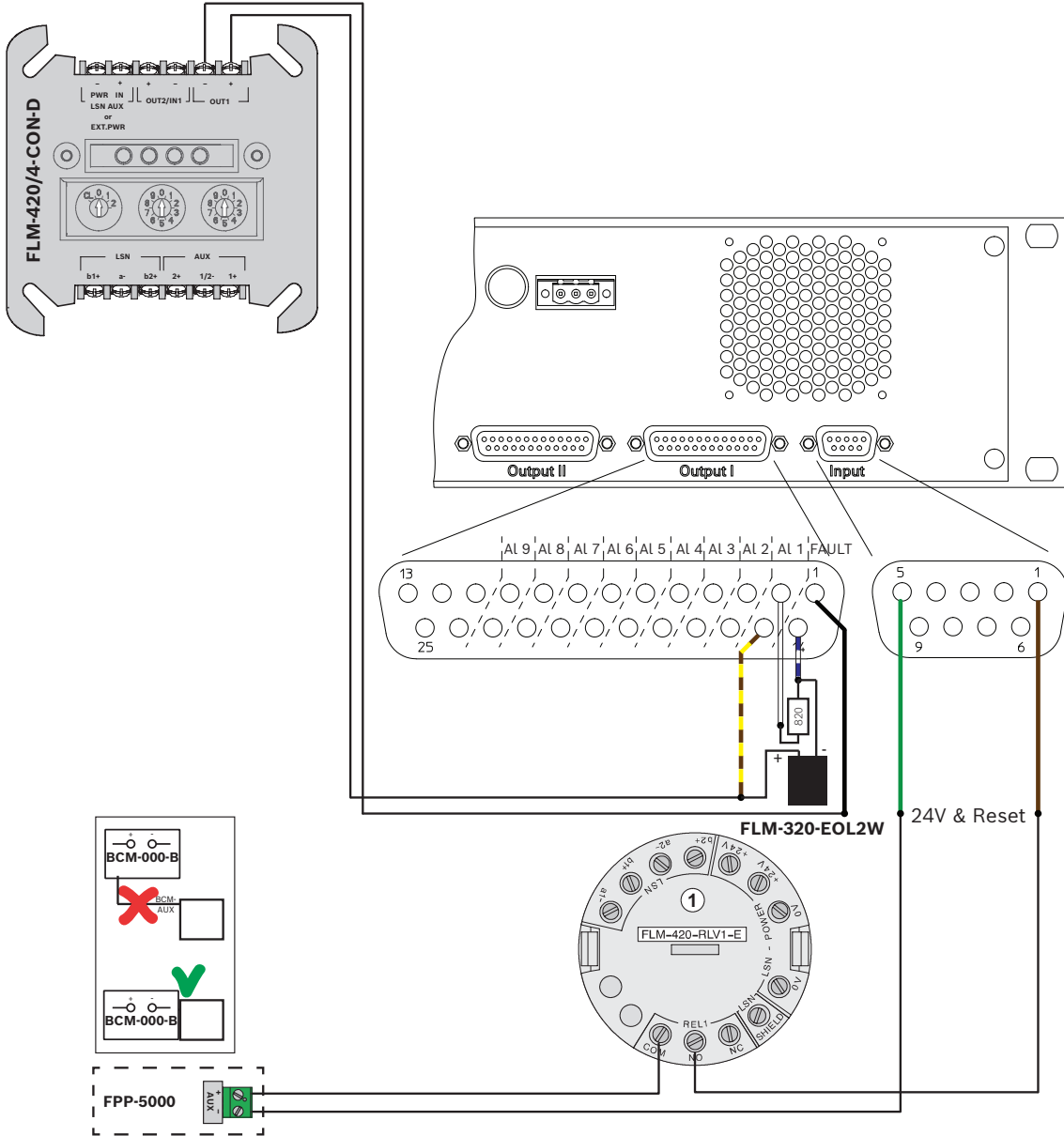
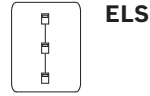

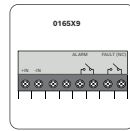

**016519, 016589**  
**IR3 Flame Detector**

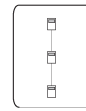

**ELS**

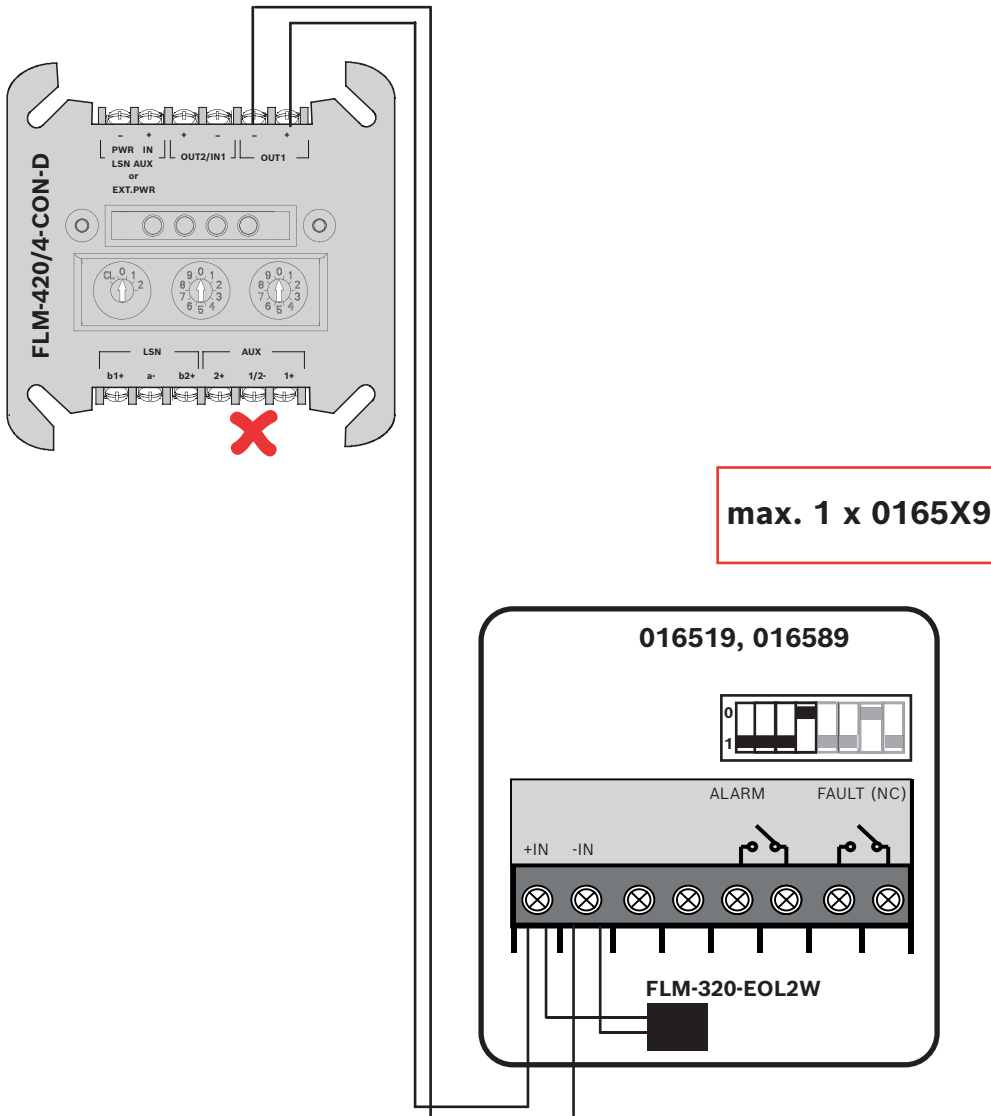

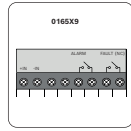

**016519, 016589**  
**IR3 Flame Detector**

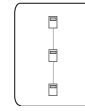

**ELS**

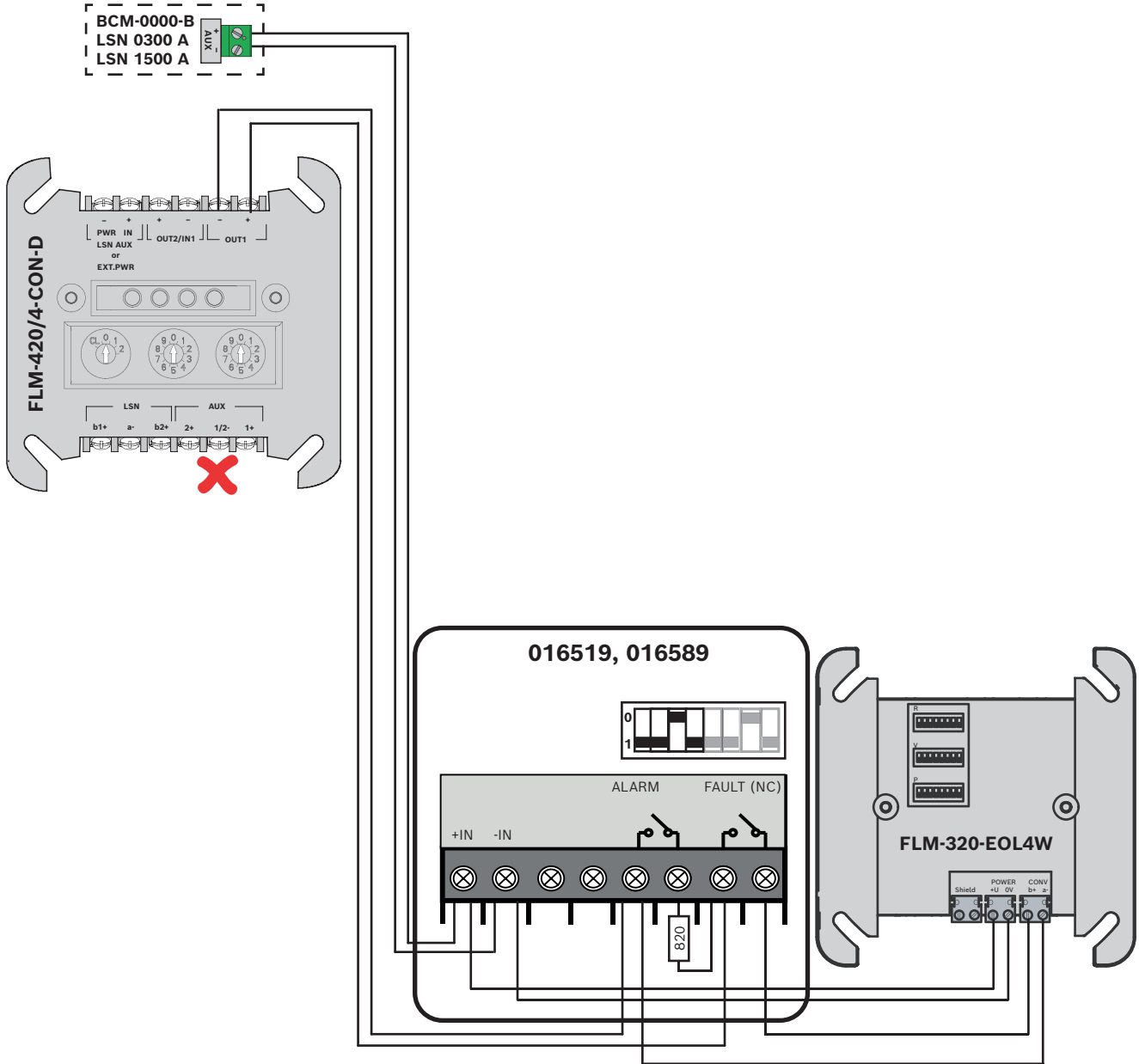





**Fireray 50RV  
Fireray 100RV**

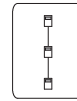

**ELS**

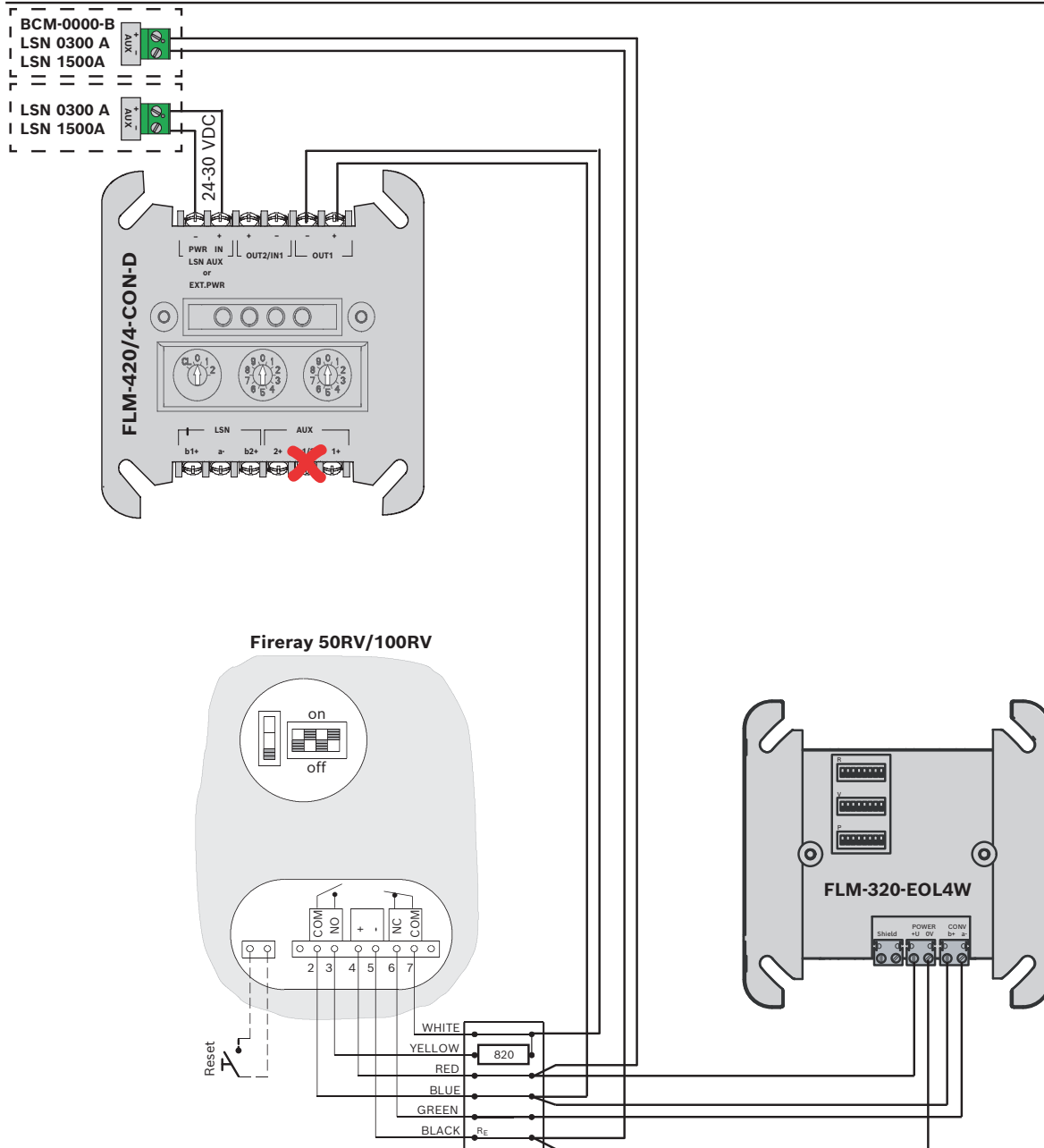

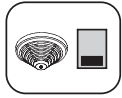

**FIRERAY3000**

1 x

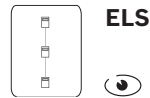

**ELS**

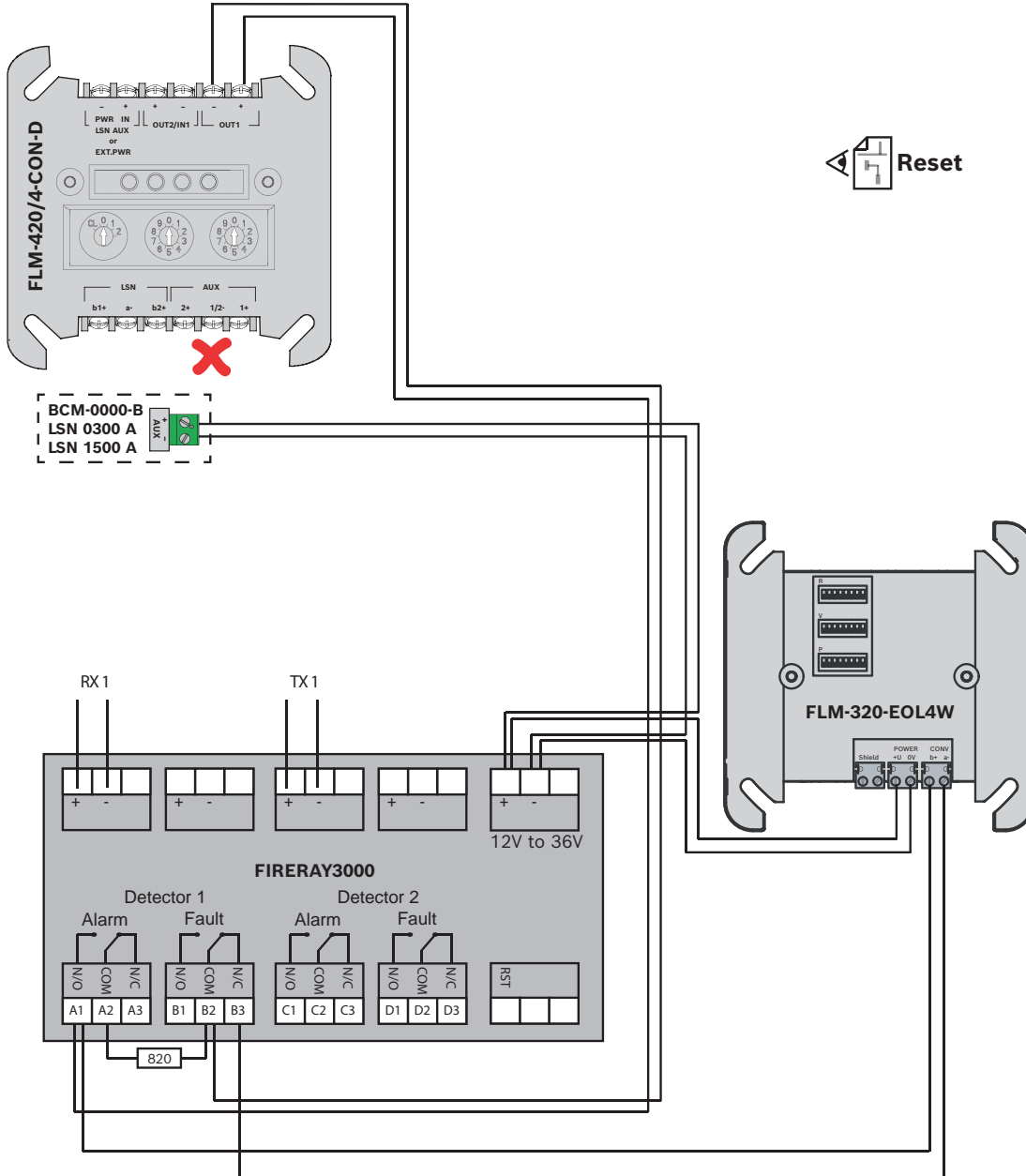



**FIRERAY3000**  
2 x **OUT1**

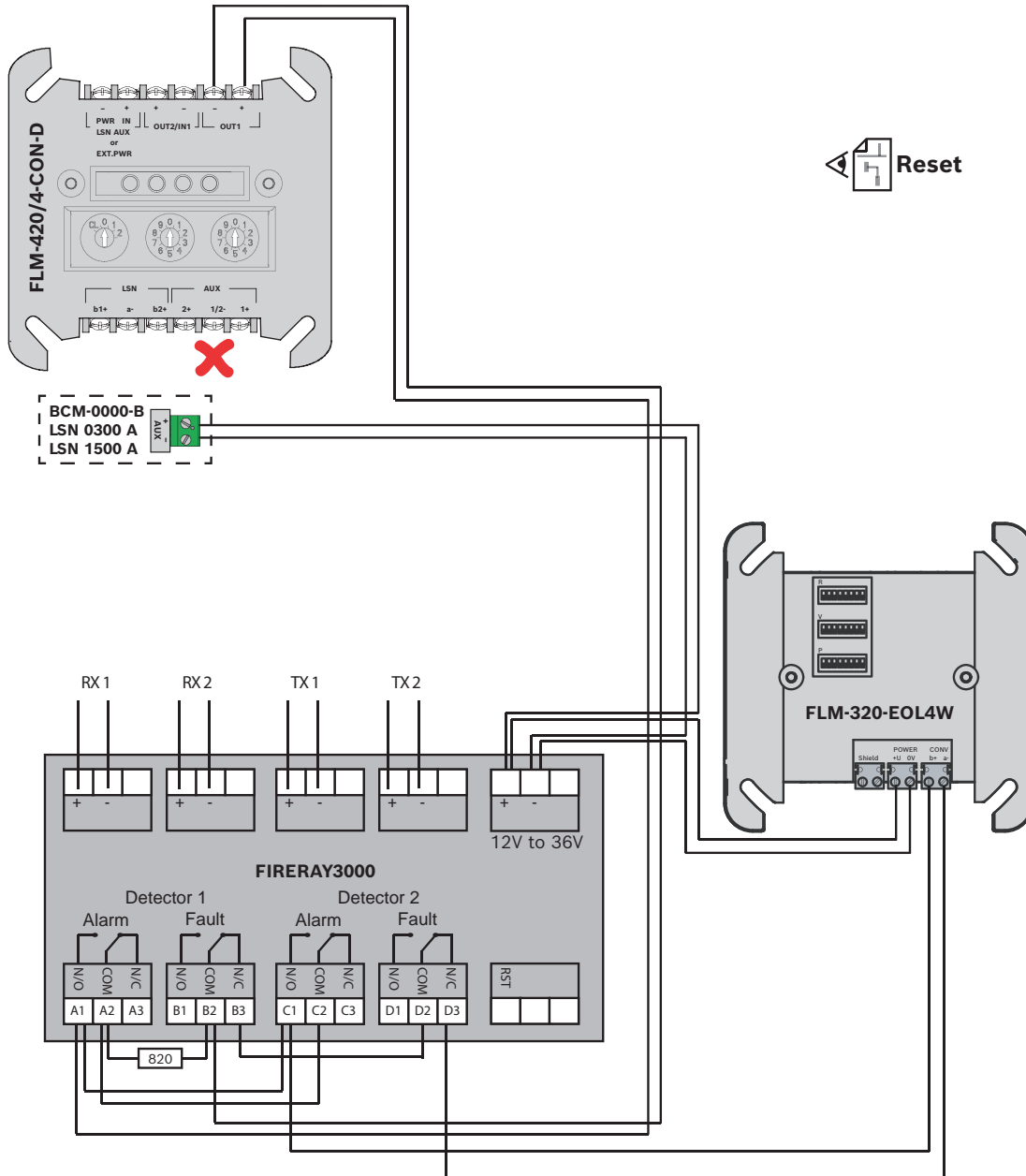
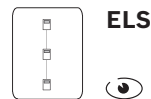



**FIRERAY3000**  
2 x **OUT1+2**



**ELS**

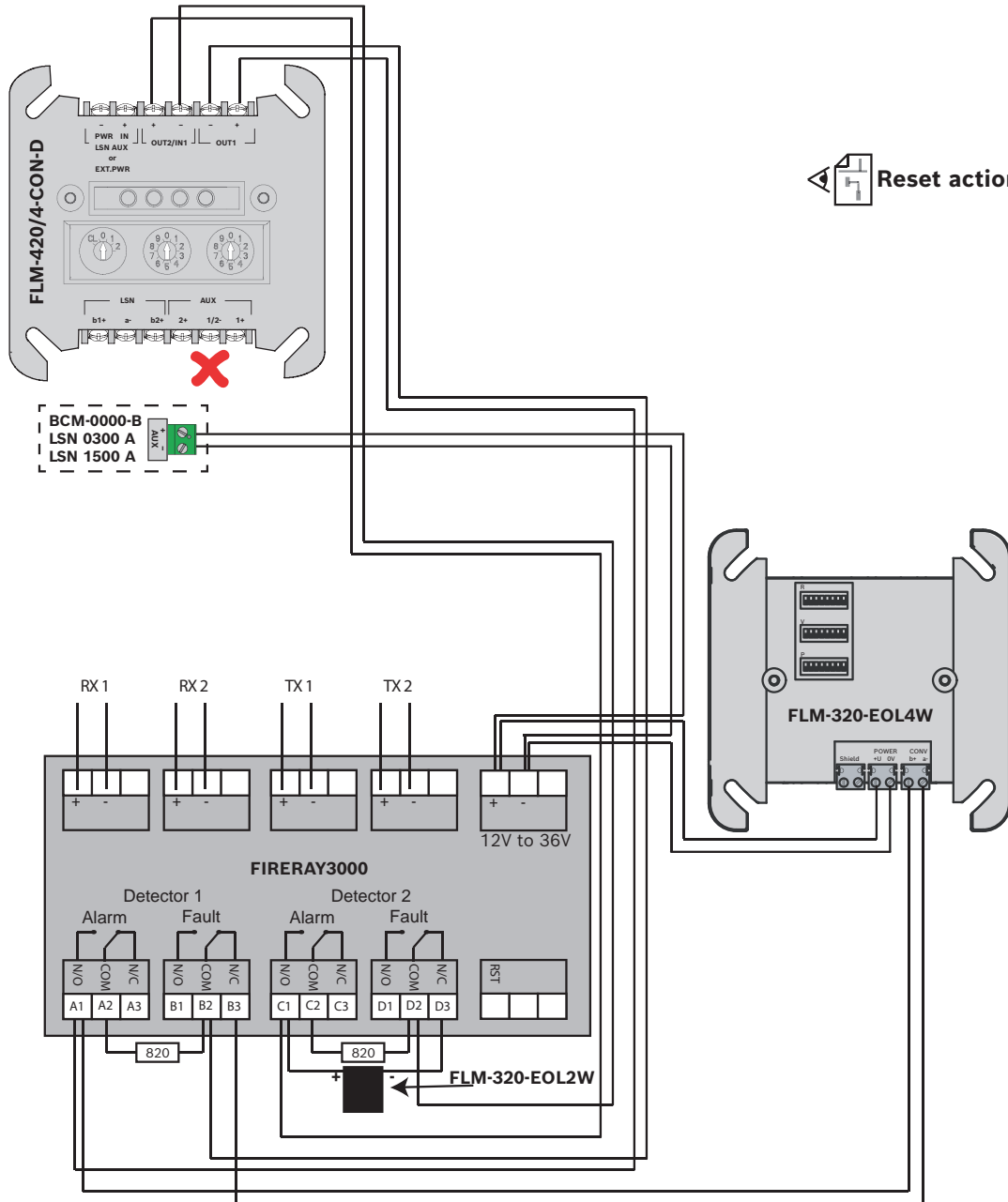



**FIRERAY5000**

1 x



**ELS**

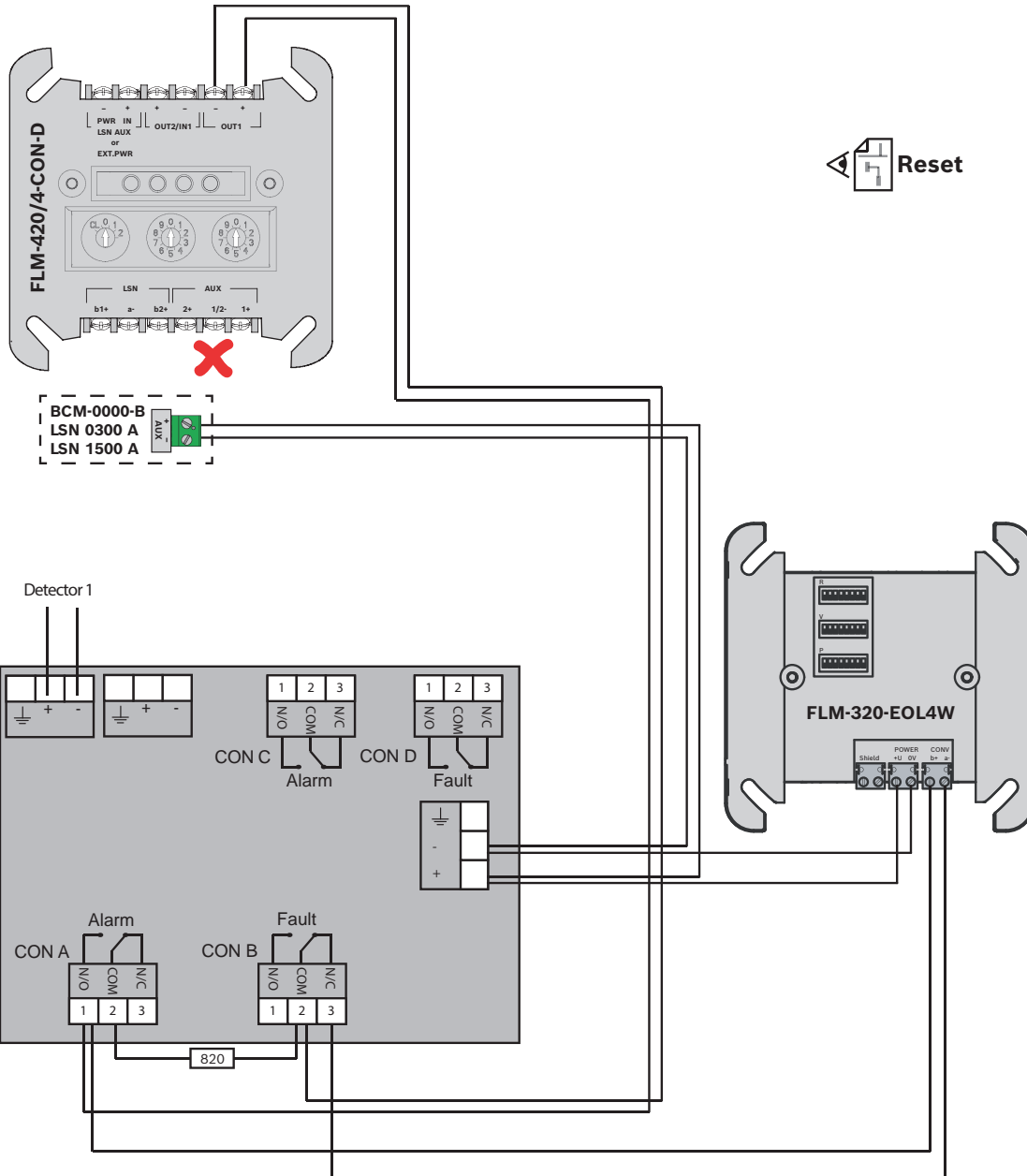



**FIRERAY5000**

**2 x OUT1**



**ELS**

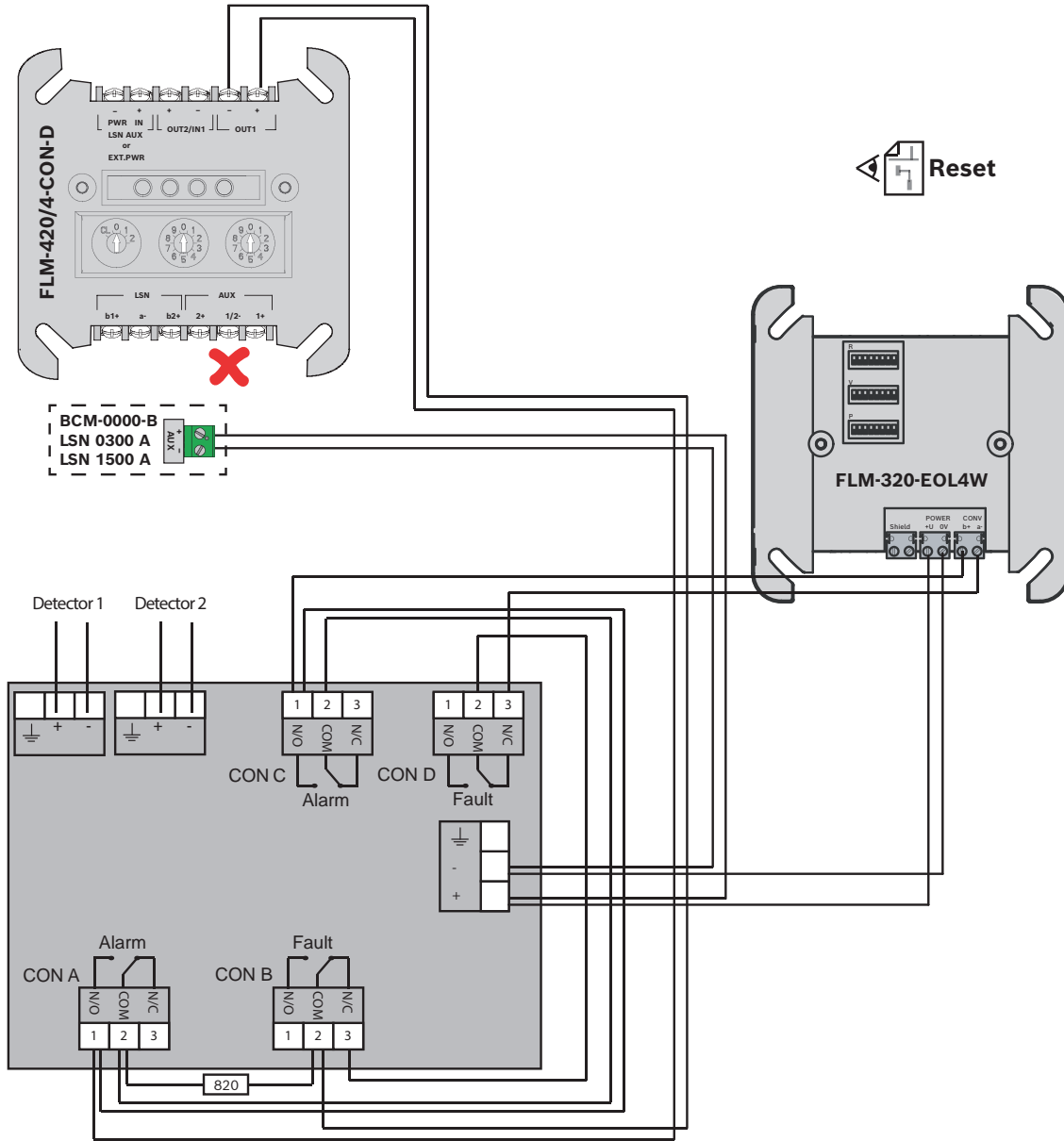



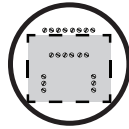

UniVario WMX5000  
 UniVario FMX5000  
 UniVario KMX5000



ELS

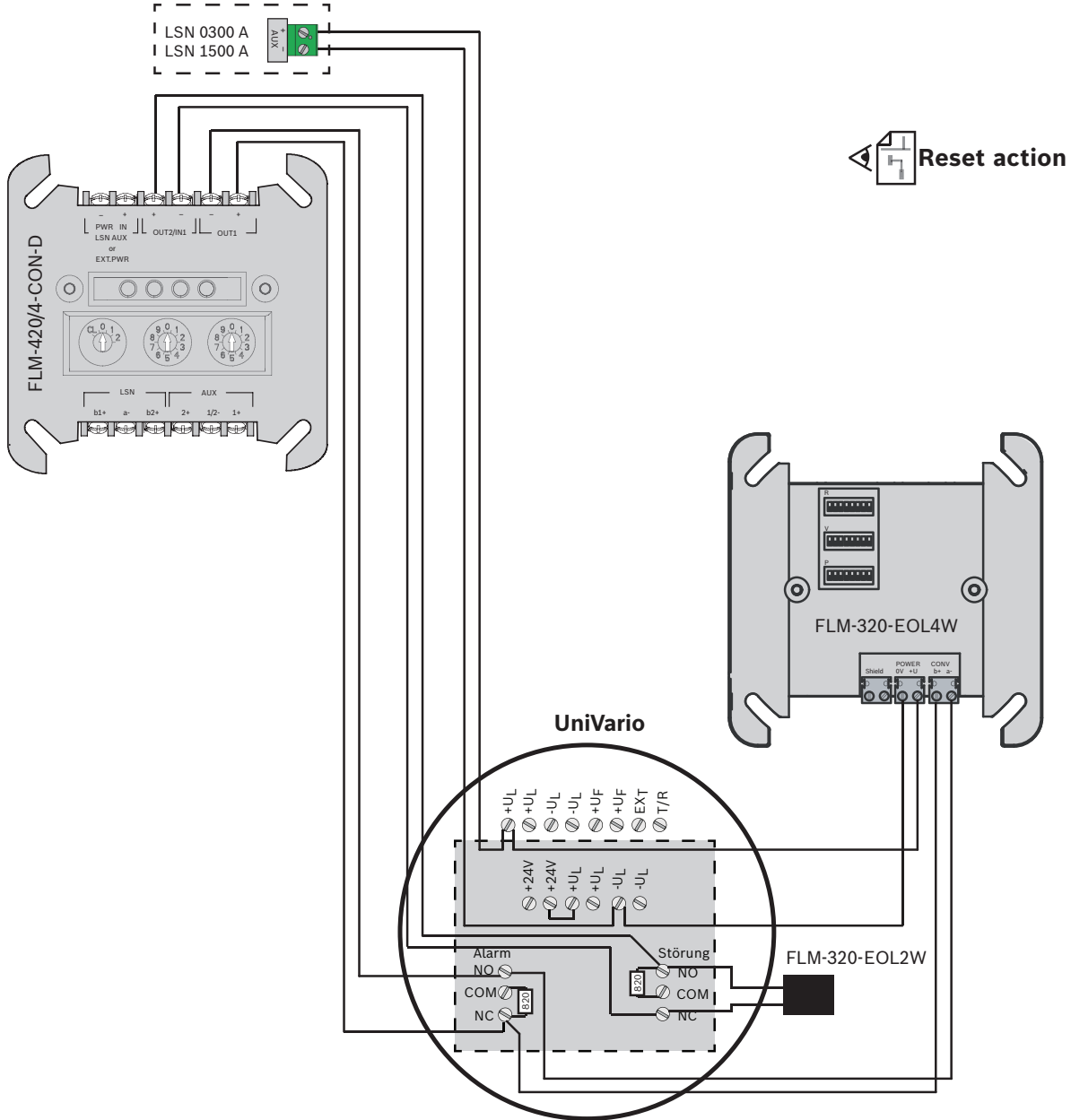



# Index

## Ziffern

016519 ->	
CZM 0004 A	52, 53
FLM-420/4-CON-D	134, 135, 136, 137
FLM-420/4-CON-D (EOL)	263, 264
016589 ->	
CZM 0004 A	53
FCS-LWM-1	52
FLM-420/4-CON-D	134, 135, 136, 137
FLM-420/4-CON-D (EOL)	263, 264
2014/2 Ex ->	
FLM-420/4-CON-D	155
2014/2 GLU-Ex ->	
FLM-420/4-CON-D	155
837 ->	
FAA-MSR 420	17, 18
FLM-420-RHV	27, 28
838 ->	
FAA-MSR 420	17, 18
FLM-420-RHV	27, 28
858 ->	
FAA-MSR 420	17, 18
FLM-420-RHV	27, 28

## A

ADW 535-1 ->	
FLM-420/4-CON-D (EOL)	246
FLM-420-RHV	178, 179
ADW 535-2 ->	
FLM-420/4-CON-D (EOL)	247
FLM-420-RHV	180, 181
ALARMLINE II ->	
FLM-420/4-CON-D	125
FLM-420/4-CON-D (EOL)	248
ASD 532 ->	
FLM-420/4-CON-D (EOL)	251
FLM-420-RHV	176, 177
ASD 535-1 ->	
FLM-420/4-CON-D (EOL)	252
FLM-420-RHV	172, 173
ASD 535-2 ->	
FLM-420/4-CON-D (EOL)	253
FLM-420-RHV	174, 175
ASD 535-3 ->	
FLM-420-RHV	172, 173
ASD 535-4 ->	
FLM-420-RHV	174, 175
AT5000 IP/GPRS ->	
ENO 0000 A/B	61
ATB 420 LSNi ->	
LSN 0300 A	93
LSN 0300 A (EOL)	233, 234, 235, 236
ATG 420 LSNi ->	
LSN 0300 A	94
LSN 0300 A (EOL)	237, 238, 239, 240

## B

BCM-0000-B ->	
FPP-5000-TI	11
FPP-5000-TI13	12
BTS 80 ->	
FAA-MSR 420	19, 20
BTS 80 EMB ->	
FLM-420-RHV	29, 30
BTS 80 FLB ->	
FAA-MSR 420	19, 20
FLM-420-RHV	29, 30

<b>C</b>		<b>D</b>	
C31B ->		DC1192, SB3 ->	
LSN 0300 A	103, 104	FLM-420/4-CON-D	149, 150
CZM 0004 A		FLM-420/4-CON-D (EOL)	271
016519	52, 53	DF 1192	
016589	52, 53	FAA-420-RI-DIN	151
FCA-500	58	DF 1192 ->	
FCS-320-TM	54	FLM-420/4-CON-D	151
FCS-320-TP1	55	DF1101-A-EX ->	
FCS-320-TP2	56	FLM-420/4-CON-D	149, 150
FCS-LWM-1	57	FLM-420/4-CON-D (EOL)	271
Fireray 100RV	45	DIBT	
Fireray 50RV	45	837 -> FAA-MSR 420	17, 18
FIRERAY3000	46, 47, 48	837 -> FLM-420-RHV	27, 28
FIRERAY5000	49, 50, 51	838 -> FAA-MSR 420	17, 18
FMC-120	59	838 -> FLM-420-RHV	27, 28
FMC-300	60	858 -> FAA-MSR 420	17, 18
		858 -> FLM-420-RHV	27, 28
		BTS 80 EMB -> FAA-MSR 420	19, 20
		BTS 80 EMB -> FLM-420-RHV	29, 30
		BTS 80 FLB -> FAA-MSR 420	19, 20
		BTS 80 FLB -> FLM-420-RHV	29, 30
		ED 100 -> FAA-MSR-420	15, 16
		ED 100 -> FLM-420-RHV	25, 26
		ED 250 -> FAA-MSR-420	15, 16
		ED 250 -> FLM-420-RHV	25, 26
		GT 40 R -> FAA-MSR 420	17, 18
		GT 40 R -> FLM-420-RHV	27, 28
		GT 42 R -> FAA-MSR 420	17, 18
		GT 42 R -> FLM-420-RHV	27, 28
		GT 50 R -> FAA-MSR 420	17, 18
		GT 50 R -> FLM-420-RHV	27, 28
		GT 60 R -> FAA-MSR 420	17, 18
		GT 60 R -> FLM-420-RHV	27, 28
		GT 63 R -> FAA-MSR 420	17, 18
		GT 63 R -> FLM-420-RHV	27, 28
		GT 70 R -> FAA-MSR 420	17, 18
		GT 70 R -> FLM-420-RHV	27, 28
		GT 70 R 050.01 Ex -> FAA-MSR 420	17, 18
		GT 70 R 050.01 Ex -> FLM-420-RHV	27, 28
		Slimdrive EMD-F -> FAA-MSR-420	21, 22
		Slimdrive EMD-F -> FLM-420-RHV	31, 32
		Slimdrive EMD-F-IS -> FAA-MSR-420	21, 22
		Slimdrive EMD-F-IS -> FLM-420-RHV	31, 32
		TS 4000 E -> FAA-MSR-420	23, 24
		TS 4000 E -> FLM-420-RHV	33, 34
		TS 4000 EFS -> FAA-MSR-420	23, 24
		TS 4000 EFS -> FLM-420-RHV	33, 34
		TS 4000 E-IS -> FAA-MSR-420	23, 24

TS 4000 E-IS -> FLM-420-RHV	33, 34	EOL	201, 202, 203
TS 5000 E -> FAA-MSR-420	23, 24	016519 -> FLM-420/4-CON-D	263, 264
TS 5000 E -> FLM-420-RHV	33, 34	016519 ->:CZM 0004 A	189, 190
TS 5000 E-IS -> FAA-MSR-420	23, 24	016589 -> FLM-420/4-CON-D	263, 264
TS 5000 E-IS -> FLM-420-RHV	33, 34	016589 ->:CZM 0004 A	190
TS 5000 E-ISM -> FAA-MSR-420	23, 24	ADW 535-1 -> FLM-420/4-CON-D	246
TS 5000 E-ISM -> FLM-420-RHV	33, 34	ADW 535-2 -> FLM-420/4-CON-D	247
TS 550 E -> FAA-MSR-420	23, 24	ALARMLINE II -> FLM-420/4-CON-D	248
TS 550 E -> FLM-420-RHV	33, 34	ASD 532 -> FLM-420/4-CON-D	251
TS 73 EMF -> FAA-MSR 420	19, 20	ASD 535-1 -> FLM-420/4-CON-D	252
TS 73 EMF -> FLM-420-RHV	29, 30	ASD 535-2 -> FLM-420/4-CON-D	253
TS 93 EMF -> FAA-MSR 420	19, 20	ATB 420 LSNi -> LSN 0300 A	233, 234, 235, 236
TS 93 EMF -> FLM-420-RHV	29, 30	ATG 420 LSNi -> LSN 0300 A	237, 238, 239, 240
TS 93 GSR/EMF1 -> FAA-MSR 420	19, 20	CZM 0004 A: FCS-320-TM	192
TS 93 GSR/EMF1 -> FLM-420-RHV	29, 30	CZM 0004 A: FCS-320-TP1	193
TS 93 GSR/EMF2 -> FAA-MSR 420	19, 20	CZM 0004 A: FCS-320-TP2	194
TS 93 GSR/EMF2 -> FLM-420-RHV	29, 30	CZM 0004 A: FIRERAY3000	195, 196, 197
TSA 160 NT F -> FAA-MSR-420	23, 24	CZM 0004 A: FIRERAY5000	198
TSA 160 NT F -> FLM-420-RHV	33, 34	CZM 0004 A: FMC-120	199
TSA 160 NT F-IS -> FAA-MSR-420	23, 24	CZM 0004 A: FMC-300	200
TSA 160 NT F-IS -> FLM-420-RHV	33, 34	CZM 0004 A:016519	190
TSA 160 NT F-IS/TS -> FAA-MSR-420	23, 24	CZM 0004 A:016589	189, 190
TSA 160 NT F-IS/TS -> FLM-420-RHV	33, 34	CZM 0004 A:FCA-500-EU	191
TSZ 0400 -> FLM-420/4-CON-D	36	CZM 0004A:016519	189
TSZ 0400 -> FLM-420-I2-E/-W	37	CZM 0004A:016589	189
TSZ 0400 -> FLM-420-O111-E	38	DC1192, SB3 -> FLM-420/4-CON-D	271
DM 1103B-X ->		DF1101-A-EX -> FLM-420/4-CON-D	271
FLM-420/4-CON-D	149, 150	DM 1103B-X -> FLM-420/4-CON-D	271
FLM-420/4-CON-D (EOL)	271	DO1101-A-EX -> FLM-420/4-CON-D	271
DO1101-A-EX ->		FAA-500 -> LSN 0300 A	220
FLM-420/4-CON-D	149, 150	FAA-500-R -> LSN 0300 A	220
FLM-420/4-CON-D (EOL)	271	FAA-MSR 420 -> LSN 0300 A	221
<b>E</b>		FAP-425	257
ED 100 ->		FAP-425 -> LSN 0300 A	221, 222
FAA-MSR-420	15, 16	FAP-520 -> LSN 0300 A	220
FLM-420-RHV	25, 26	FAS-420 -> LSN 0300 A	223, 224
ED 250 ->		FAS-420-TM -> LSN 0300 A	225, 226, 227, 228
FAA-MSR-420	15, 16	FBF 100 LSN -> LSN 0300 A	229, 230, 231, 232
FLM-420-RHV	25, 26	FCA-500-EU -> FLM-420/4-CON-D	258
ELS VdS 2489	7, 68	FCA-500-EU ->:CZM 0004 A	191
ENO 0000 A		FCH-320	257
TF2F	63	FCH-320 -> LSN 0300 A	222
ENO 0000 A/B		FCP-320	257
AT5000 IP/GPRS	61	FCP-320 -> LSN 0300 A	222
GÜ 101-B	66, 67	FCS-320-TM -> FLM-420/4-CON-D	259
MDL-F	62	FCS-320-TM ->:CZM 0004 A	192
UE-F-D/T	65	FCS-320-TP1 -> FLM-420/4-CON-D	260
ENO 0000 B		FCS-320-TP1 ->:CZM 0004 A	193
TF2F	64	FCS-320-TP2 -> FLM-420/4-CON-D	261

FCS-320-TP2 ->:CZM 0004 A	194	WMX-5000 -> FLM-420/4-CON-D	272
FCS-LHD-2 -> FLM-420/4-CON-D	248	<b>F</b>	
FCS-LWM-1 -> FLM-420/4-CON-D	254	FAA-420-RI-DIN ->	
FireRay 50RV/100RV -> FLM-420/4-CON-D	265	DF 1192	151
FIRERAY3000 -> FLM-420/4-CON-D	266, 267, 268	FAA-500	89, 220
FIRERAY3000 ->:CZM 0004 A	195, 196, 197	FAA-MSR 420	90, 221
FIRERAY5000 -> FLM-420/4-CON-D	269, 270	FAA-MSR-420	39, 40, 41
FIRERAY5000 ->:CZM 0004 A	198	FAD-0420	82
FLM-420/4-CON -> LSN 0300 A	212, 213	FAP-425	91, 222, 257
FLM-420-I2-D -> LSN 0300 A	205	FCA-500	58, 128, 129
FLM-420-I2-E/-W -> LSN 0300 A	206	FCA-500-EU	258
FLM-420-I8R1-S -> LSN 0300 A	207	FCH-320	91, 154, 222, 257
FLM-420-NAC-D -> LSN 0300 A	214, 215	FCP-320	91, 154, 222, 257
FLM-420-O1I1-D -> LSN 0300 A	205	FCS-LWM-1	57, 126, 127
FLM-420-O1I1-E -> LSN 0300 A	208	FNM-420-A-BS	87, 218
FLM-420-O8I2-S -> LSN 0300 A	209	FNM-420U-A-BS	87, 218
FLM-420-RHV -> LSN 0300 A	205	MS 400/MS 400 B	91, 154, 222, 257
FLM-420-RLV1-D -> LSN 0300 A	205	FAA-420-RI-ROW ->	
FLM-420-RLV1-E -> LSN 0300 A	210	FAA-MSR-420	39
FLM-I 420-S -> LSN 0300 A	211	FAA-500	
FMC-120 ->:CZM 0004 A	199	FAA-420-RI-DIN	89, 220
FMC-120-DKM -> FLM-420/4-CON-D	255	FAA-500 ->	
FMC-120-EST -> FLM-420/4-CON-D	255	LSN 0300 A	89
FMC-210-... -> LSN 0300 A	216	LSN 0300 A (EOL)	220
FMC-300 -> FLM-420/4-CON-D	256	FAA-500-R ->	
FMC-300 ->:CZM 0004 A	200	LSN 0300 A (EOL)	220
FNM-420-A/-B -> LSN 0300 A	217	FAA-MSR 420	
FNM-420-A-BS -> LSN 0300 A	218, 219	FAA-420-RI-DIN	90, 221
FNM-420U-A/-B -> LSN 0300 A	217	FAA-MSR 420 ->	
FNM-420U-A-BS -> LSN 0300 A	218, 219	63 R	17, 18
FNM-420V-A -> LSN 0300 A	217	837	17, 18
FNX-425U-RFRD ->:LSN 0300 A	241, 242	838	17, 18
FNX-425U-RFWH ->:LSN 0300 A	241, 242	858	17, 18
FNX-425U-WFRD ->:LSN 0300 A	241, 242	GT 40 R	17, 18
FNX-425U-WFWH ->:LSN 0300 A	241, 242	GT 42 R	17, 18
FWI-270 -> LSN 0300 A	243, 244, 245	GT 50 R	17, 18
KMX-5000 -> FLM-420/4-CON-D	272	GT 60 R	17, 18
LSN 0300 A:FNX-425U-RFRD	241, 242	GT 70 R	17, 18
LSN 0300 A:FNX-425U-RFWH	241, 242	GT 70 R 050.01 Ex	17, 18
LSN 0300 A:FNX-425U-WFRD	241, 242	LSN 0300 A	90
LSN 0300 A:FNX-425U-WFWH	241, 242	LSN 0300 A (EOL)	221
MS 400/MS 400 B -> FLM-420/4-CON-D	257	FAA-MSR 420 -> BTS 80 EMB	19, 20
MS 400/MS 400 B -> LSN 0300 A	222	FAA-MSR 420 -> BTS 80 FLB	19, 20
N4387A -> FLM-420/4-CON-D	262	FAA-MSR 420 -> TS 73 EMF	19, 20
OSID -> FLM-420/4-CON-D	250	FAA-MSR 420 -> TS 93 EMF	19, 20
Reset action	204	FAA-MSR 420 -> TS 93 GSR/EMF1	19, 20
thefirebeam -> FLM-420/4-CON-D	249		
Typ K -> FLM-420/4-CON-D	271		
UniVario -> FLM-420/4-CON-D	272		

FAA-MSR 420 -> TS 93 GSR/EMF2	19, 20	FCA-500-EU ->	
FAA-MSR-420		FLM-420/4-CON-D	128, 129
ED 100	15, 16	FLM-420/4-CON-D (EOL)	258
ED 250	15, 16	FCH-320	
FAA-420-RI-DIN	39, 40, 41	FAA-420-RI-DIN	91, 154, 222, 257
FAA-420-RI-ROW	39	FCH-320 ->	
Slimdrive EMD-F	21, 22	FLM-420/4-CON-D	154
Slimdrive EMD-F-IS	21, 22	FLM-420/4-CON-D (EOL)	257
TS 4000 E	23, 24	LSN 0300 A	91
TS 4000 EFS	23, 24	LSN 0300 A (EOL)	222
TS 4000 E-IS	23, 24	FCP-320	
TS 5000 E	23, 24	FAA-420-RI-DIN	91, 154, 222, 257
TS 5000 E-IS	23, 24	FCP-320 ->	
TS 5000 E-ISM	23, 24	FLM-420/4-CON-D	154
TS 550 E	23, 24	FLM-420/4-CON-D (EOL)	257
TSA 160 NT F	23, 24	LSN 0300 A	91
TSA 160 NT F-IS	23, 24	LSN 0300 A (EOL)	222
TSA 160 NT F-IS/TS	23, 24	FCP-500 ->	
FAD-0420		FLM-420/4-CON-D	128, 129
FAA-420-RI-DIN	82	FCS-320-TM ->	
FAD-420-HS-EN ->		CZM 0004 A	54
LSN 0300 A	82, 83	FCS-LWM-1	54
FAP-425		FLM-420/4-CON-D	130
FAA-420-RI-DIN	91, 222, 257	FLM-420/4-CON-D (EOL)	259
FAP-425 ->		FCS-320-TP1 ->	
FLM-420/4-CON-D	154	CZM 0004 A	55
FLM-420/4-CON-D (EOL)	257	FLM-420/4-CON-D	131, 133
LSN 0300 A	91	FLM-420/4-CON-D (EOL)	260
LSN 0300 A (EOL)	221, 222	FCS-320-TP2 ->	
FAP-520 ->		FLM-420/4-CON-D	132
LSN 0300 A	89	FLM-420/4-CON-D (EOL)	261
LSN 0300 A (EOL)	220	FCS-320-TP2->	
FAS-420 ->		CZM 0004 A	56
LSN 0300 A	84	FCS-LHD-2 ->	
LSN 0300 A (EOL)	223, 224	FLM-420/4-CON-D	125
FAS-420-TM ->		FLM-420/4-CON-D (EOL)	248
LSN 0300 A	85	FCS-LHD-2EN ->	
LSN 0300 A (EOL)	225, 226, 227, 228	FLM-420-I8R1-S	158, 159
FAT2002RE ->		FCS-LWM-1	
FPE-5000-UGM	123	FAA-420-RI-DIN	57, 126, 127
FBF 100 LSN ->		FCS-LWM-1 ->	
LSN 0300 A	96	CZM 0004 A	57
LSN 0300 A (EOL)	229, 230, 231, 232	FLM-420/4-CON-D	126, 127
FCA-500		FLM-420/4-CON-D (EOL)	254
FAA-420-RI-DIN	58, 128, 129	Fireray 100 RV ->	
FCA-500 ->		CZM 0004 A	45
CZM 0004 A	58	FLM-420/4-CON-D	138, 144
FCA-500-EU		Fireray 50 RV ->	
FAA-420-RI-DIN	258	CZM 0004 A	45

FLM-420/4-CON-D	138, 144	FCS-320-TP1 (EOL)	260
Fireray 50RV/100RV ->		FCS-320-TP2	132
FLM-420/4-CON-D (EOL)	265	FCS-320-TP2 (EOL)	261
FIRERAY3000 ->		FCS-LHD-2	125
CZM 0004 A	46, 47, 48	FCS-LHD-2 (EOL)	248
FLM-420/4-CON-D	139, 140, 141, 145, 146	FCS-LWM-1	126, 127
FLM-420/4-CON-D (EOL)	266, 267, 268	FCS-LWM-1 (EOL)	254
FIRERAY5000 ->		Fireray 100 RV	138, 144
CZM 0004 A	49, 50, 51	Fireray 50 RV	138, 144
FLM-420/4-CON-D	142, 143, 147, 148	Fireray 50RV/100RV (EOL)	265
FLM-420/4-CON-D (EOL)	269, 270	FIRERAY3000	139, 140, 141, 145, 146
FLM-420/4-CON ->		FIRERAY3000 (EOL)	266, 267, 268
LSN 0300 A	95	FIRERAY5000	142, 143, 147, 148
LSN 0300 A (EOL)	212, 213	FIRERAY5000 (EOL)	269, 270
FLM-420/4-CON-D		FMC-120-DKM	156
016519	134, 135, 136, 137	FMC-120-DKM (EOL)	255
016519 (EOL)	263, 264	FMC-120-EST (EOL)	255
016589	134, 135, 136, 137	FMC-300	152
016589 (EOL)	263, 264	FMC-300 (EOL)	256
2014/2 Ex	155	KMX-5000 (EOL)	272
2014/2 GLU-Ex	155	MS 400/MS 400 B	154
ADW 535-1 (EOL)	246	MS 400/MS 400 B (EOL)	257
ADW 535-2 (EOL)	247	N4387A	153
ALARMLINE II	125	N4387A (EOL)	262
ALARMLINE II (EOL)	248	NO-Relay	157
ASD 532 (EOL)	251	OSID (EOL)	250
ASD 535-1 (EOL)	252	thefirebeam (EOL)	249
ASD 535-2 (EOL)	253	TSZ 0400	36
DC1192, SB3	149, 150	Typ K (EOL)	271
DC1192, SB3 (EOL)	271	UniVario (EOL)	272
DF 1192	151	WMX-5000 (EOL)	272
DF1101-A-EX	149, 150	FLM-420-I2-D ->	
DF1101-A-EX (EOL)	271	FPP-3000	13
DM 1103B-X	149, 150	LSN 0300 A	69
DM 1103B-X (EOL)	271	LSN 0300 A (EOL)	205
DO1101-A-EX	149, 150	FLM-420-I2-E ->	
DO1101-A-EX (EOL)	271	FPP-3000	13
FAP-425	154	FLM-420-I2-E/-W	
FAP-425 (EOL)	257	TSZ 0400	37
FCA-500-EU	128, 129	FLM-420-I2-E/-W ->	
FCA-500-EU (EOL)	258	LSN 0300 A	70
FCH-320	154	LSN 0300 A (EOL)	206
FCH-320 (EOL)	257	FLM-420-I2-W ->	
FCP-320	154	FPP-3000	13
FCP-320 (EOL)	257	FLM-420-I8R1-S	
FCP-500	128, 129	FCS-LHD-2EN	158, 159
FCS-320-TM	130	FLM-420-I8R1-S ->	
FCS-320-TM (EOL)	259	FPP-3000	13
FCS-320-TP1	131, 133	LSN 0300 A	71

LSN 0300 A (EOL)	207	TS 5000 E	33, 34
FLM-420-NAC-D		TS 5000 E-IS	33, 34
FNM-320	170, 171	TS 5000 E-ISM	33, 34
FNS-320	168, 169	TS 550 E	33, 34
FPP-5000	43	TS 73 EMF	29, 30
PA 10	162, 163	TS 93 EMF	29, 30
PA 5	160, 161	TS 93 GSR/EMF1	29, 30
PB 2005	166, 167	TS 93 GSR/EMF2	29, 30
PY X-M-10-SSM R	164, 165	TSA 160 NT F	33, 34
PY X-M-10-SSM W	164, 165	TSA 160 NT F-IS	33, 34
ROLP-R-LX	170, 171	TSA 160 NT F-IS/TS	33, 34
ROLP-W-LX	170, 171	FLM-420-RHV ->	
SOL-LX	168, 169	63 R	27, 28
FLM-420-NAC-D ->		837	27, 28
FPP-3000	14	838	27, 28
FPP-5000	44	858	27, 28
LSN 0300 A	74, 75	GT 40 R	27, 28
LSN 0300 A (EOL)	214, 215	GT 42 R	27, 28
LSN 300 A, BCM 0000 B	76	GT 50 R	27, 28
FLM-420-O1I1-D ->		GT 60 R	27, 28
LSN 0300 A	78, 79	GT 70 R	27, 28
LSN 0300 A (EOL)	205	GT 70 R 050.01 Ex	27, 28
FLM-420-O1I1-E		LSN 0300 A	69
TSZ 0400	38	LSN 0300 A (EOL)	205
FLM-420-O1I1-E ->		FLM-420-RLE-S	
LSN 0300 A	80	LA	184
LSN 0300 A (EOL)	208	FLM-420-RLE-S ->	
FLM-420-O8I2-S ->		LSN 0300 A	77
FPP-3000	13	FLM-420-RLV1-D ->	
LSN 0300 A	72, 73	LSN 0300 A	69
LSN 0300 A (EOL)	209	LSN 0300 A (EOL)	205
FLM-420-RHV		FLM-420-RLV1-E	
ADW 535-1	178, 179	Plena	185
ADW 535-2	180, 181	FLM-420-RLV1-E ->	
ASD 532	176, 177	LSN 0300 A	70
ASD 535-1	172, 173	LSN 0300 A (EOL)	210
ASD 535-2	174, 175	FLM-420-RLV8-S	
ASD 535-3	172, 173	Plena	186
ASD 535-4	174, 175	FLM-420-RLV8-S ->	
BTS EMB	29, 30	LSN 0300 A	81
BTS FLB	29, 30	FLM-I 420-S ->	
ED 100	25, 26	LSN 0300 A	69
ED 250	25, 26	LSN 0300 A (EOL)	211
FRAY-ONE-EN	182, 183	FMC-120->	
Slimdrive EMD-F	31, 32	CZM 0004 A	59
Slimdrive EMD-F-IS	31, 32	FMC-120-DKM ->	
TS 4000 E	33, 34	FLM-420/4-CON-D	156
TS 4000 EFS	33, 34	FLM-420/4-CON-D (EOL)	255
TS 4000 E-IS	33, 34	FMC-120-EST ->	

FLM-420/4-CON-D (EOL)	255	FMF-FBF-FAT ->FMF-ADP-FBF	187
FMC-210-... ->		FMF-FIBS ->	
LSN 0300 A	100	FPE-5000-UGM	122, 123
LSN 0300 A (EOL)	216	IOS 0020 A	121
FMC-210-IP66-R ->		FNM-320 ->	
LSN 0300 A	101	FLM-420-NAC-D	170, 171
FMC-300 ->		NZM 0002 A	114, 115
FLM-420/4-CON-D	152	FNM-420-A/-B ->	
FLM-420/4-CON-D (EOL)	256	LSN 0300 A	86
FMC-300->		LSN 0300 A (EOL)	217
CZM 0004 A	60	FNM-420-A-BS	
FMC-420RW ->		FAA-420-RI-DIN	87, 218
LSN 0300 A	102	FNM-420-A-BS ->	
FMF-ADP ->		LSN 0300 A	87, 88
FPE-5000-UGM	122, 123	LSN 0300 A (EOL)	218, 219
IOS 0020 A	121	FNM-420U-A/-B ->	
FMF-ADP-FAT		LSN 0300 A	86
FMF-FAT	187	LSN 0300 A (EOL)	217
FMF-FBF-FAT	187	FNM-420U-A-BS	
FMF-FAT ->		FAA-420-RI-DIN	87, 218
FPE-5000-UGM	122	FNM-420U-A-BS ->	
IOS 0020 A	121	LSN 0300 A	87, 88
FMF-FAT ->FMF-ADP-FBF	187	LSN 0300 A (EOL)	218, 219
FMF-FBF-FAT ->		FNM-420V-A ->	
FPE-5000-UGM	122, 123	LSN 0300 A	86
IOS 0020 A	121	LSN 0300 A (EOL)	217
		FNS-320 ->	
		FLM-420-NAC-D	168, 169
		NZM 0002 A	111, 112, 113
		FNS-P400RTH ->	
		RMH 0002 A	119
		FNX-425U-RFRD ->	
		LSN 0300 A	98, 99
		LSN 0300 A (EOL)	241, 242
		FNX-425U-RFWH ->	
		LSN 0300 A	98, 99
		LSN 0300 A (EOL)	241, 242
		FNX-425U-WFRD ->	
		LSN 0300 A	98, 99
		LSN 0300 A (EOL)	241, 242
		FNX-425U-WFWH ->	
		LSN 0300 A	98, 99
		LSN 0300 A (EOL)	241, 242
		FPE-5000-UGM	
		FAT2002RE	123
		FMF-ADP	122, 123
		FMF-FAT	122
		FMF-FBF-FAT	122, 123
		FMF-FIBS	122, 123



FPP-3000			
FLM-420-I2-D	13		
FLM-420-I2-E	13		
FLM-420-I2-W	13		
FLM-420-I8R1-S	13		
FLM-420-NAC-D	14		
FLM-420-O8I2-S	13		
FPP-5000			
FLM-420-NAC-D	44		
FPP-5000 ->			
FLM-420-NAC-D	43		
FPP-5000-TI			
BCM-0000-B	11		
FPP-5000-TI13			
BCM-0000-B	12		
FRAY-ONE-EN ->			
FLM-420-RHV	182, 183		
FWI-270 ->			
LSN 0300 A	105		
LSN 0300 A (EOL)	243, 244, 245		
<b>G</b>			
GSME-L3 ->			
LSN 0300 A	92		
GT 40 R ->			
FAA-MSR 420	17, 18		
FLM-420-RHV	27, 28		
GT 42 R ->			
FAA-MSR 420	17, 18		
FLM-420-RHV	27, 28		
GT 50 R ->			
FAA-MSR 420	17, 18		
FLM-420-RHV	27, 28		
GT 60 R ->			
FAA-MSR 420	17, 18		
FLM-420-RHV	27, 28		
GT 63 R ->			
FAA-MSR 420	17, 18		
FLM-420-RHV	27, 28		
GT 70 R ->			
FAA-MSR 420	17, 18		
FLM-420-RHV	27, 28		
GT 70 R 050.01 Ex ->			
FAA-MSR 420	17, 18		
FLM-420-RHV	27, 28		
GÜ 101-B ->			
ENO 0000 A/B	66, 67		
<b>I</b>			
IOS 0020 A			
FMF-ADP		121	
FMF-FAT		121	
FMF-FBF-FAT		121	
FMF-FIBS		121	
Plena		120	
<b>K</b>			
KMX-5000 ->			
FLM-420/4-CON-D (EOL)		272	

<b>L</b>			
LA ->			
FLM-420-RLE-S	184	FLM-420-RLV1-D	69
LSN 0300 A (FLM-420-RLE-S)	97	FLM-420-RLV1-D (EOL)	205
LSN 0300 A		FLM-420-RLV1-E	70
ATB 420 LSNi	93	FLM-420-RLV1-E (EOL)	210
ATB 420 LSNi (EOL)	233, 234, 235, 236	FLM-420-RLV8-S	81
ATG 420 LSNi	94	FLM-I 420-S	69
ATG 420 LSNi (EOL)	237, 238, 239, 240	FLM-I 420-S (EOL)	211
C31B	103, 104	FMC-210-...	100
FAA-500	89	FMC-210-... (EOL)	216
FAA-500 (EOL)	220	FMC-210-IP66-R	101
FAA-500-R (EOL)	220	FMC-420RW	102
FAA-MSR 420	90	FNM-420-A/-B	86
FAA-MSR 420 (EOL)	221	FNM-420-A/-B (EOL)	217
FAD-420-HS-EN	82, 83	FNM-420-A-BS	87, 88
FAP-425	91	FNM-420-A-BS (EOL)	218, 219
FAP-425 (EOL)	221, 222	FNM-420U-A/-B	86
FAP-520	89	FNM-420U-A/-B (EOL)	217
FAP-520 (EOL)	220	FNM-420U-A-BS	87, 88
FAS-420	84	FNM-420U-A-BS (EOL)	218, 219
FAS-420 (EOL)	223, 224	FNM-420V-A	86
FAS-420-TM	85	FNM-420V-A (EOL)	217
FAS-420-TM (EOL)	225, 226, 227, 228	FNX-425U-RFRD	98, 99
FBF 100 LSN	96	FNX-425U-RFRD (EOL)	241, 242
FBF 100 LSN (EOL)	229, 230, 231, 232	FNX-425U-RFWH	98, 99
FCH-320	91	FNX-425U-RFWH (EOL)	241, 242
FCH-320 (EOL)	222	FNX-425U-WFRD	98, 99
FCP-320	91	FNX-425U-WFRD (EOL)	241, 242
FCP-320 (EOL)	222	FNX-425U-WFWH	98, 99
FLM-420/4-CON	95	FNX-425U-WFWH (EOL)	241, 242
FLM-420/4-CON (EOL)	212, 213	FWI-270	105
FLM-420-I2-D	69	FWI-270 (EOL)	243, 244, 245
FLM-420-I2-D (EOL)	205	GSME-L3	92
FLM-420-I2-E/-W	70	LA (FLM-420-RLE-S)	97
FLM-420-I2-E/-W (EOL)	206	MS 400/MS 400 B	91
FLM-420-I8R1-S	71	MS 400/MS 400 B (EOL)	222
FLM-420-I8R1-S (EOL)	207		
FLM-420-NAC-D	74, 75	<b>M</b>	
FLM-420-NAC-D (EOL)	214, 215	MDL-F ->	
FLM-420-O1I1-D	78, 79	ENO 0000 A/B	62
FLM-420-O1I1-D (EOL)	205	MS 400	
FLM-420-O1I1-E	80	TSZ 0400 (FCP-O320 / FCH-T320 FSA)	35
FLM-420-O1I1-E (EOL)	208	MS 400/MS 400 B	
FLM-420-O8I2-S	72, 73	FAA-420-RI-DIN	91, 154, 222, 257
FLM-420-O8I2-S (EOL)	209	MS 400/MS 400 B ->	
FLM-420-RHV	69	FLM-420/4-CON-D	154
FLM-420-RHV (EOL)	205	FLM-420/4-CON-D (EOL)	257
FLM-420-RLE-S	77	LSN 0300 A	91
		LSN 0300 A (EOL)	222

**N**

N4387A ->	
FLM-420/4-CON-D	153
FLM-420/4-CON-D (EOL)	262
NO-Relay ->	
FLM-420/4-CON-D	157
NZM 0002 A	
FNM-320	114, 115
FNS-320	111, 112, 113
NZM 0002 A	110
PA 10	108, 109
PA 5	106, 107
PB 2005	116, 117, 118
ROLP-W-LX	114, 115
SOL-LX	111, 112, 113
NZM 0002 A ->	
NZM 0002 A	110

**O**

OSID ->	
FLM-420/4-CON-D (EOL)	250

**P**

PA 10 ->	
FLM-420-NAC-D	162, 163
NZM 0002 A	108, 109
PA 5 ->	
FLM-420-NAC-D	160, 161
NZM 0002 A	106, 107
PB 2005 ->	
FLM-420-NAC-D	166, 167
NZM 0002 A	116, 117, 118
Plena ->	
FLM-420-RLV1-E	185
FLM-420-RLV8-S	186
IOS 0020 A	120
PY X-M-10-SSM R ->	
FLM-420-NAC-D	164, 165
PY X-M-10-SSM W ->	
FLM-420-NAC-D	164, 165

**R**

Redundancy	
ENO	67
LSN 0300 A	97
NZM 0002 A	110
Panel controller	97

Reset action	204
RMH 0002 A	
FNS-P400RTH	119
ROLP-R-LX ->	
FLM-420-NAC-D	170, 171
ROLP-W-LX ->	
FLM-420-NAC-D	170, 171
NZM 0002 A	114, 115
<b>S</b>	
Slimdrive EMD-F ->	
FAA-MSR-420	21, 22
FLM-420-RHV	31, 32
Slimdrive EMD-F-IS ->	
FAA-MSR-420	21, 22
FLM-420-RHV	31, 32
SOL-LX ->	
FLM-420-NAC-D	168, 169
NZM 0002 A	111, 112, 113

<b>T</b>			
TF2F ->			
ENO 0000 A	63		
ENO 0000 B	64		
thefirebeam ->			
FLM-420/4-CON-D (EOL)	249		
TS 4000 E ->			
FAA-MSR-420	23, 24		
FLM-420-RHV	33, 34		
TS 4000 EFS ->			
FAA-MSR-420	23, 24		
FLM-420-RHV	33, 34		
TS 4000 E-IS ->			
FAA-MSR-420	23		
FLM-420-RHV	33, 34		
TS 4000 E-IS->			
FAA-MSR-420	24		
TS 5000 E ->			
FAA-MSR-420	23, 24		
FLM-420-RHV	33, 34		
TS 5000 E-IS ->			
FAA-MSR-420	23, 24		
FLM-420-RHV	33, 34		
TS 5000 E-ISM ->			
FAA-MSR-420	23, 24		
FLM-420-RHV	33, 34		
TS 550 E ->			
FAA-MSR-420	23, 24		
FLM-420-RHV	33, 34		
TS 73 EMF ->			
FAA-MSR 420	19, 20		
FLM-420-RHV	29, 30		
TS 93 EMF ->			
FAA-MSR 420	19, 20		
FLM-420-RHV	29, 30		
TS 93 GSR/EMF1 ->			
FAA-MSR 420	19, 20		
FLM-420-RHV	29, 30		
TS 93 GSR/EMF2 ->			
FAA-MSR 420	19, 20		
FLM-420-RHV	29, 30		
TSA 160 NT F ->			
FAA-MSR-420	23, 24		
FLM-420-RHV	33, 34		
TSA 160 NT F-IS ->			
FAA-MSR-420	23, 24		
FLM-420-RHV	33, 34		
TSA 160 NT F-IS/TS ->			
FAA-MSR-420	23, 24		
		FLM-420-RHV	33, 34
		TSZ 0400 ->	
		FLM-420/4-CON-D	36
		FLM-420-I2-E/-W	37
		FLM-420-O1I1-E	38
		MS 400 (FCP-O320 / FCH-T320 FSA)	35
		Typ K ->	
		FLM-420/4-CON-D (EOL)	271
		<b>U</b>	
		UE-F-D/T ->	
		ENO 0000 A/B	65
		UniVario ->	
		FLM-420/4-CON-D (EOL)	272
		<b>W</b>	
		WMX-5000 ->	
		FLM-420/4-CON-D (EOL)	272







**Bosch Sicherheitssysteme GmbH**

Robert-Bosch-Ring 5

85630 Grasbrunn

Germany

**[www.boschsecurity.com](http://www.boschsecurity.com)**

© Bosch Sicherheitssysteme GmbH, 2023

**Building solutions for a better life.**

202307120830