

AVENAR panel series

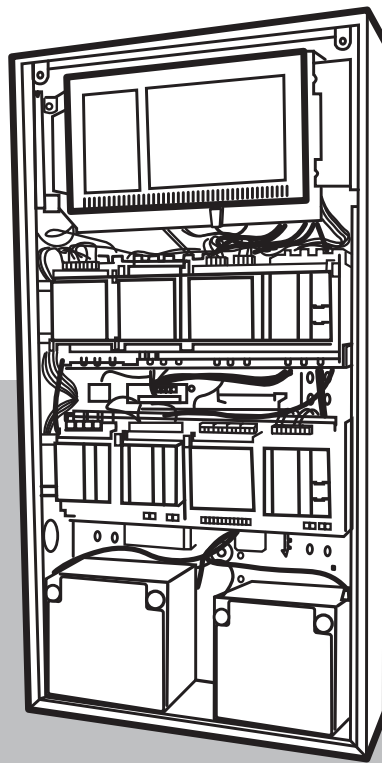

hr

Upute za spajanje

Sadržaj

1	Obavijesti	4
1.1	Sadržaj	4
1.2	Informacije o proizvodu	5
1.3	Važne napomene	5
1.4	Napomene za korisnika	5
1.4.1	Simboli poglavlja	7
1.4.2	Simboli za spajanje	7
1.4.3	Napajanje i ožičenje	8
1.5	Vrijednosti otpora	8
2	Wiring	10
2.1	FPP-5000 Power supply	11
2.2	FPP-3000 Power supply (ZSP135-DR-5A-3/ZSP135-OUT6)	13
2.3	DIBT	15
2.4	Functional Modules	42
2.4.1	BCM-000-B	43
2.4.2	CZM 0004 A	45
2.4.3	ENO 0000 A/B	61
2.4.4	LSN 0300 A	68
2.4.5	NZM 0002 A	106
2.4.6	RMH 0002 A	119
2.4.7	IOS 0020 A	120
2.4.8	FPE-5000-UGM	122
2.5	Interface Modules	124
2.5.1	FLM-420-4/CON-D/S	125
2.5.2	FLM-420-I8R1-S	158
2.5.3	FLM-420-NAC-D/S	160
2.5.4	FLM-420-RHV	172
2.5.5	FLM-420-RLE-S	184
2.5.6	FLM-420-RLV1-E	185
2.5.7	FLM-420-RLV8-S	186
2.5.8	FMF-ADP-FBF/FMF-ADP-TTY	187
2.6	EOL	188
2.6.1	CZM 0004 A	189
2.6.2	LSN 0300 A	201
2.6.3	FLM-420/4-CON-S/D	246
		273

1 Obavijesti

1.1 Sadržaj

U ovom priručniku za spajanje električnih instalacija opisuje se princip spajanja perifernih uređaja na vatrodojavnu centralu. Nisu u obzir uzeti nacionalni i lokalni propisi. Nacionalnim i lokalnim propisima mogu biti određeni dodatni spojevi.

**Alarm obavijesti!**

Priključci navedeni u ovom dokumentu odnose se i na kontroler AVENAR panel 2000, pod uvjetom da je pojedinačne komponente odobrila tvrtka Bosch Sicherheitssysteme GmbH kao proširenja za kontroler AVENAR panel 2000.

**Alarm obavijesti!**

Priključci LSN 0300 A navedeni u ovom dokumentu odnose se i na modul LSN 1500 A. Za modul LSN 1500 A pri instalaciji u Njemačkoj, gdje je nužna sukladnost s normom VdS 2540, imajte na umu da AUX linija i LSN linija moraju biti u zasebnim kabelima.

1.2 Informacije o proizvodu

- U priloženom priručniku za instalaciju naći ćete upute za instaliranje pojedinačnih komponenti upravljačke ploče za dojavu požara.
- Više informacija (korisnički priručnici, upute za umrežavanje, priručnik za sustav) dostupno je na internetu na adresi: www.boschsecurity.com

1.3 Važne napomene

- Koristite isključivo materijale za instalaciju koje je preporučila tvrtka Bosch Security Systems.
- Preinake ili radove na postavljanju izvodite isključivo uz propisno uzemljenje pomoću zaštitne vodljive narukvice.
- Sastavljanje i postavljanje smije izvoditi samo stručno osoblje.
- Pridržavajte se lokalnih propisa i zakona o priključivanju.



Alarm opasnosti!

Dotirivanje komponenata pod naponom može imati smrtne posljedice.
Obavezno isključite napajanje prije izvođenja instalacije.

Oklopljeni kabel

Oklopljeni kabel nužan je za sve dvožilne spojeve s modulom CZM 0004 A te za povezivanje sljedećih proizvoda:

- FBF 100 LSN
- FMF-ADP, FMF-FAT, FMF-FBF-FAT, FMF-FIBS-A4, FMF-FIBS-A3

U sljedećem primjeru ožičenja prikazuje se kako postaviti oklopljeni kabel.

Alarm obavijesti!

Ako je potrebno spojiti oklopljeni kabel za kabel LSN-a, postupite u skladu sa specifikacijama LSN-a.

- Oklopljeni kabel LSN-a na strani centrale spojite na odgovarajući funkcionalni priključak uzemljenja:

dva spoja na početku i kraju petlje

jedan spoj na početku grane

- Provucite kroz oklopljeni kabel na svim perifernim uređajima LSN-a pomoću predviđenih priključaka

- Nije dopušteno nikakvo dodatno priključivanje oklopljenog kabela LSN-a na priključke uzemljenja na bilo kojoj lokaciji, kao ni na drugi električni potencijal



1.4 Napomene za korisnika

Upute za spajanje strukturirane su na sljedeći način:

- Poglavlje Ožičenje sortirano je prema uređajima na koje je periferni uređaj spojen. Spojna shema prikazuje izravne veze od jednog uređaja do drugog (nema kaskadnih veza).
- Pronađite sve spojne sheme s dodatnim modulima EOL za nadzor postupnog povećanja otpora voda u odjeljku EOL.

Da biste pronašli određenu spojnu shemu upotrijebite i sljedeće:





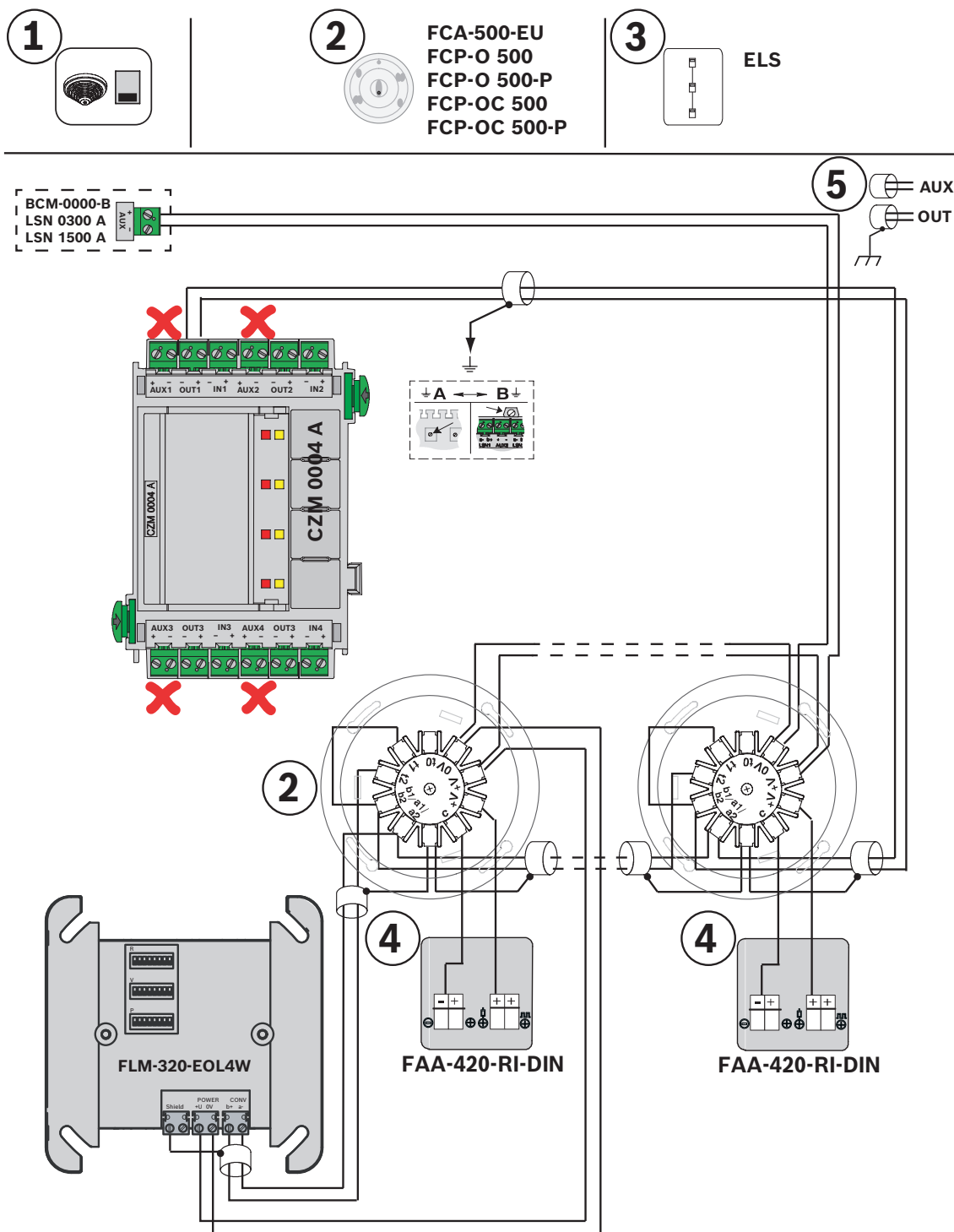







- sadržaj na početku poglavlja Ožičenje te na početku odjeljaka Moduli funkcija, Moduli sučelja i EOL.
- Index (jezično neutralan)
- i pretraživanje cijelog teksta.

Pogledajte sljedeći primjer spojne sheme:













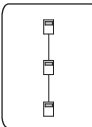
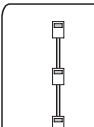
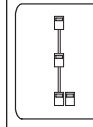
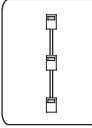
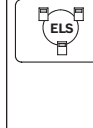

1	Simboli poglavlja (<i>Simboli poglavlja, stranica 7</i>)
2	Periferni uređaji koji se mogu spojiti
3	Simboli za spajanje (<i>Simboli za spajanje, stranica 7</i>)
4	Opcionalne komponente
5	Napajanje i ožičenje (<i>Napajanje i ožičenje, stranica 8</i>)

1.4.1 Simboli poglavlja





	Automatski detektori		Kontroleri za rukovanje sustavom i prikaz		Pisač
	Izvor napajanja		Funkcionalni moduli		Vatrogasna oprema
	Moduli sučelja		Sustavi za gašenje požara		Ručni javljači požara
	Signalni uređaji		Kontrole vrata		Uređaji za prijenos

1.4.2 Simboli za spajanje

	Obvezno ožičenje		Opcionalno ožičenje		Nije dopušteno
	Redundancija		Ožičenje petlje		Ožičenje petlje s redundantnim elementom
	Ožičenje mreže s jednim izlazom prema vanjskim mrežama		Ožičenje redundantne mreže s jednim izlazom prema vanjskim mrežama		Ožičenje mreže s jednim izlazom prema vanjskim mrežama s redundantnim elementom
	Ožičenje redundantne mreže s jednim izlazom prema vanjskim mrežama s redundantnim elementom	ELS	Ovo je ožičenje sukladno normi VdS 2489 / VdS 2540 / VdS 2541 / VdS 2543. ELS pokrata je za Extended Line Supervision, što označava nadzor postupnog kratkog spoja i postupnog povećanja otpora voda. Ovo ožičenje pruža funkciju ELS. Postupni kratki spoj otkrivaju sljedeći moduli: LSN 0300 A, LSN 1500 A i BCM-0000-B ako se koristi FPP-5000-TI13.		Ovo ožičenje petlje sukladno je standardu VdS 2489 / VdS 2540 / VdS 2541 / VdS 2543. Ono pruža funkciju ELS. Dodatni moduli EOL nisu nužni.
	Sinkronizacija		Potencijalno eksplozivna područja		Vatrodajavna centrala
	Samostalna vatrodajavna centrala		Samostalna vatrodajavna centrala s redundancijom		Za postolja detektora: spojna je shema valjana samo za postolja u kojima je instaliran detektor.

EN 54-2, DIBT itd.	U slučaju kada je nužno slaganje s ovim standardom, upotrijebite navedenu spojnu shemu.				
--------------------	---	--	--	--	--

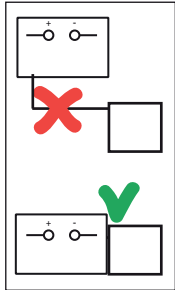
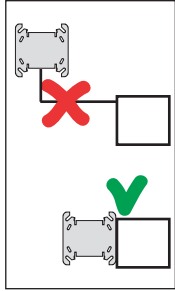
1.4.3 Napajanje i ožičenje

	Potreban je dvožilni kabel.
	Potreban je oklopljeni 2-žilni kabel.
	Kućište proizvoda koje sadrži napajanje mora se postaviti u ravnini s elementom.
	Modul sučelja potrebno je ugraditi u ravnini.
 Reset action	Pogledajte ožičenje u ovom priručniku. Da bi se uređaj mogao automatski resetirati, morate implementirati radnju resetiranja.

1.5 Vrijednosti otpora

Sljedeća tablica sadrži prikaz kodiranja otpornika u boji. Otpornici obloženi metalom koji su isporučeni s proizvodom imaju 5 traka u boji koje označavaju vrijednost otpora.

Boja	1. traka	2. traka	3. traka	4. traka (multiplikator)	5. traka (tolerancija)
Srebrna				10^{-2}	$\pm 10\%$
Zlatna				10^{-1}	$\pm 5\%$
Crna		0	0	10^0	
Smeđa	1	1	1	10^1	$\pm 1\%$
Crvena	2	2	2	10^2	$\pm 2\%$
Narančasta	3	3	3	10^3	$\pm 0.05\%$
Žuta	4	4	4	10^4	$\pm 0.02\%$

Boja	1. traka	2. traka	3. traka	4. traka (multiplikator)	5. traka (tolerancija)
Zelena	5	5	5	10 ⁵	±0.5%
Plava	6	6	6	10 ⁶	±0.25%
Ljubičasta	7	7	7	10 ⁷	±0.1%
Siva	8	8	8	10 ⁸	±0.01%
Bijela	9	9	9	10 ⁹	

U skladu sa standardom DIN EN 60062:2017

Narančasta – bijela – crna – smeđa – smeđa: otpornik od 3,9 kilooma s 1 % tolerancije,

Crvena – crvena – crna – smeđa – smeđa: otpornik od 2,2 kilooma s 1 % tolerancije.

2 Wiring



FPP-5000 Power supply, stranica 11

FPP-3000 Power supply (ZSP135-DR-5A-3/ZSP135-OUT6), stranica 13

DIBT, stranica 15

Functional Modules, stranica 42

BCM-000-B, stranica 43

CZM 0004 A, stranica 45

ENO 0000 A/B, stranica 61

LSN 0300 A, stranica 68

NZM 0002 A, stranica 106

RMH 0002 A, stranica 119

IOS 0020 A, stranica 120

FPE-5000-UGM, stranica 122

Interface Modules, stranica 124

FLM-420-4/CON-D/S, stranica 125

FLM-420-I8R1-S, stranica 158

FLM-420-NAC-D/S, stranica 160

FLM-420-RHV, stranica 172

FLM-420-RLE-S, stranica 184

FLM-420-RLV1-E, stranica 185

FLM-420-RLV8-S, stranica 186

FMF-ADP-FBF/FMF-ADP-TTY, stranica 187

EOL, stranica 188

CZM 0004 A, stranica 189

LSN 0300 A, stranica 201

FLM-420/4-CON-S/D, stranica 246

2.1 FPP-5000 Power supply

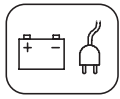

FPP-5000-TI

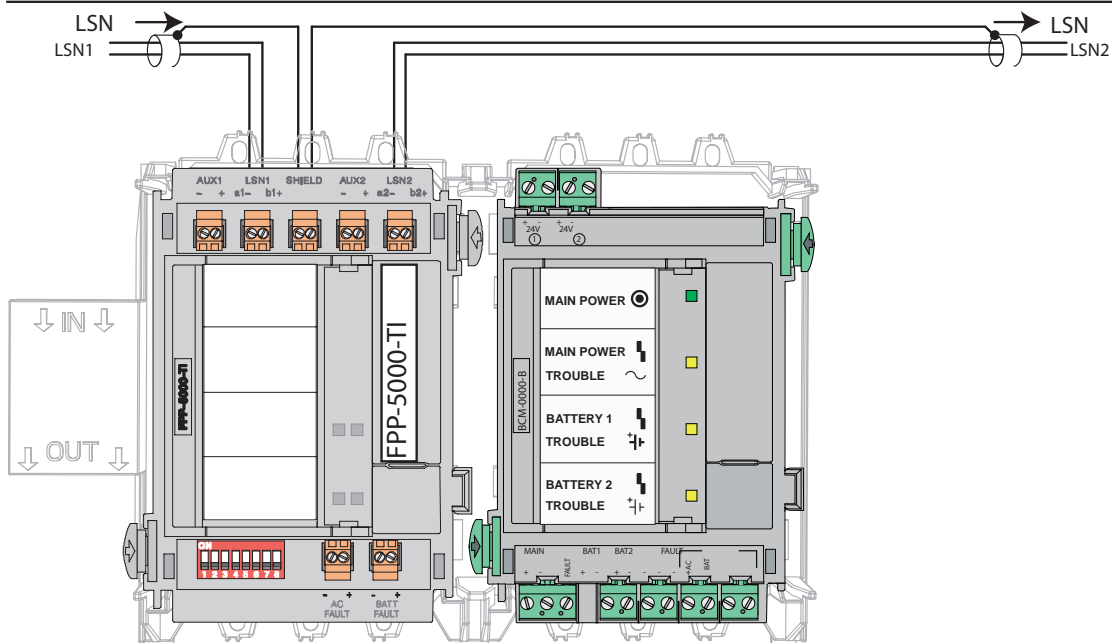

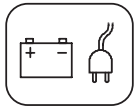

FPP-5000-TI13

ELS

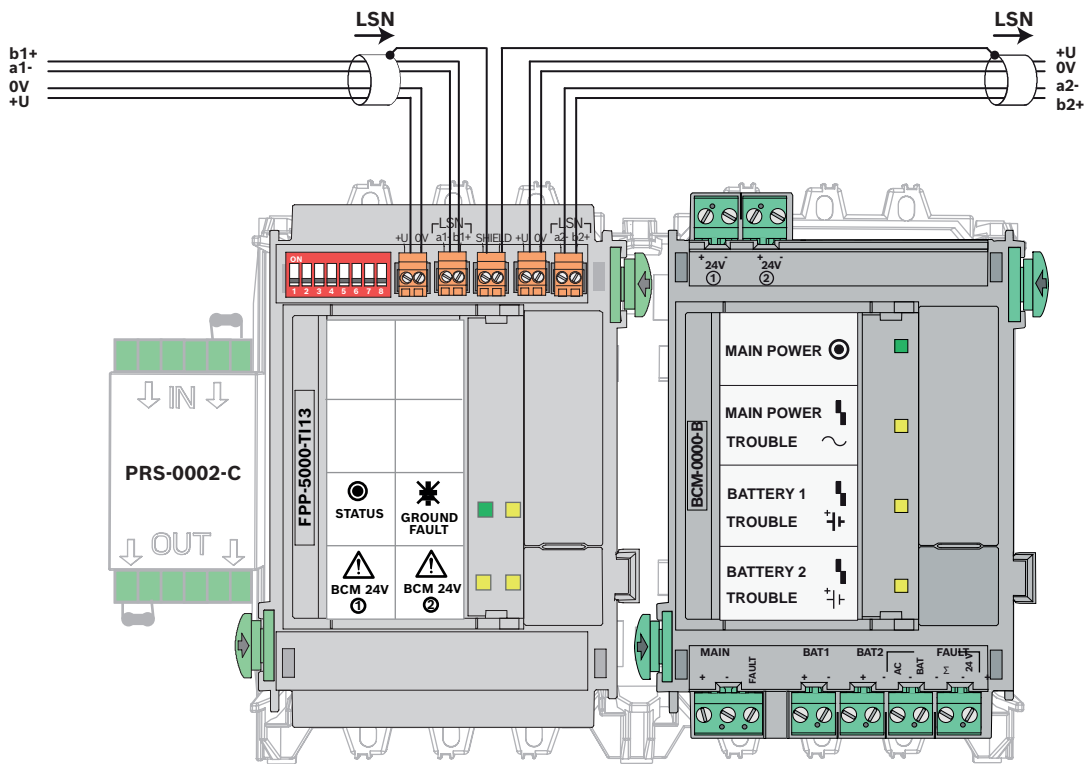

2.2 FPP-3000 Power supply (ZSP135-DR-5A-3/ZSP135-OUT6)

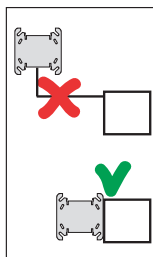
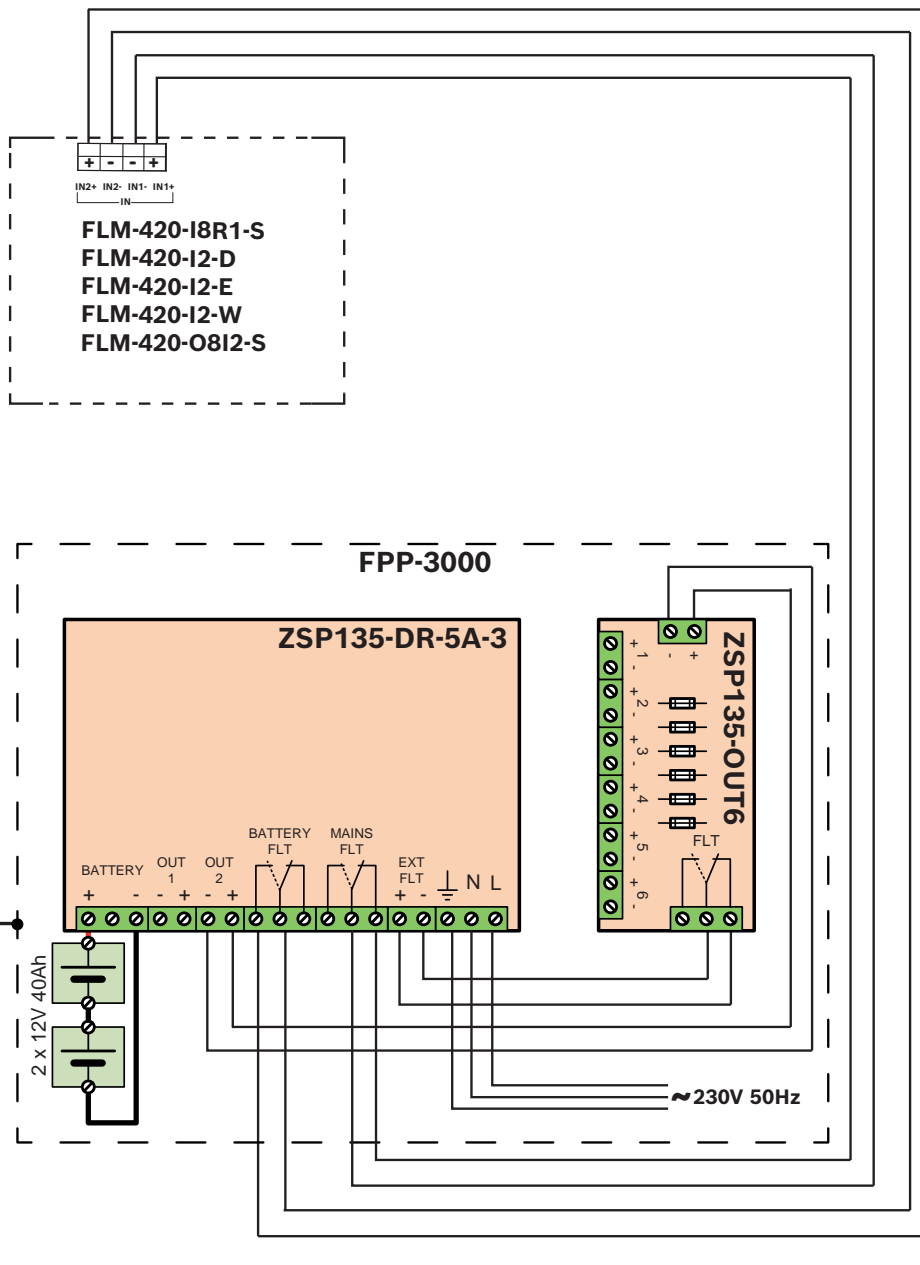
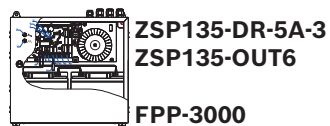
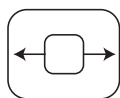

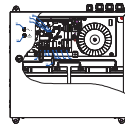
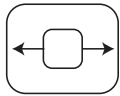

ZSP135-DR-5A-3
ZSP135-OUT6
FPP-3000

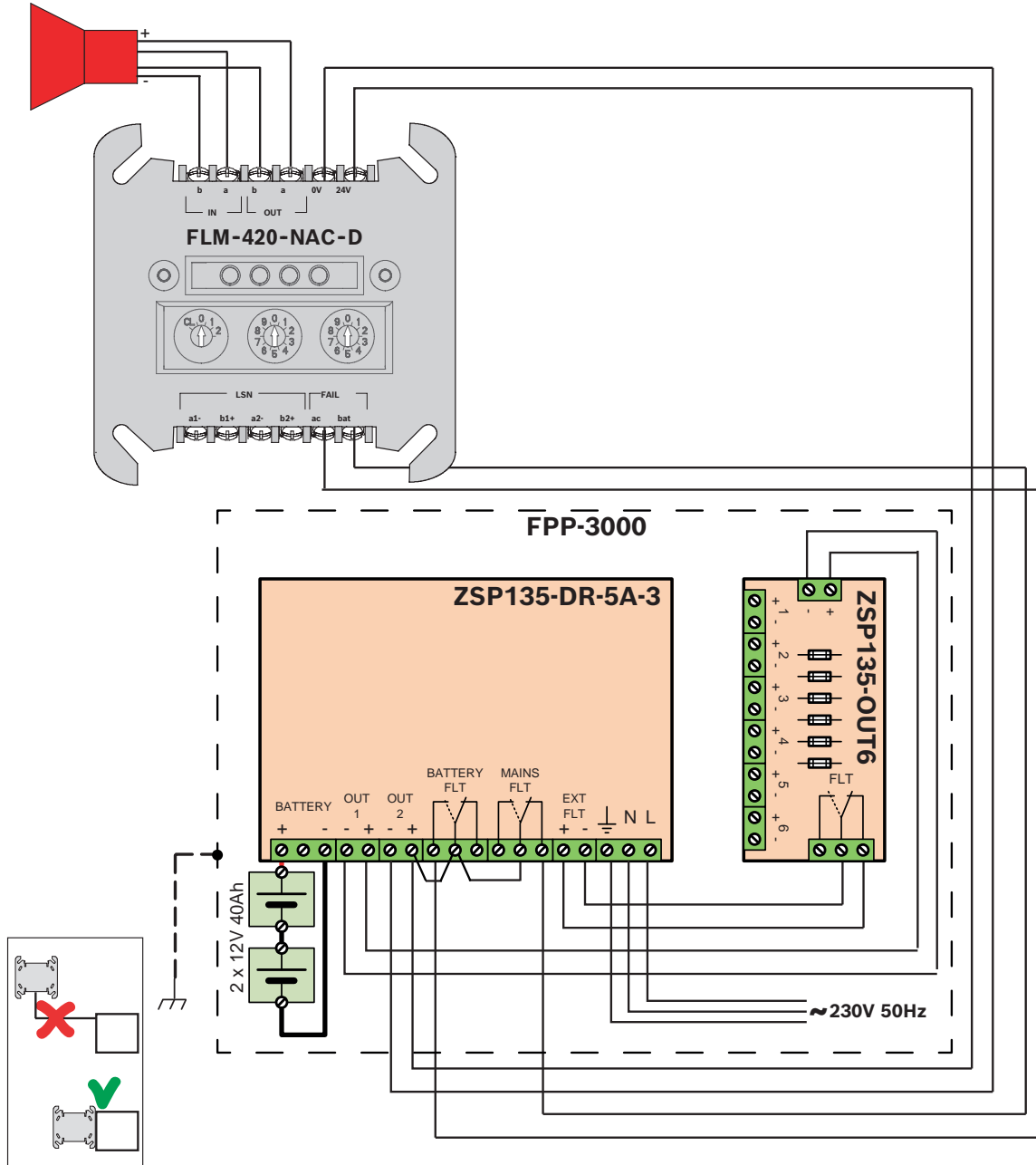

2.3 DIBT



**ED 100
ED 250
(+Upgrade Card B)**

DIBT

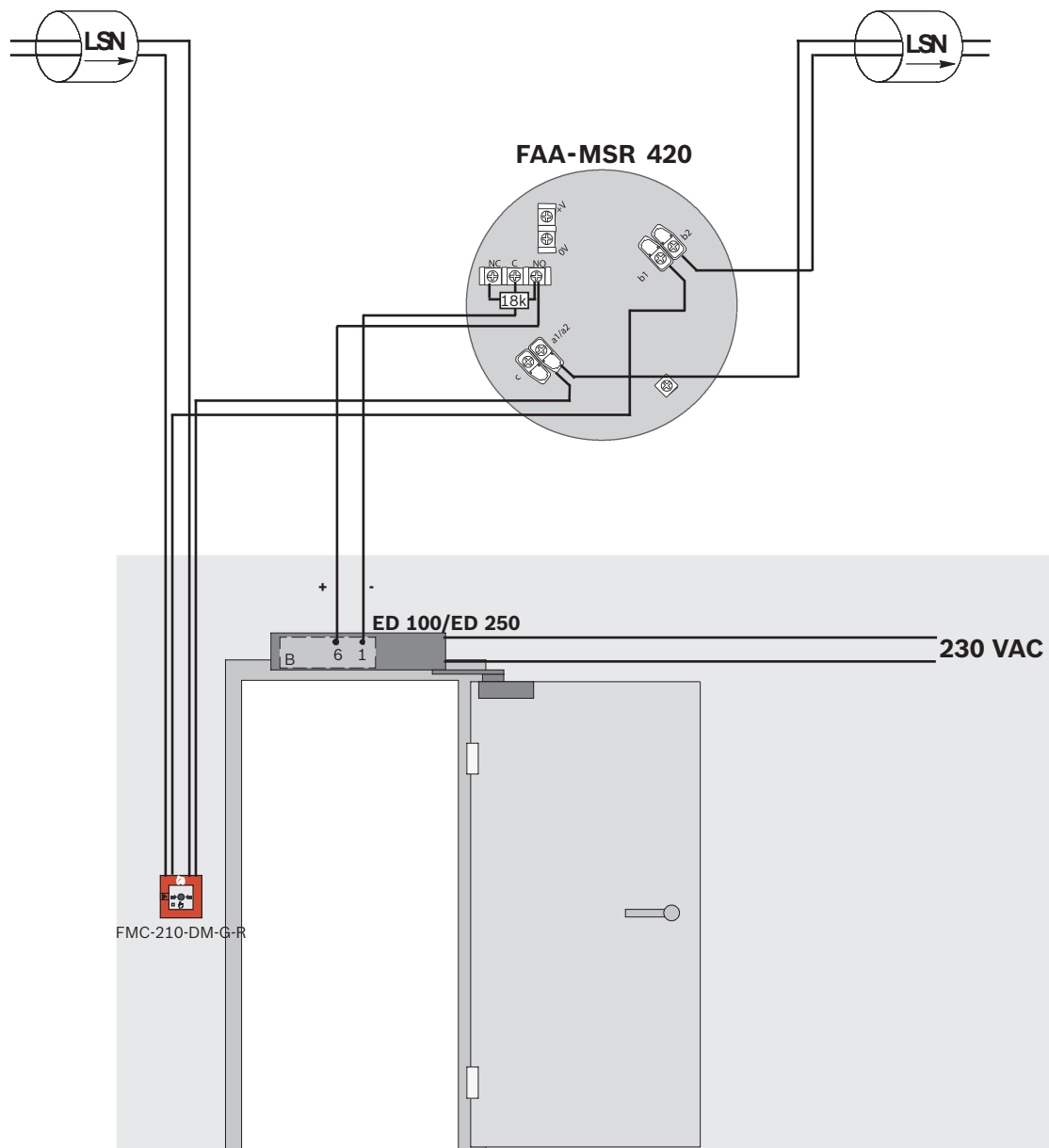



ED 100
ED 250
(+Upgrade Card B)

DIBT

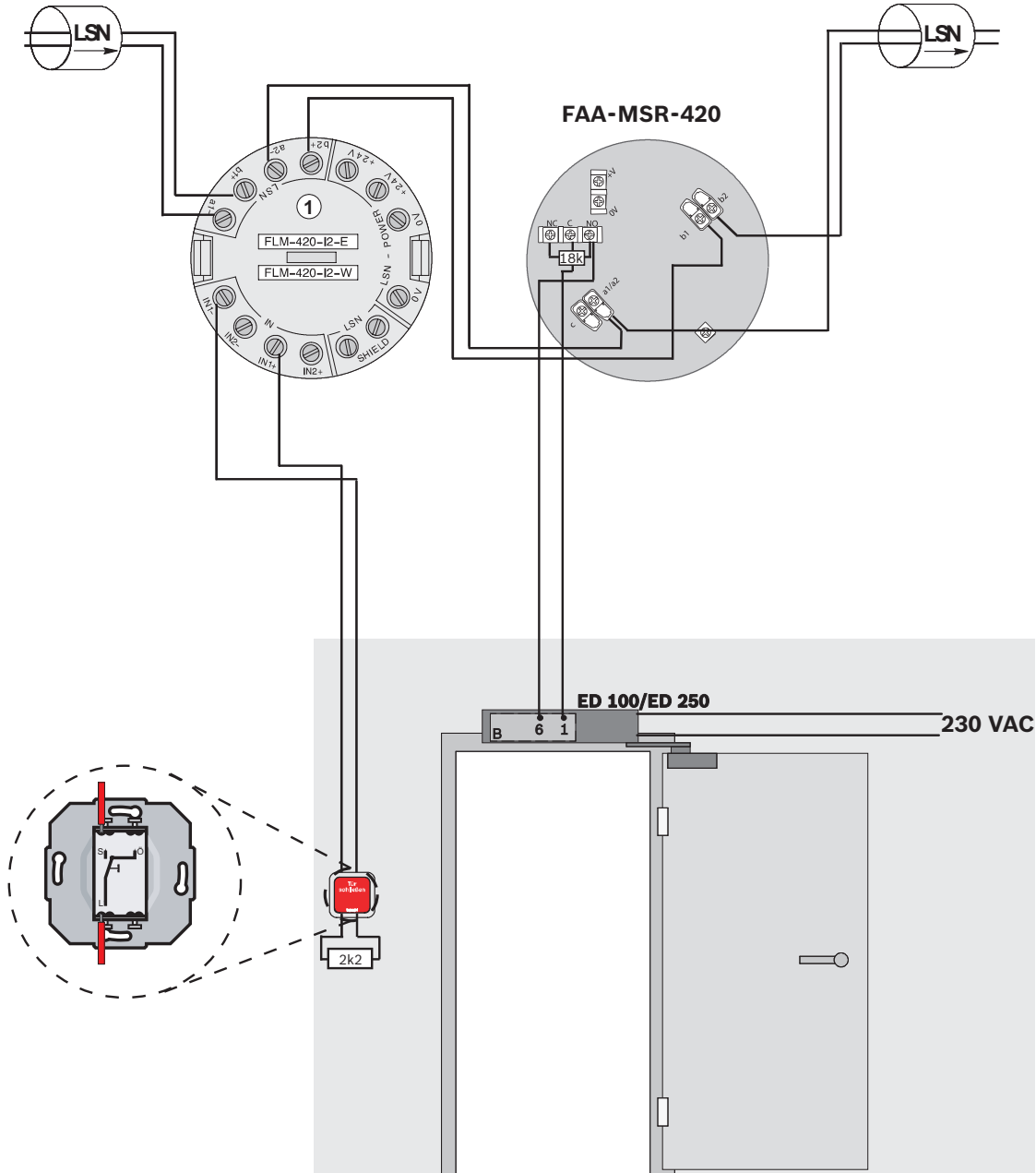

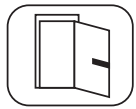

DIBT

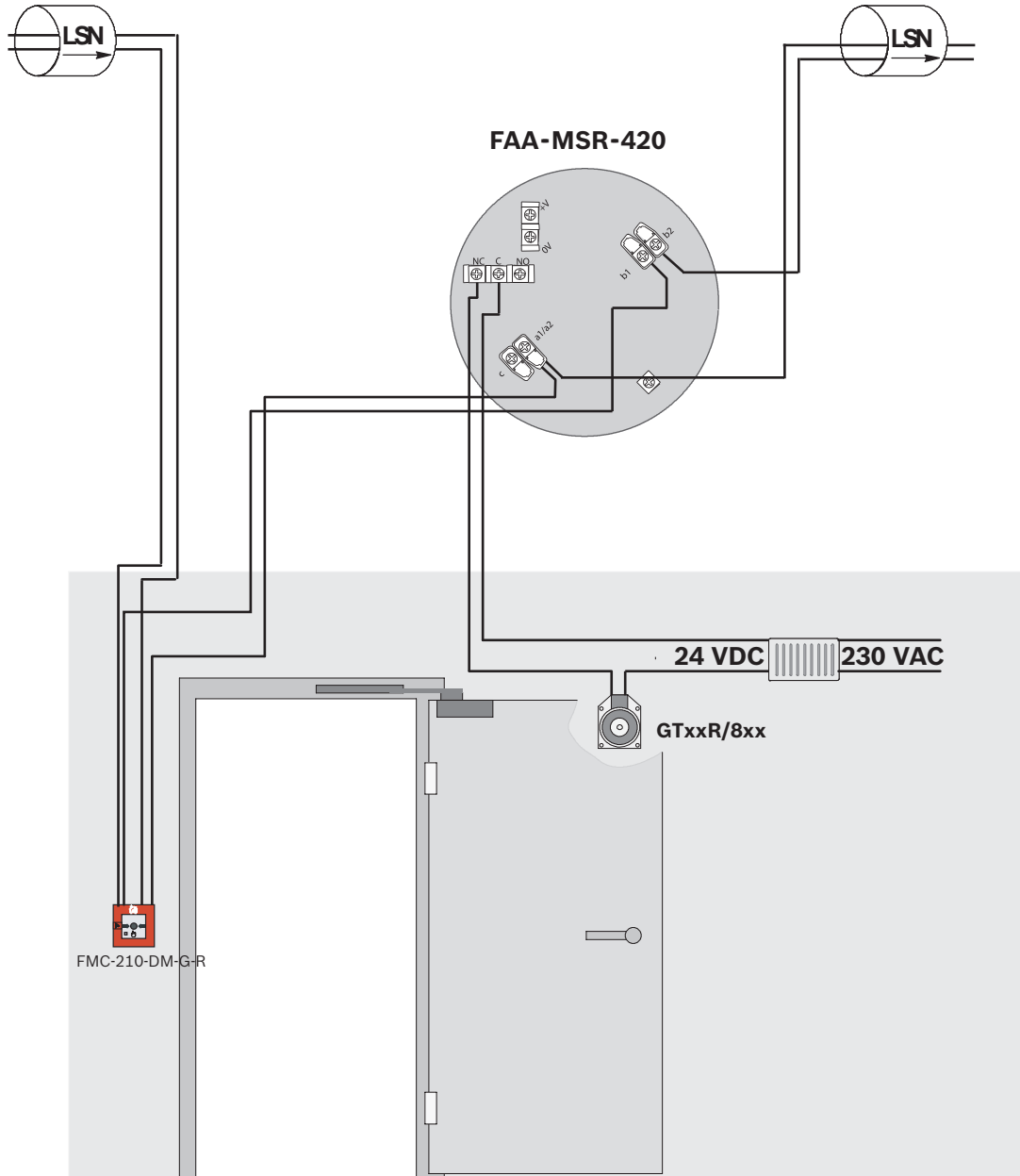

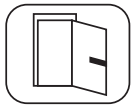

DIBT

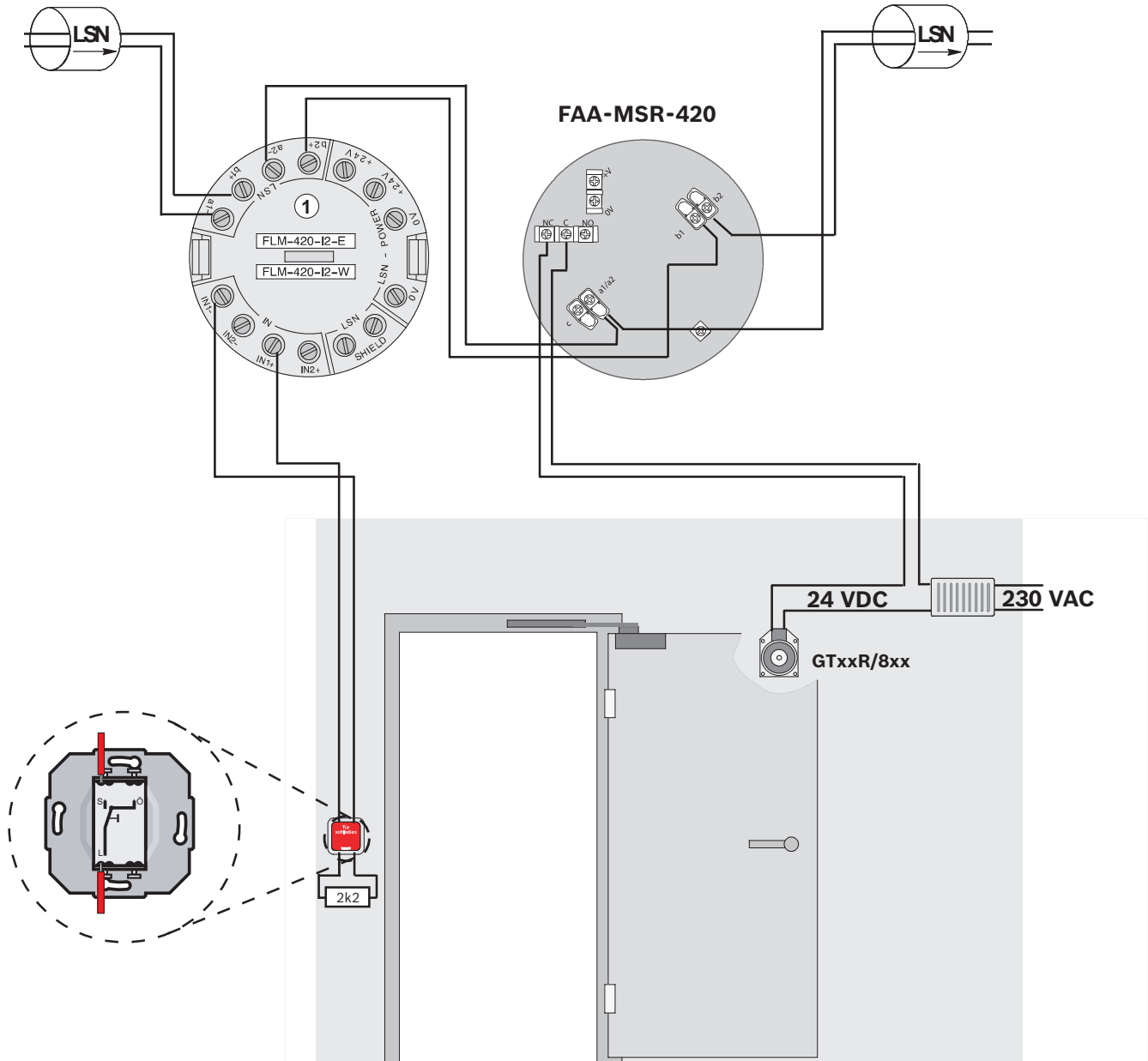

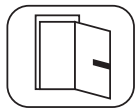

TS 73 EMF
 TS 93 EMF
 TS 93 GSR
 BTS 80 EMB
 BTS 80 FLB

DIBT

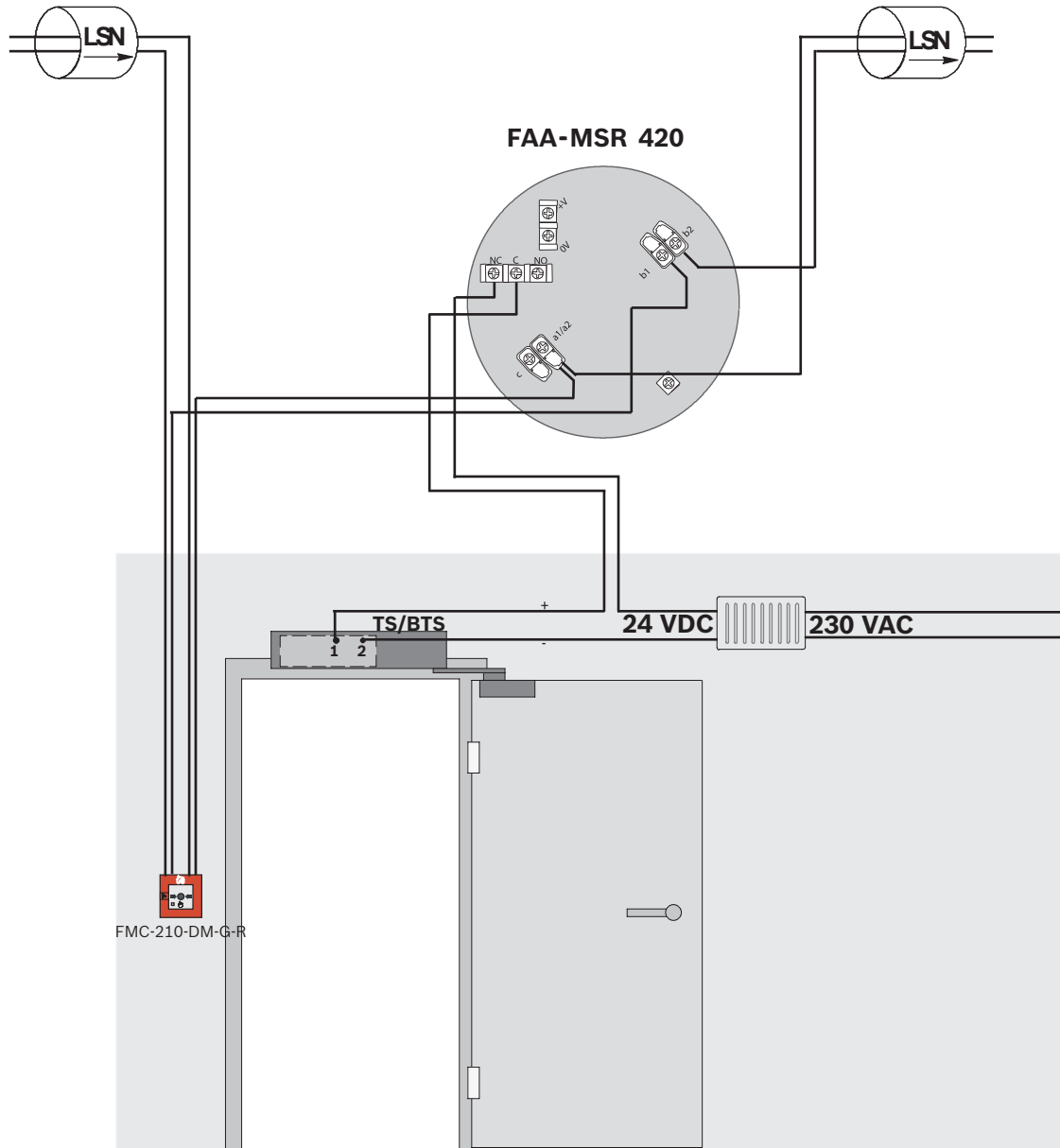

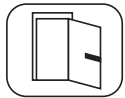

TS 73 EMF
 TS 93 EMF
 TS 93 GSR
 BTS 80 EMB
 BTS 80 FLB

DIBT

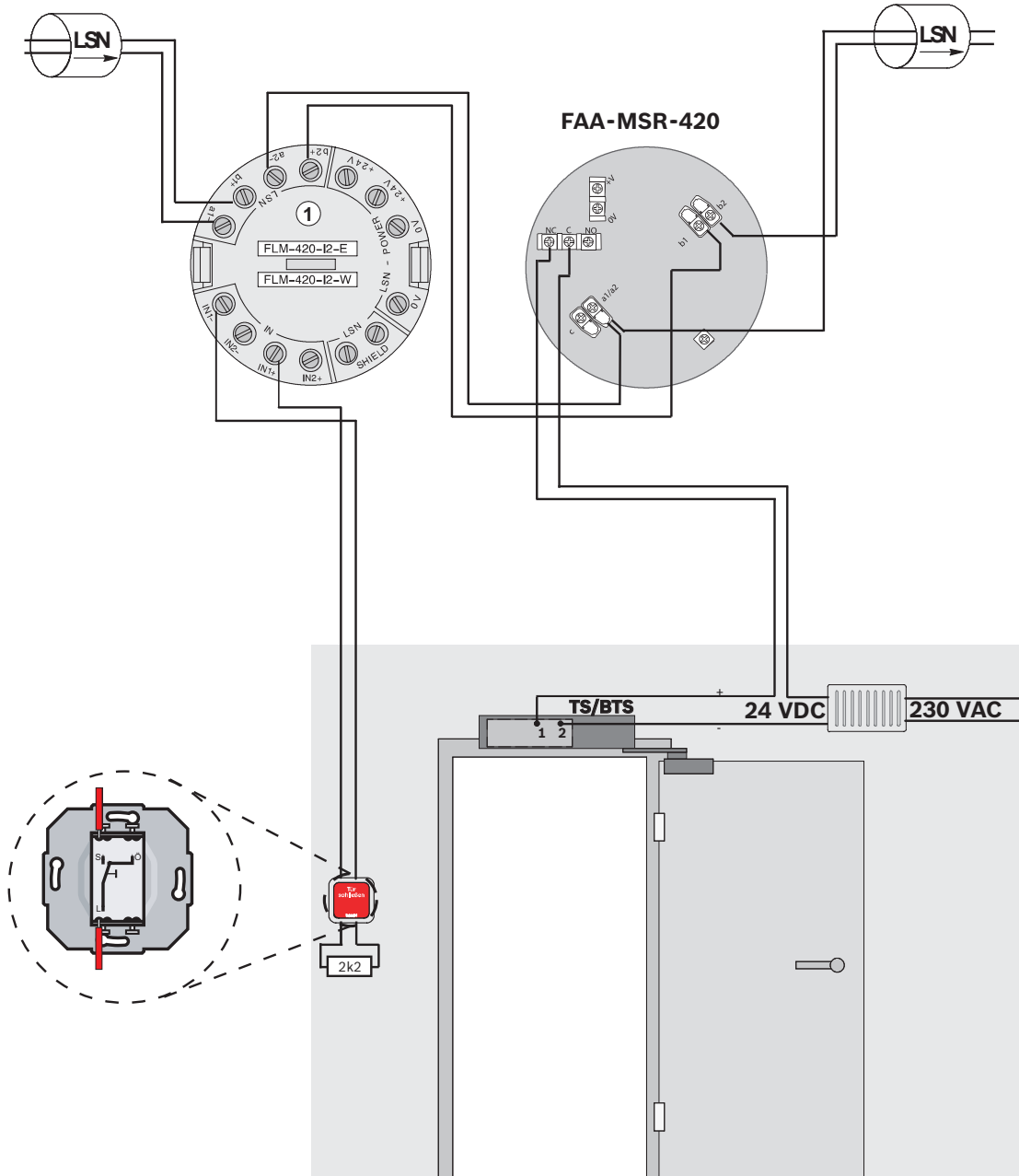

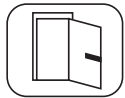

Slimdrive EMD-F/EMD F-IS

DIBT

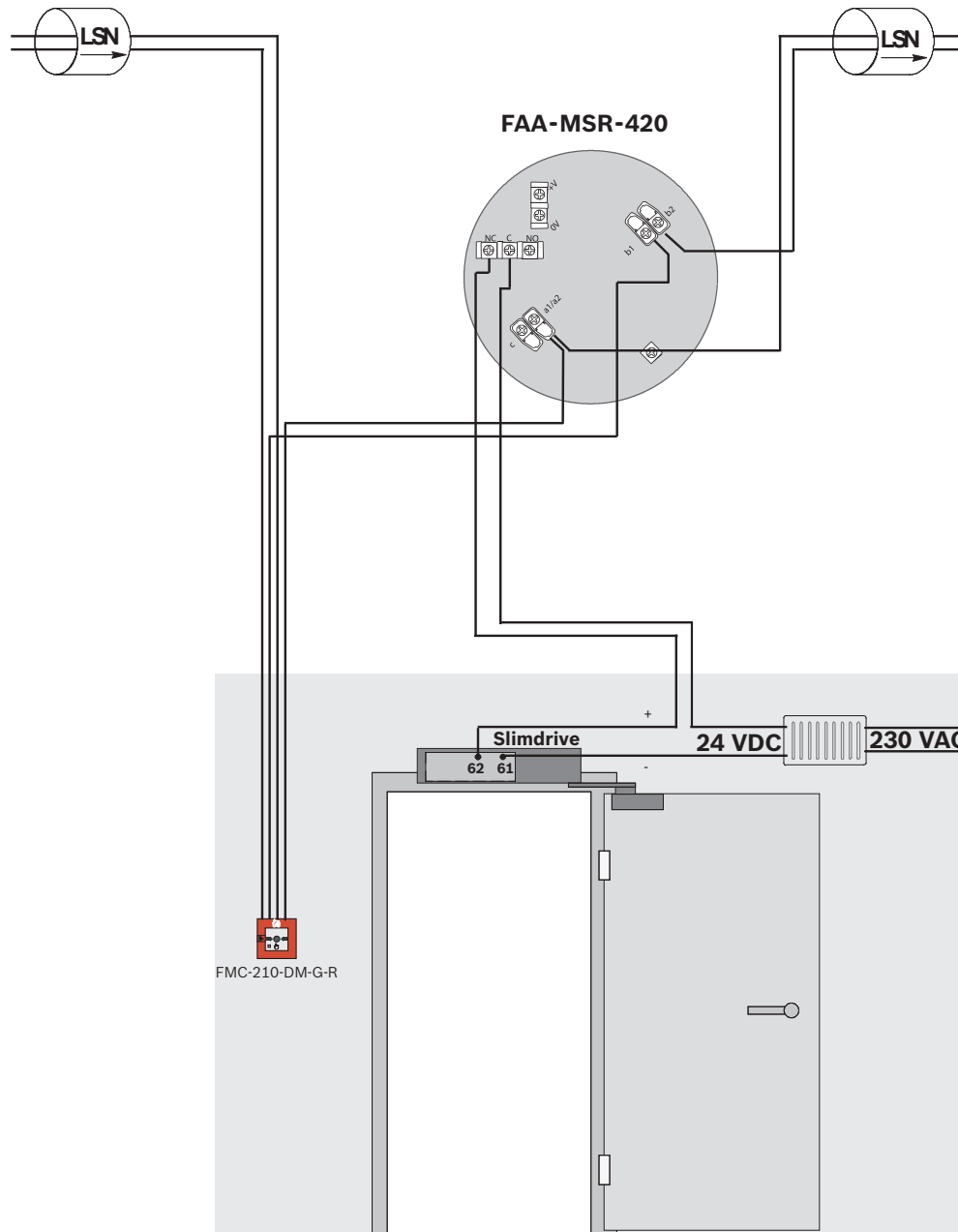

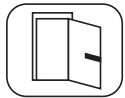

Slimdrive EMD-F/EMD F-IS

DIBT

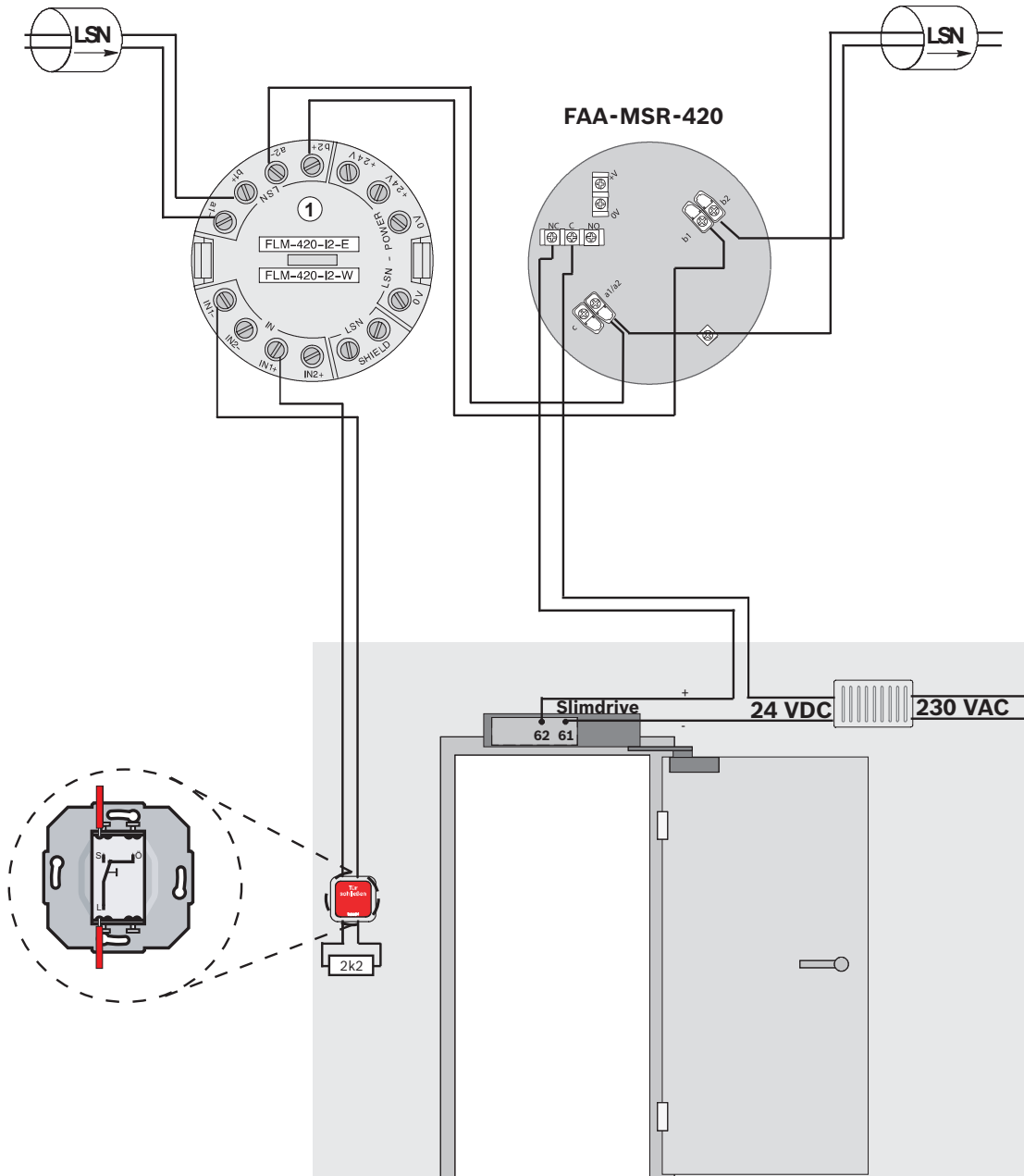

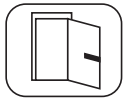

TS 4000 E/E-IS/EFS
 TS 5000 E/E-IS/E-ISM
 TS 550 E
 TSA 160 NT F/F-IS/F-IS/TS

DIBT

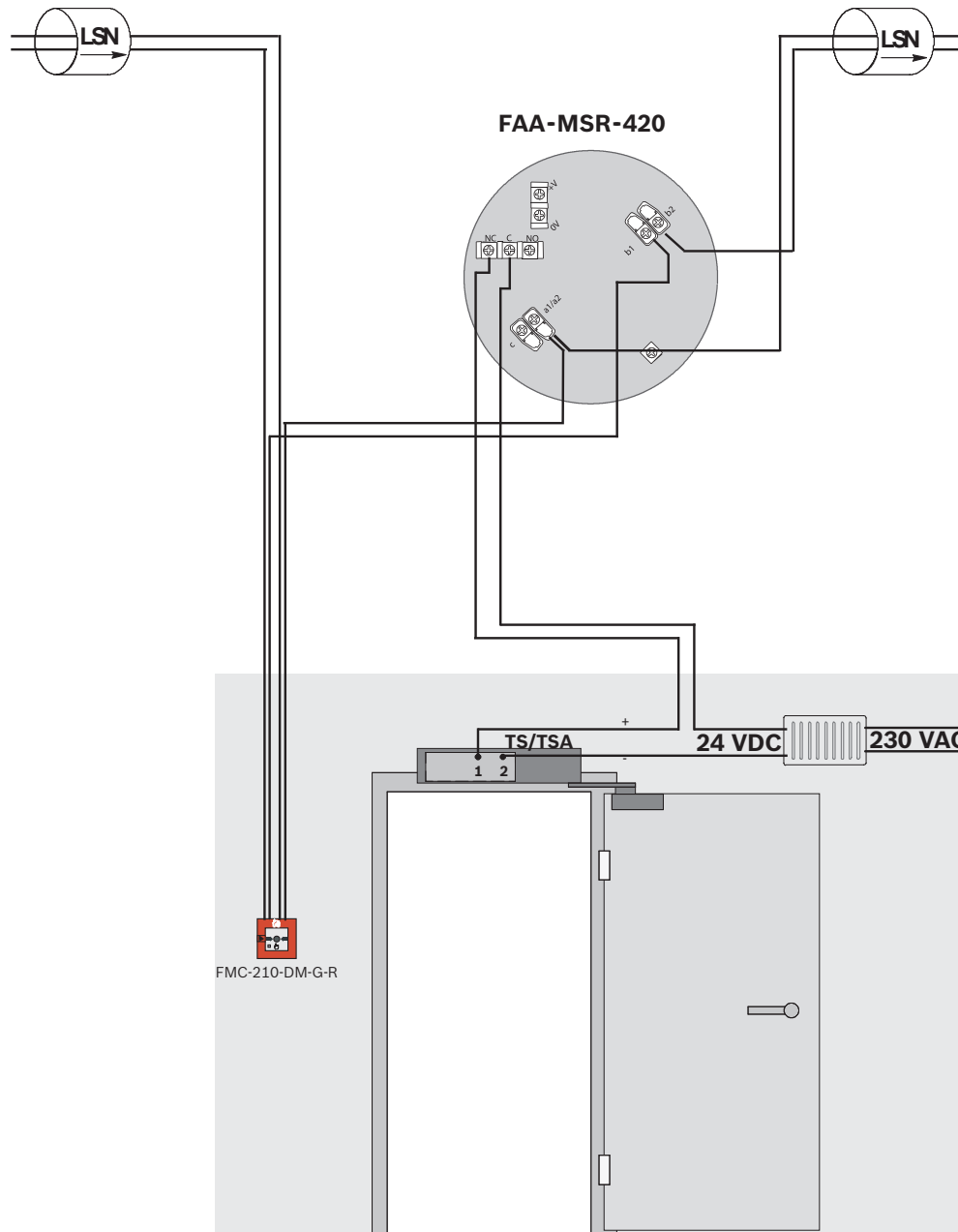

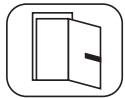

TS 4000 E/E-IS/EFS
 TS 5000 E/E-IS/E-ISM
 TS 550 E
 TSA 160 NT F/F-IS/F-IS/TS

DIBT

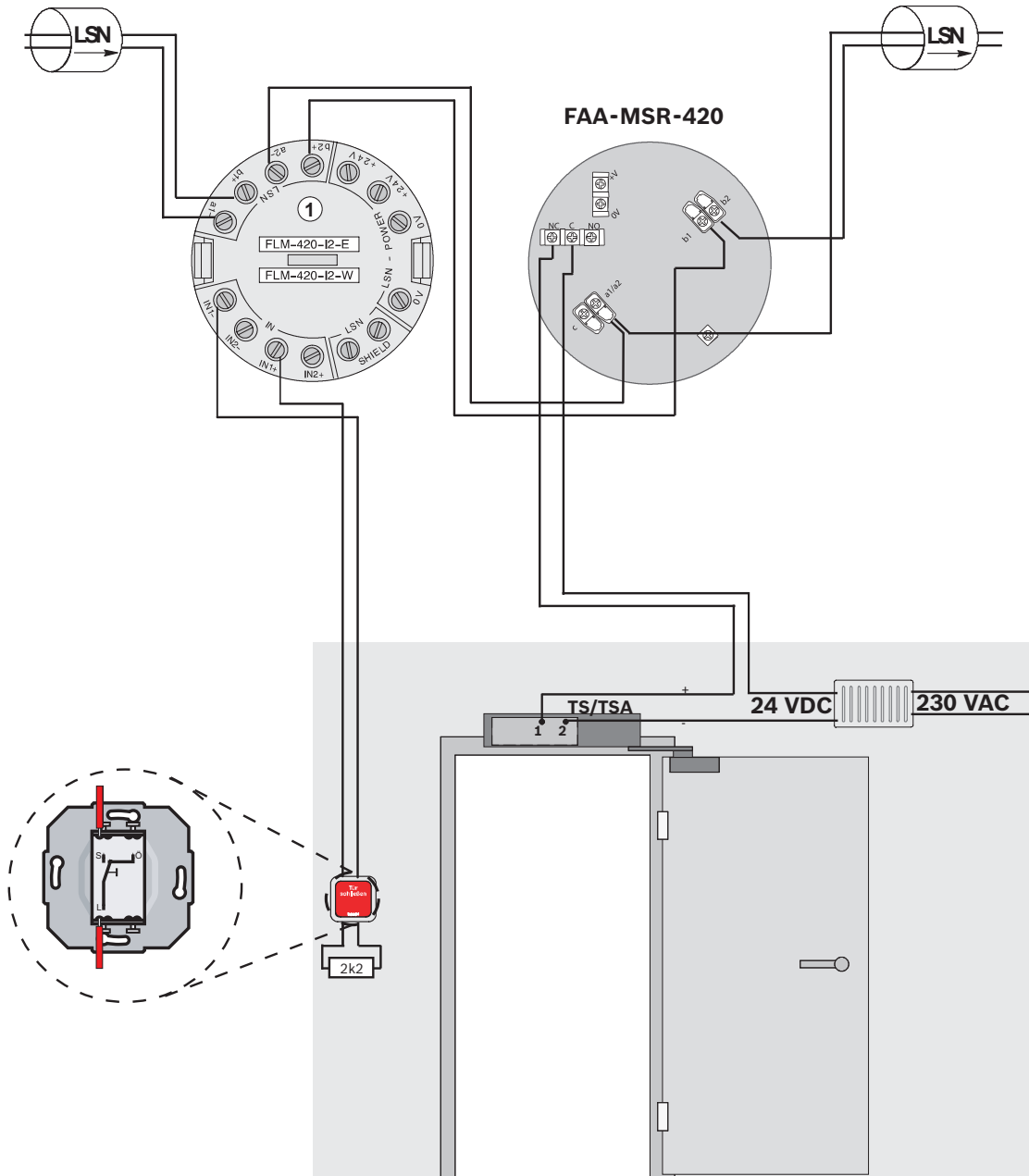

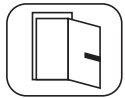

**ED 100
ED 250
(+Upgrade Card B**

DIBT

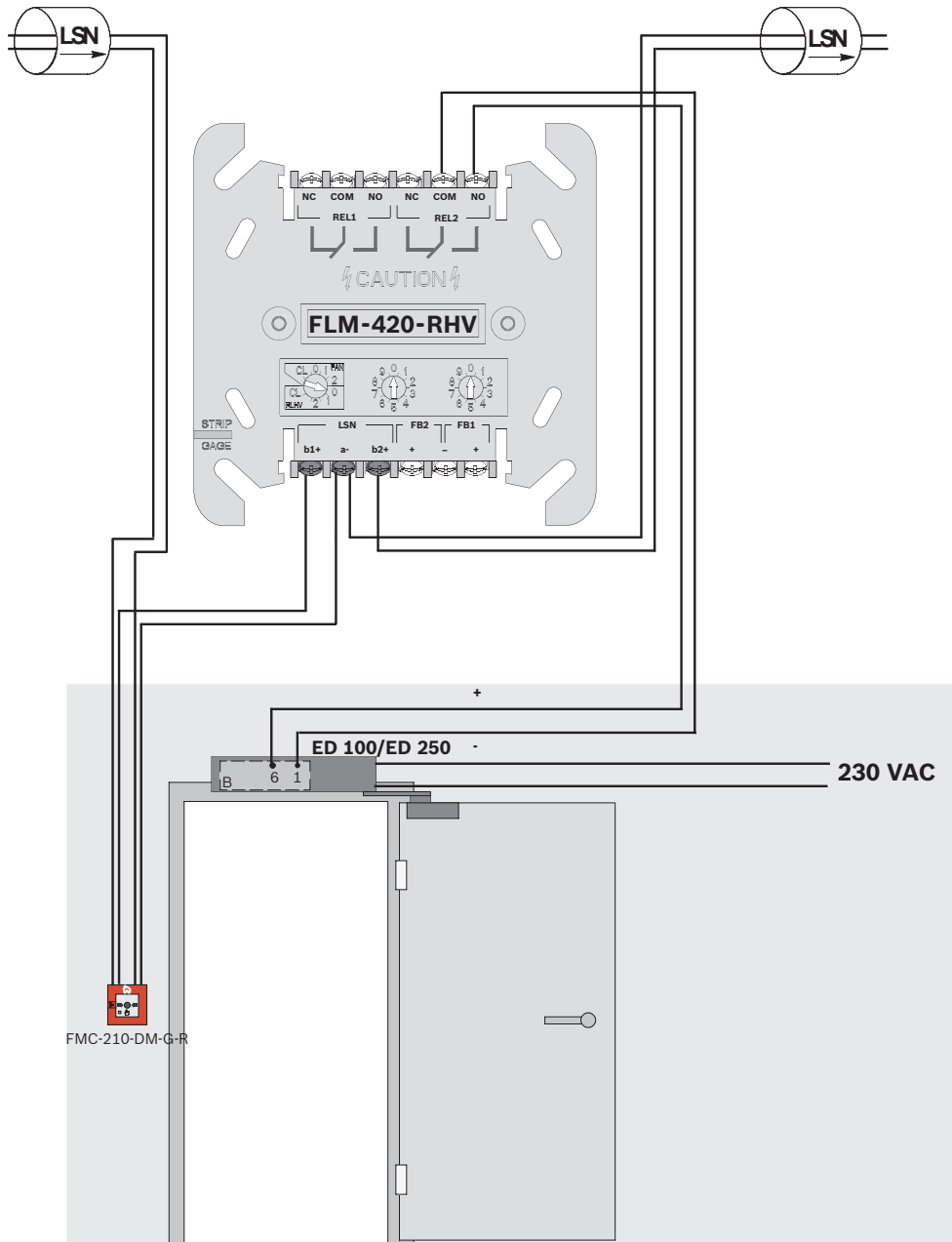

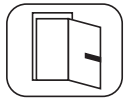

**ED 100
ED 250
(+Upgrade Card B)**

DIBT

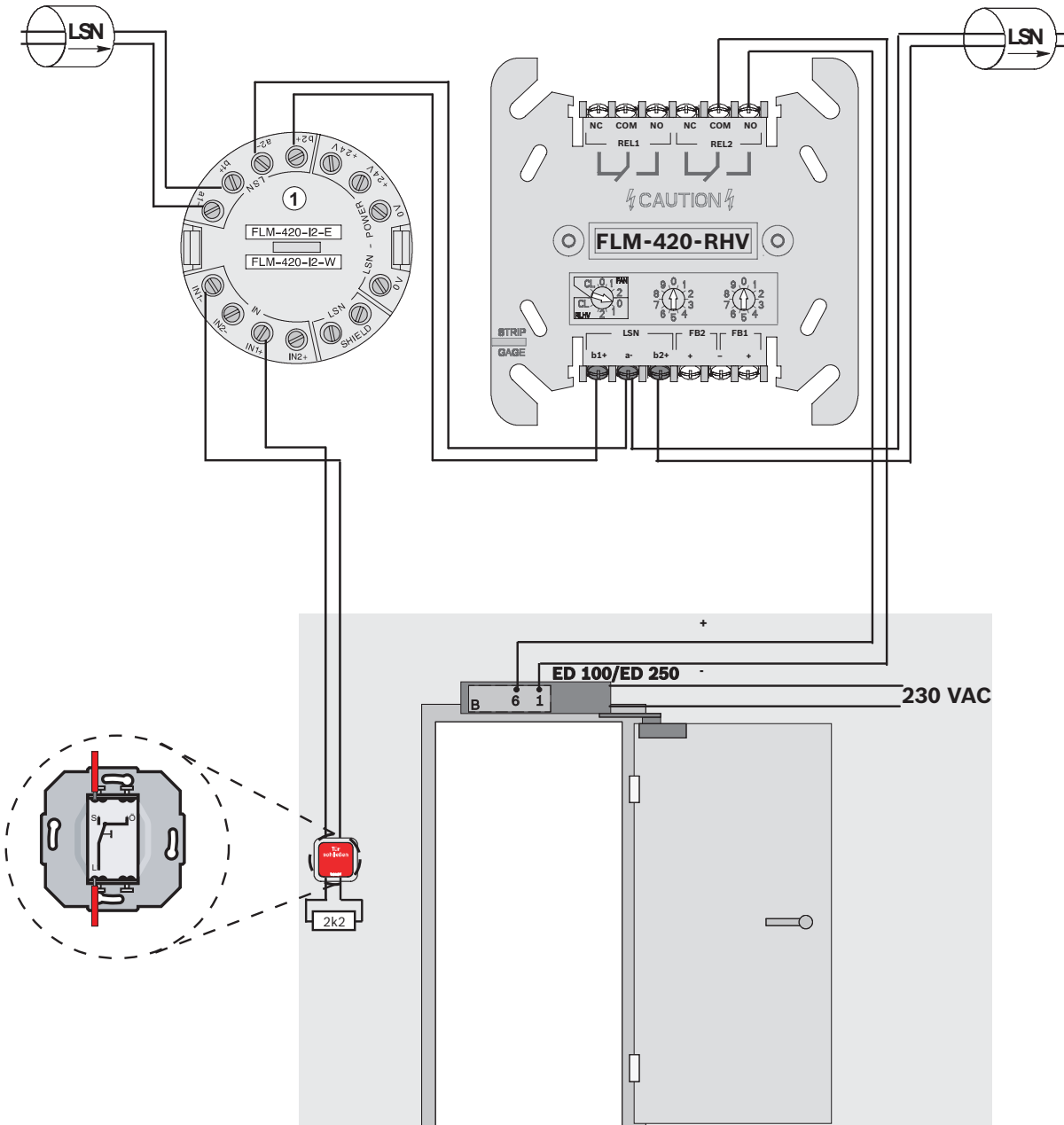

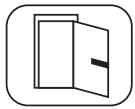

DIBT

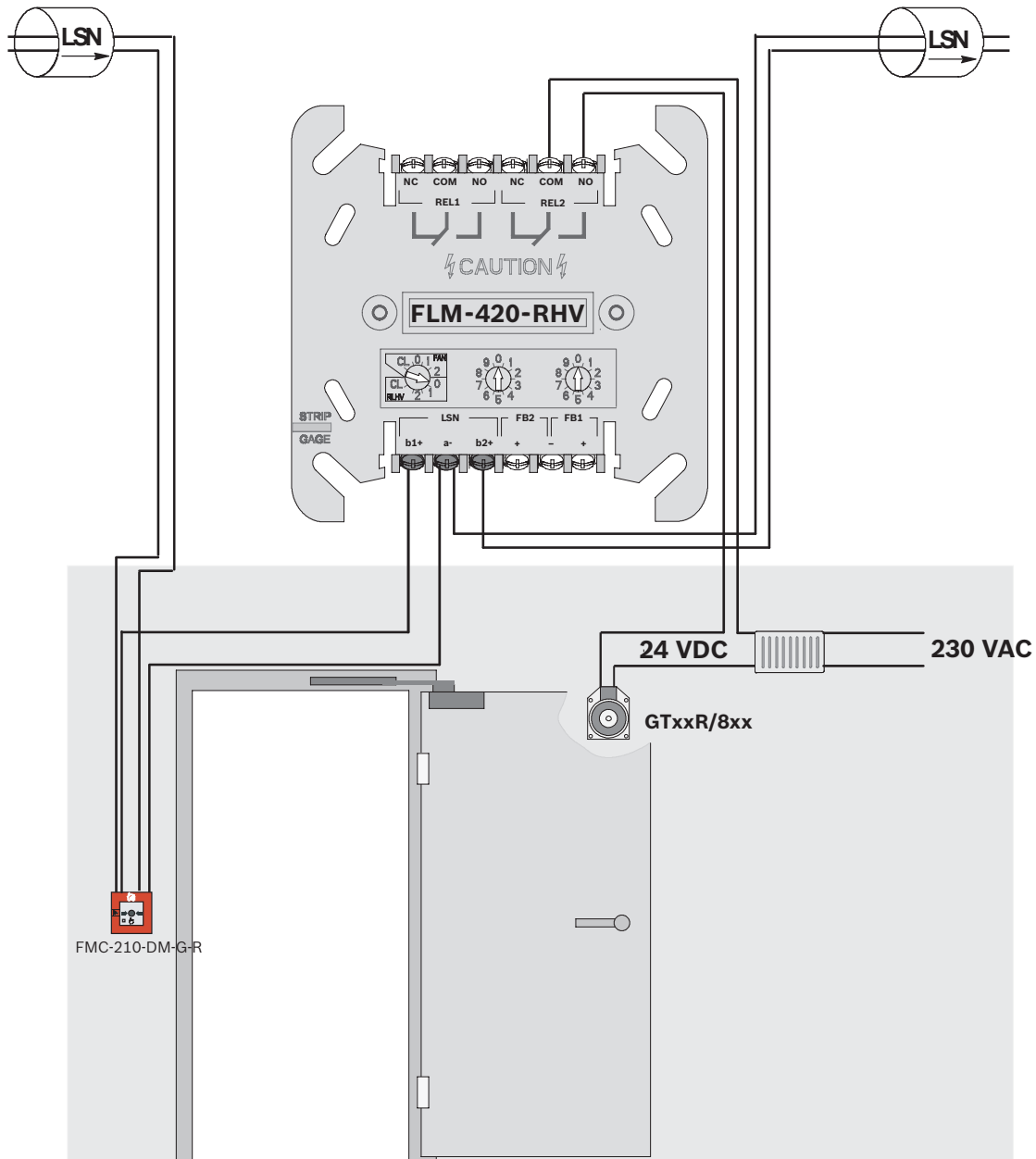

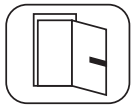

DIBT

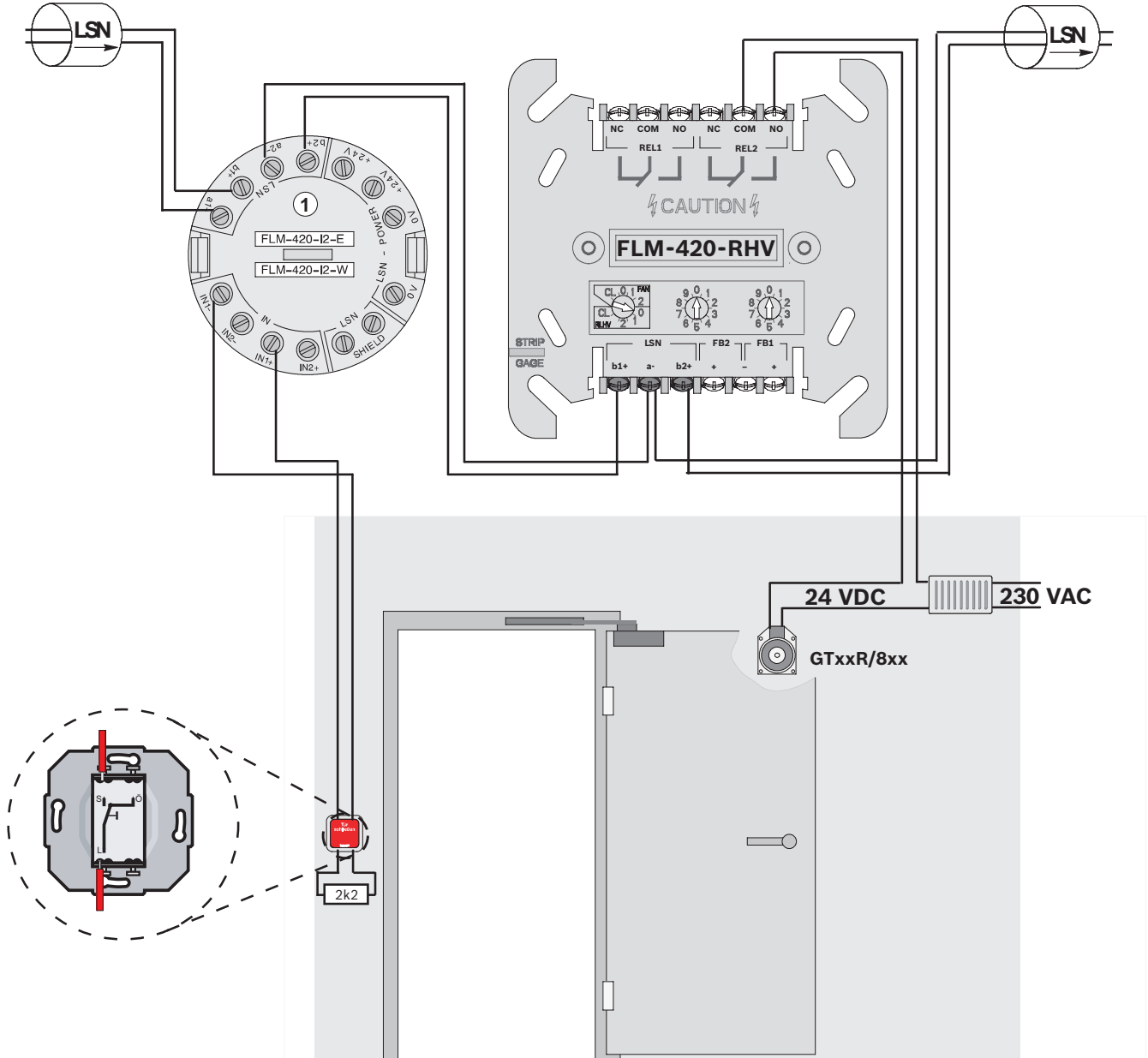

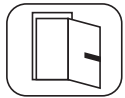

TS 73 EMF
 TS 93 EMF
 TS 93 GSR
 BTS 80 EMB
 BTS 80 FLB

DIBT

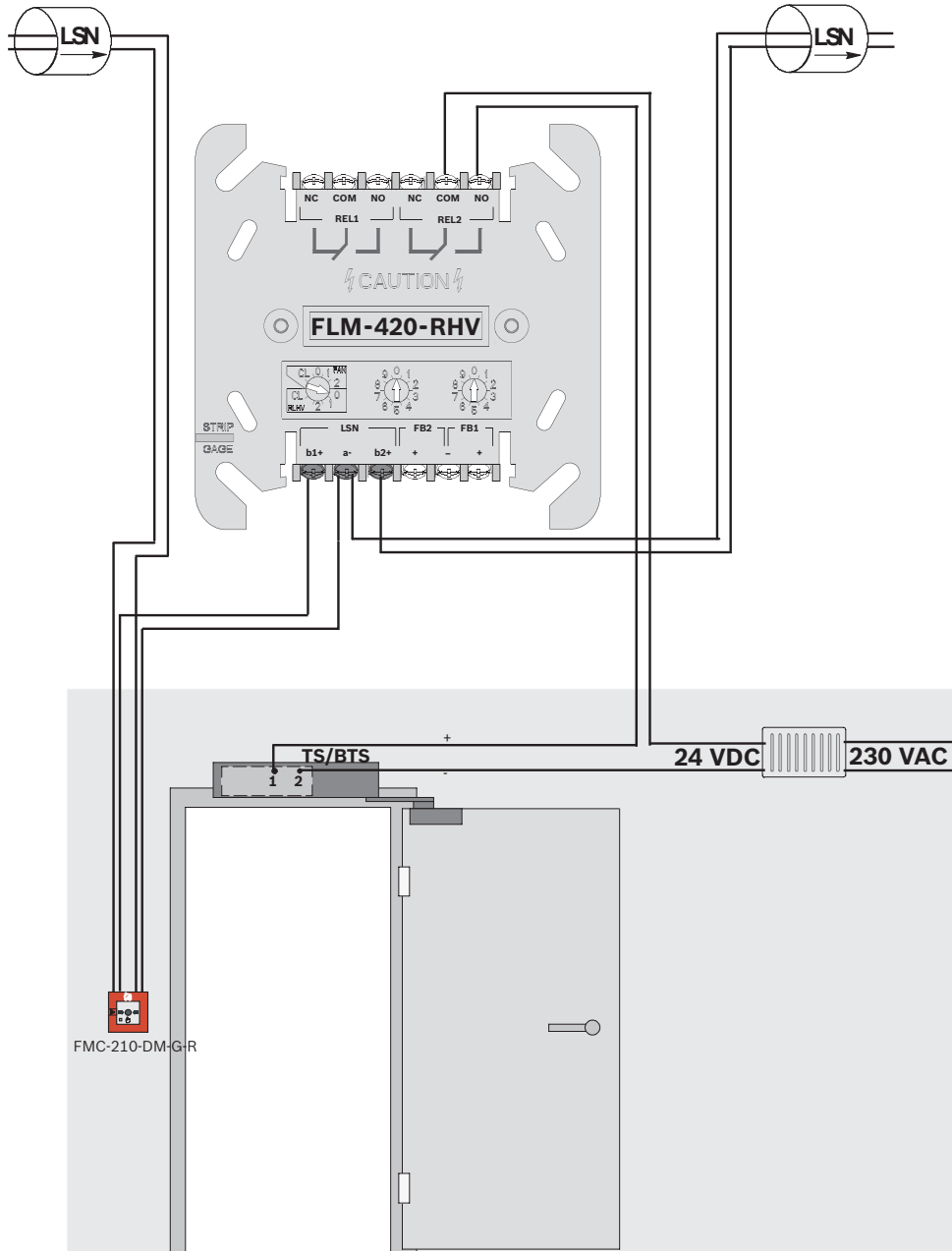

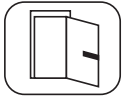

TS 73 EMF
 TS 93 EMF
 TS 93 GSR
 BTS 80 EMB
 BTS 80 FLB

DIBT

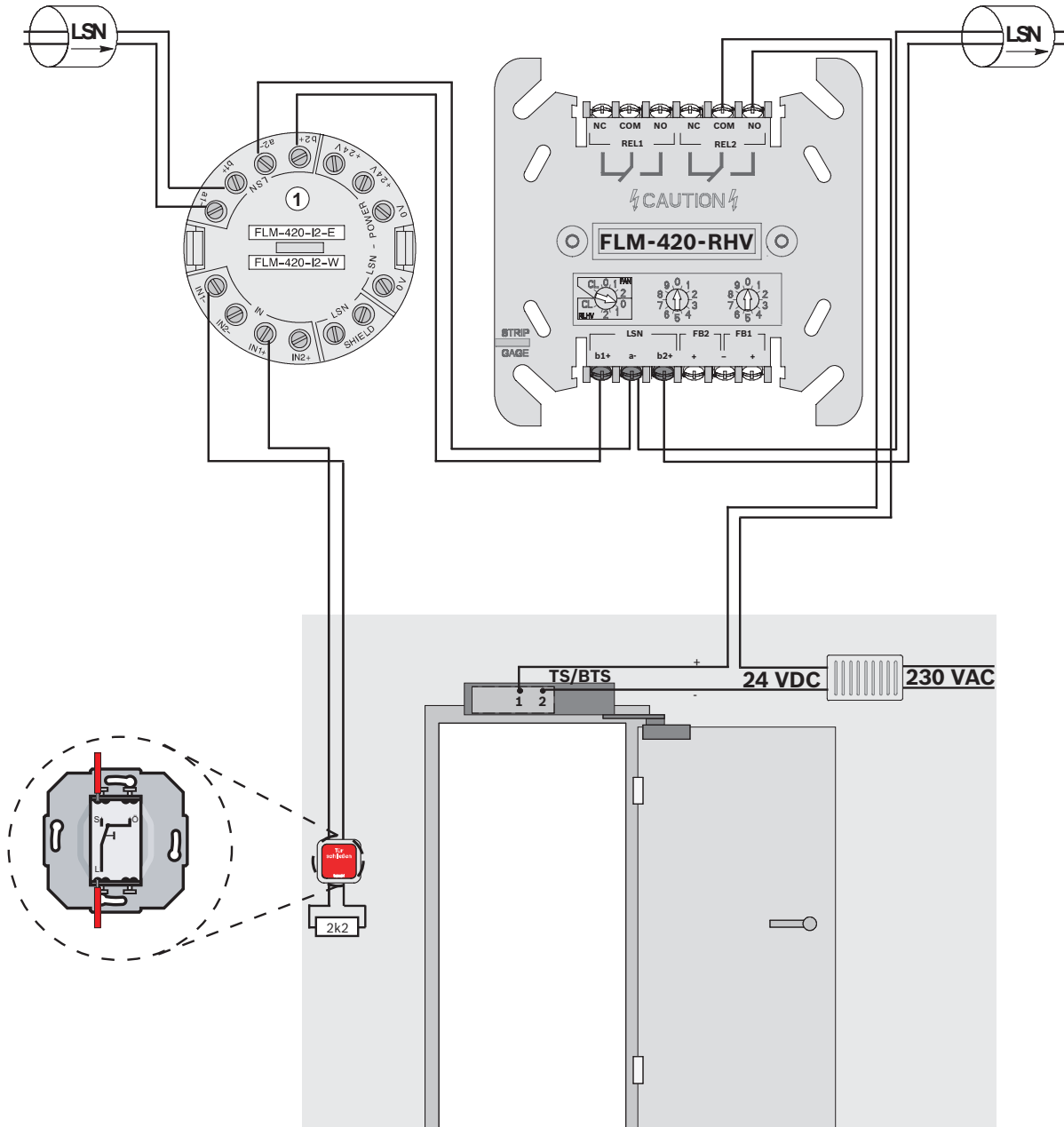



Slimdrive EMD-F/EMD F-IS

DIBT

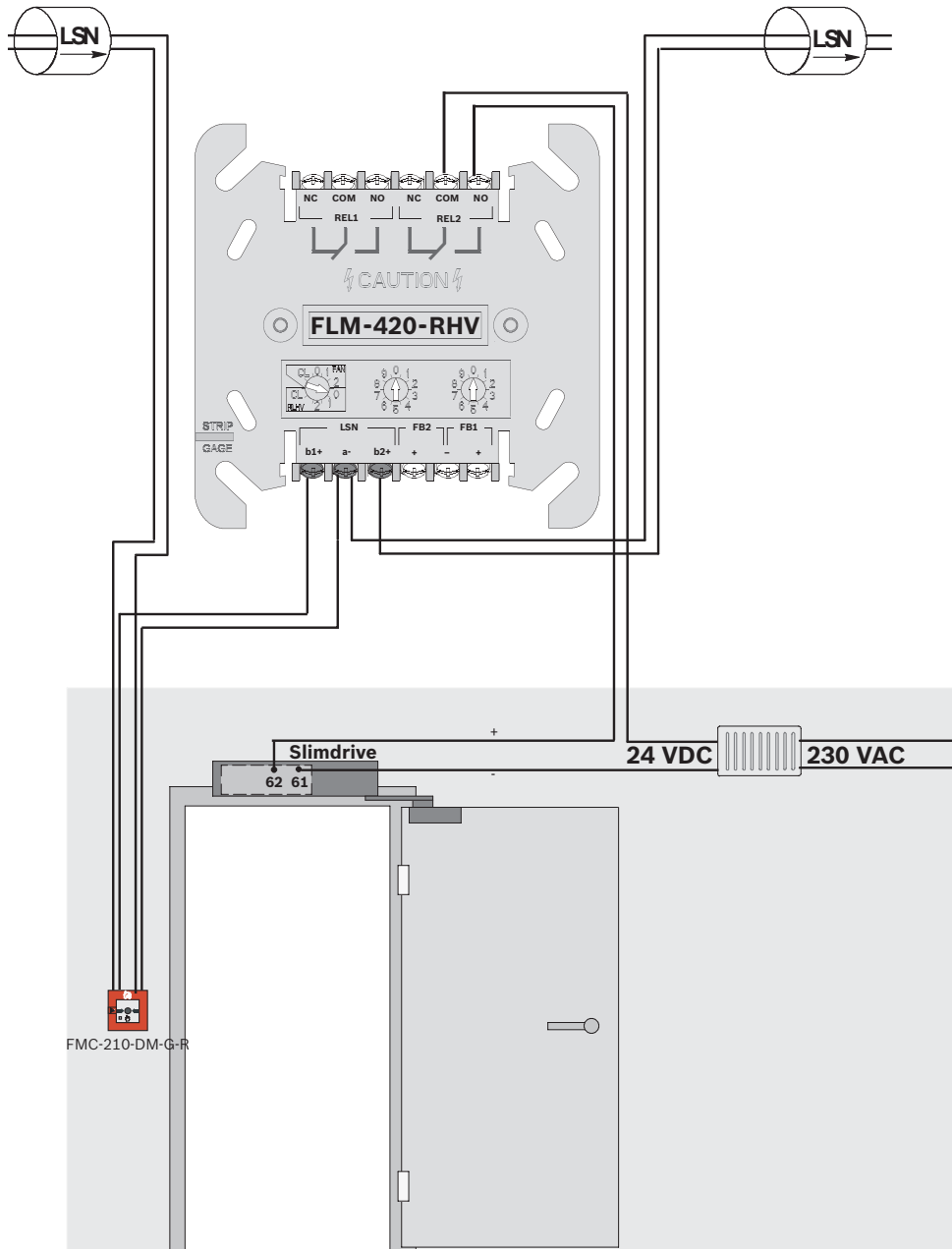



Slimdrive EMD-F/EMD F-IS

DIBT

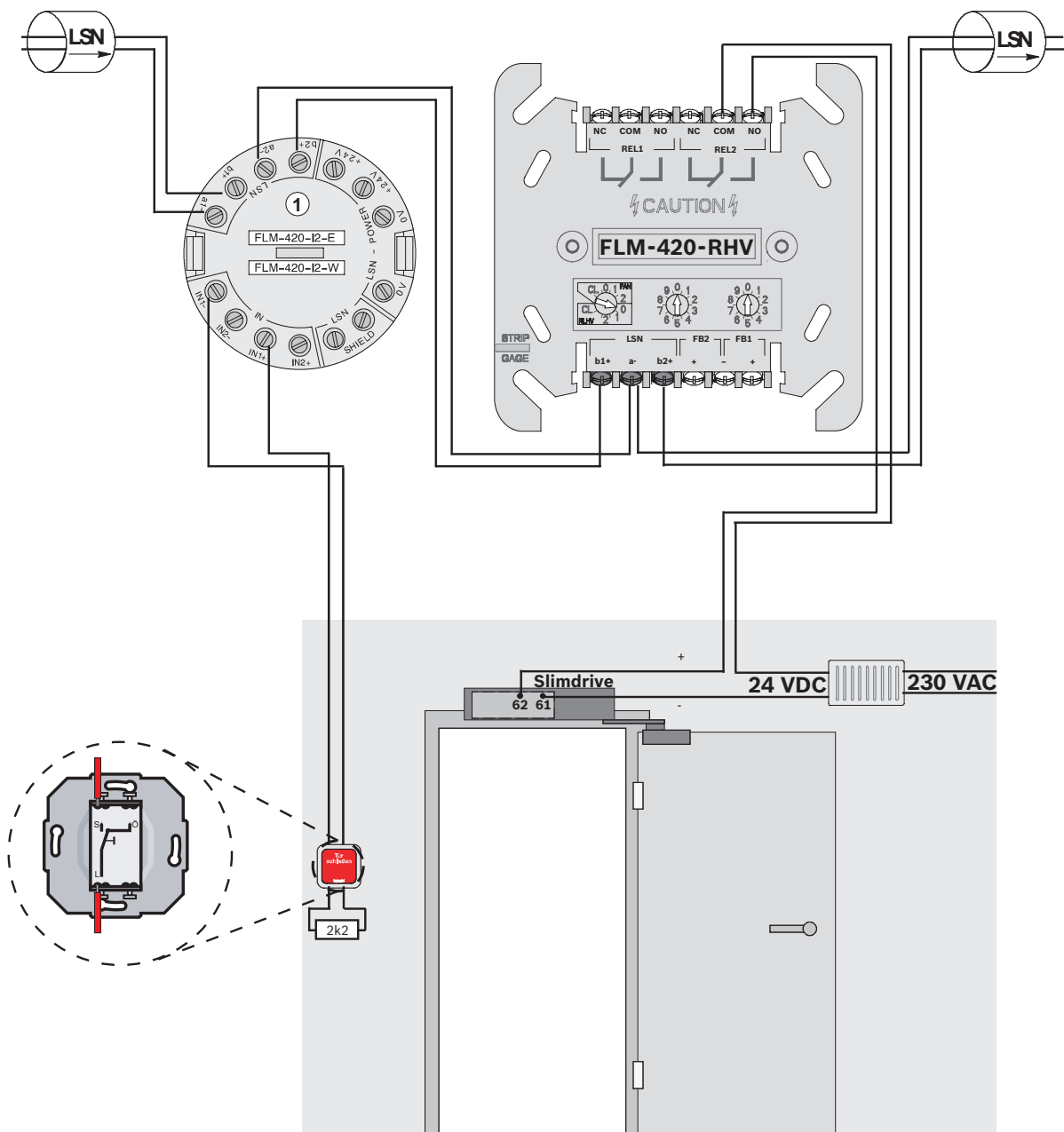



TS 4000 E/E-IS/EFS
 TS 5000 E/E-IS/E-ISM
 TS 550 E
 TSA 160 NT F/F-IS/F-IS/TS

DIBT

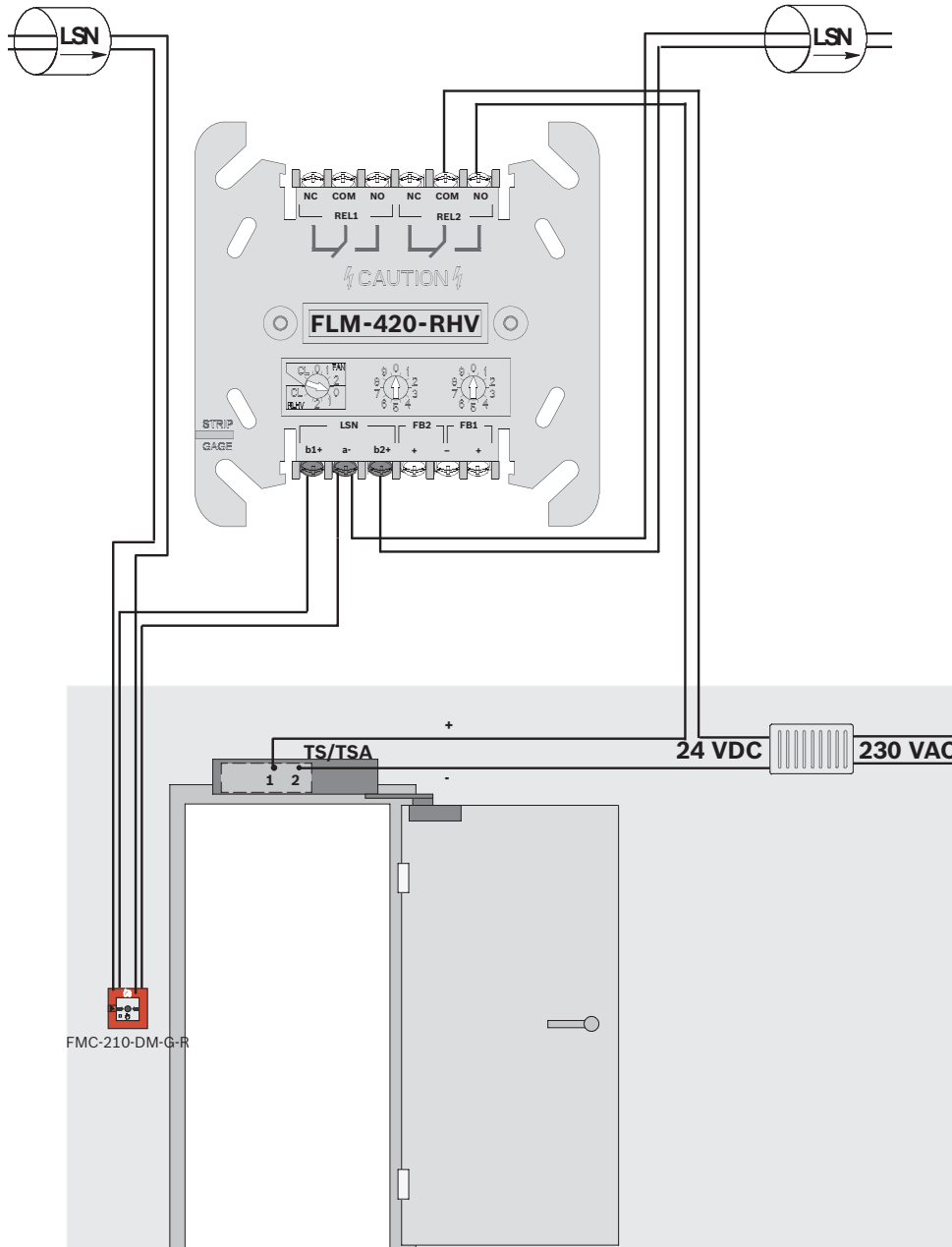

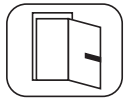

TS 4000 E/E-IS/EFS
TS 5000 E/E-IS/E-ISM
TS 550 E
TSA 160 NT F/F-IS/F-IS/TS

DIBT

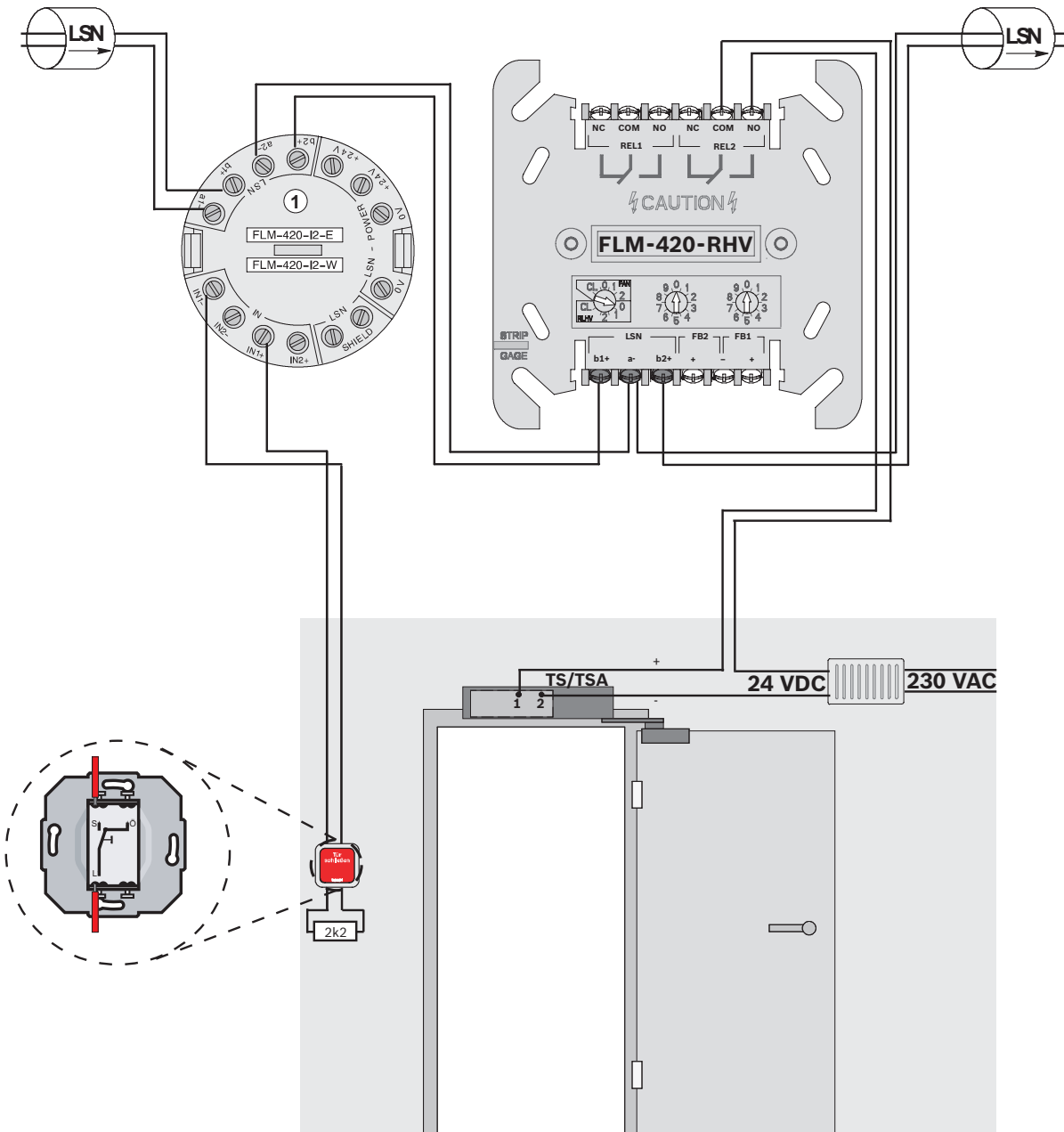

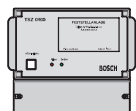

TSZ 0400

DIBT

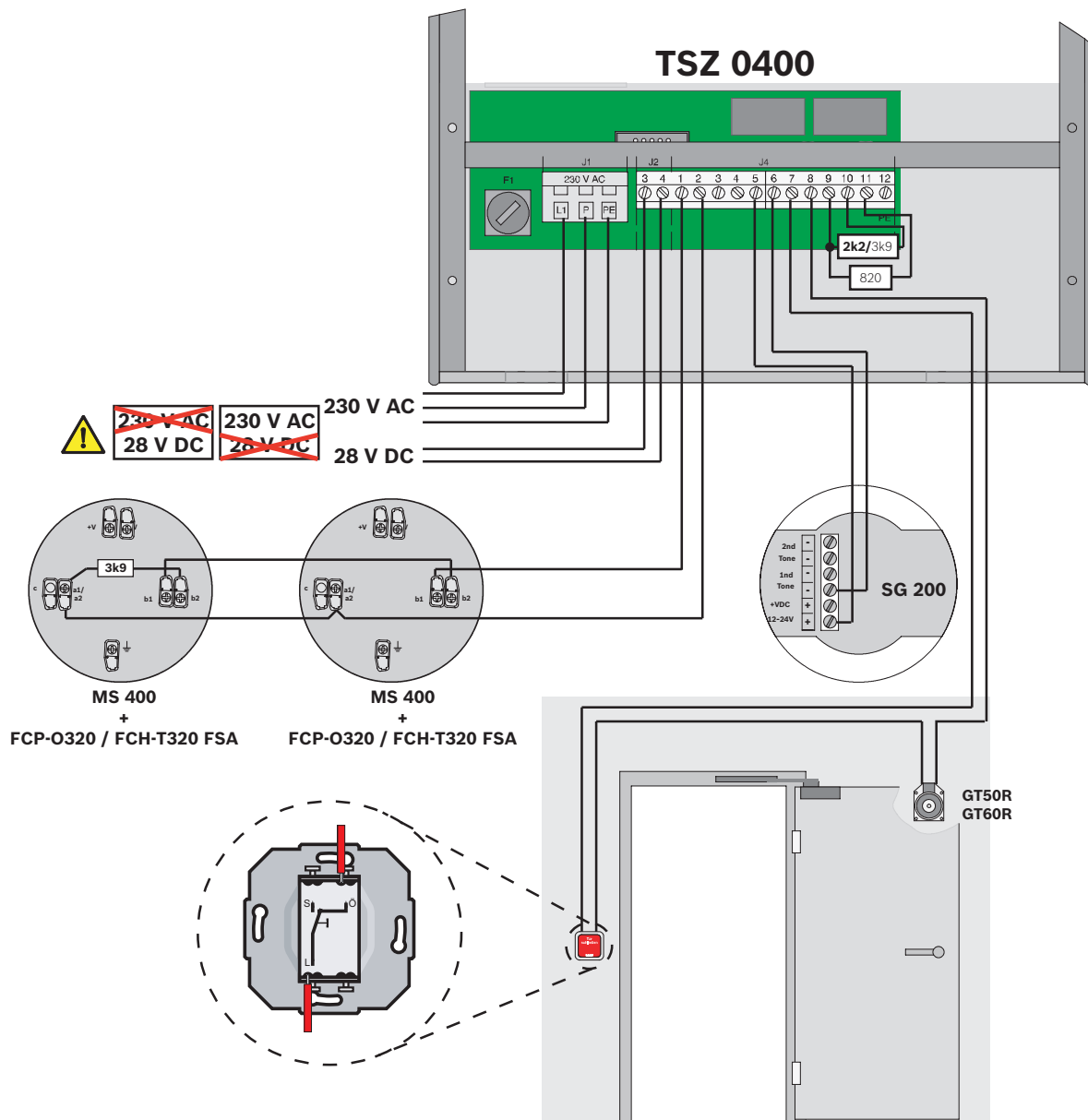

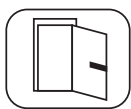

DIBT

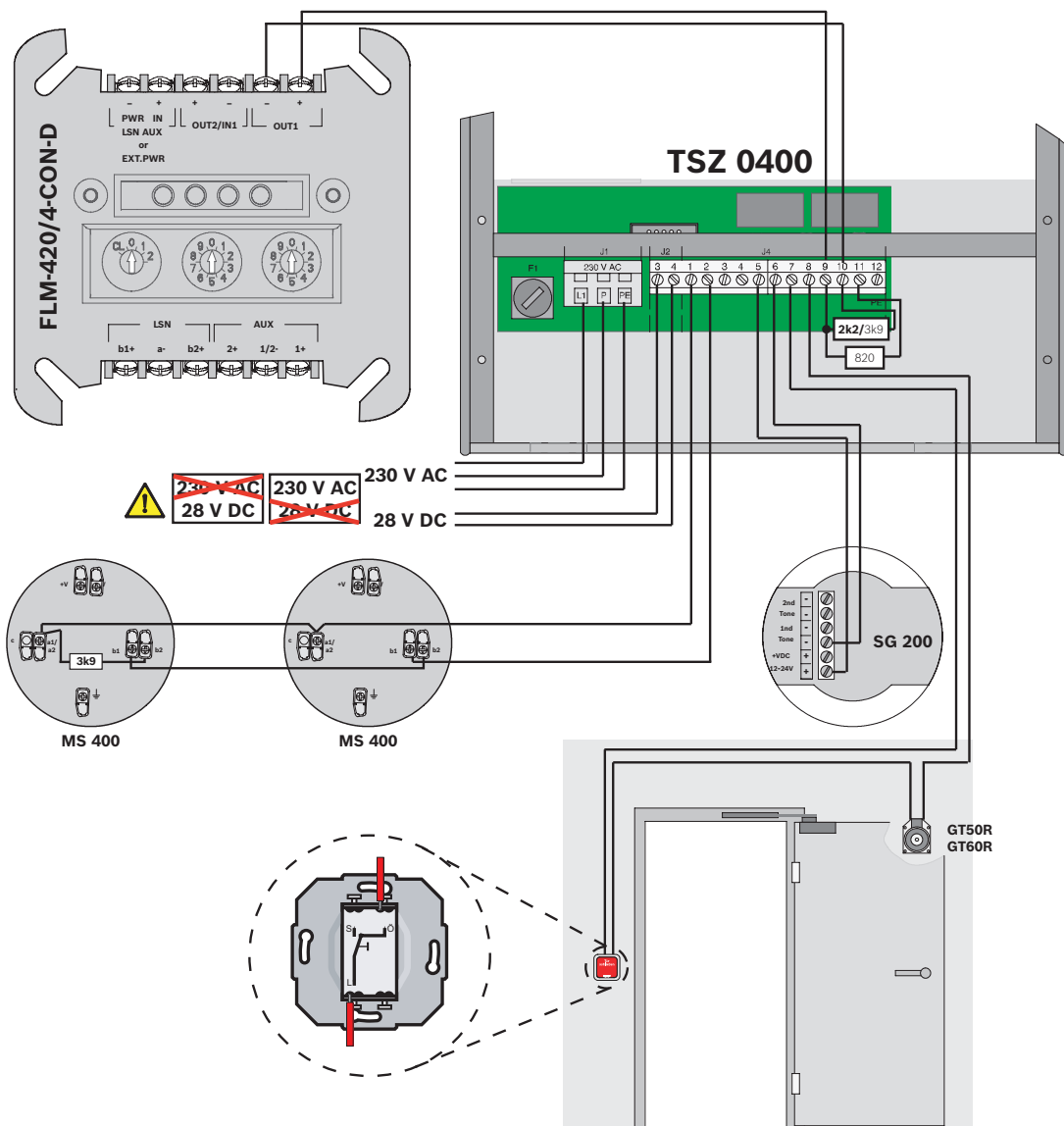

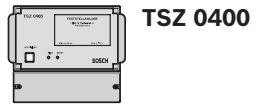

DIBT

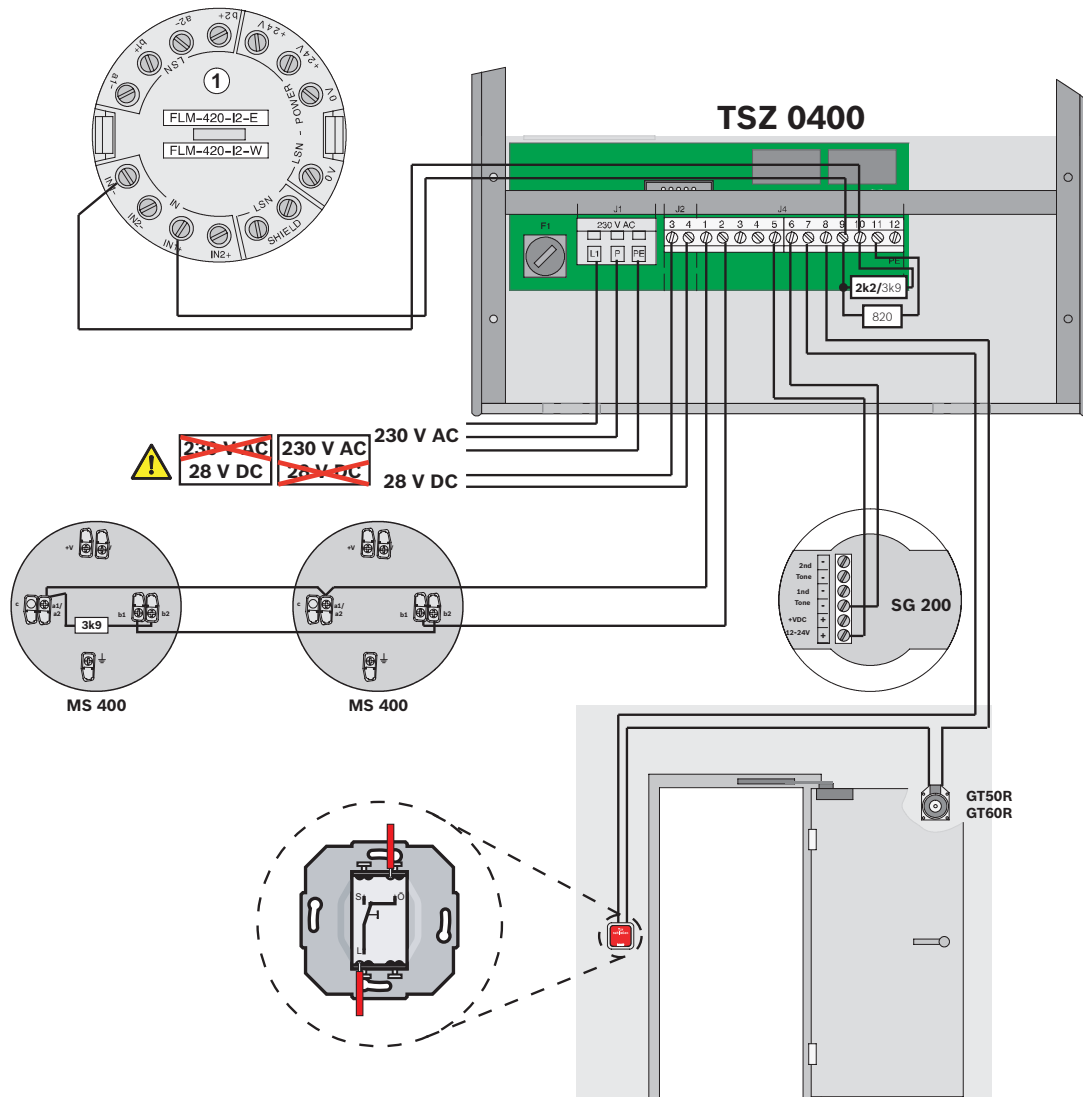

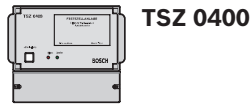
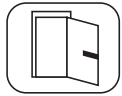

DIBT

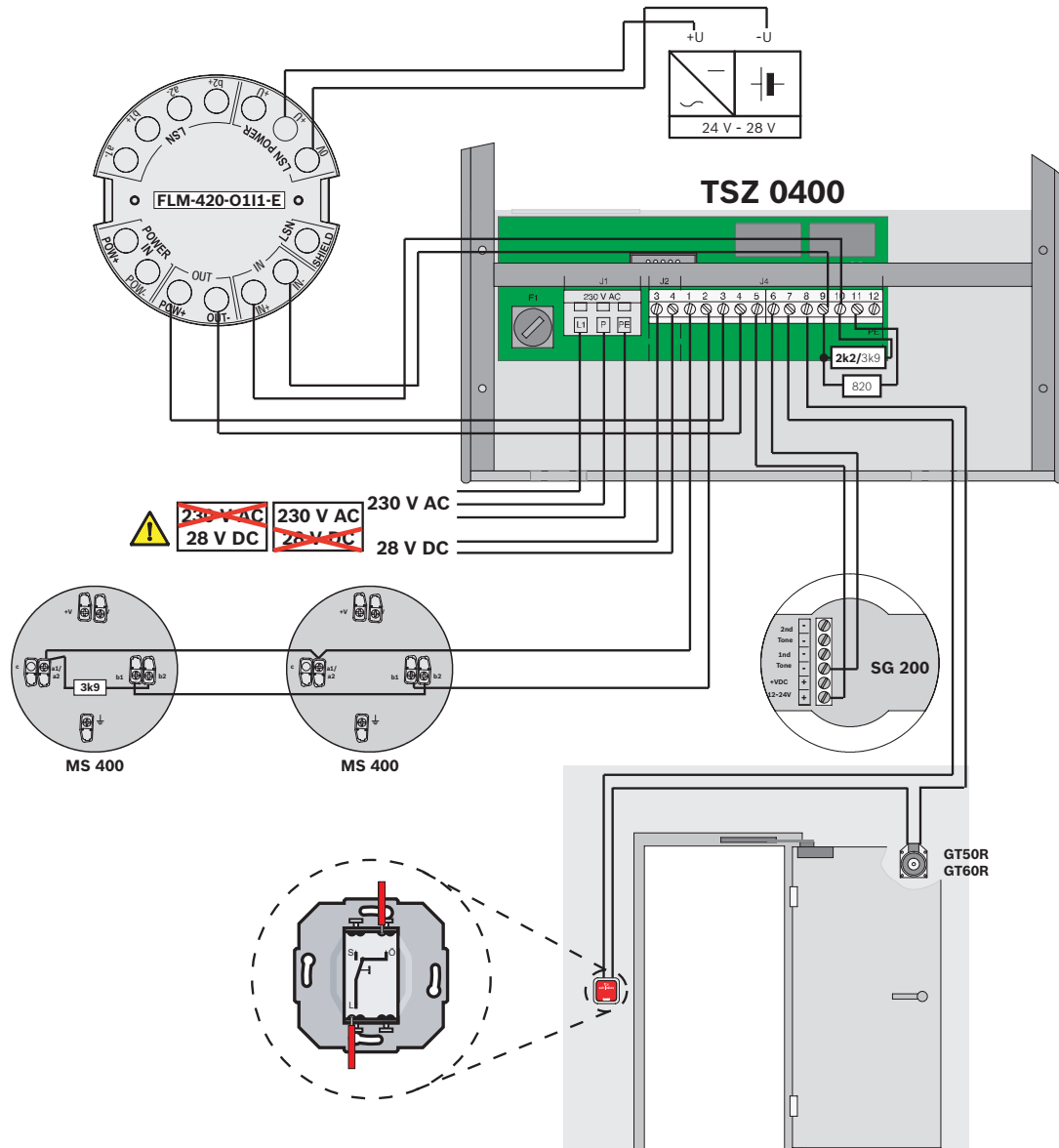

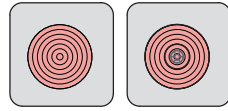

FAA-420-RI-ROW
FAA-420-RI-DIN

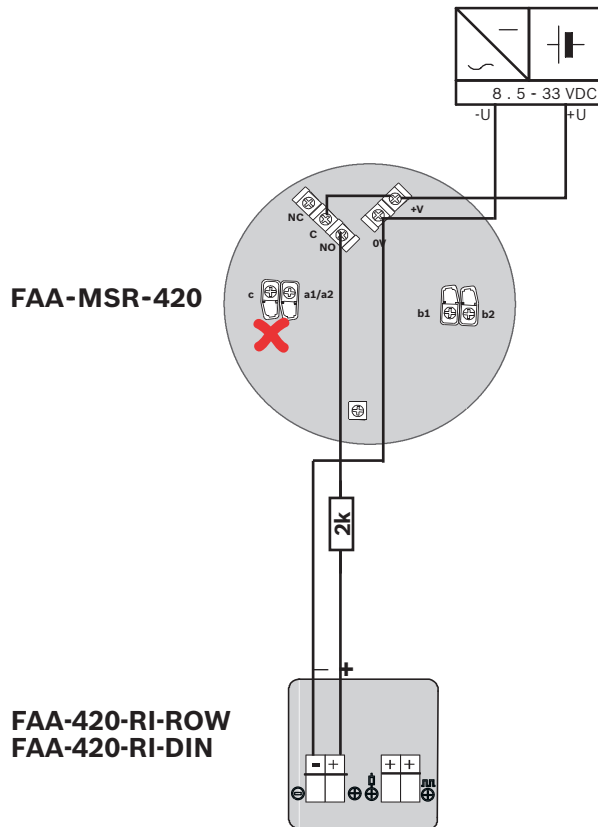
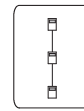

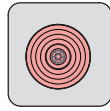

FAA-420-RI-DIN

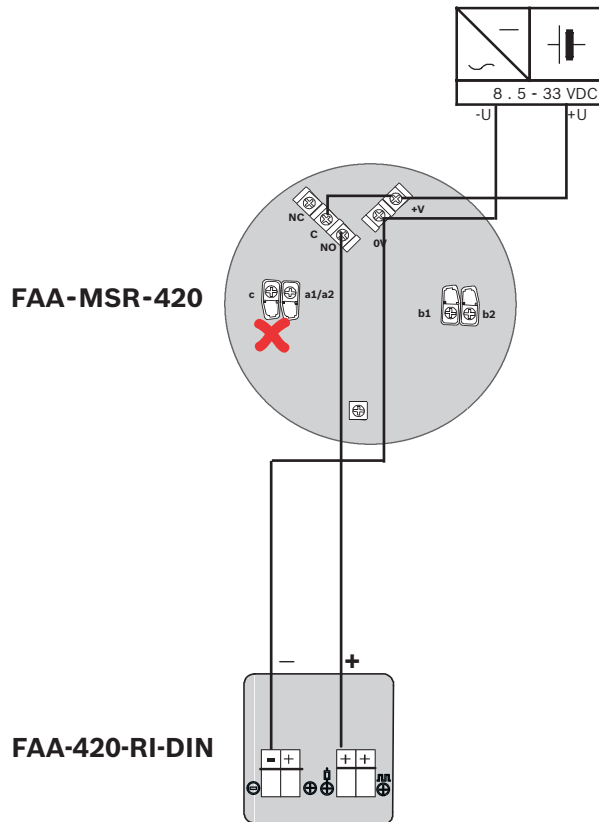
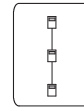

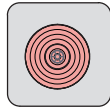

FAA-420-RI-DIN

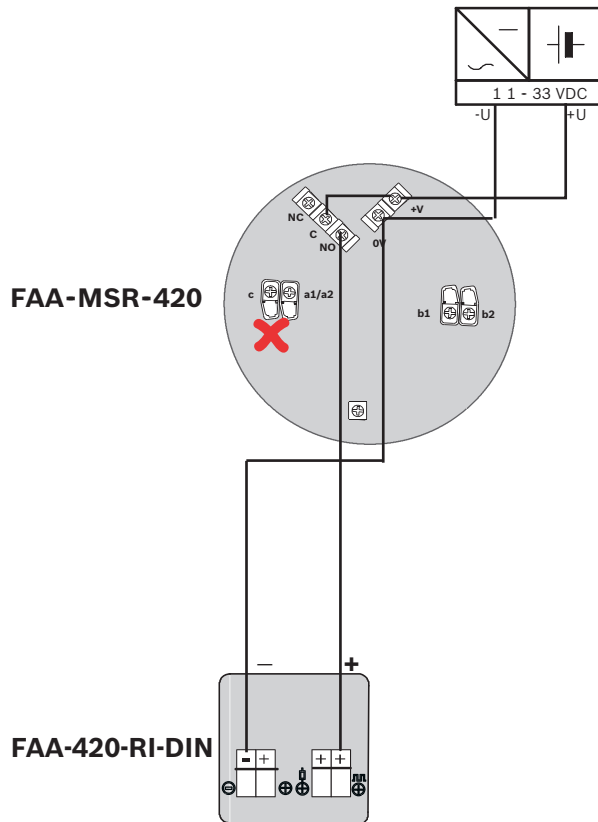
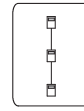

2.4

Functional Modules



BCM-000-B, stranica 43

CZM 0004 A, stranica 45

ENO 0000 A/B, stranica 61

LSN 0300 A, stranica 68

NZM 0002 A, stranica 106

RMH 0002 A, stranica 119

IOS 0020 A, stranica 120

FPE-5000-UGM, stranica 122

2.4.1

BCM-000-B

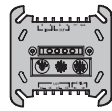
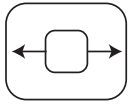

FLM-420-NAC-D

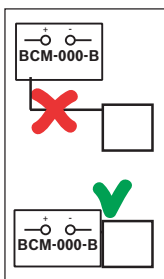
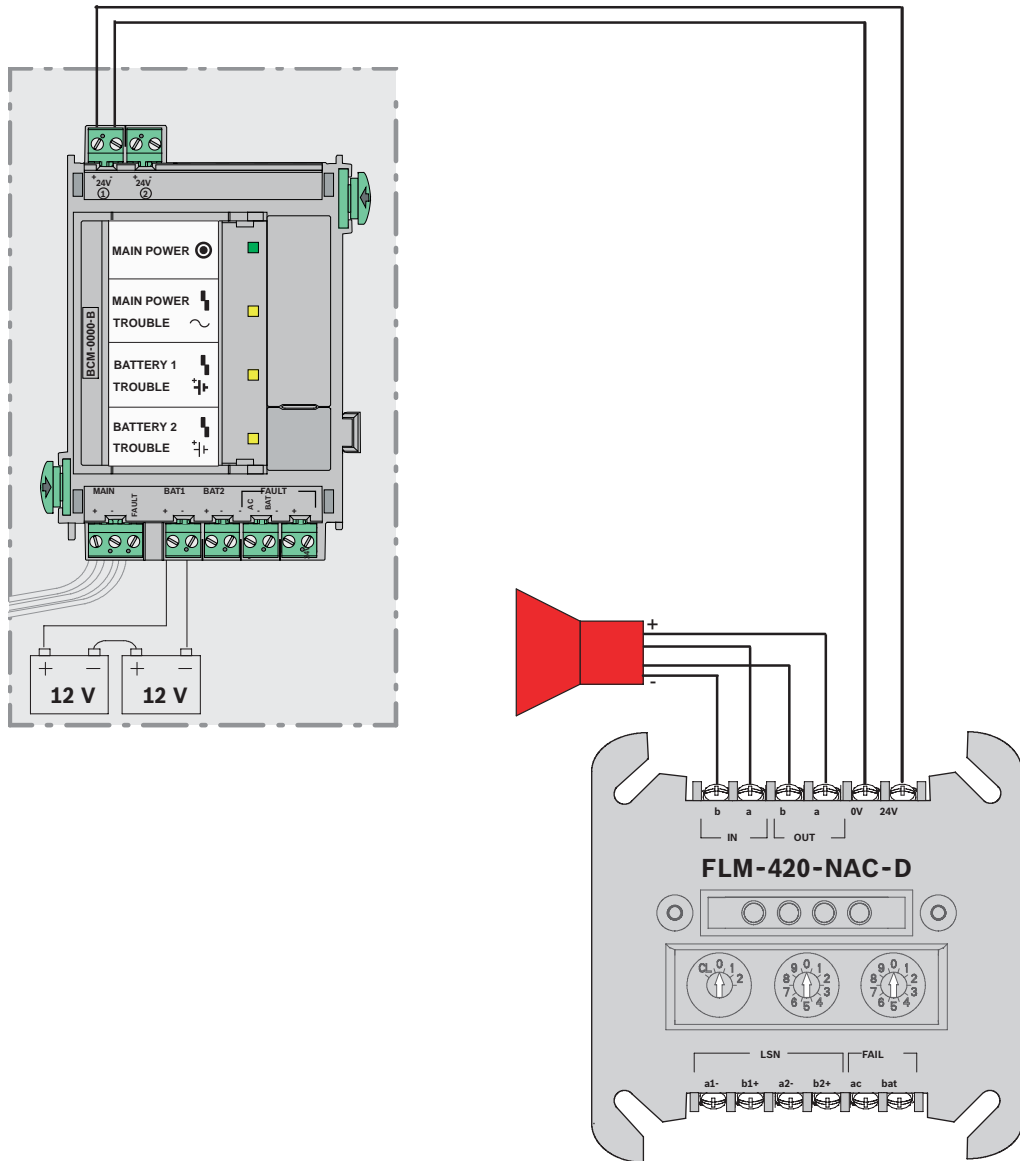
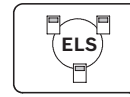

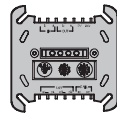
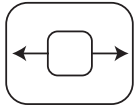

FLM-420-NAC-D

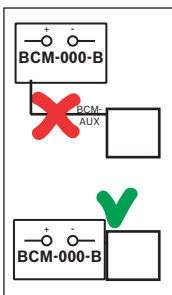
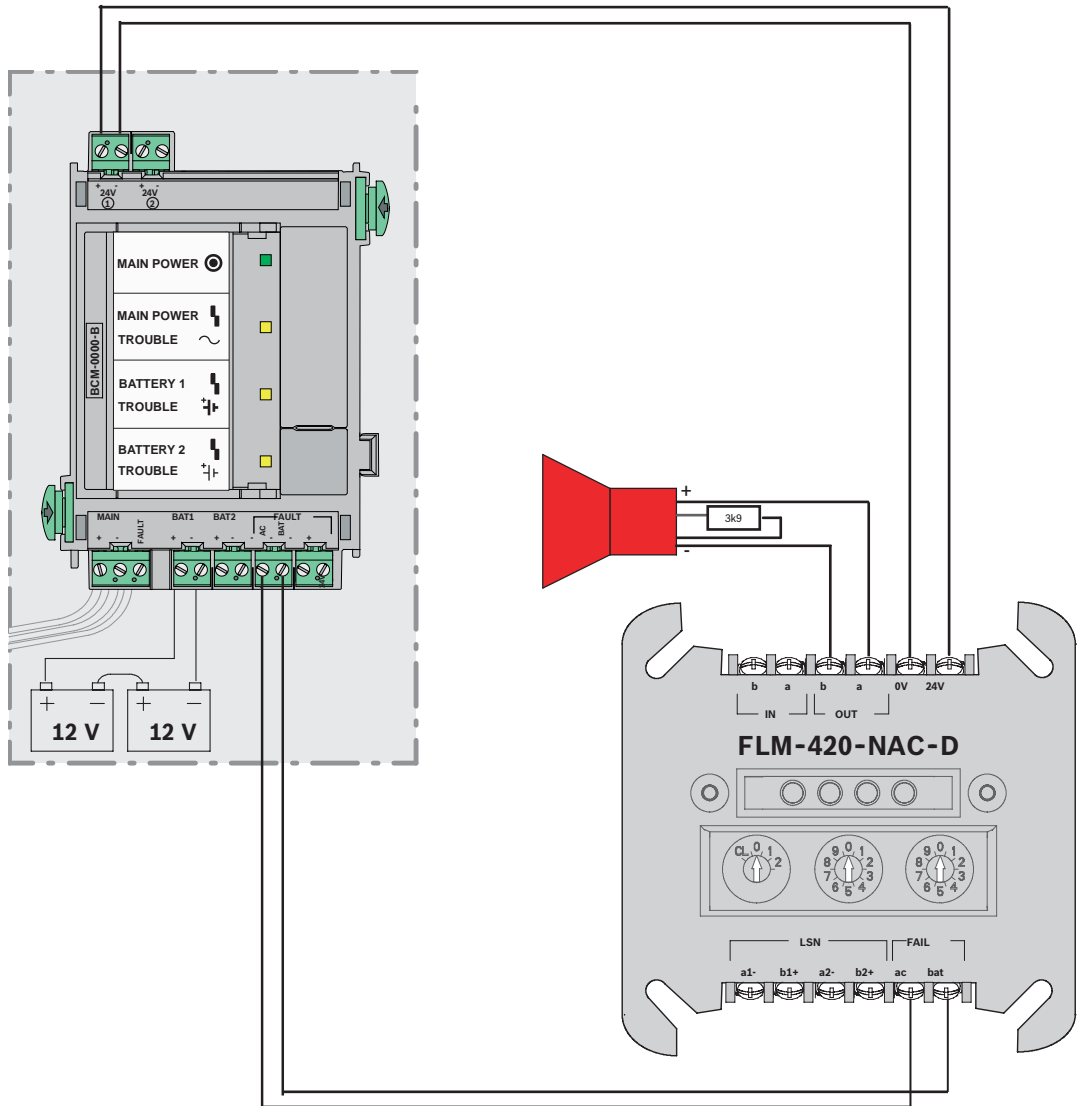
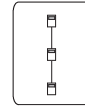

2.4.2 CZM 0004 A



Fireray 50RV
Fireray 100RV

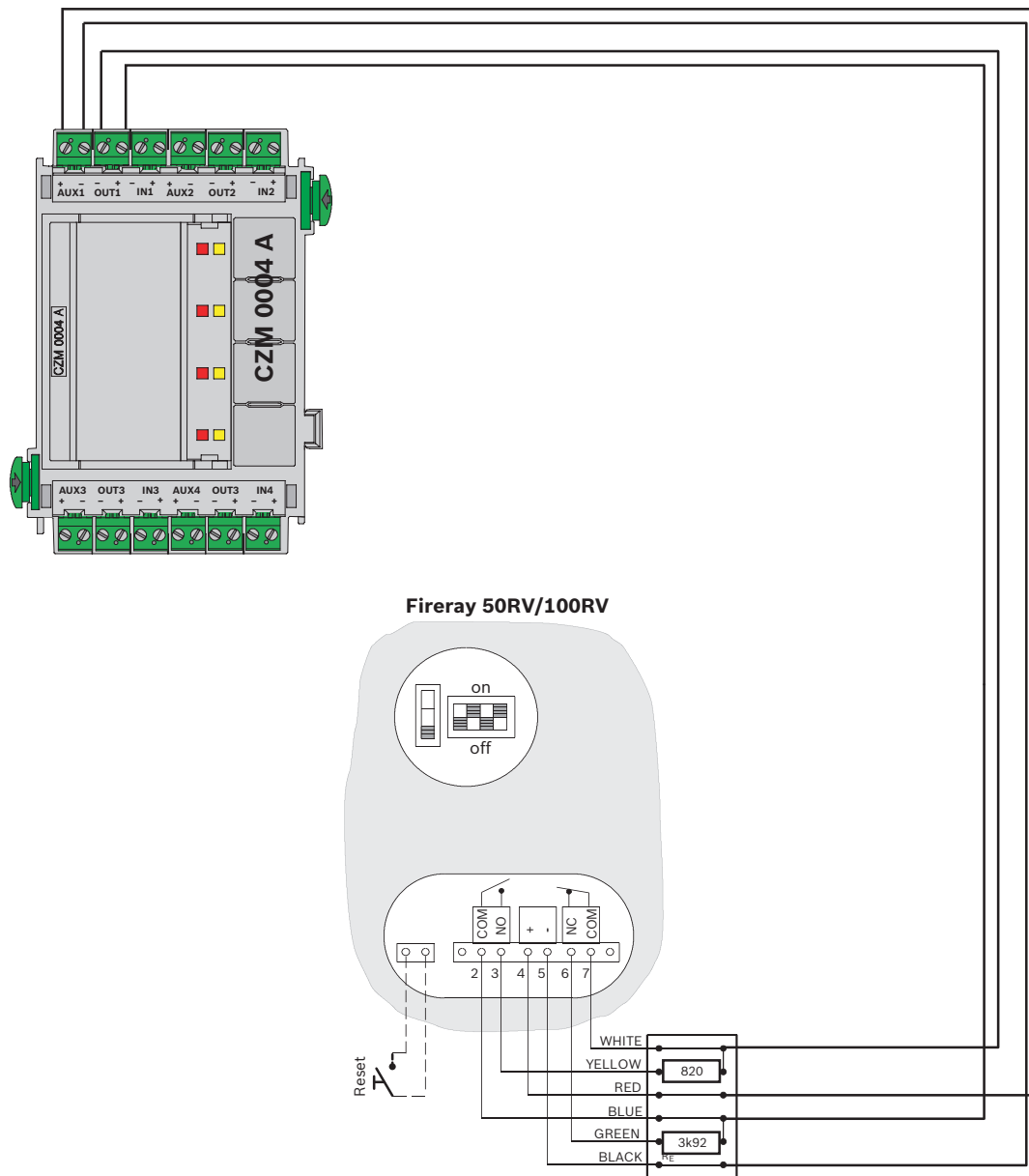

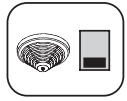

FIRERAY3000

1 x



BCM-0000-B
LSN 0300 A
LSN 1500 A

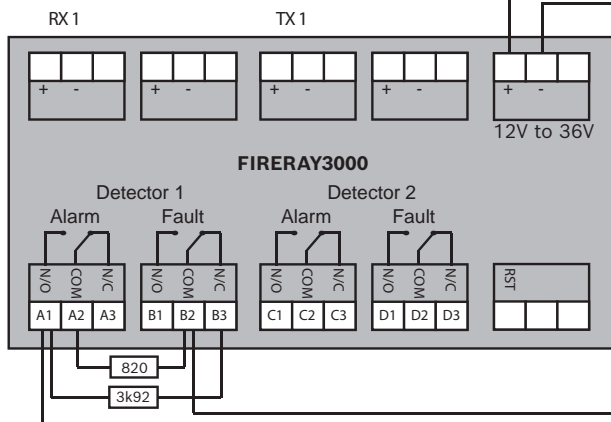
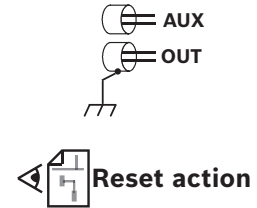
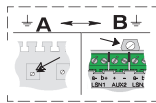
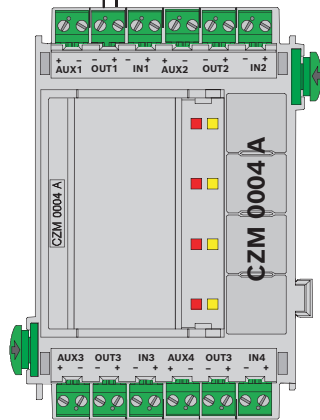



FIRERAY3000
2 x  **OUT1**



BCM-0000-B
LSN 0300 A
LSN 1500 A

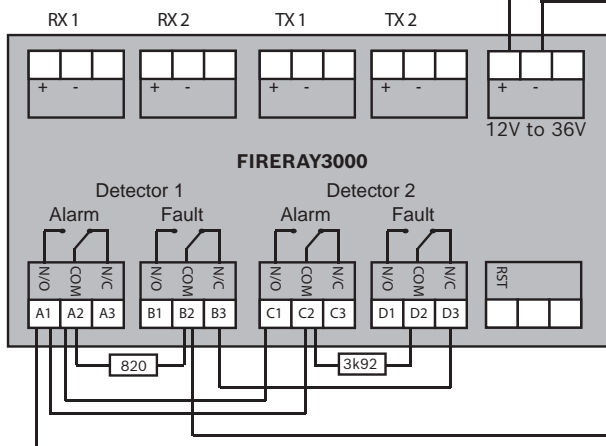
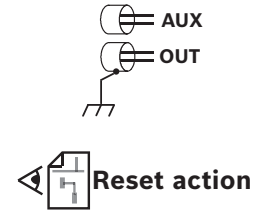
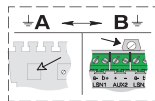
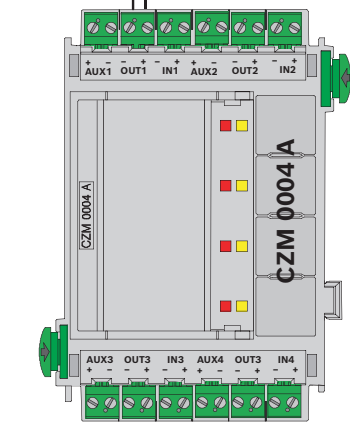



FIRERAY3000
2 x **OUT1+2**



BCM-0000-B
LSN 0300 A
LSN 1500 A

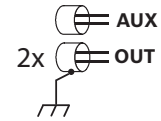
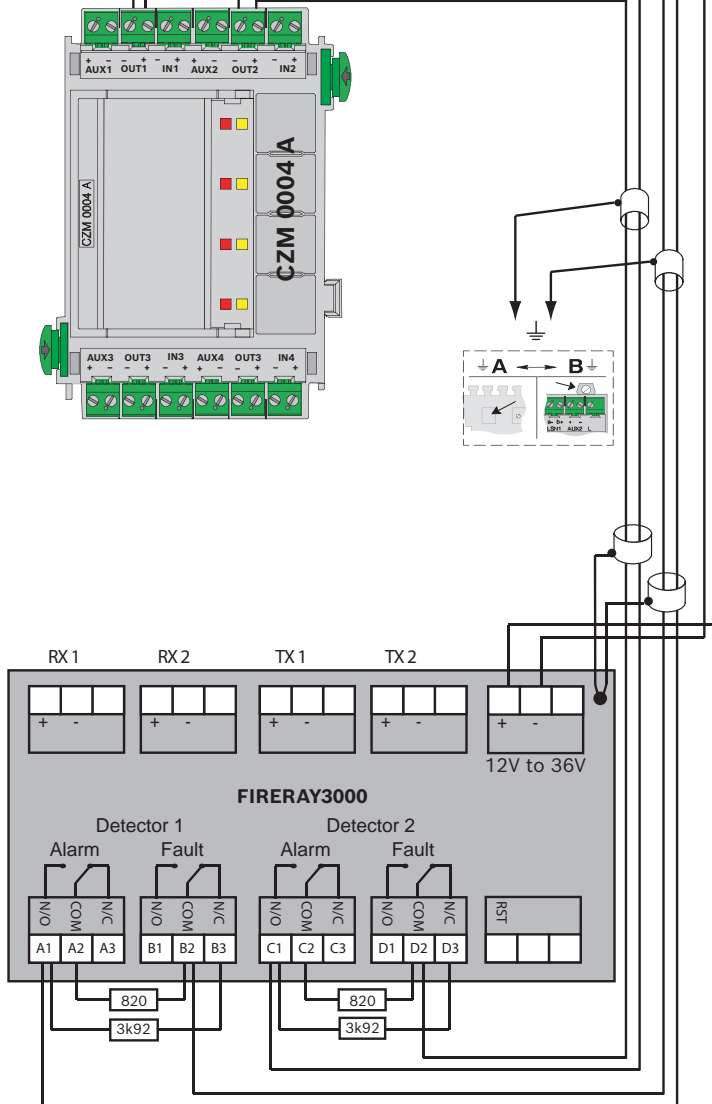

Reset action

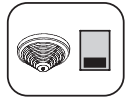

FIRERAY5000

1 x



BCM-0000-B
LSN 0300 A
LSN 1500 A

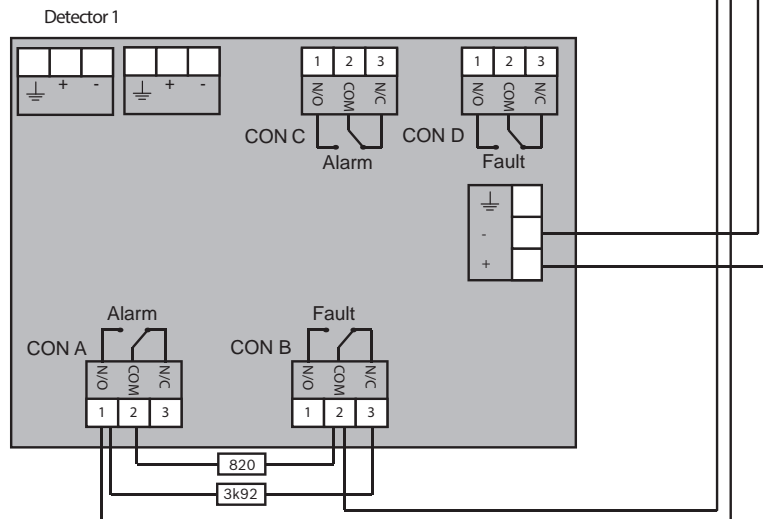
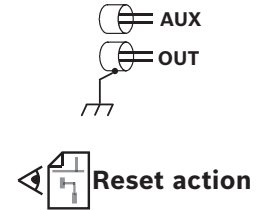
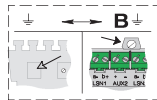
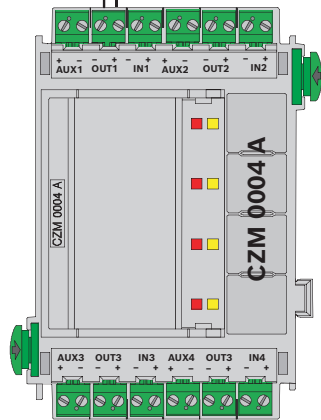



FIRERAY5000

2 x OUT1

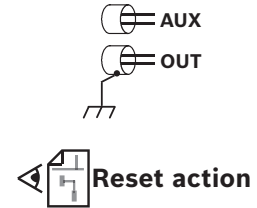
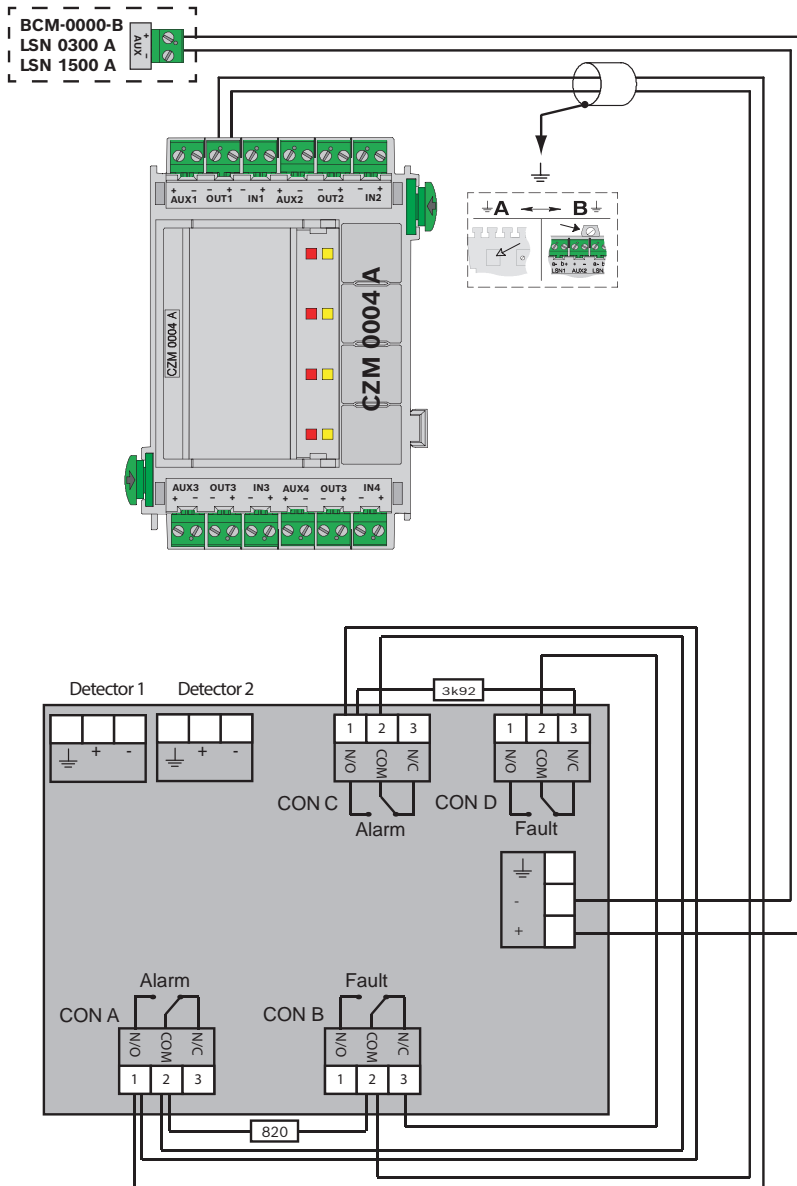

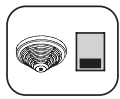

FIRERAY5000
2 x  **OUT1**

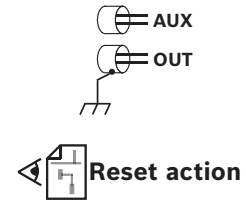
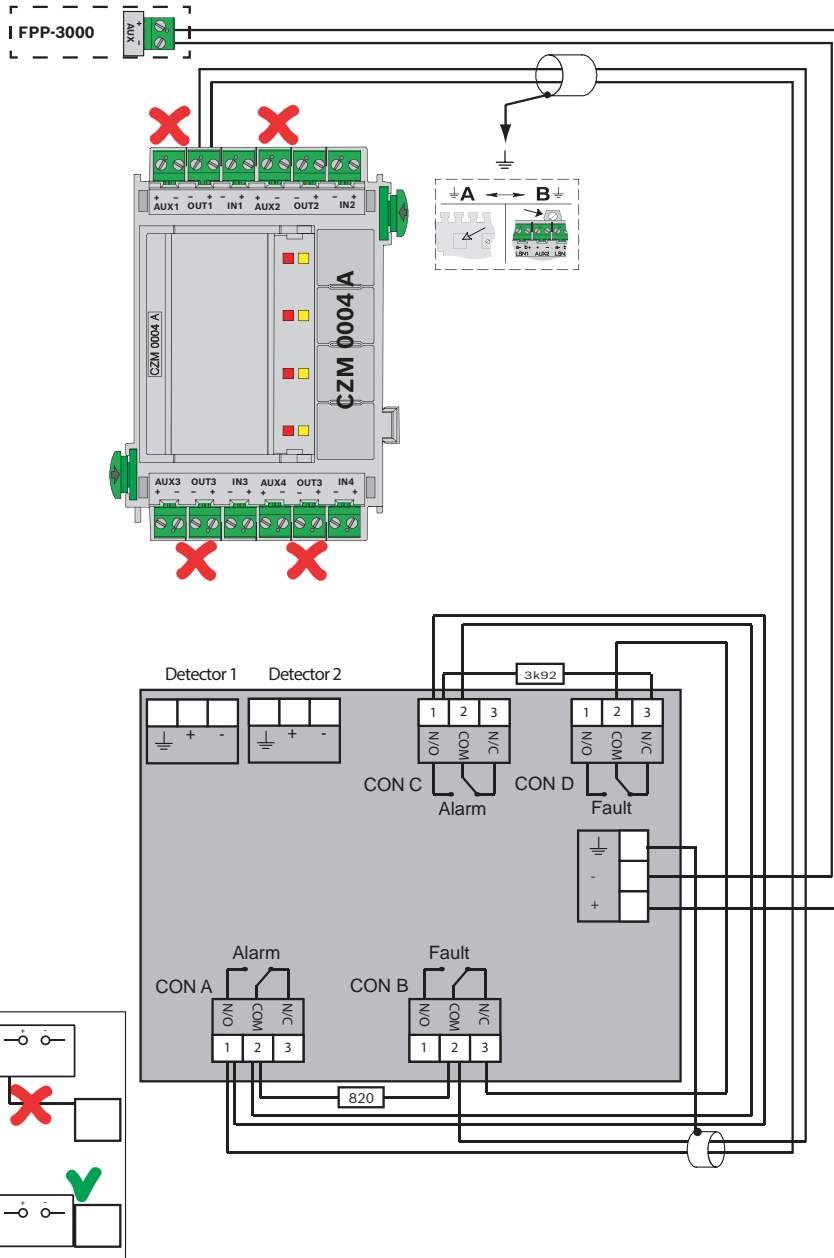

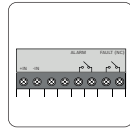

**016519, 016589
IR3 Flame Detector**

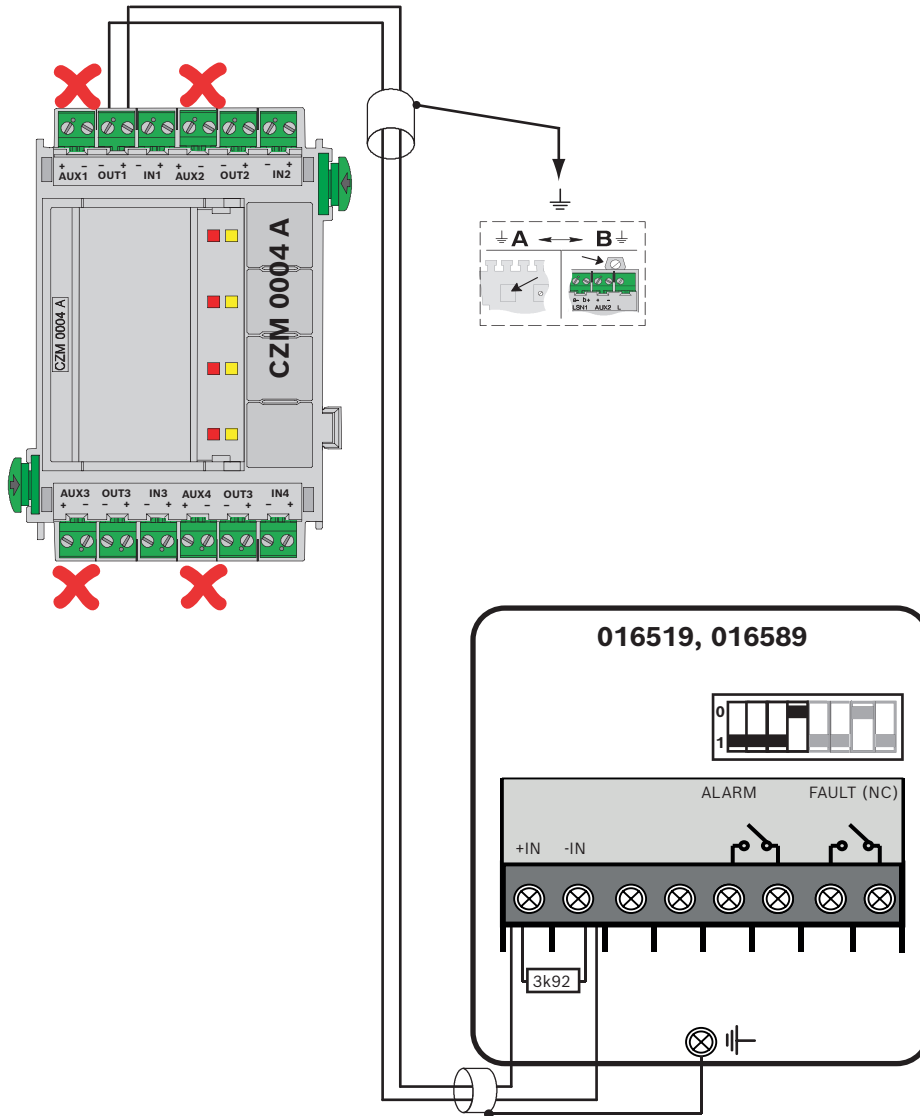
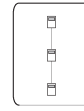

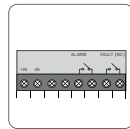

**016519, 016589
IR3 Flame Detector**

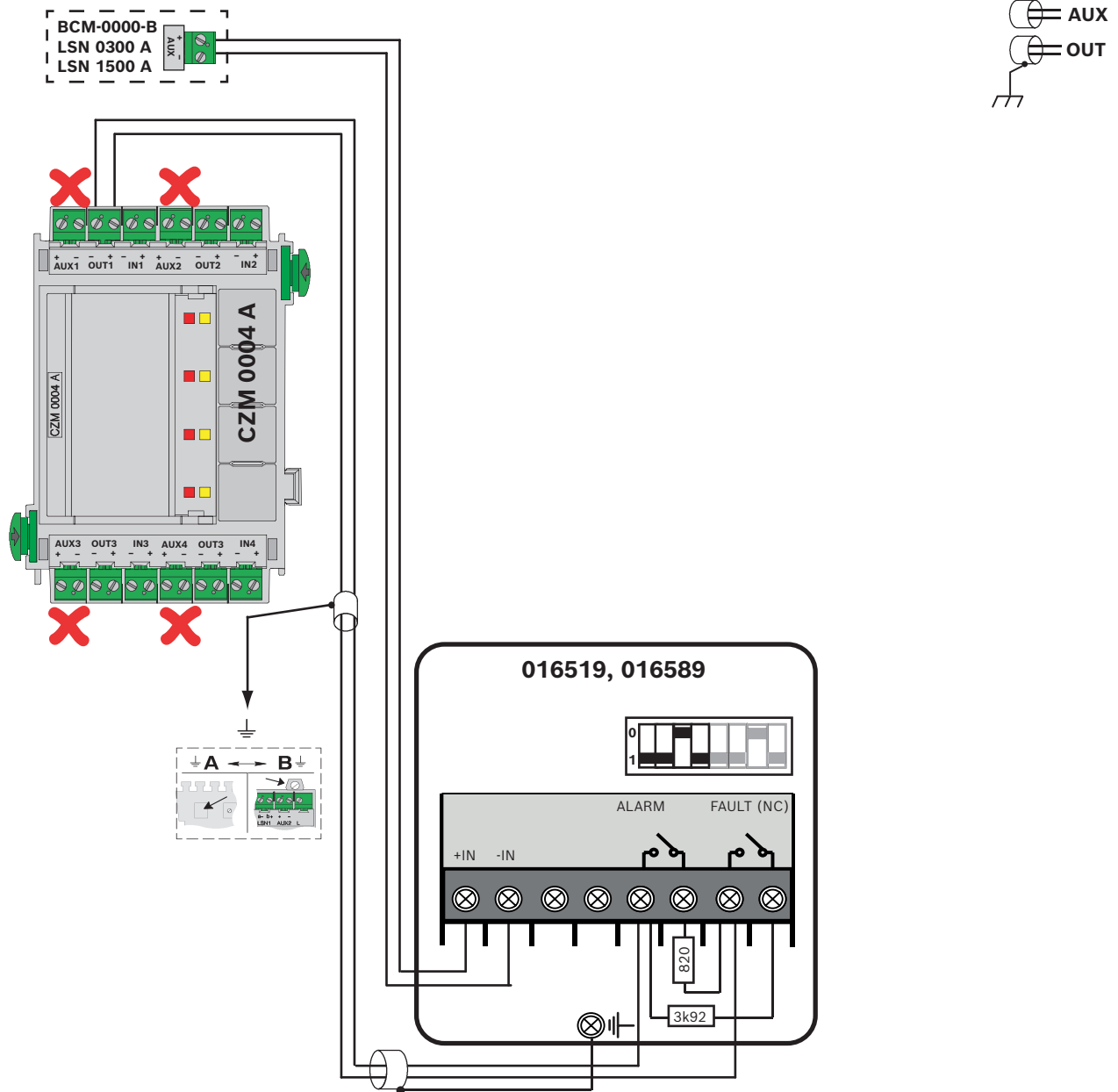
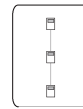

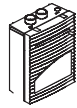

FCS-320-TM Series

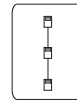

BCM-0000-B
LSN 0300 A
LSN 1500 A

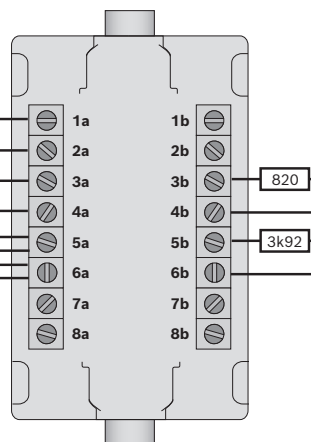
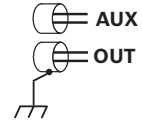
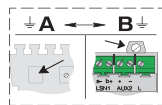
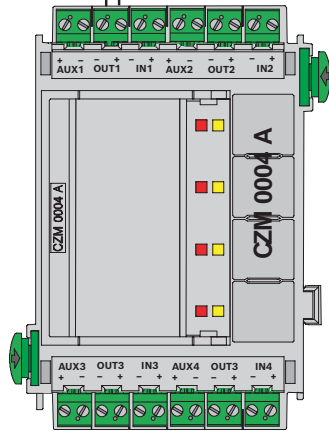

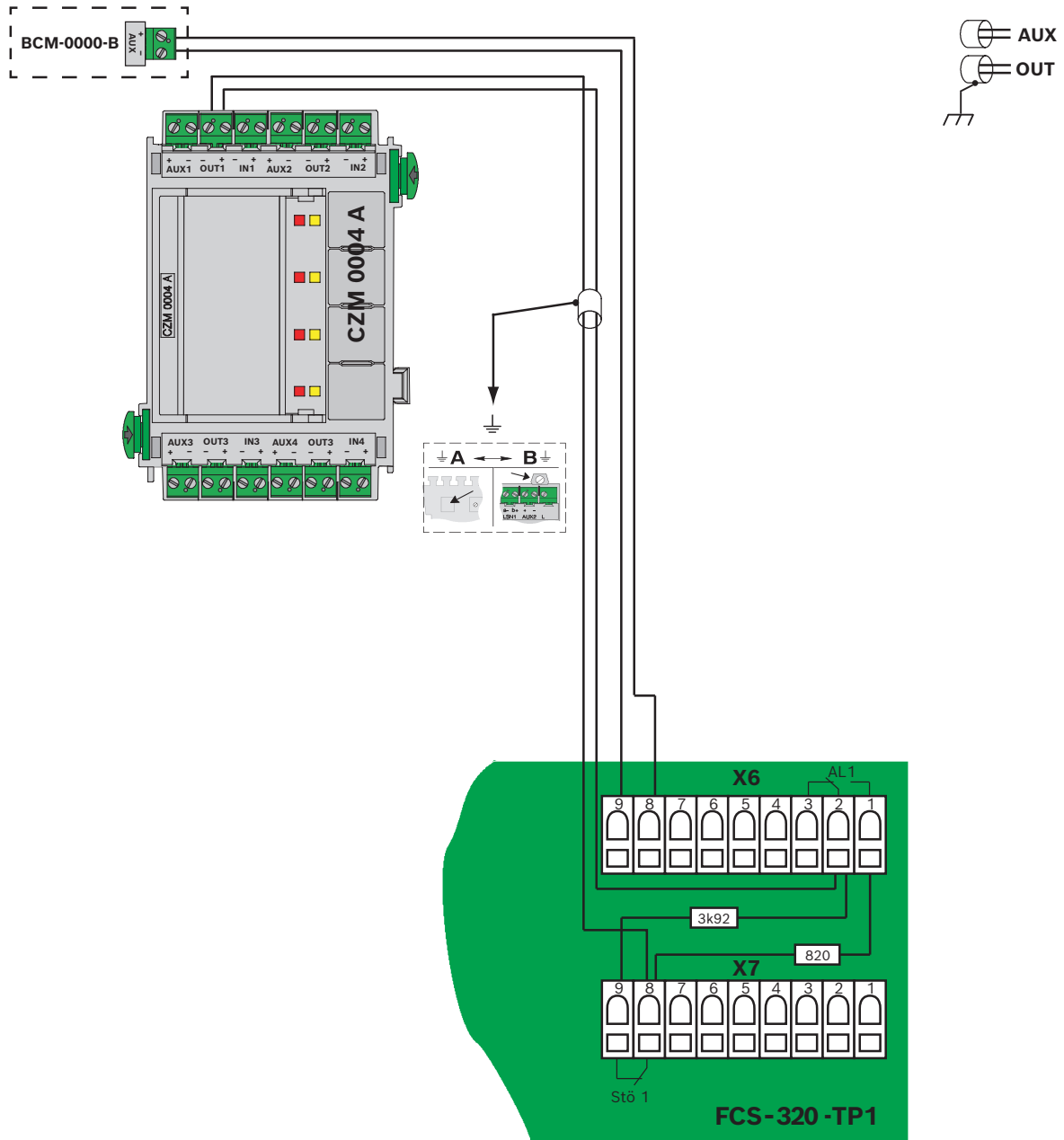
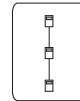
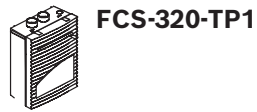

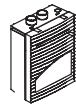

FCS-320-TP2

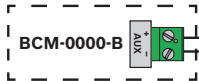

BCM-0000-B

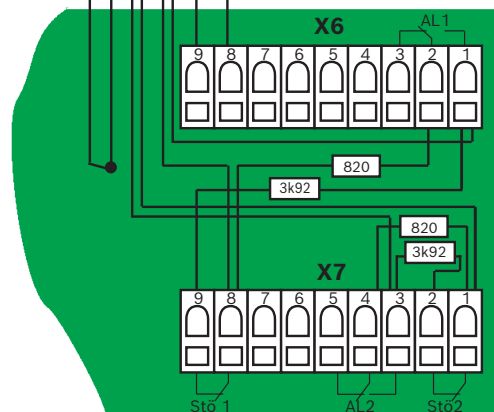
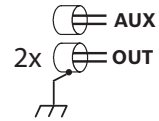
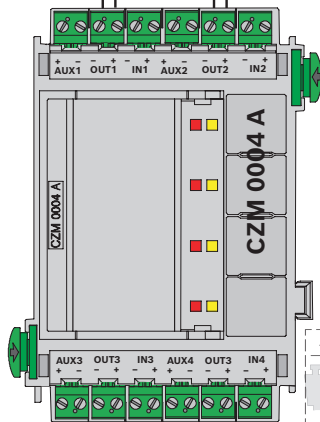

FCS-320-TP2



FCS-LWM-1

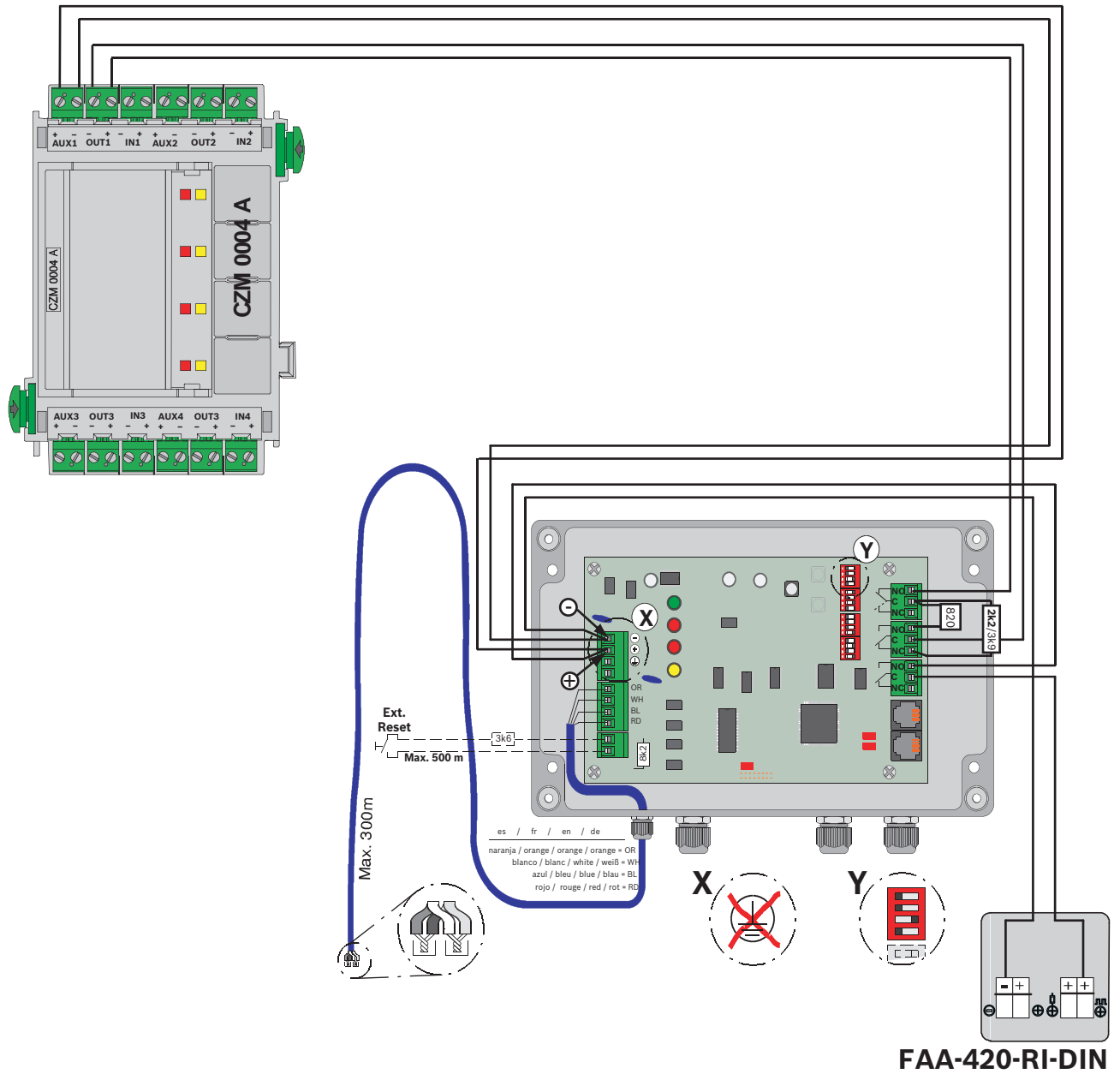



FCA-500-EU
 FCP-O 500
 FCP-O 500-P
 FCP-OC 500
 FCP-OC 500-P

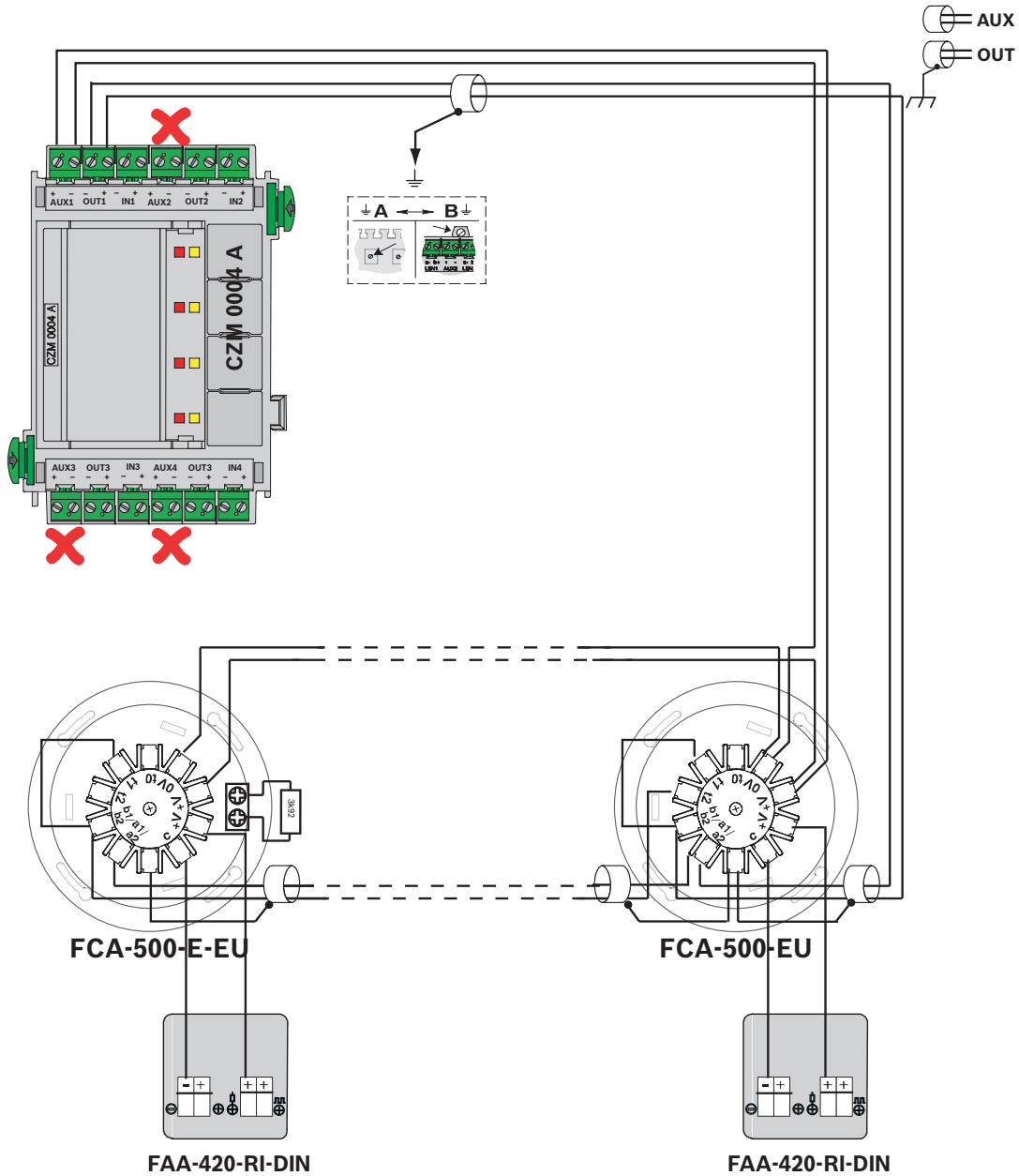

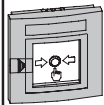

FMC-120-DKM-G-R
FMC-120-DKM-H-R
FMC-120-DKM-G-B
FMC-120-DKM-H-B
FMC-120-DKM-G-Y

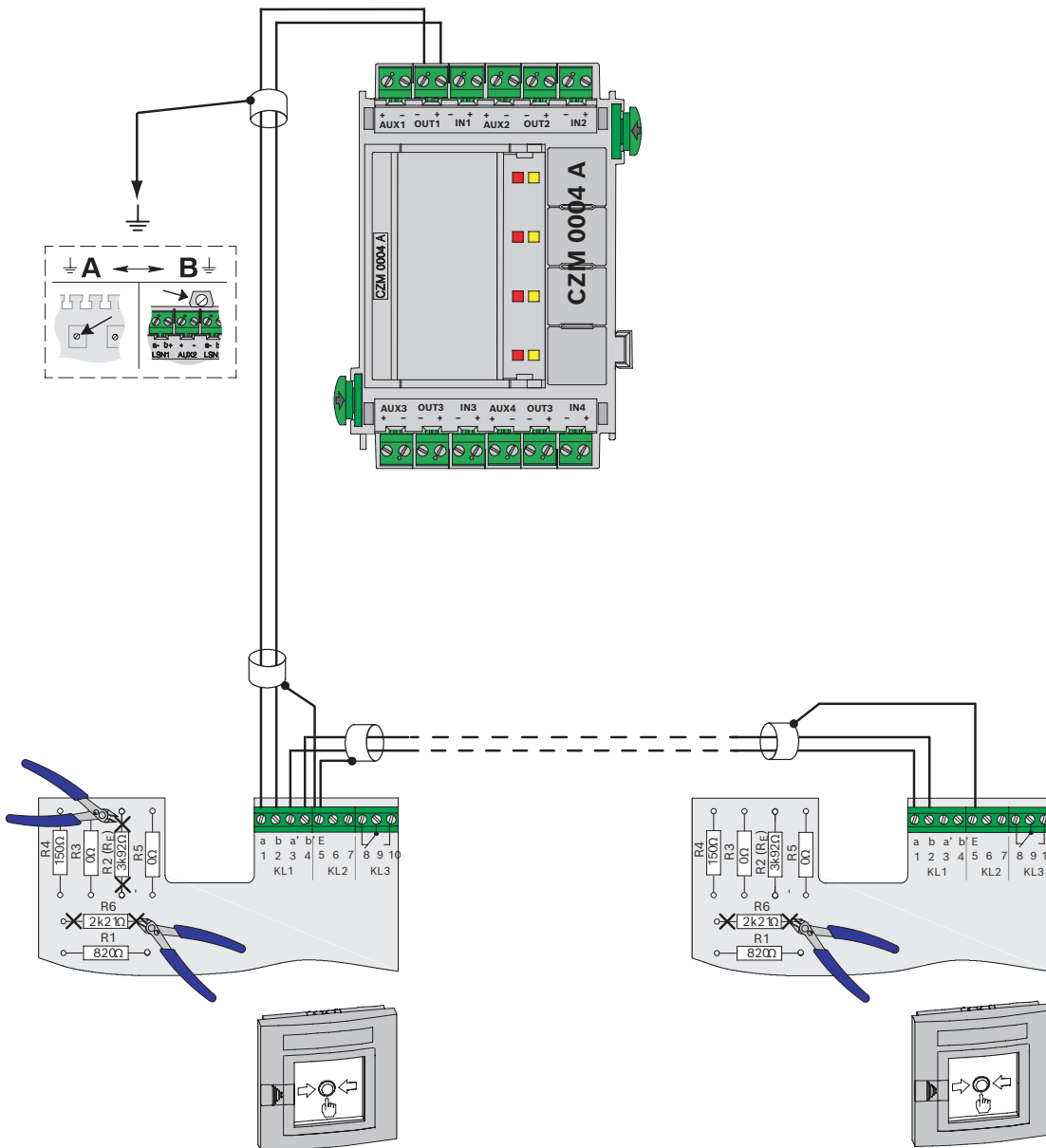
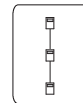

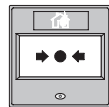
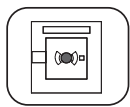

FMC-300RW-GSGBU
FMC-300RW-GSRBU
FMC-300RW-GSGRD
FMC-300RW-GSRRD
FMC-300RW-GSGYE
FMC-300RW-GSRYE

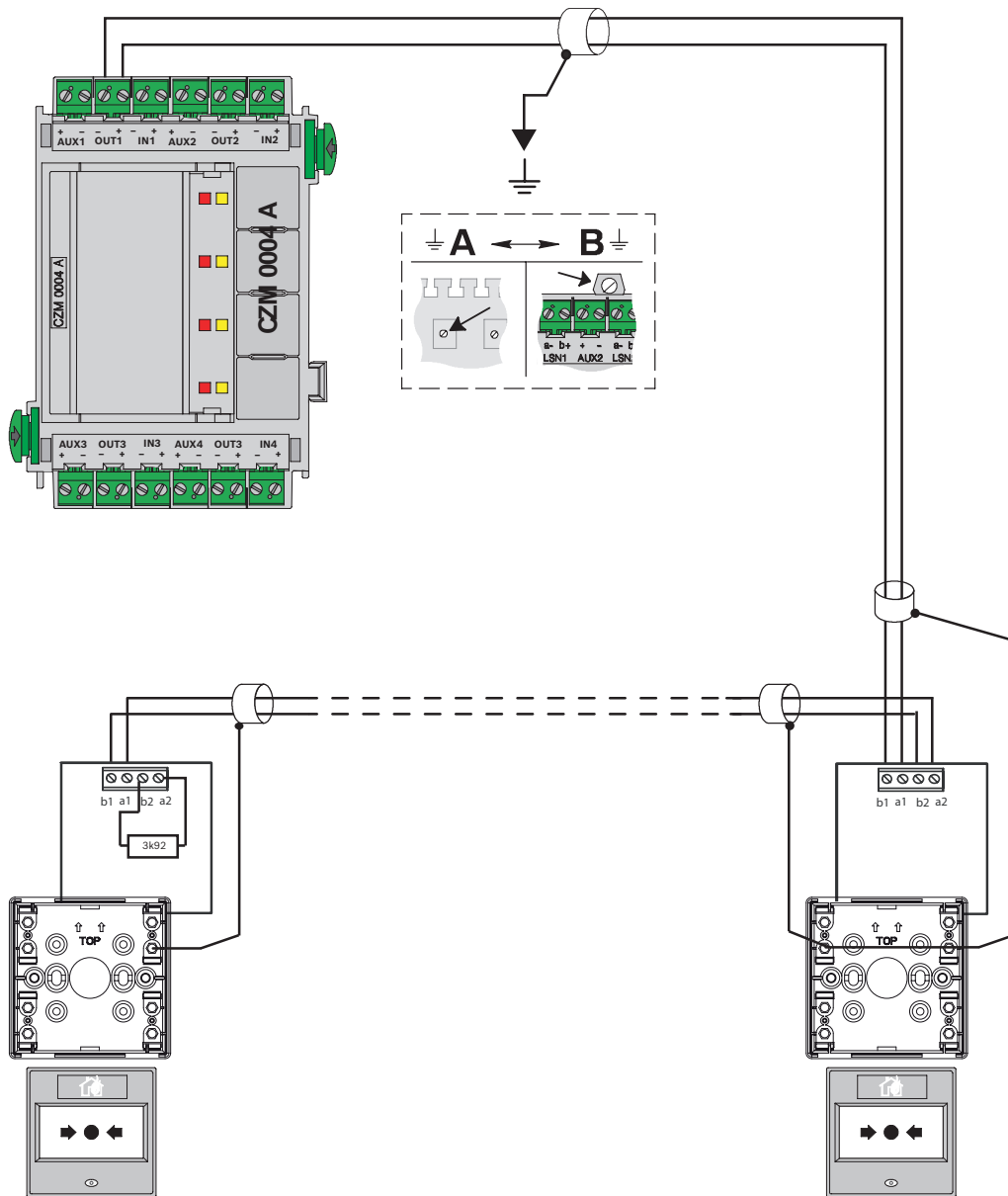
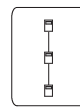

2.4.3 ENO 0000 A/B



AT5000 IP/GPRS

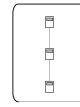

EN 54-2

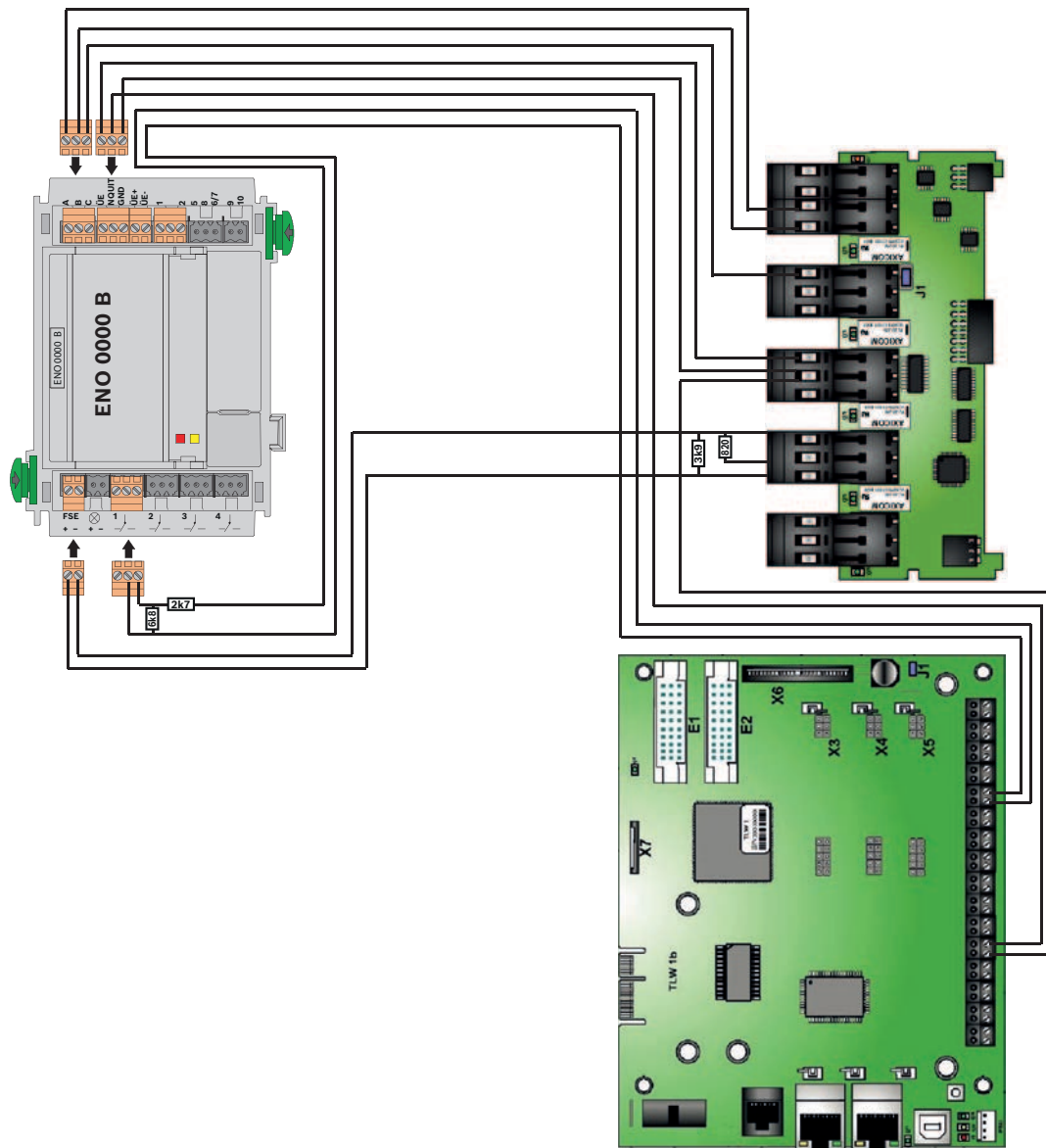

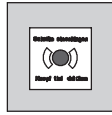
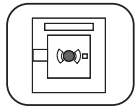

MDL-F

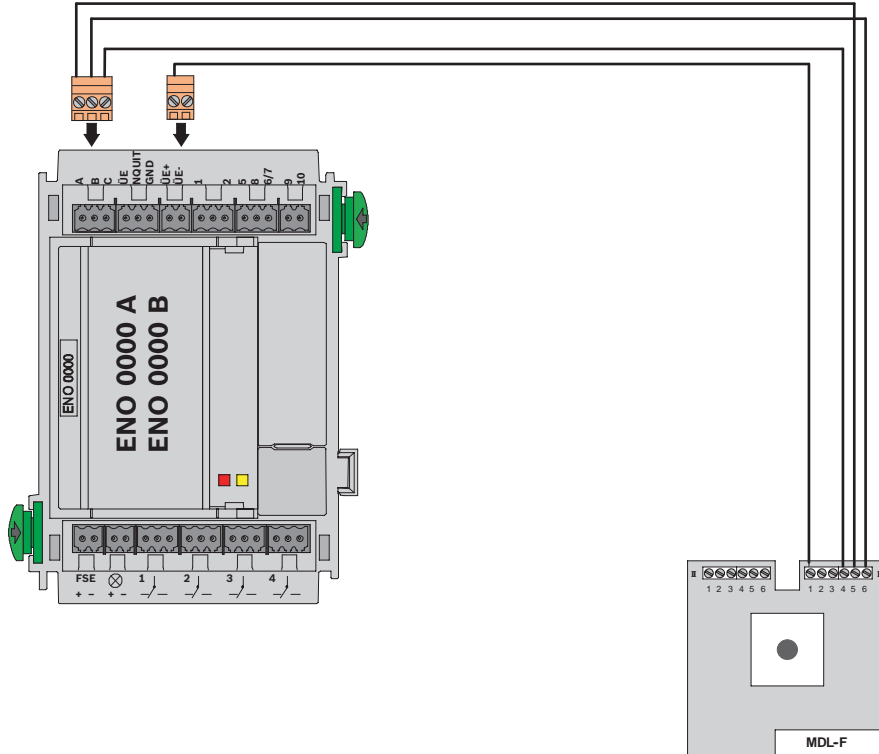

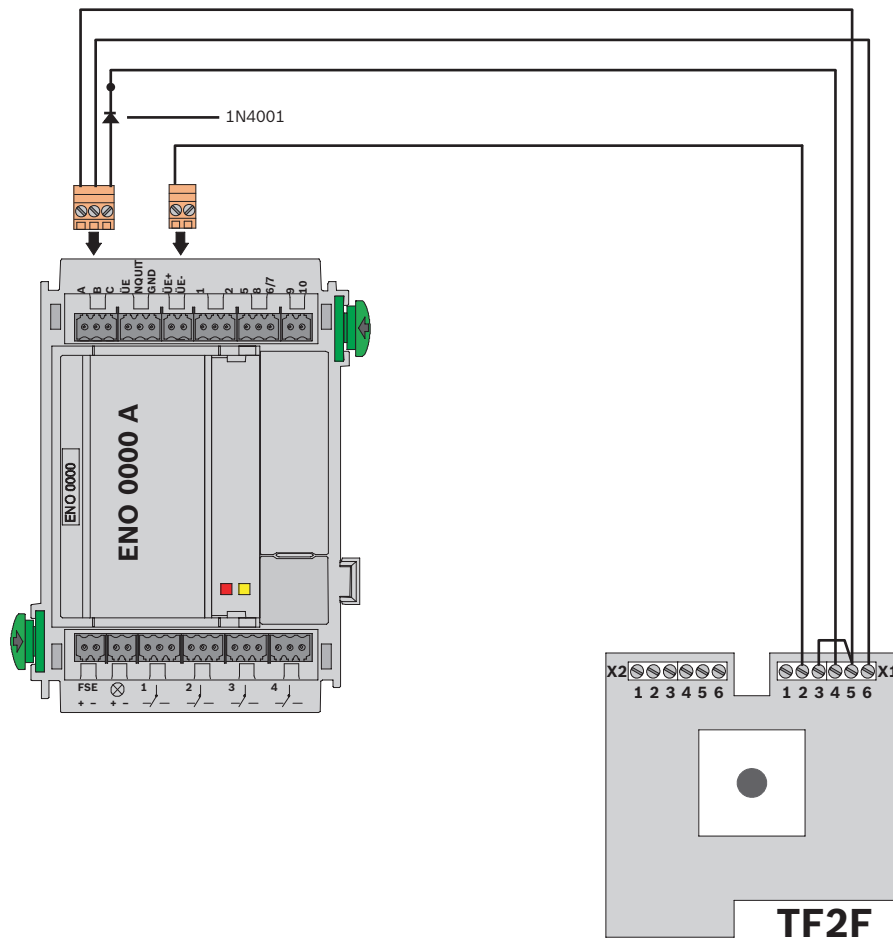
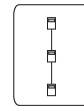
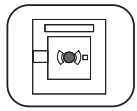

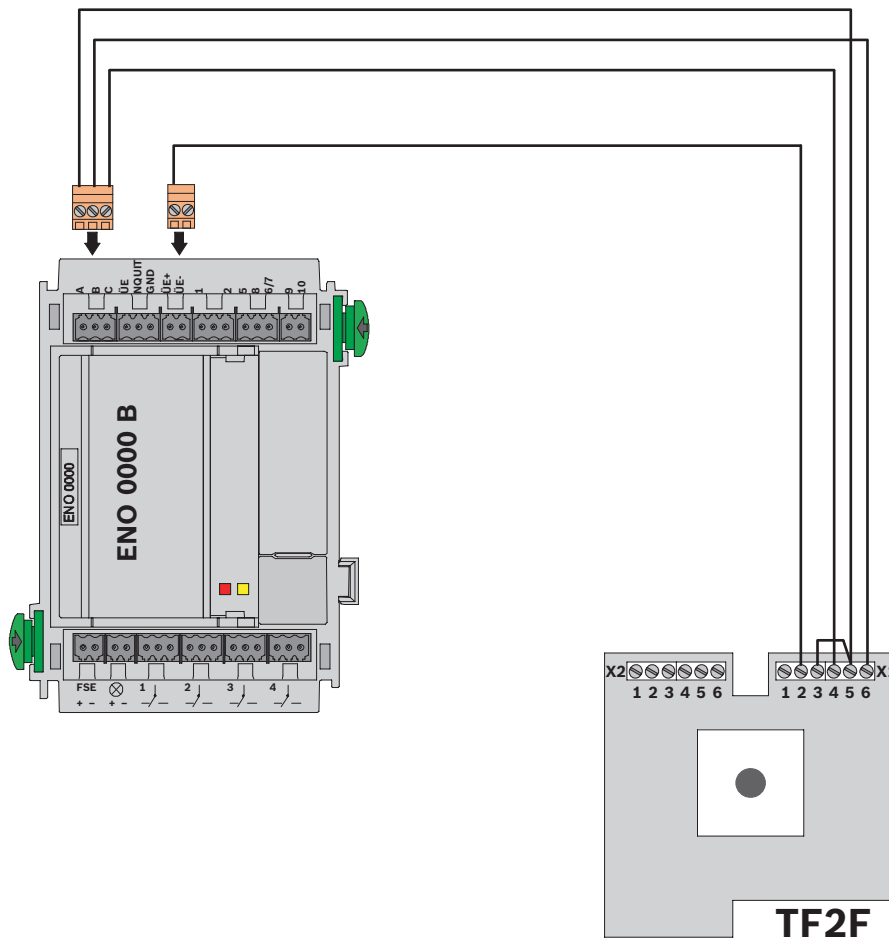
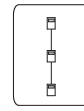
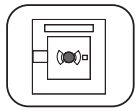

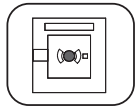

UE-F-D/T

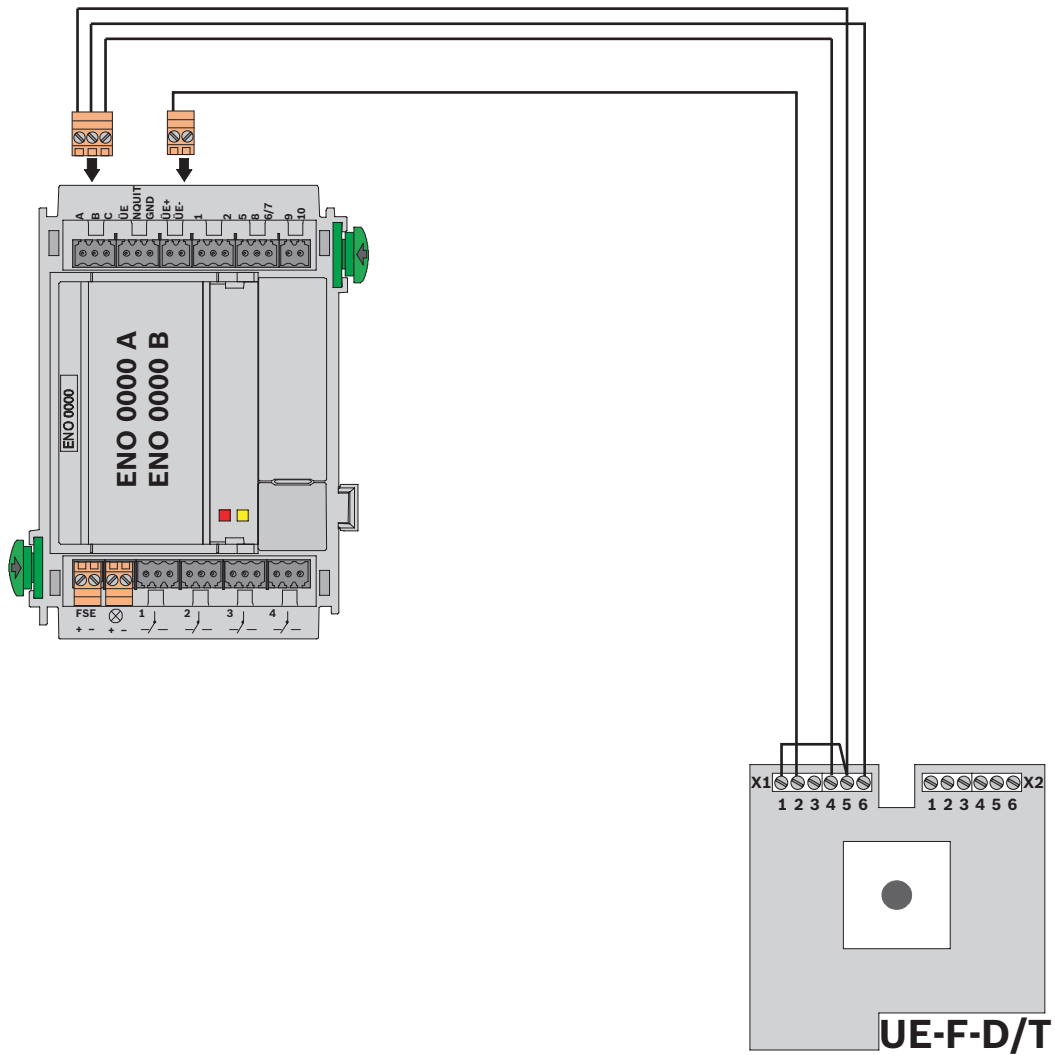

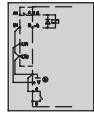

GÜ 101-B

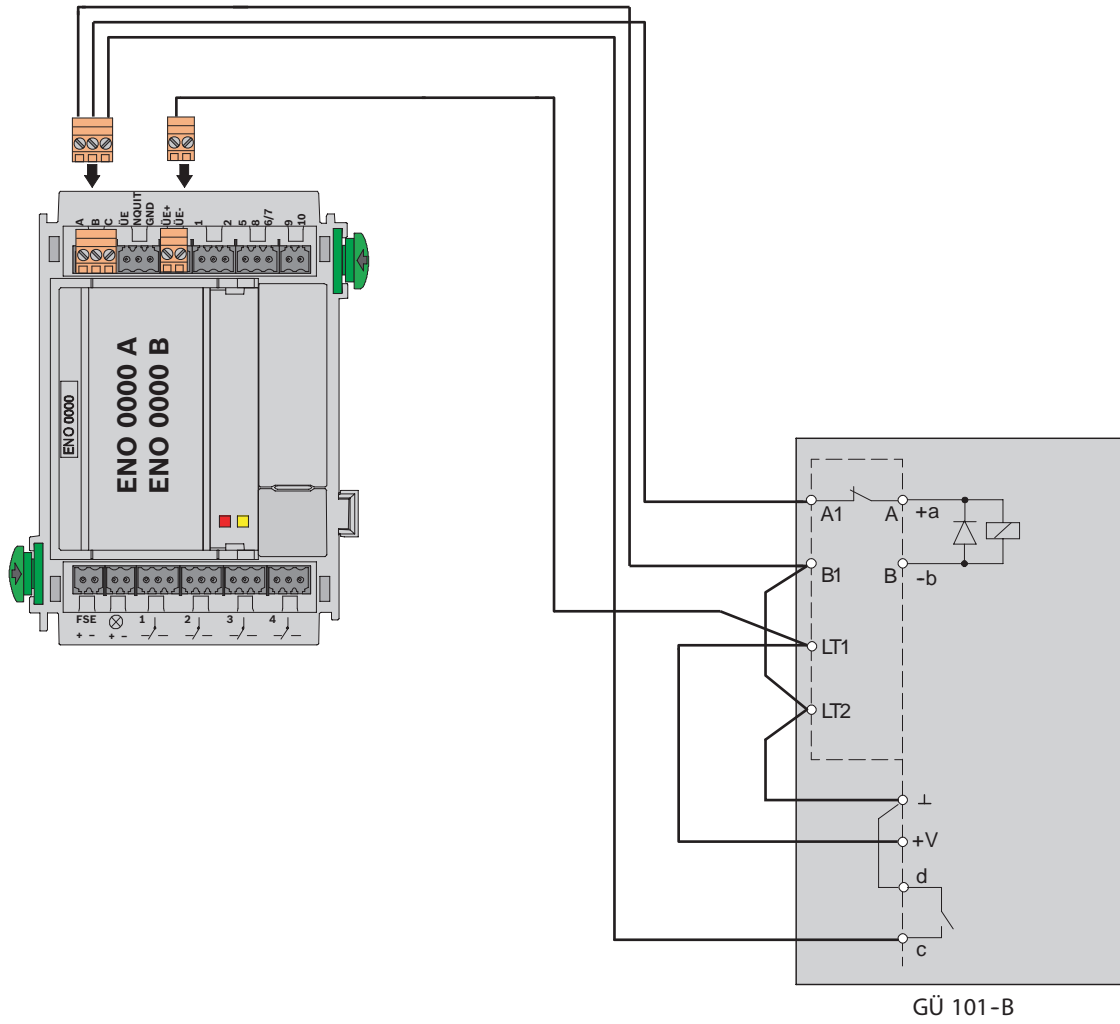
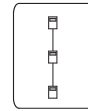

GÜ 101-B

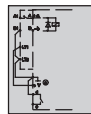

GÜ 101-B

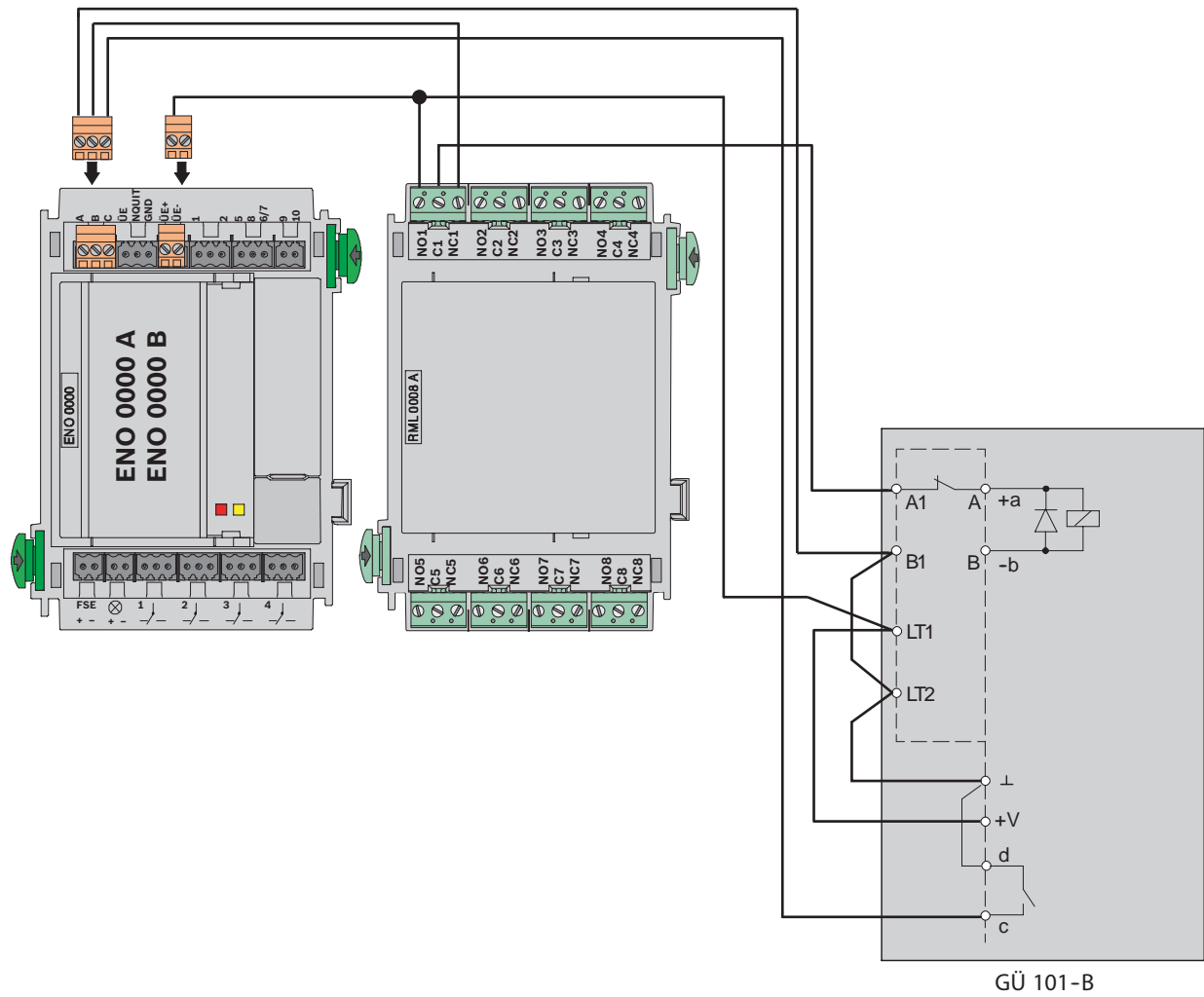
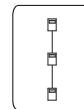

2.4.4

LSN 0300 A

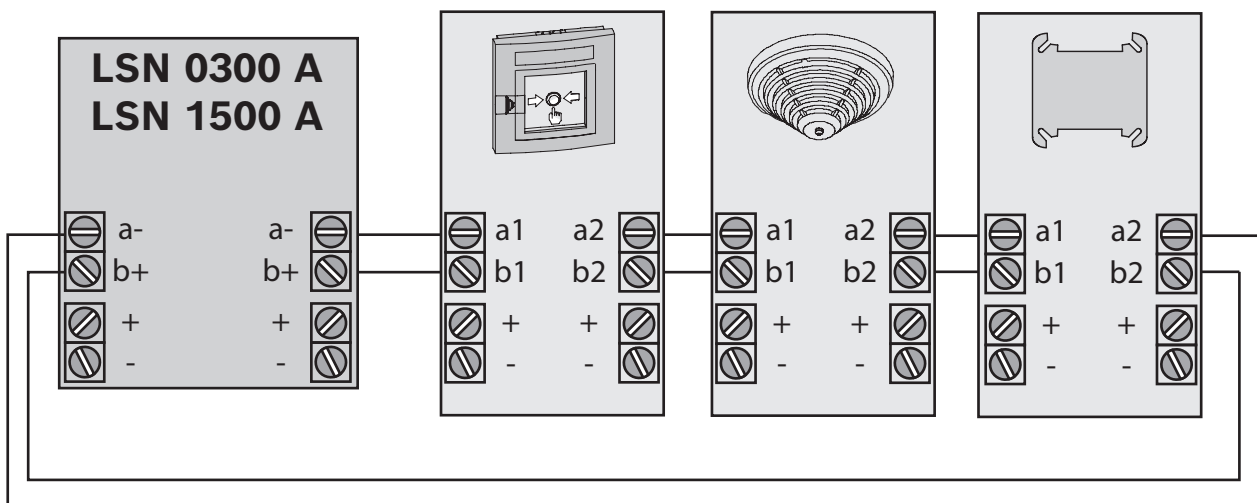
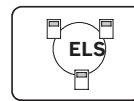

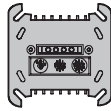
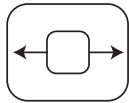

FLM-I 420-S
 FLM-420-I2-D
 FLM-420-O1I1-D
 FLM-420-RHV-D/S
 FLM-420-RLV1-D

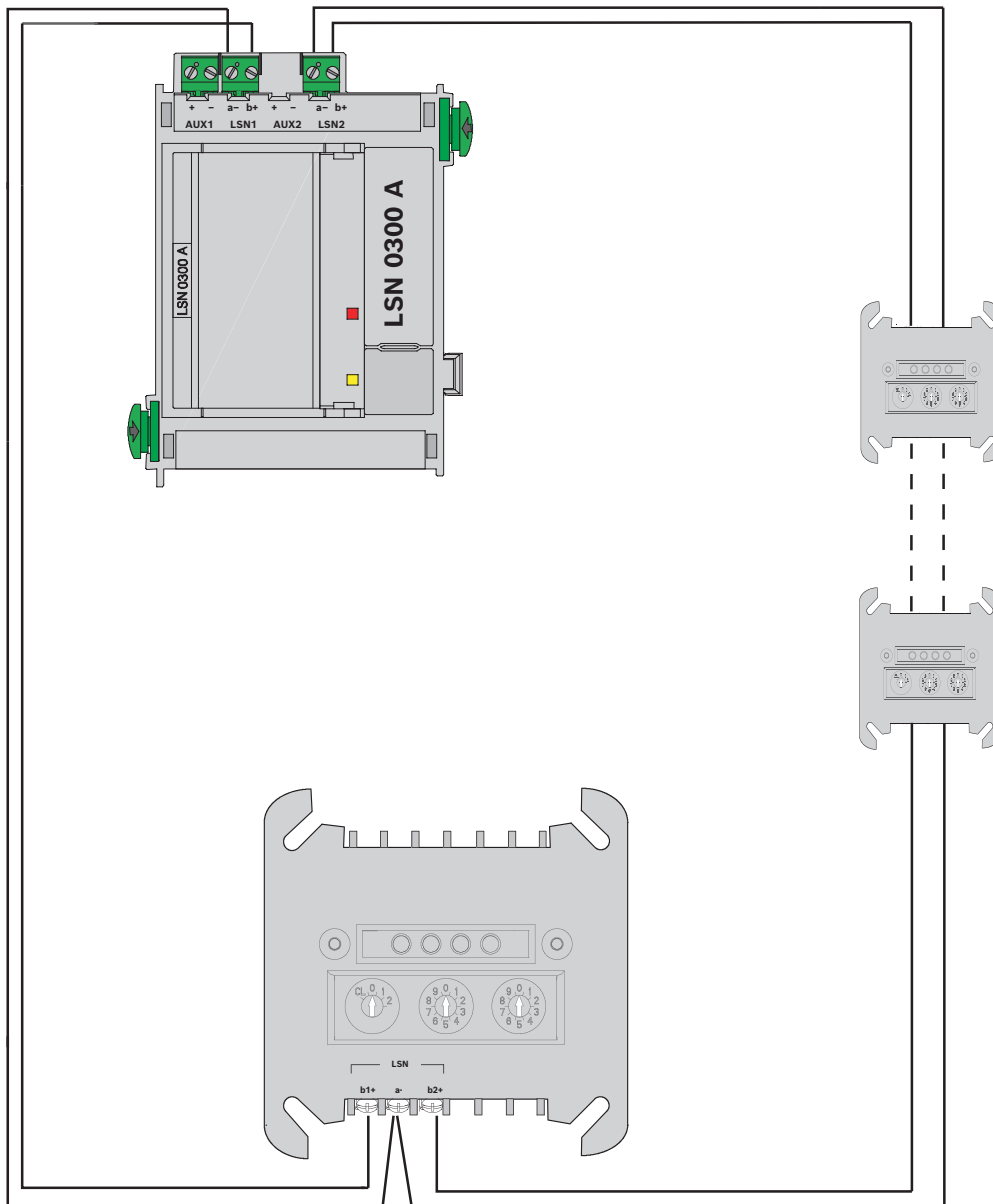
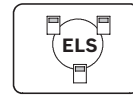

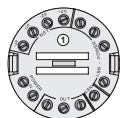
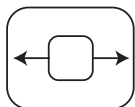

FLM-420-I2-E/W
FLM-420-RLV1-E

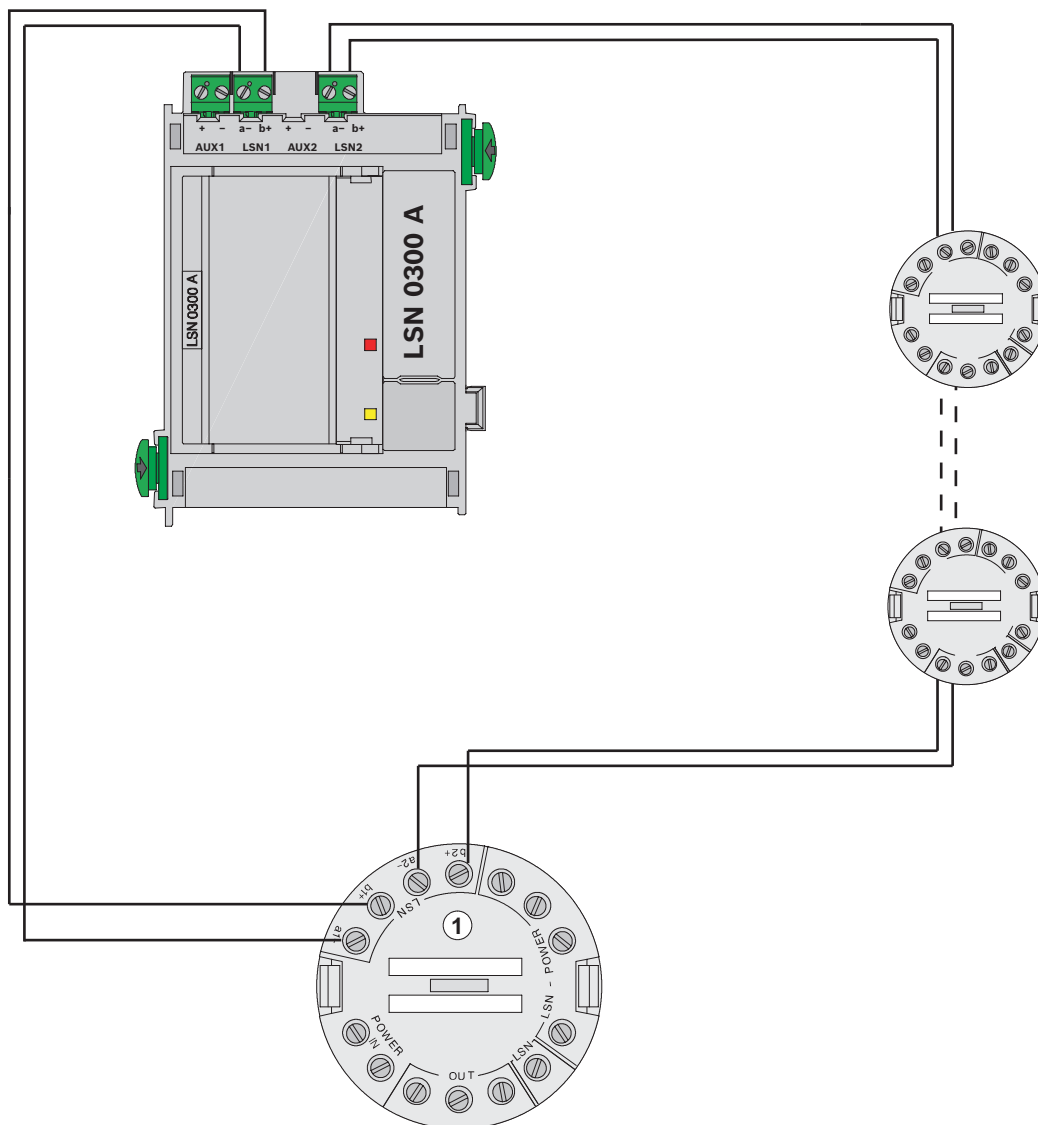
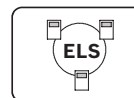

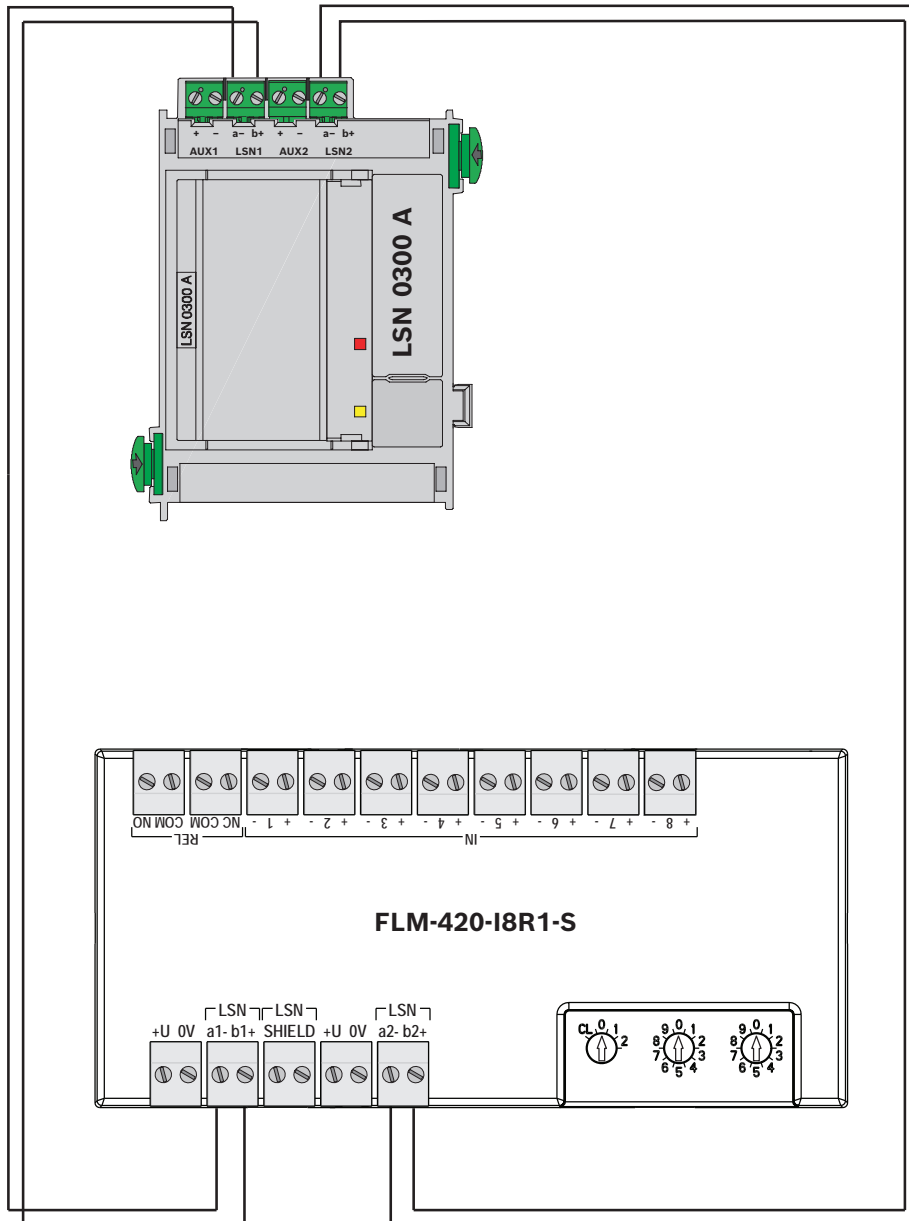
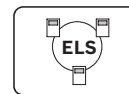
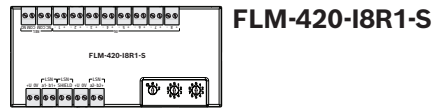
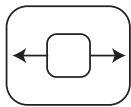

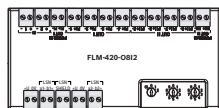
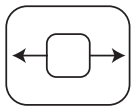

FLM-420-0812-S

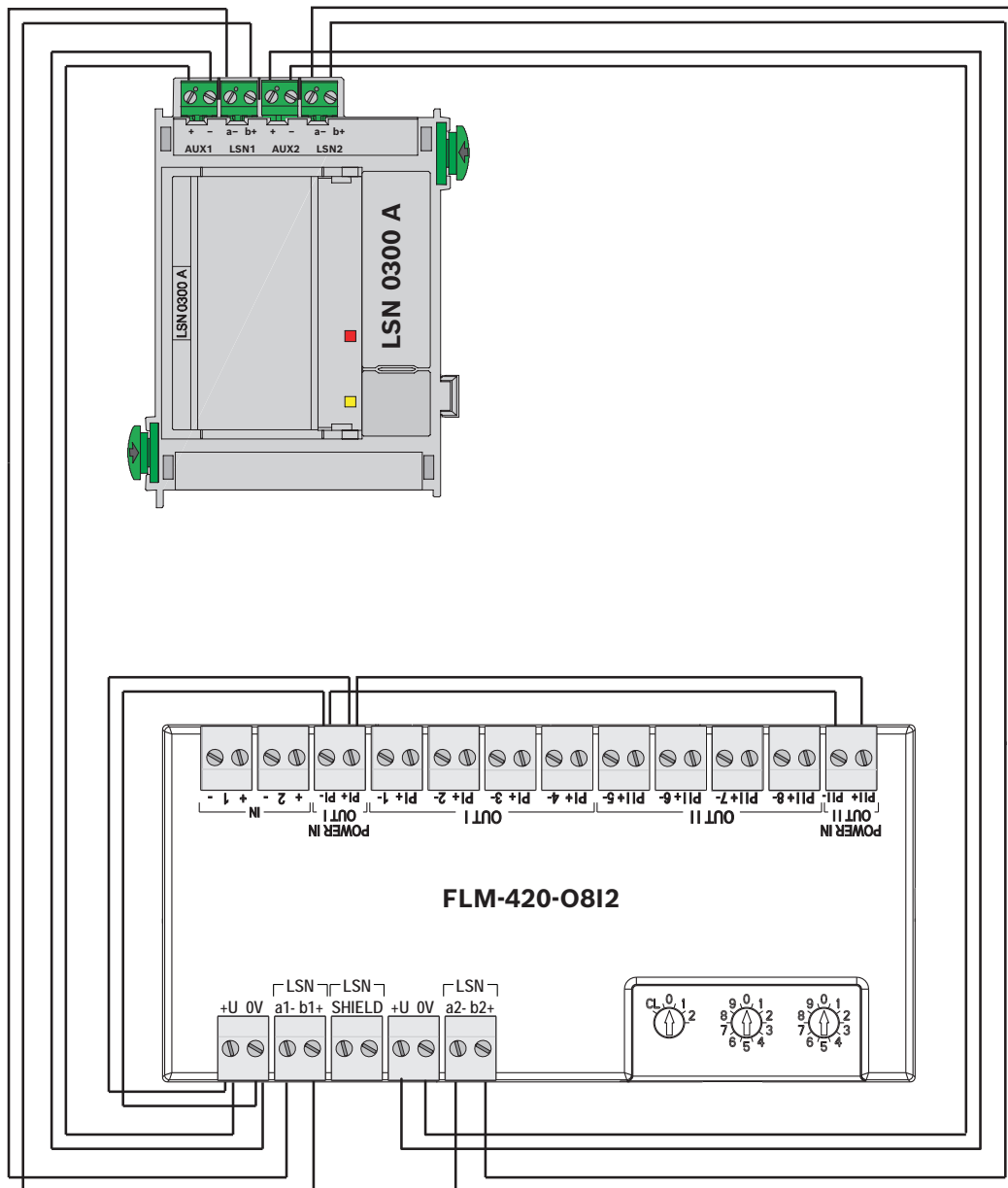
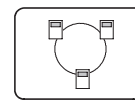

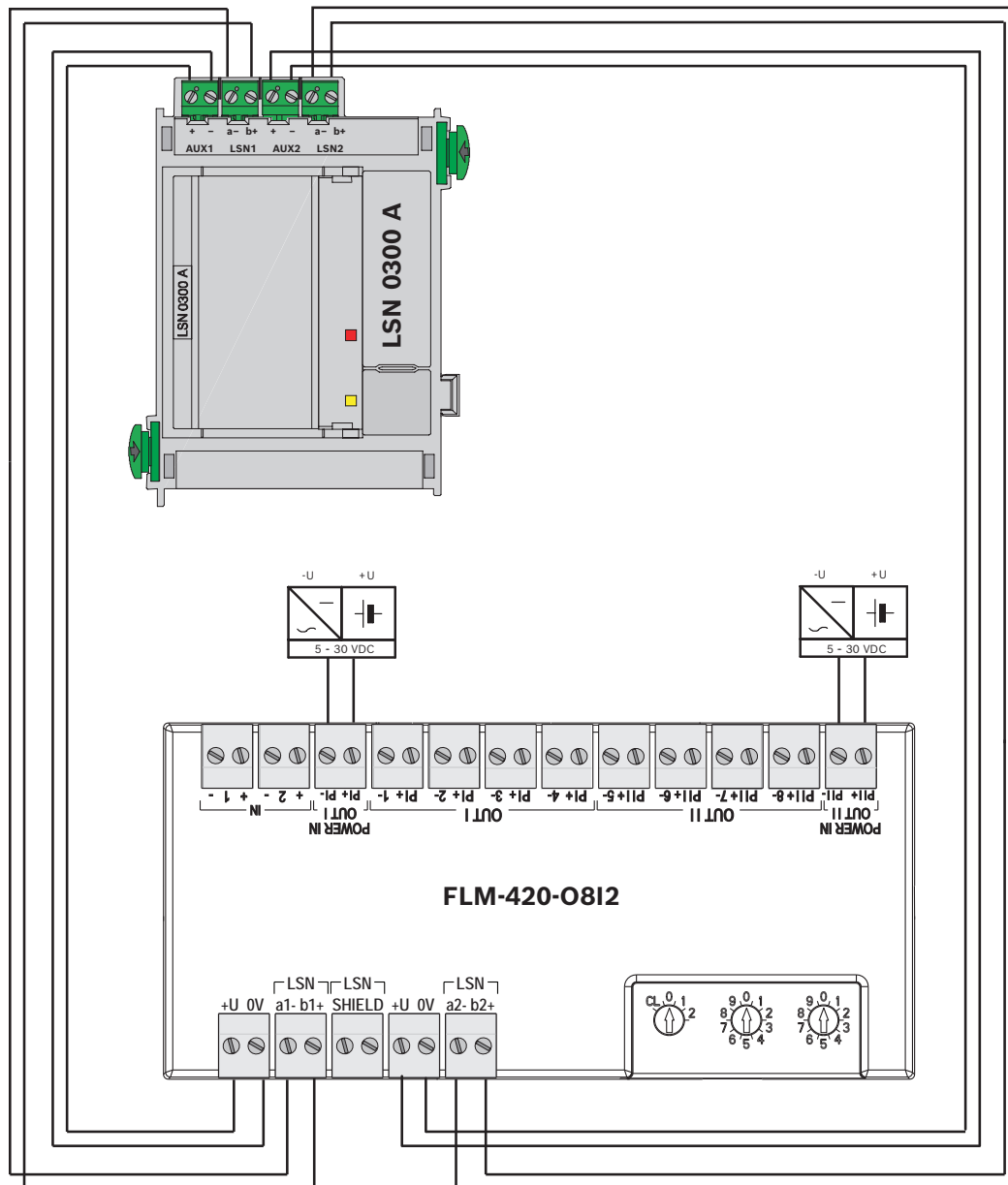
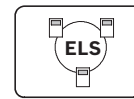
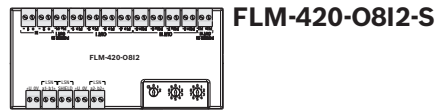
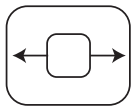

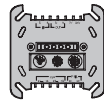
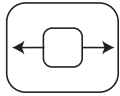

FLM-420-NAC-D/S

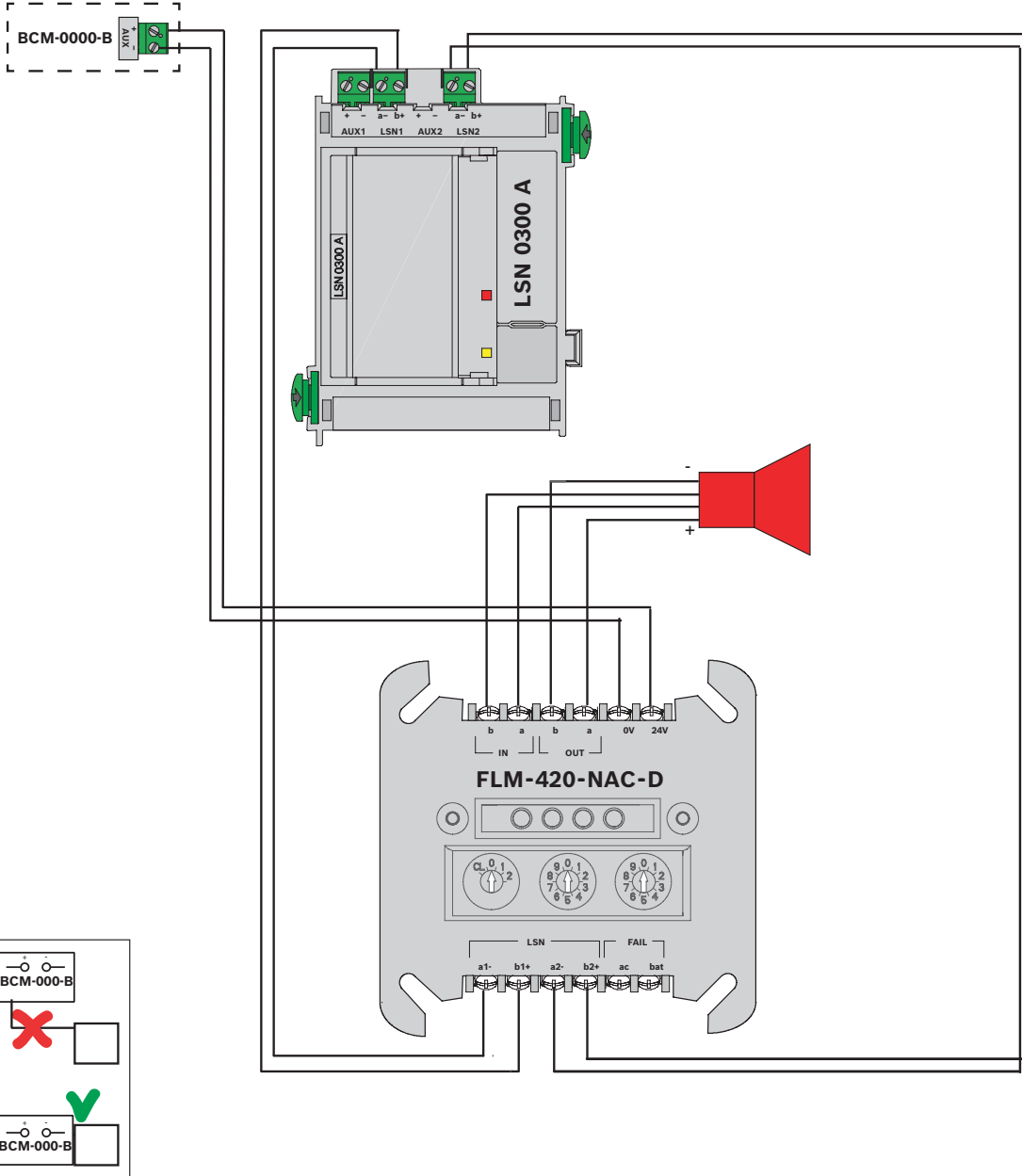
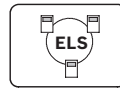

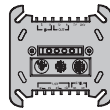
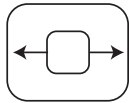

FLM-420-NAC-D/S

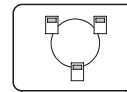

EN 54-2

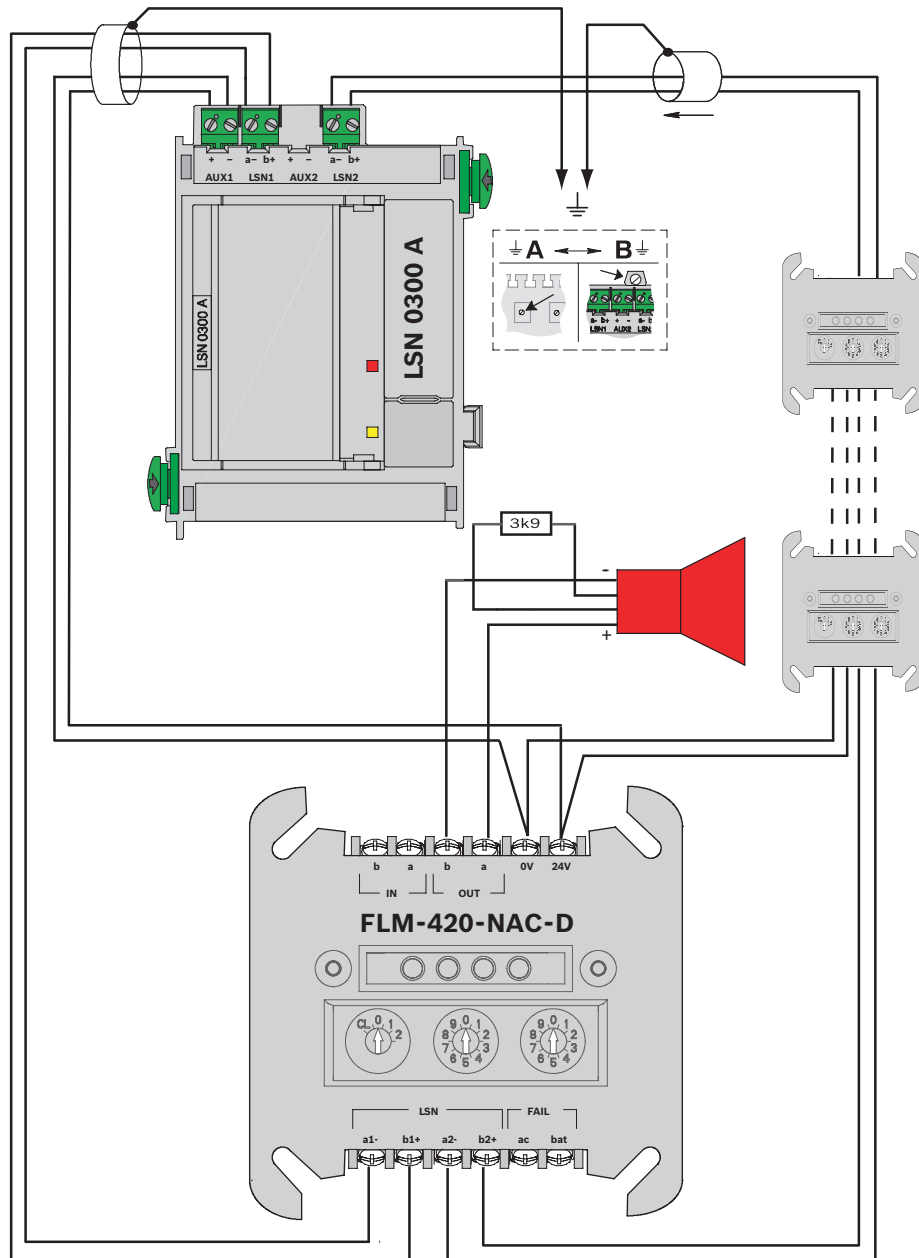

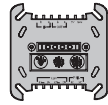
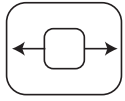

FLM-420-NAC-D/S

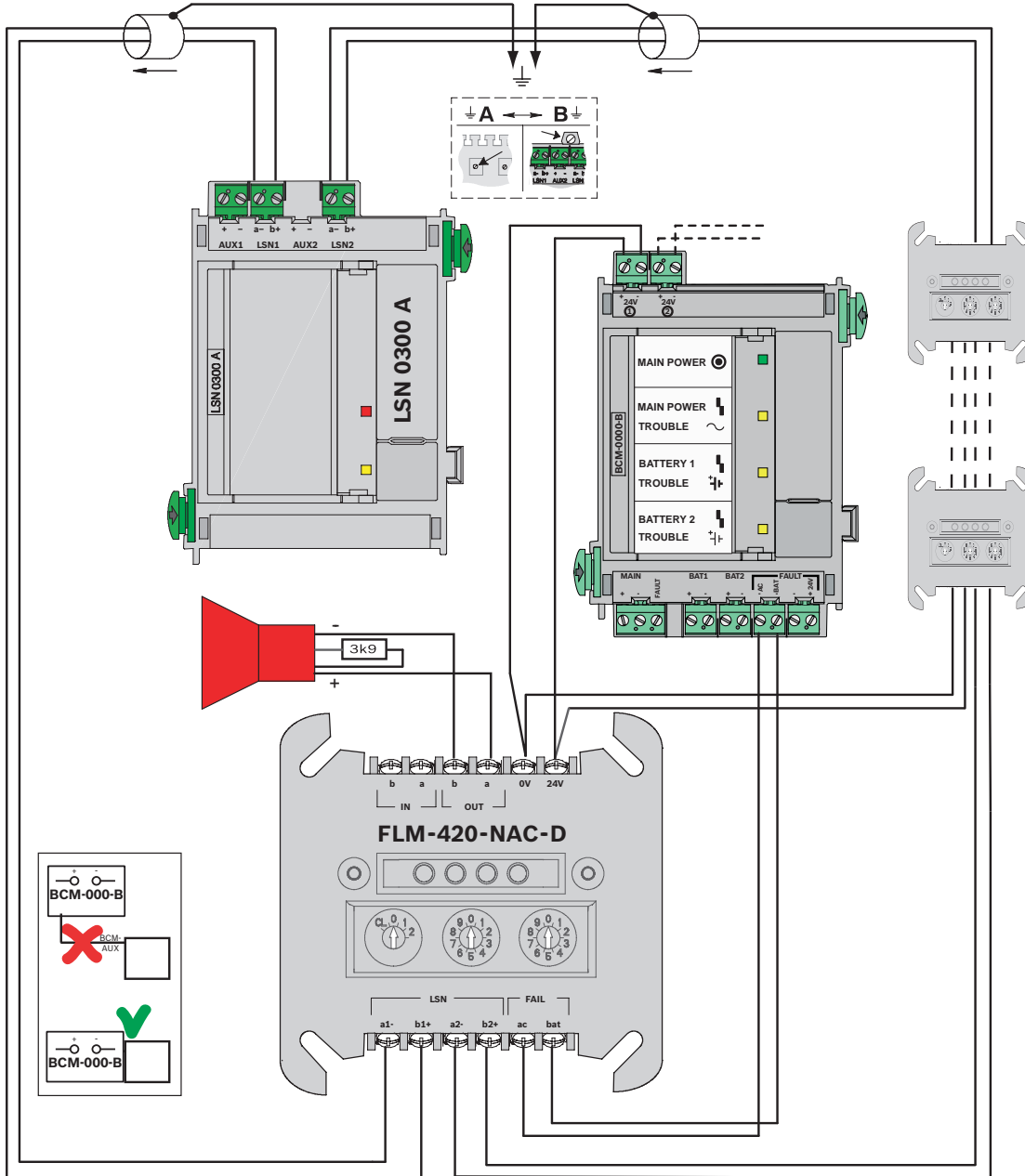
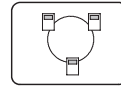

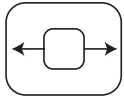

FLM-420-RLE-S

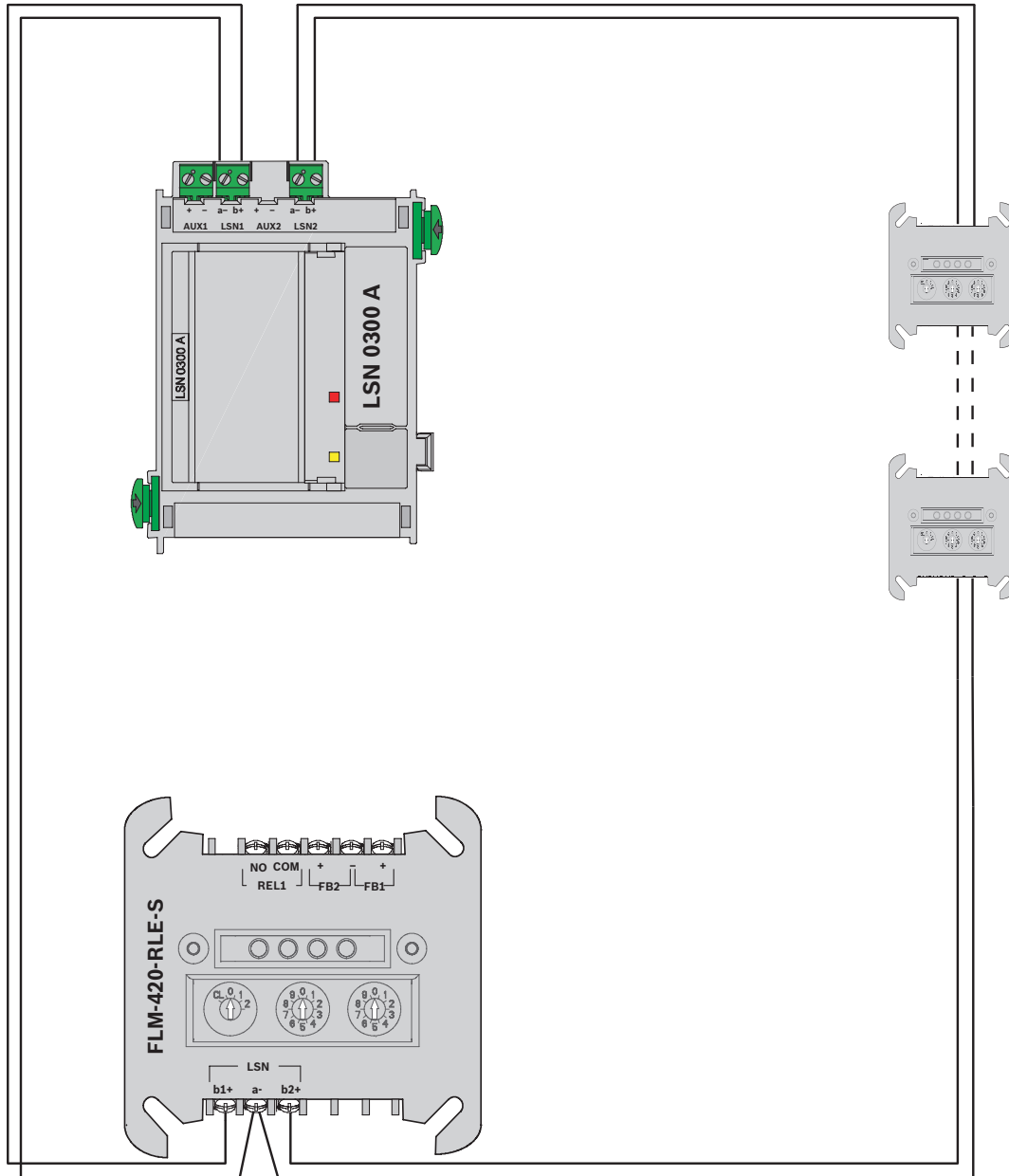
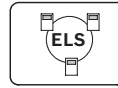

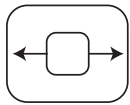

FLM-420-O111-D

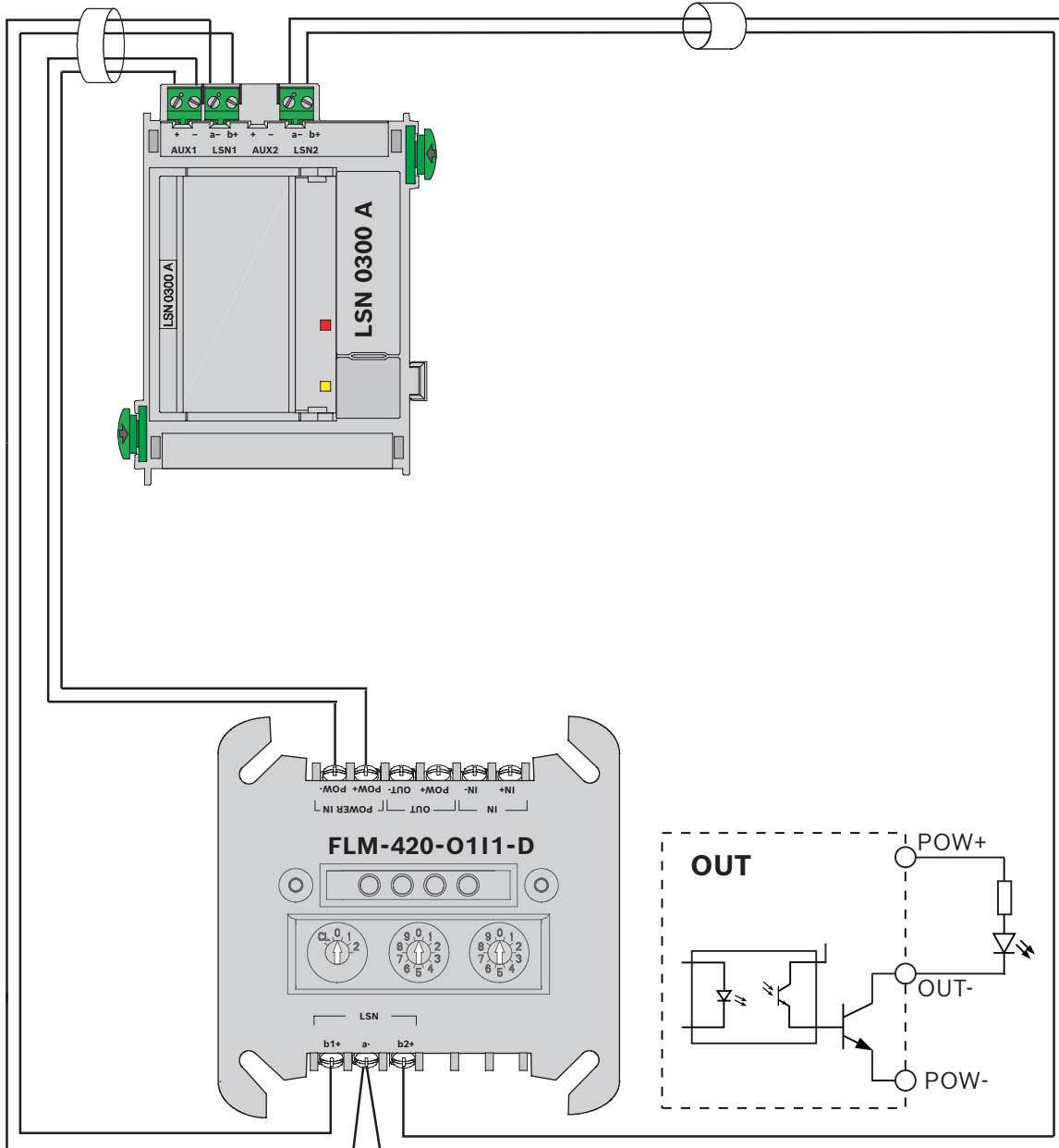
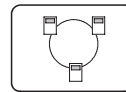

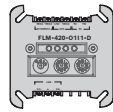
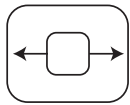

FLM-420-O111-D

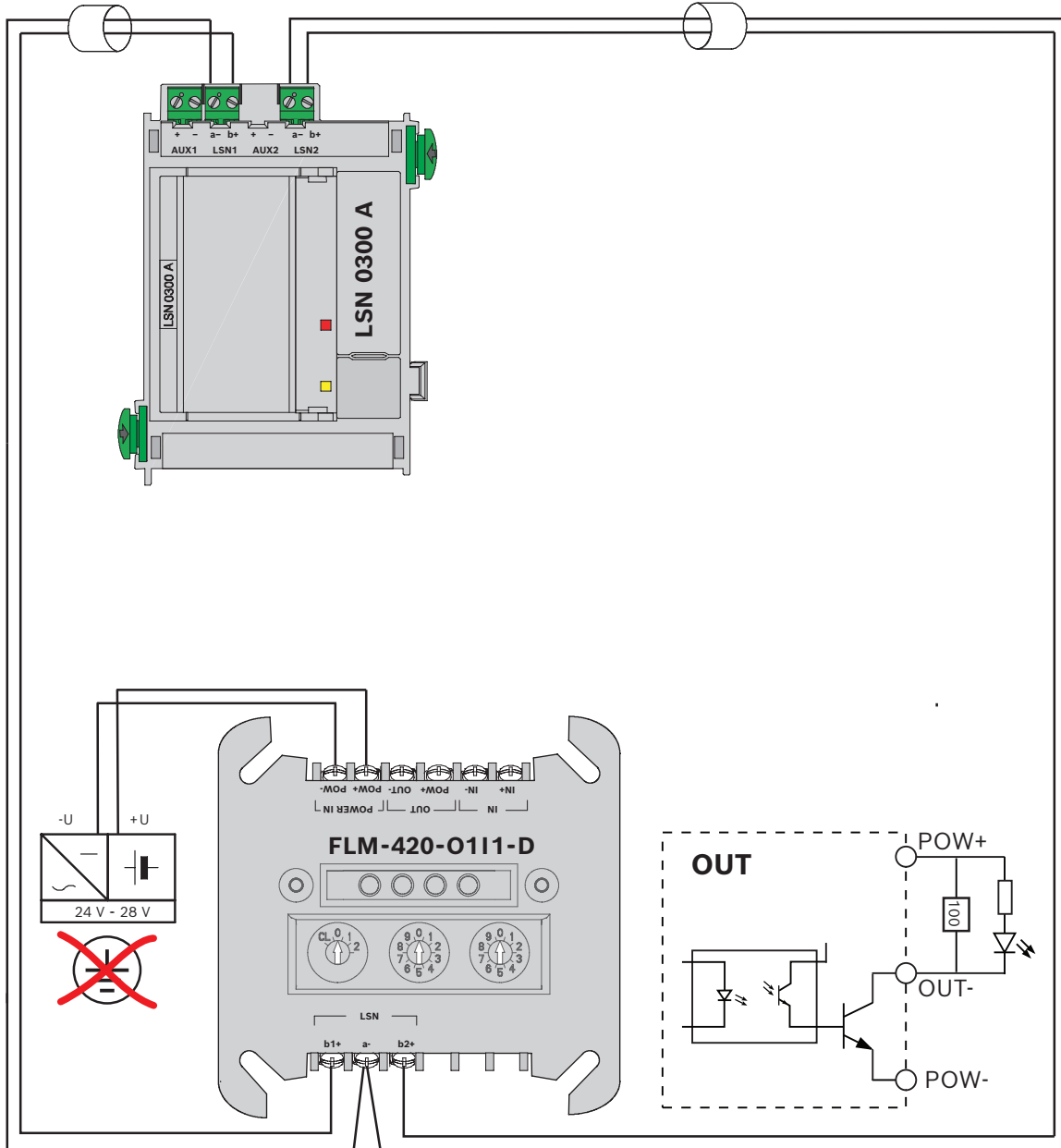
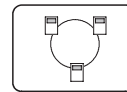

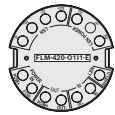
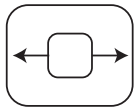

FLM-420-O111-E

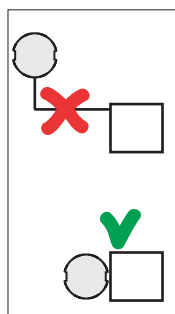
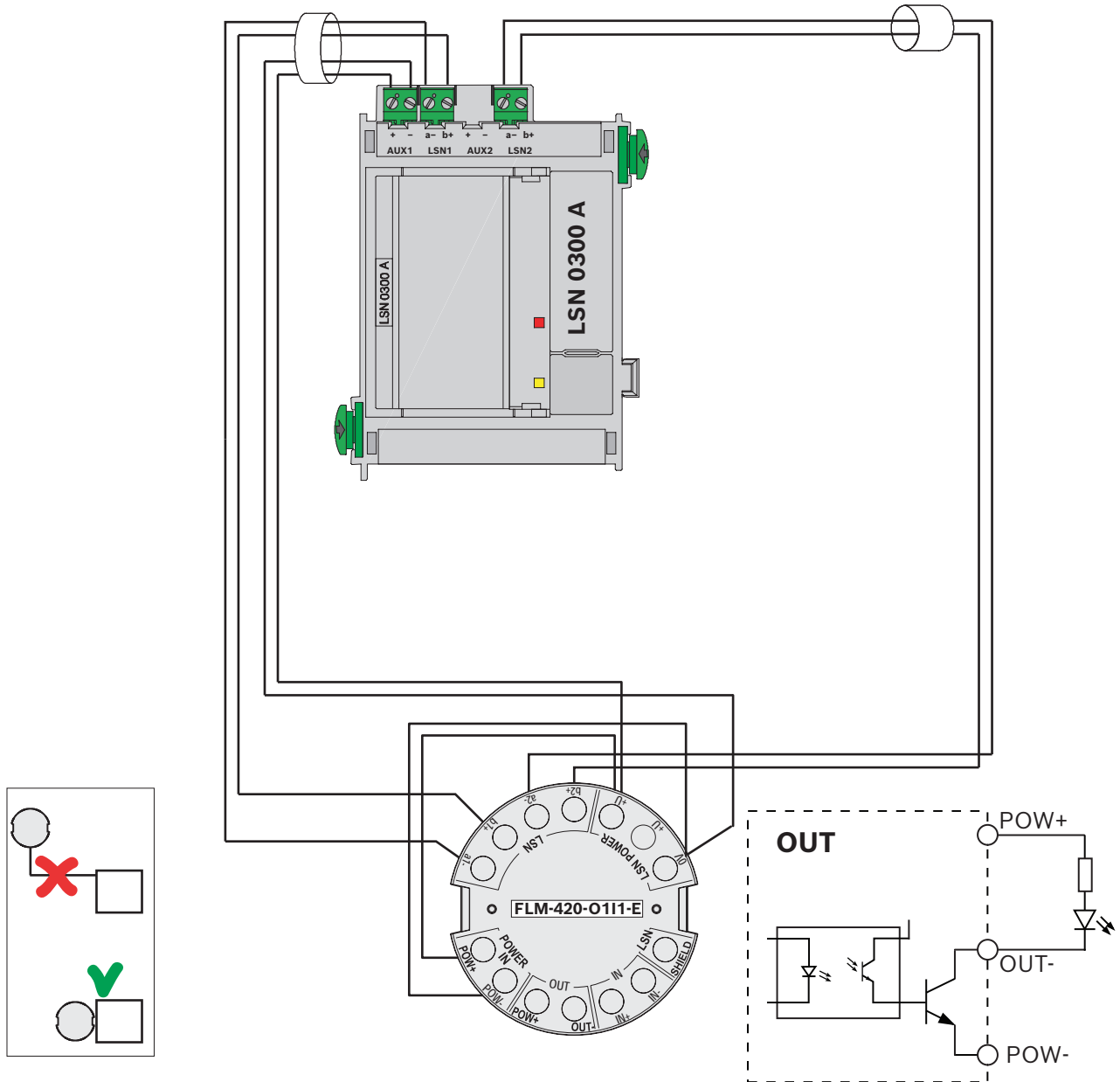
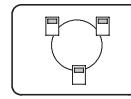

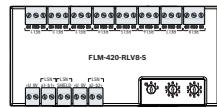
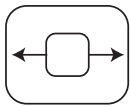

FLM-420-RLV8-S

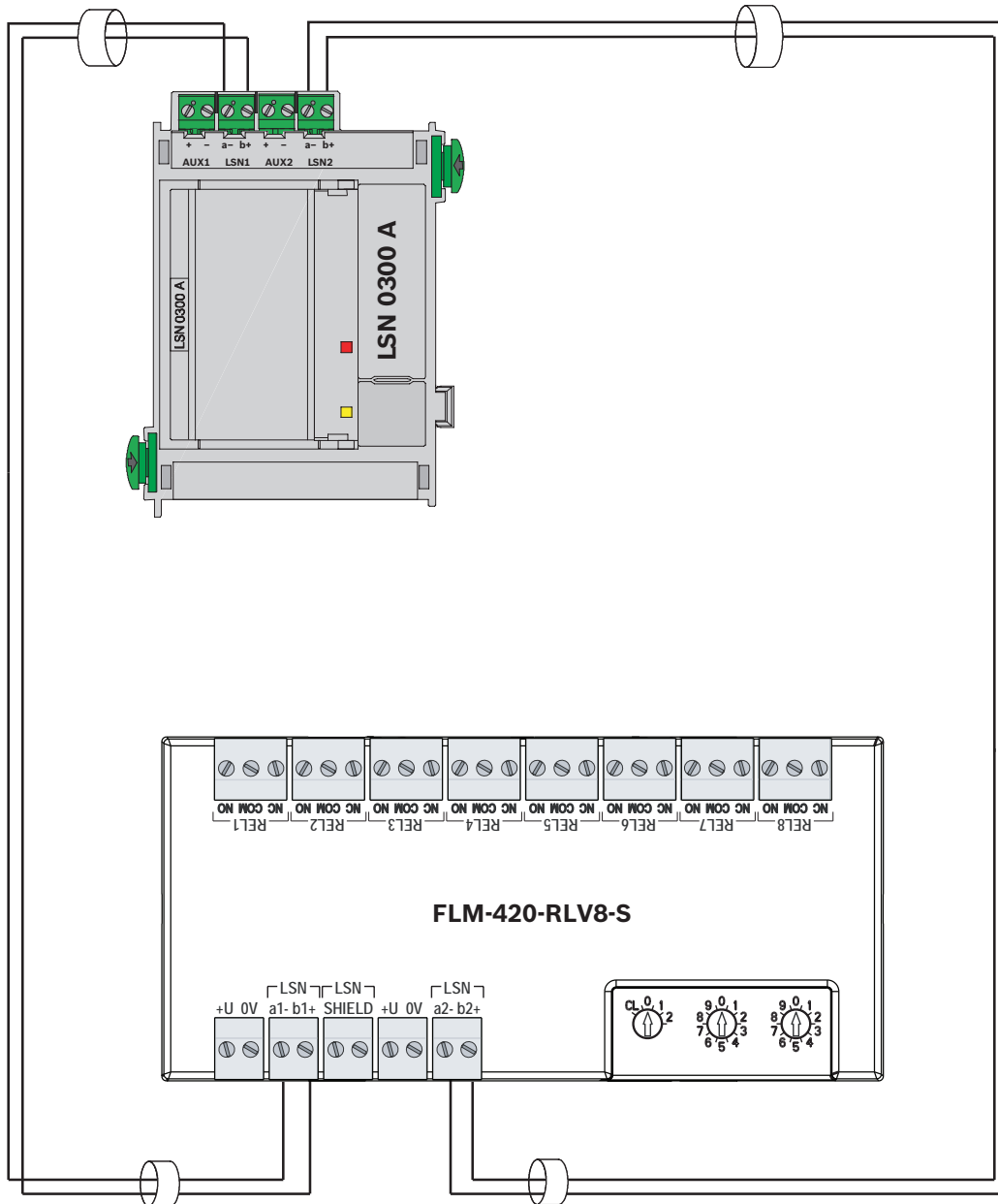
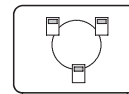



FAD-0420

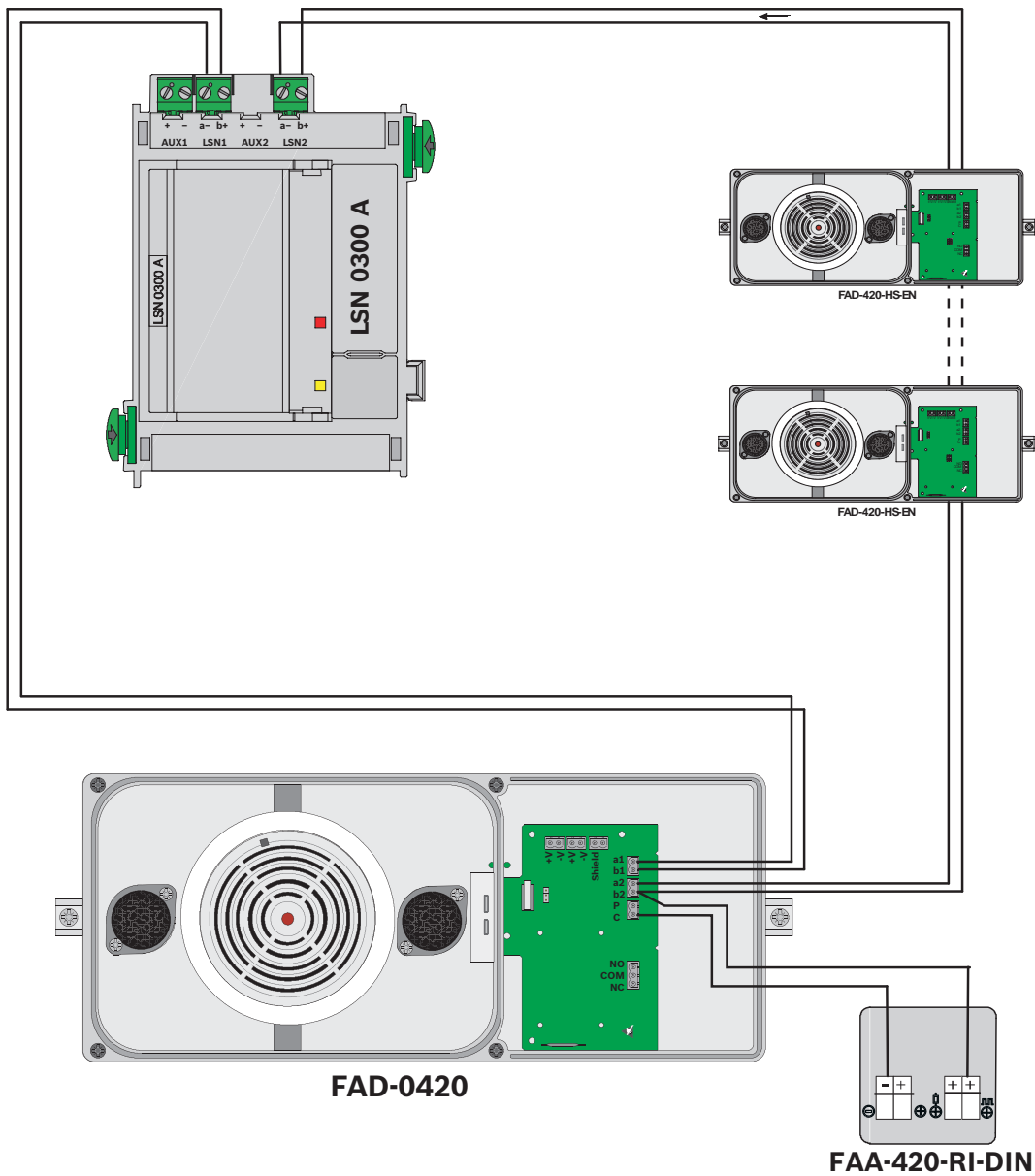



FAD-420-HS-EN

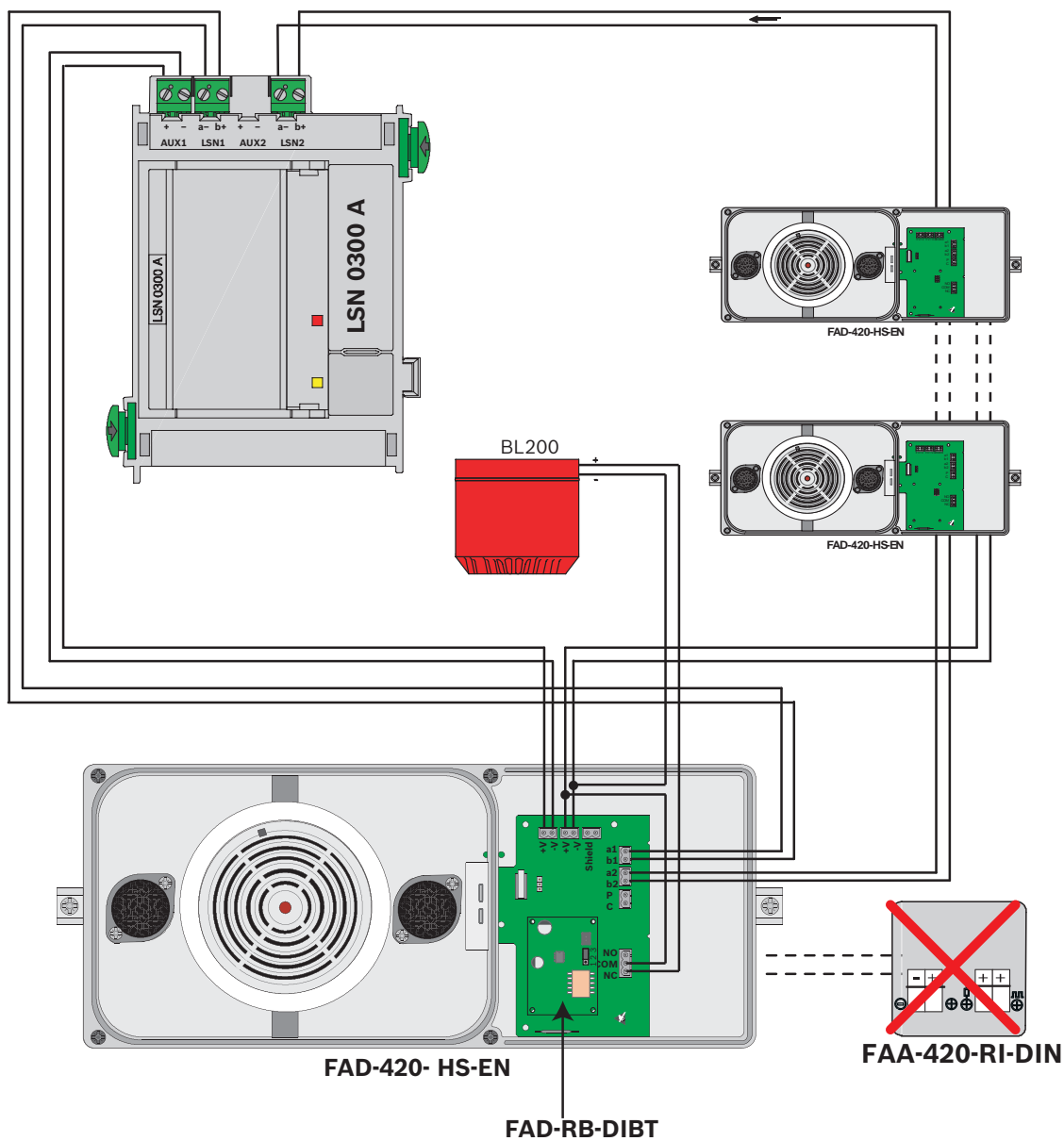

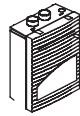

FAS-420 Series

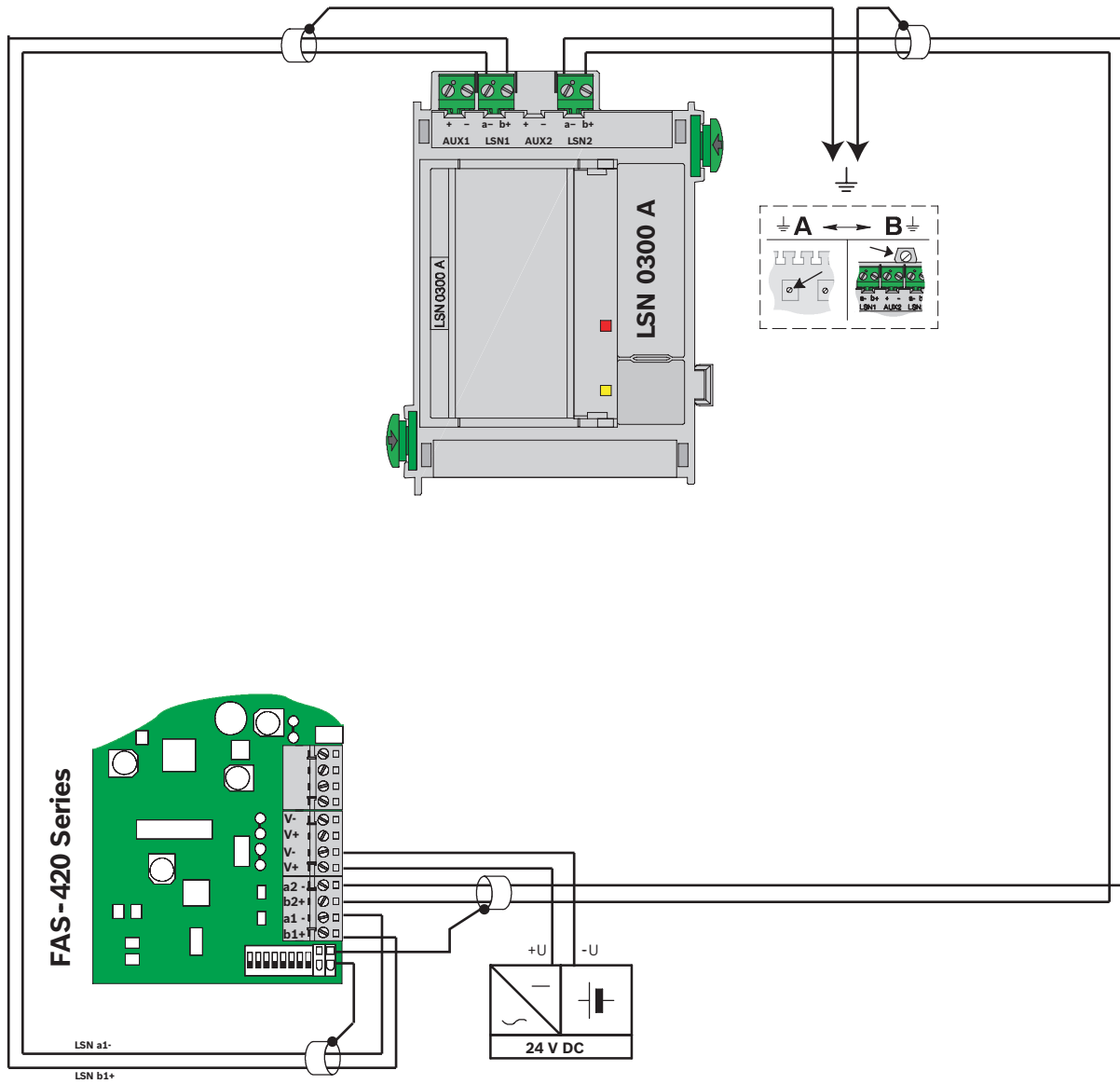

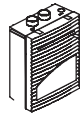

FAS-420-TM Series

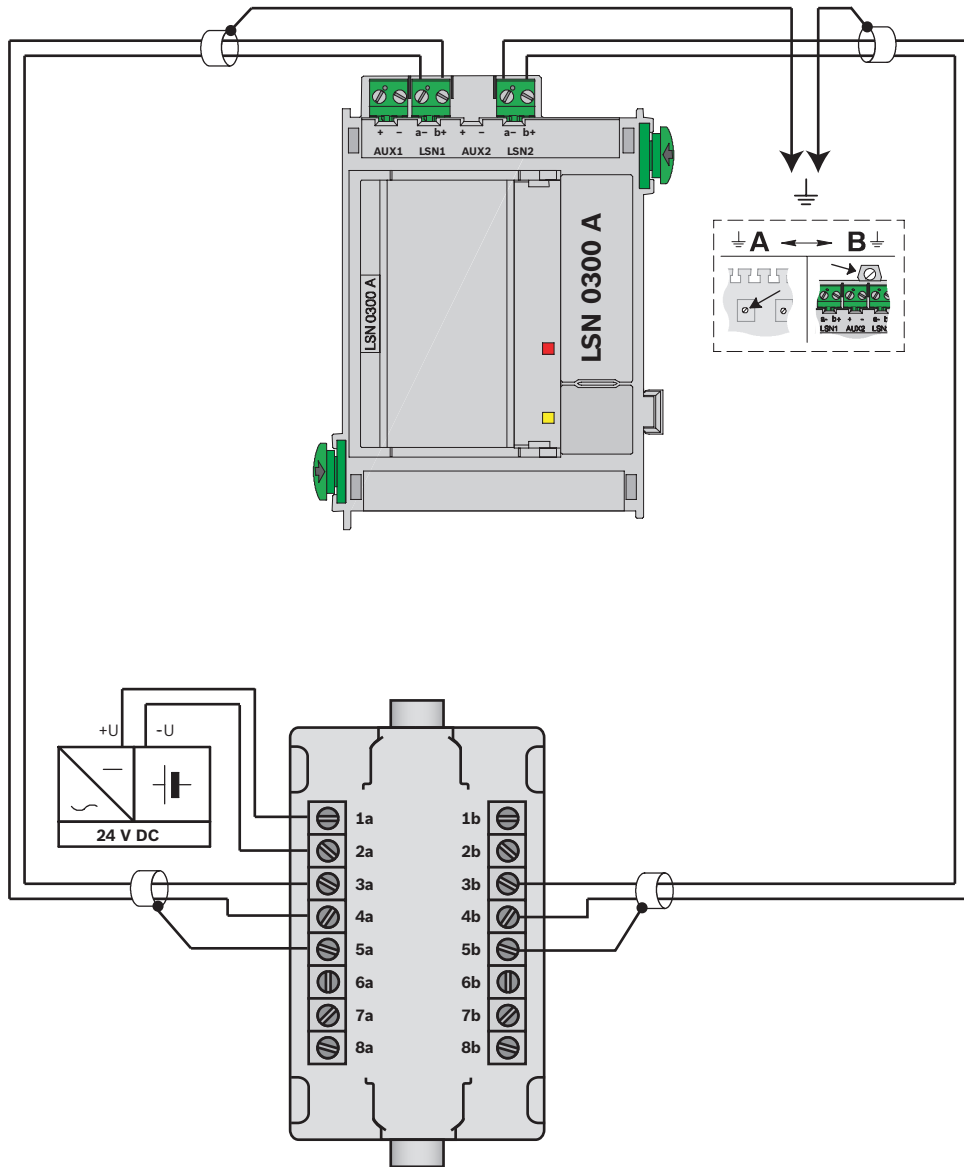

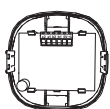

FNM-420-A / -B
FNM-420U-A / -B
FNM-420V-A

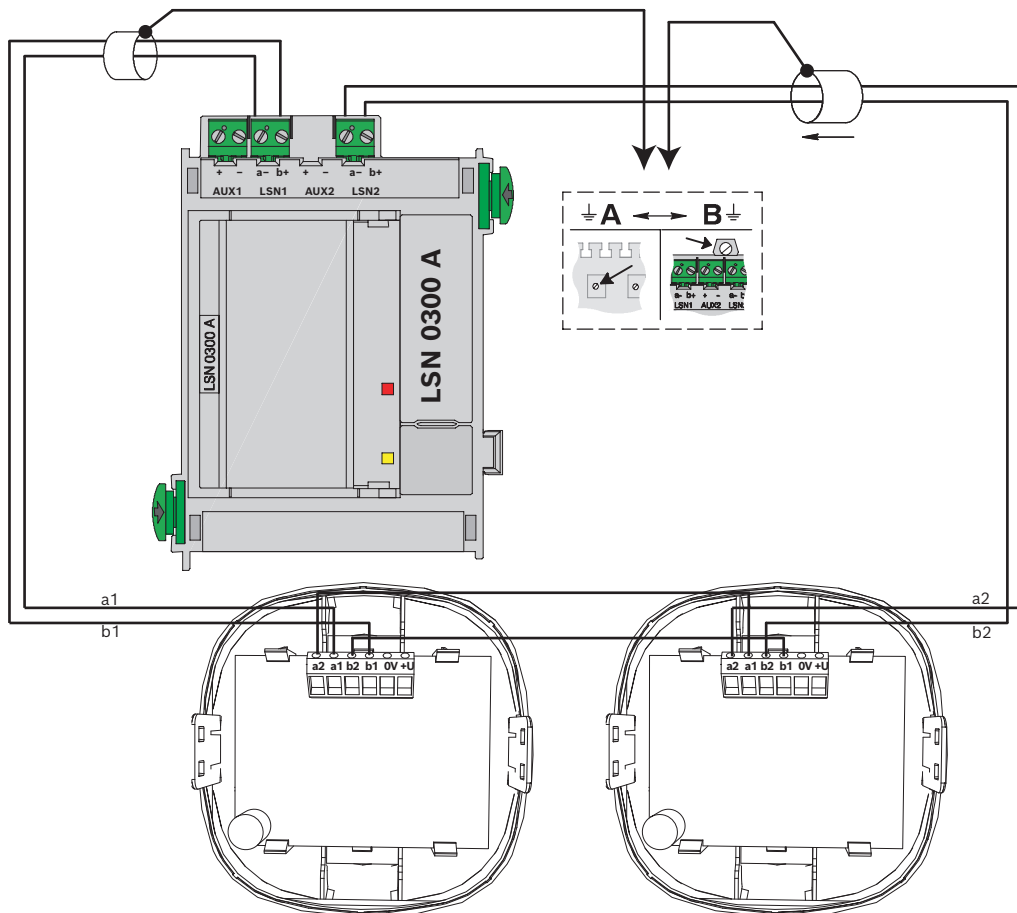
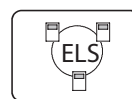

FNM-420-A/-B
FNM-420U-A/-B
FNM-420V-A

FNM-420-A/-B
FNM-420U-A/B
FNM-420V-A



FNM-420-A-BS
FNM-420U-A-BS

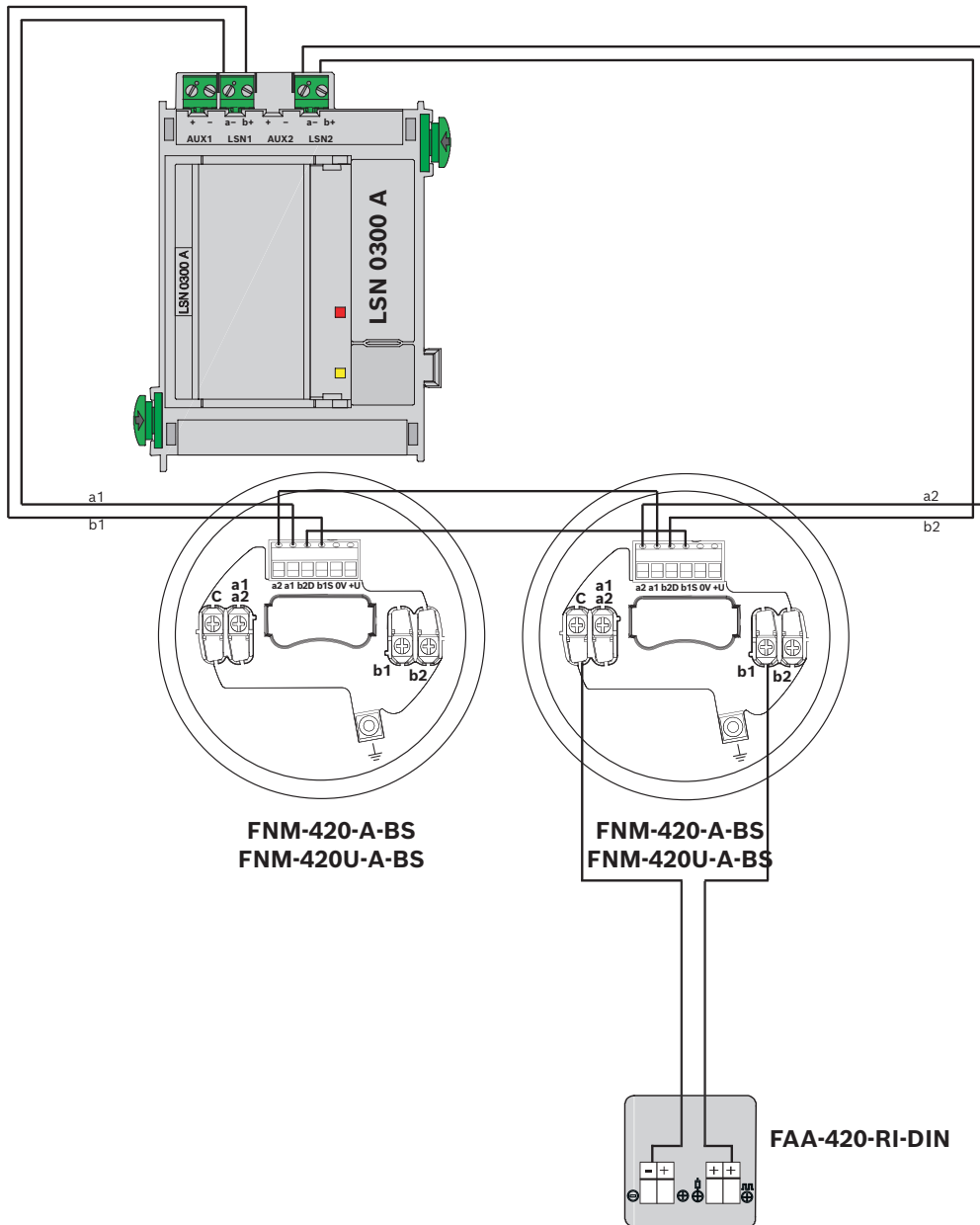
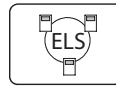

FNM-420-A-BS
FNM-420U-A-BS

FNM-420-A-BS
FNM-420U-A-BS

FAA-420-RI-DIN



FNM-420-A-BS
FNM-420U-A-BS

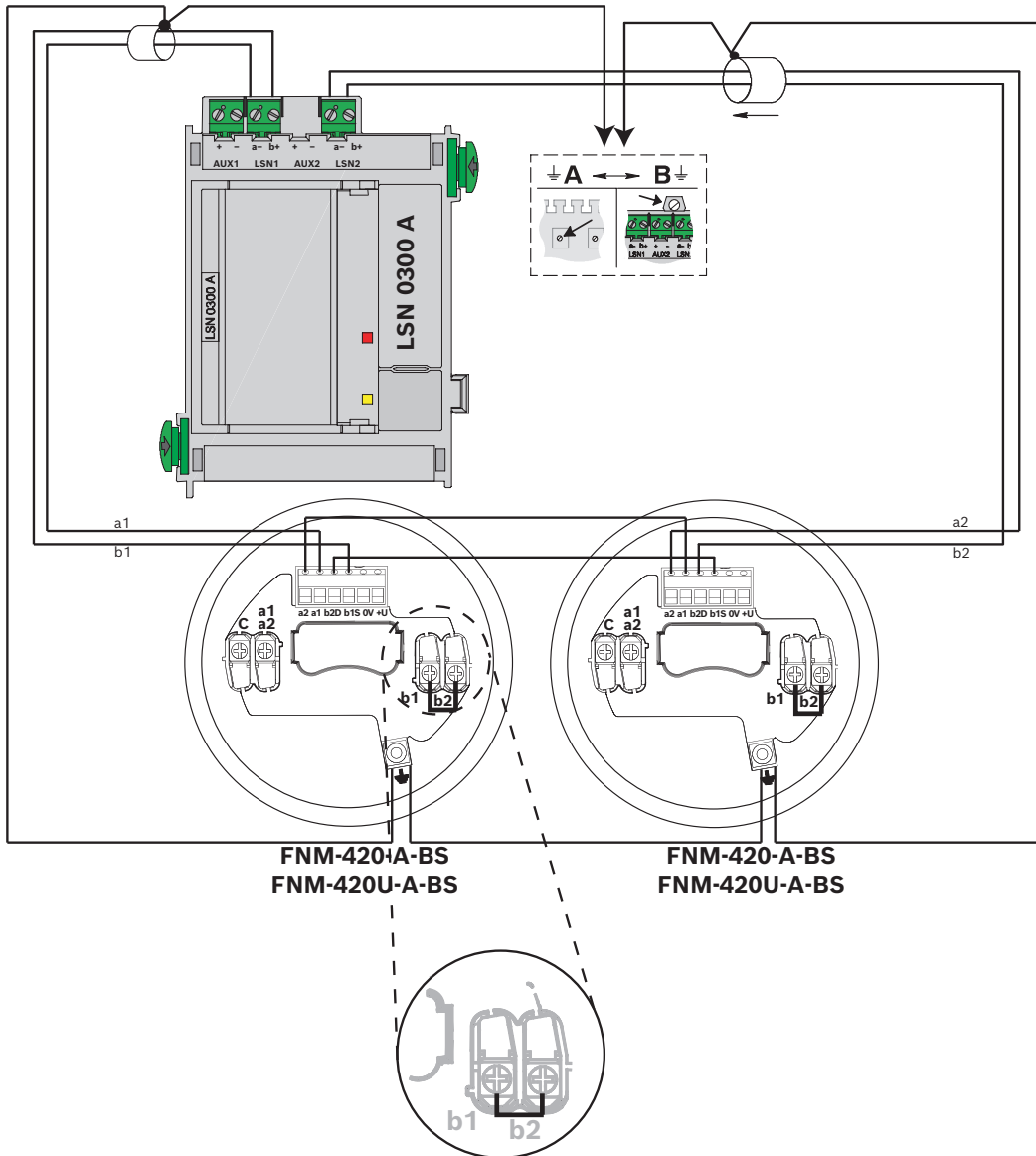
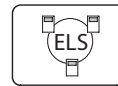

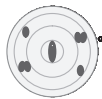

FAP-0520
FAP-0520-P
FAP-OC520
FAP-OC-520-P

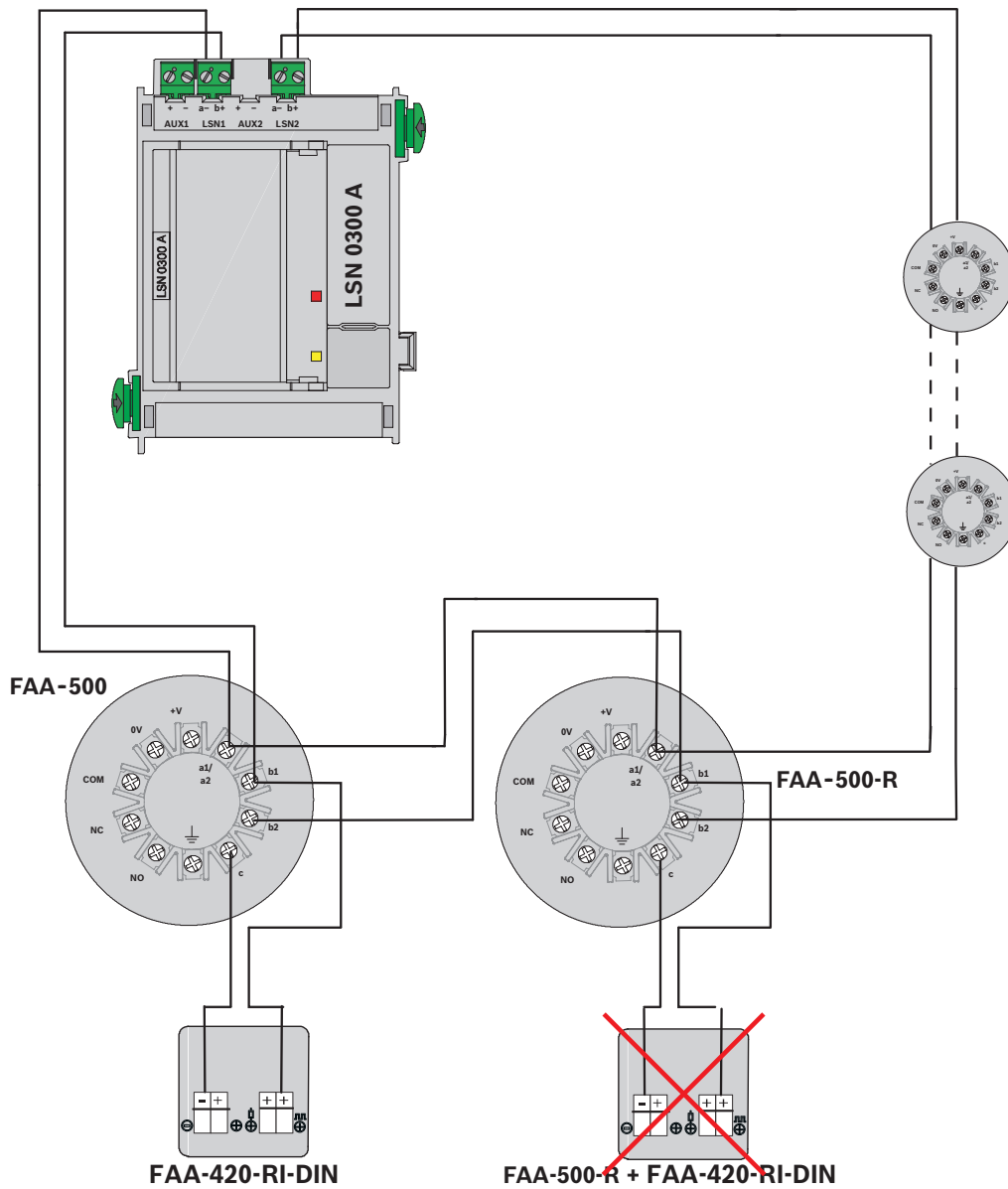
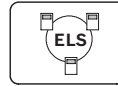

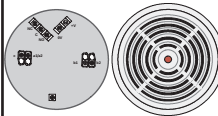

FAA-MSR-420
FAP-425-O, FAP-425-O-R
FAP-425-OT, FAP-425-OT-R
FAP-425-T-R
FAP-425-DO-R, FAP-425-DOT-R
FAP-425-DOTC-R, FAP-425-DOTCO-R

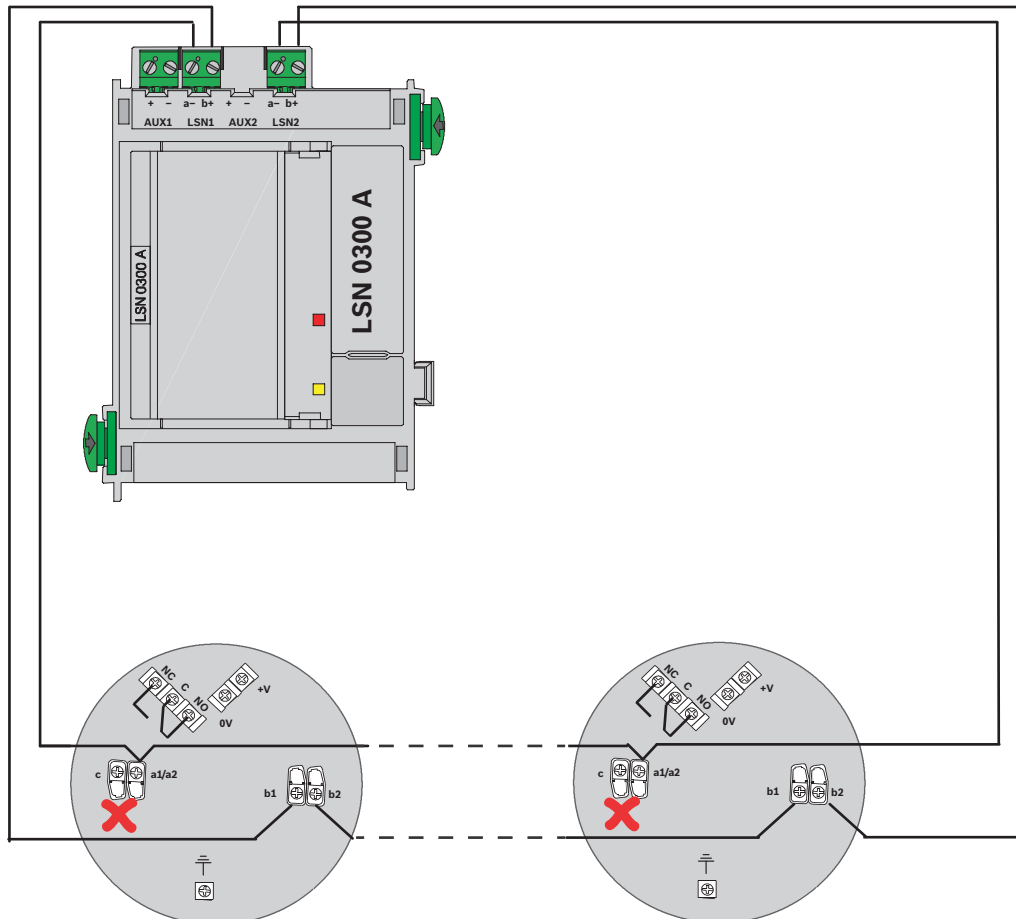
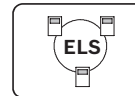

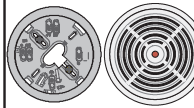

MS 400, MS 400 B
 FAP-425-O, FAP-425-O-R
 FAP-425-OT, FAP-425-OT-R
 FAP-425-T-R
 FAP-425-DO-R, FAP-425-DOT-R
 FAP-425-DOTC-R, FAP-425-DOTCO-R

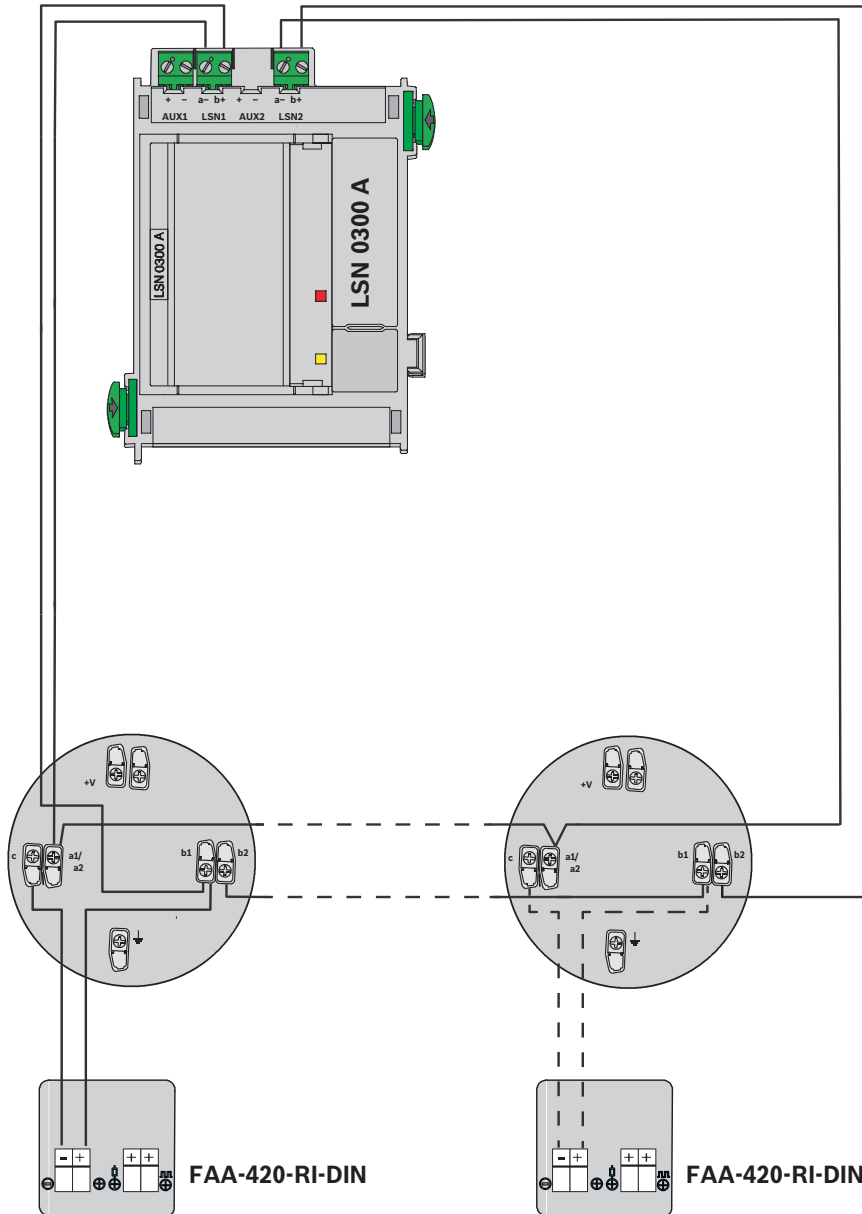
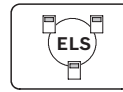

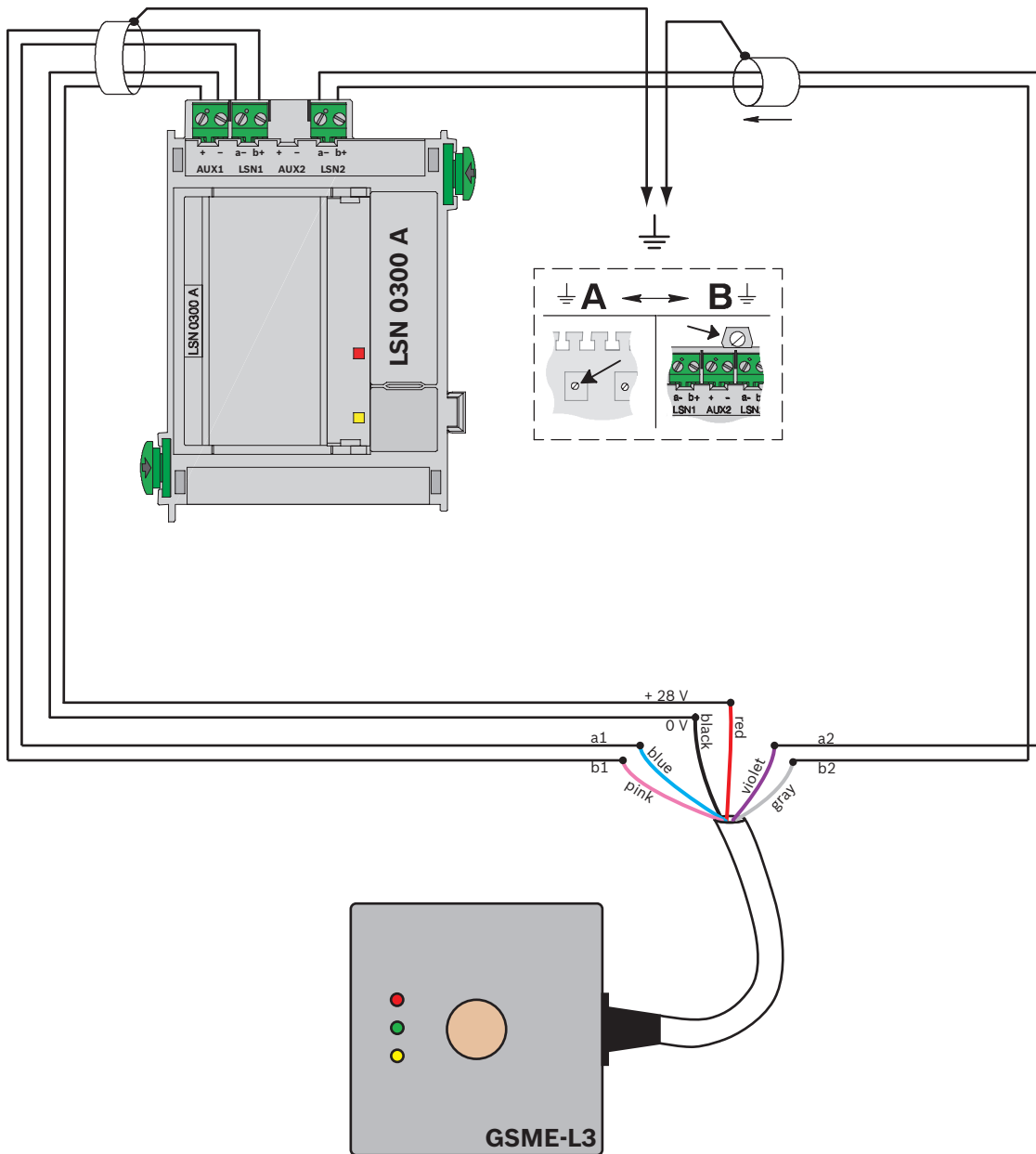
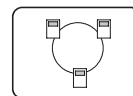

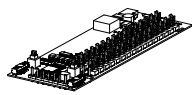

ATB 420 LSNi

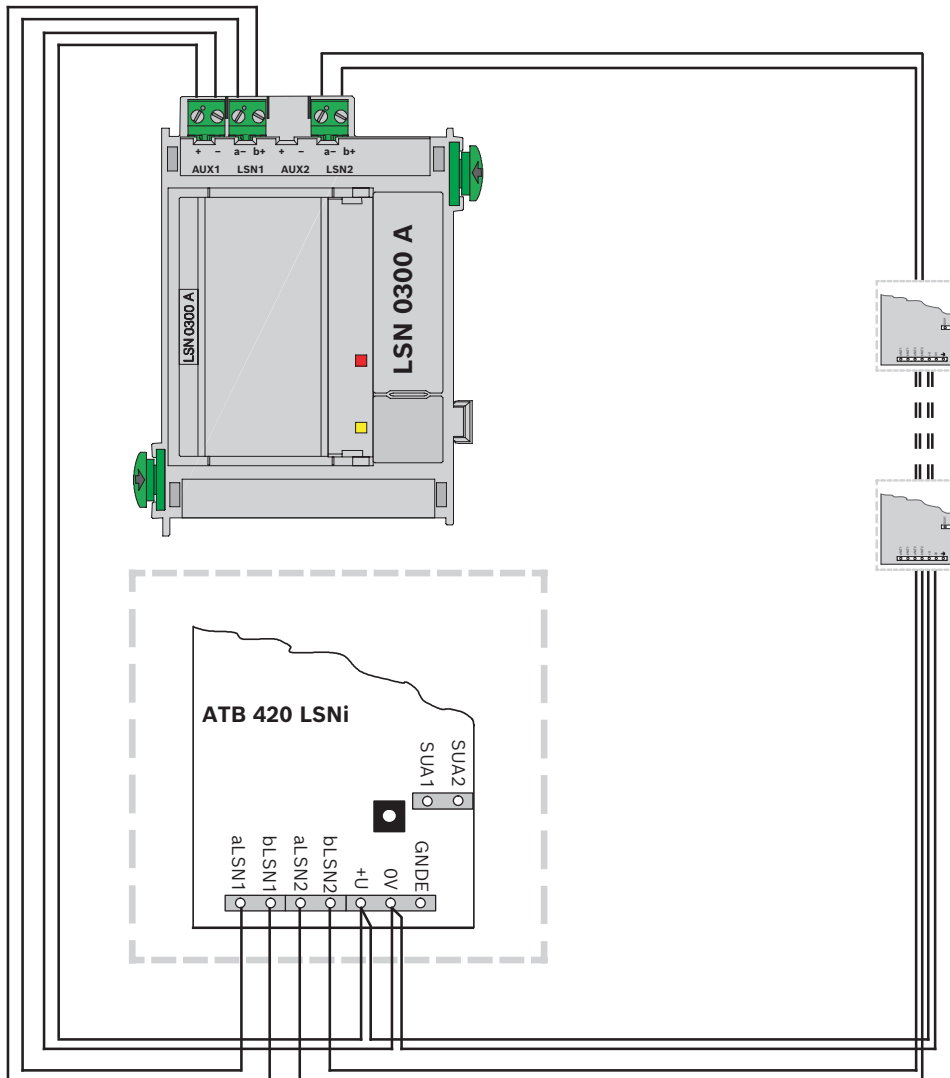
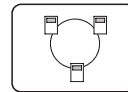



BAT 100 LSN
ATG 420 LSNi

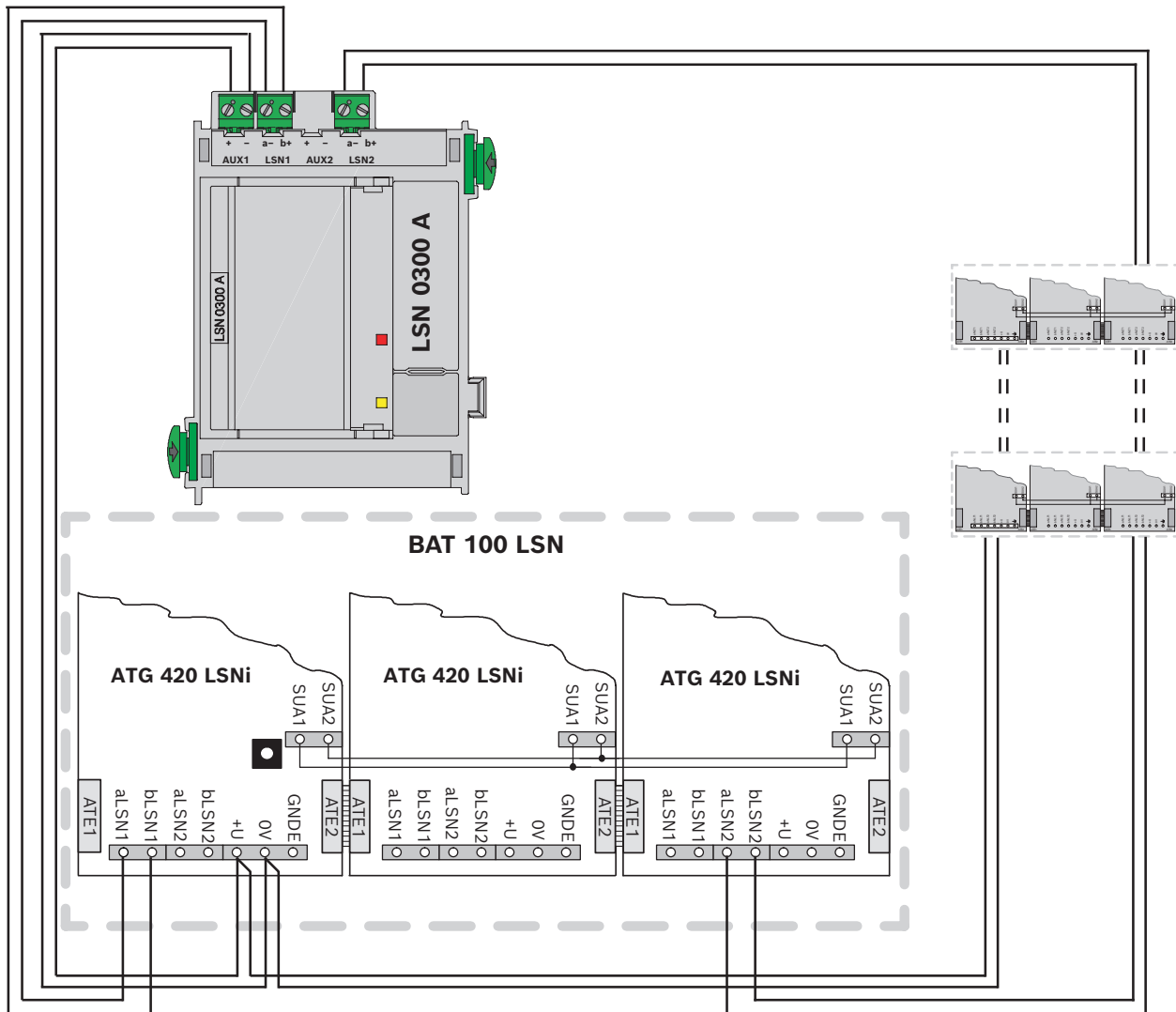
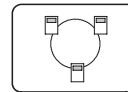

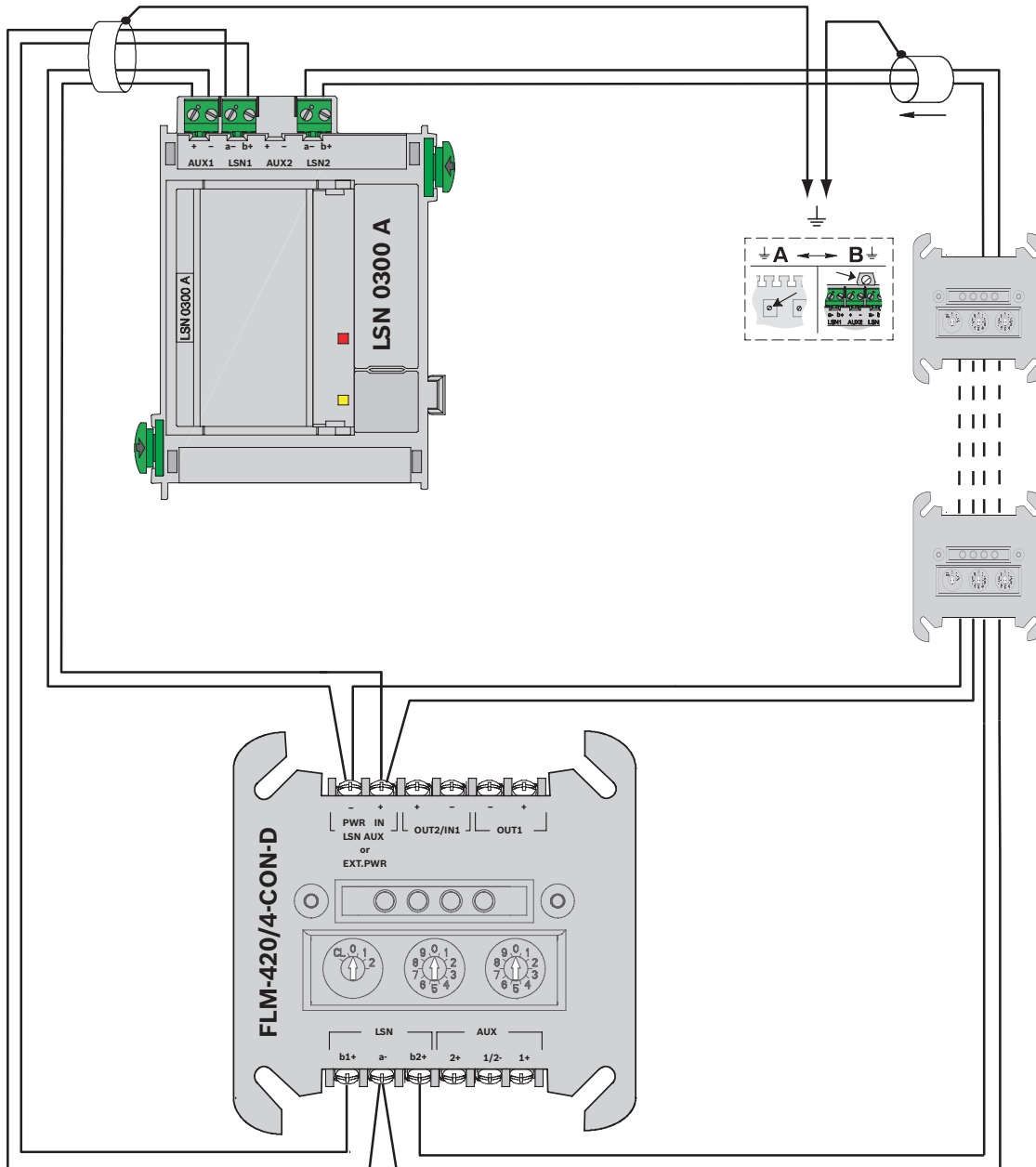
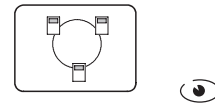
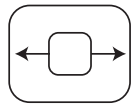



FBF 100 LSN

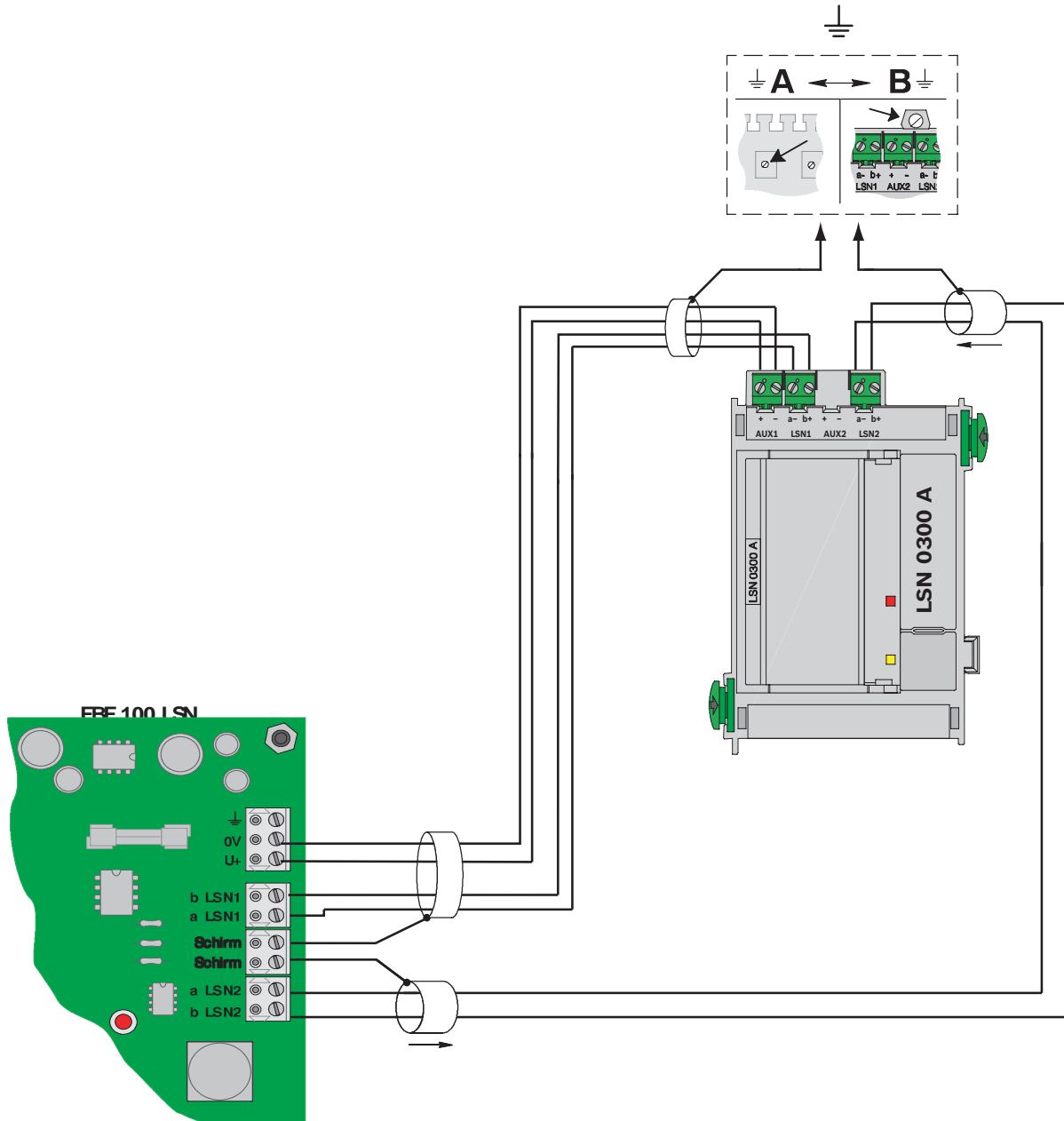
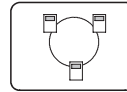

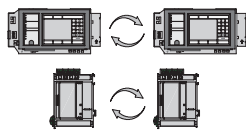

FLM-420-RLE-S

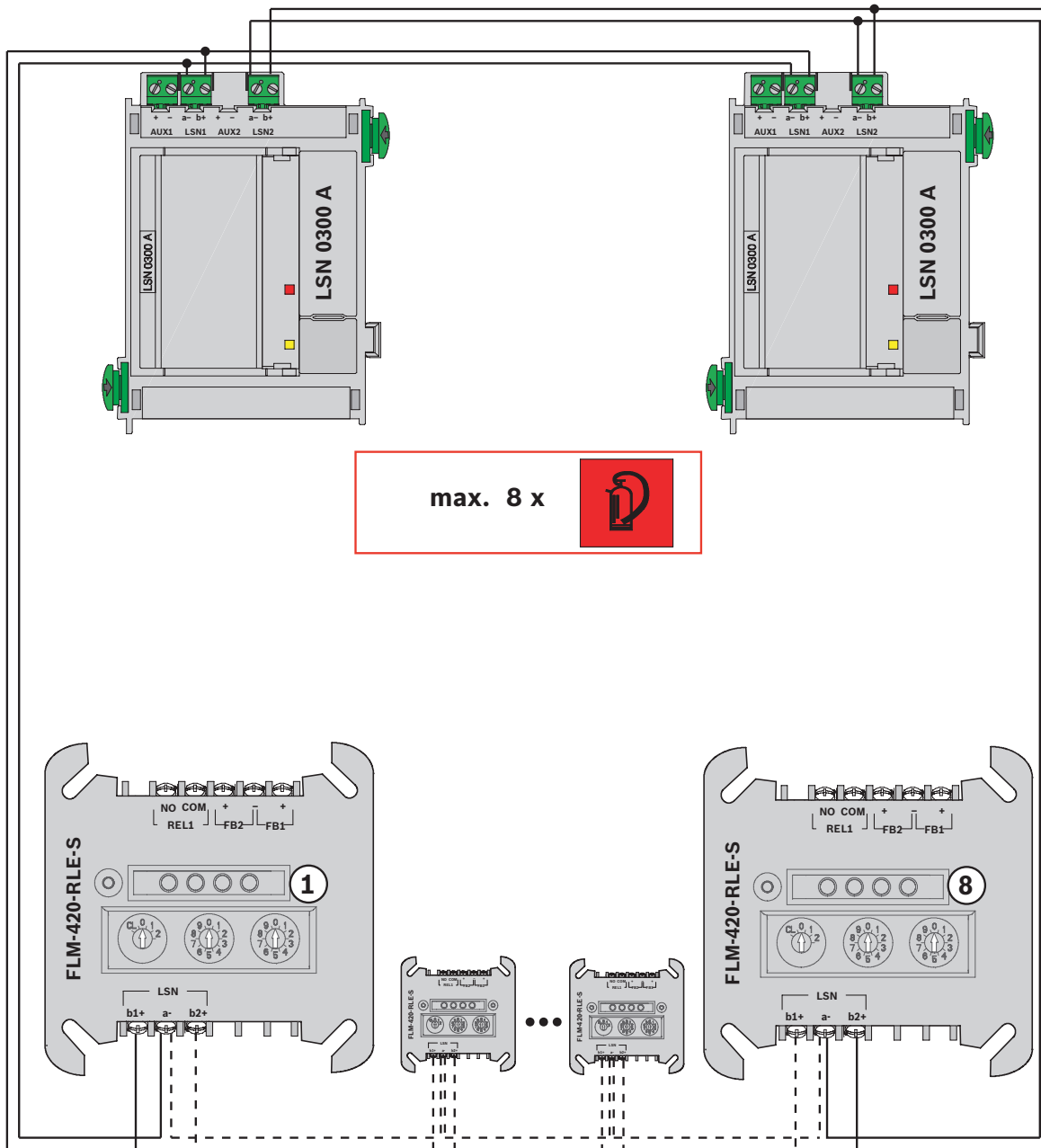
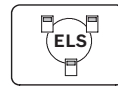



FNX-425U-WFWH
FNX-425U-RFWH
FNX-425U-WFRD
FNX-425U-RFRD

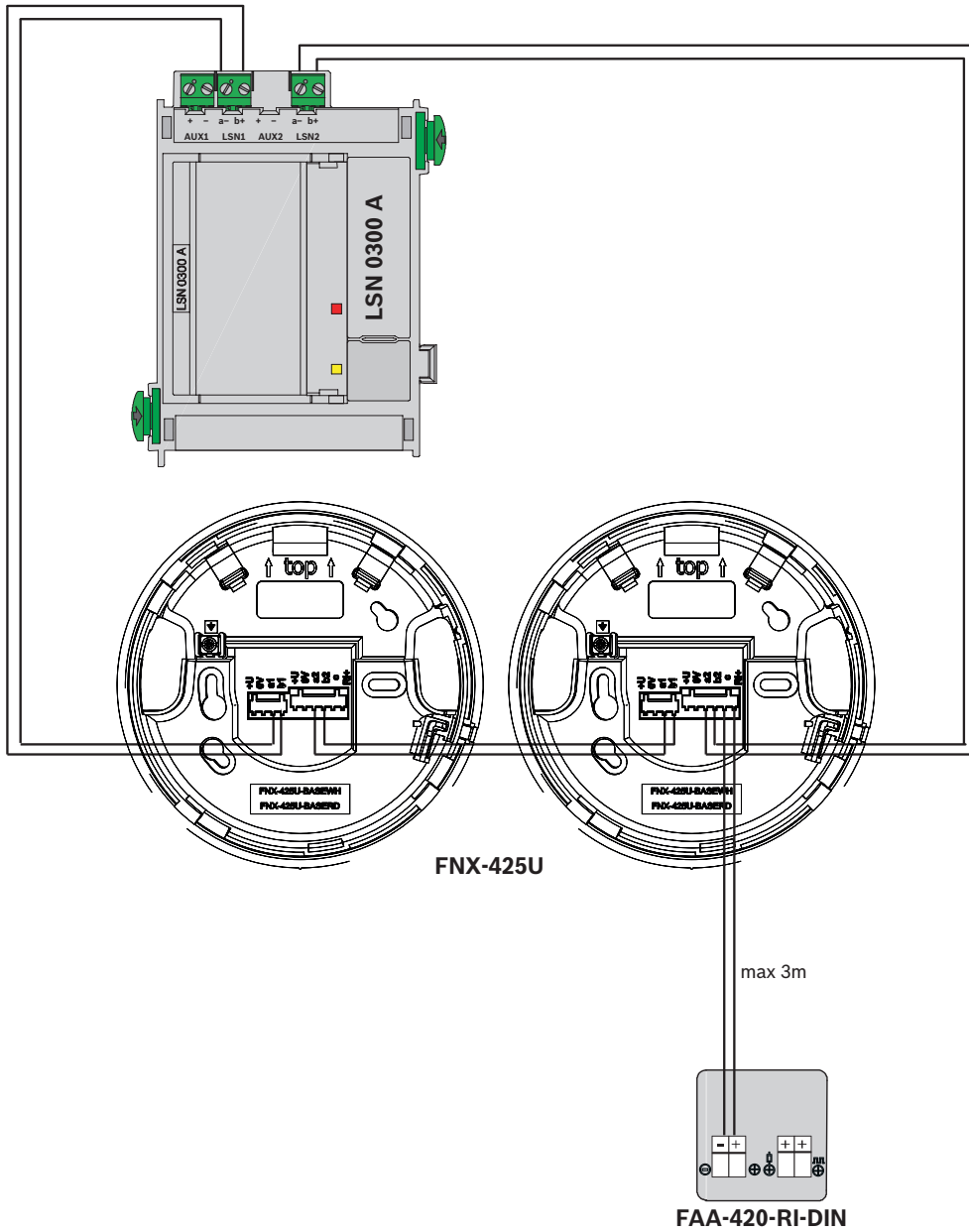
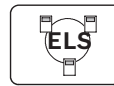



FNX-425U-WFWH
 FNX-425U-RFWH
 FNX-425U-WFRD
 FNX-425U-RFRD

+ FNX-425U-COVWH
 + FNX-425U-COVRD

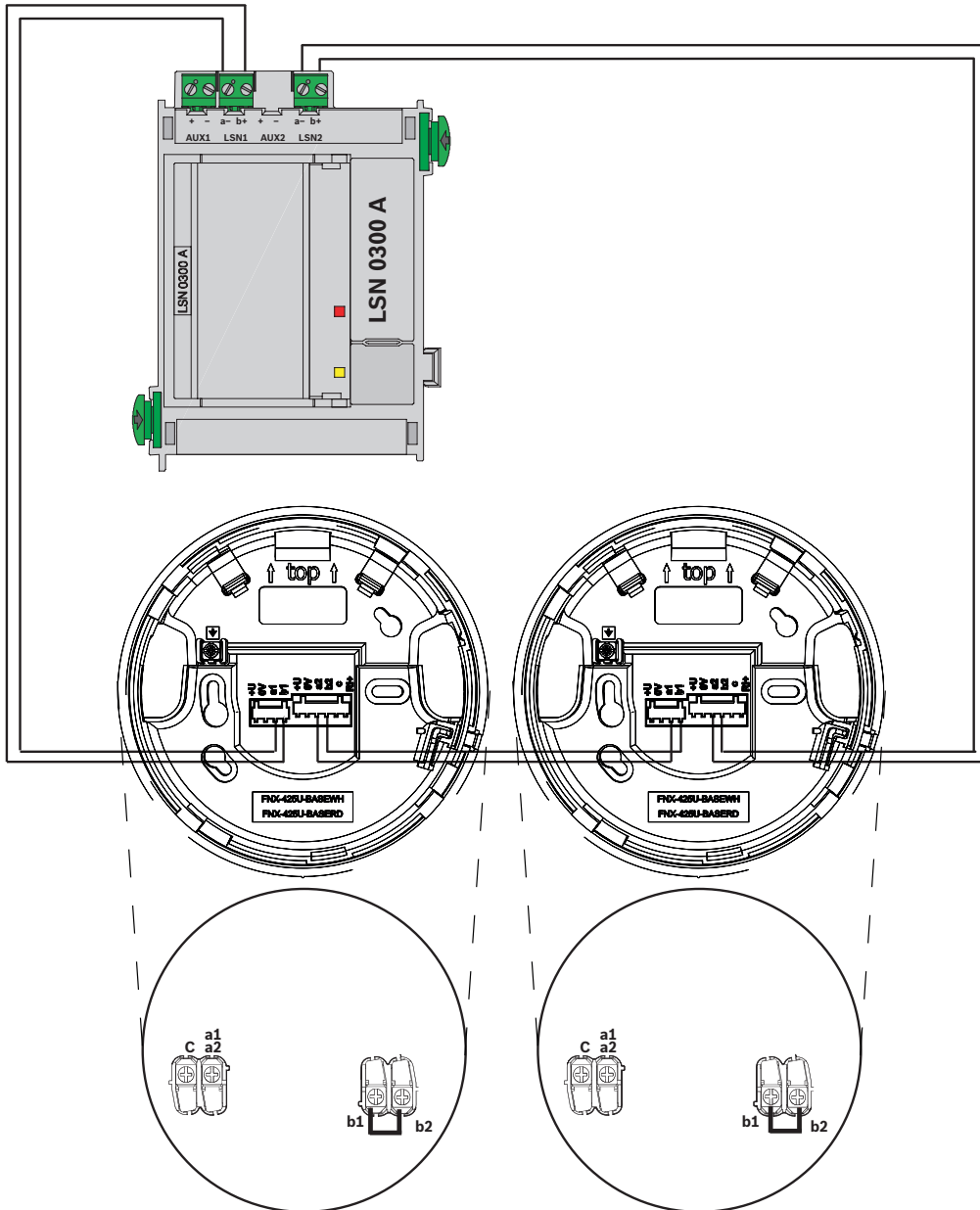
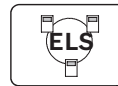

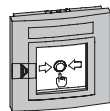
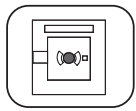

FMC-210...

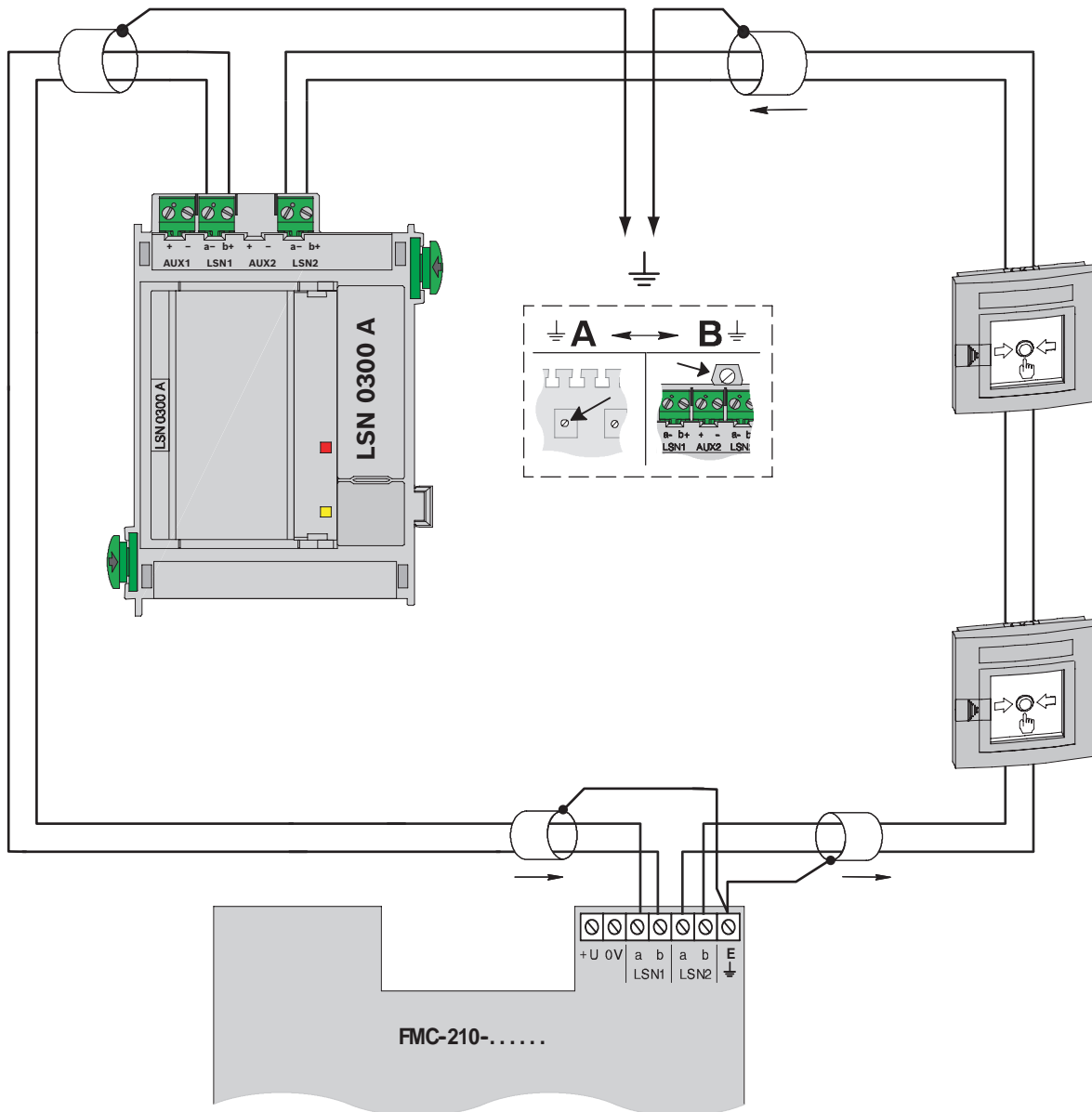
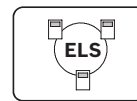

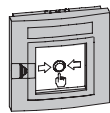
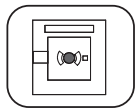

FMC-210-IP66-R

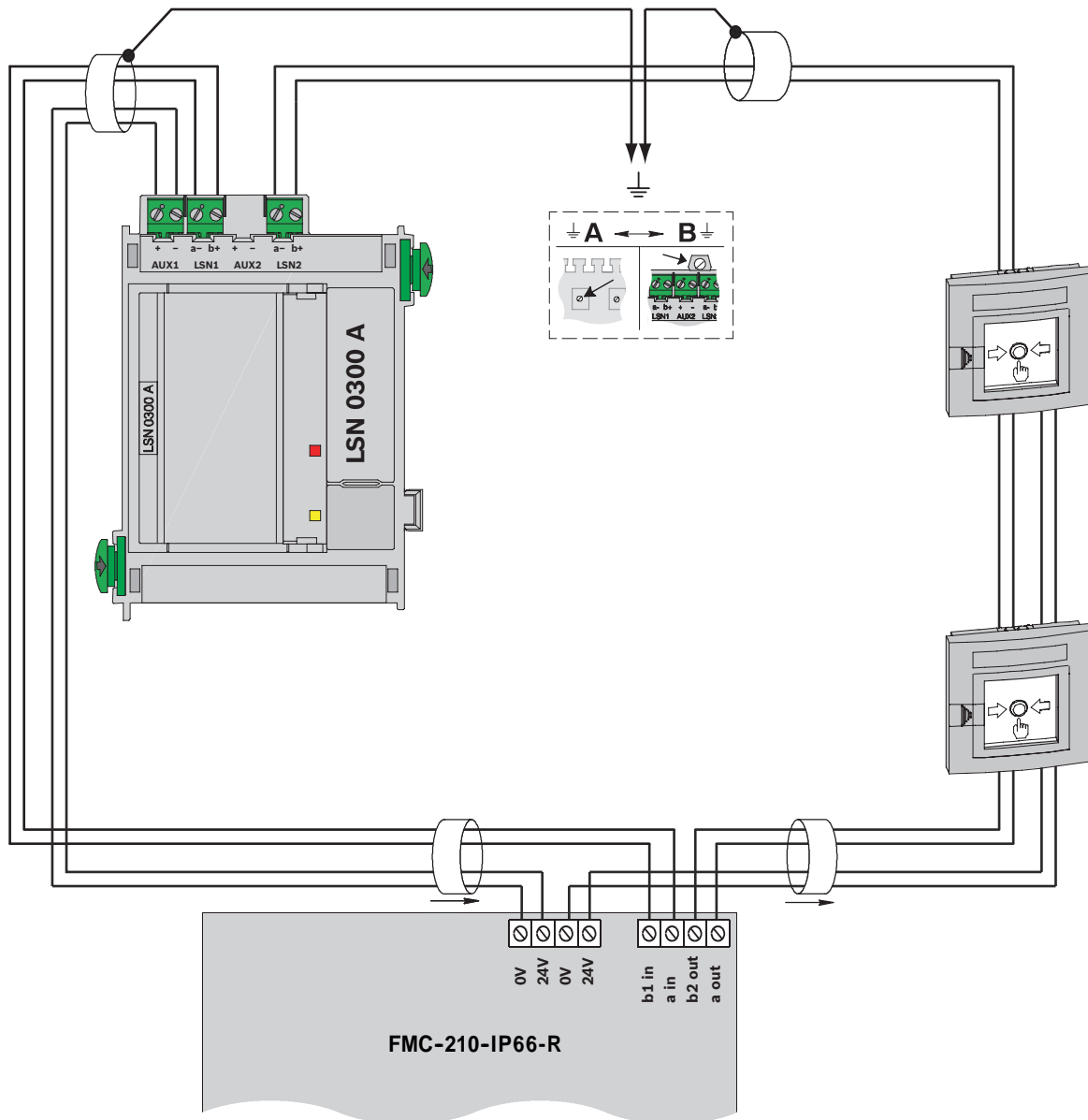
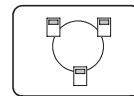

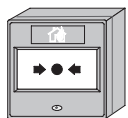
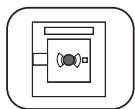

FMC-420RW-HSGRD
 FMC-420RW-HSRRD
 FMC-420RW-GFGRD
 FMC-420RW-GFRRD
 FMC-420RW-GSGRD
 FMC-420RW-GSRRD

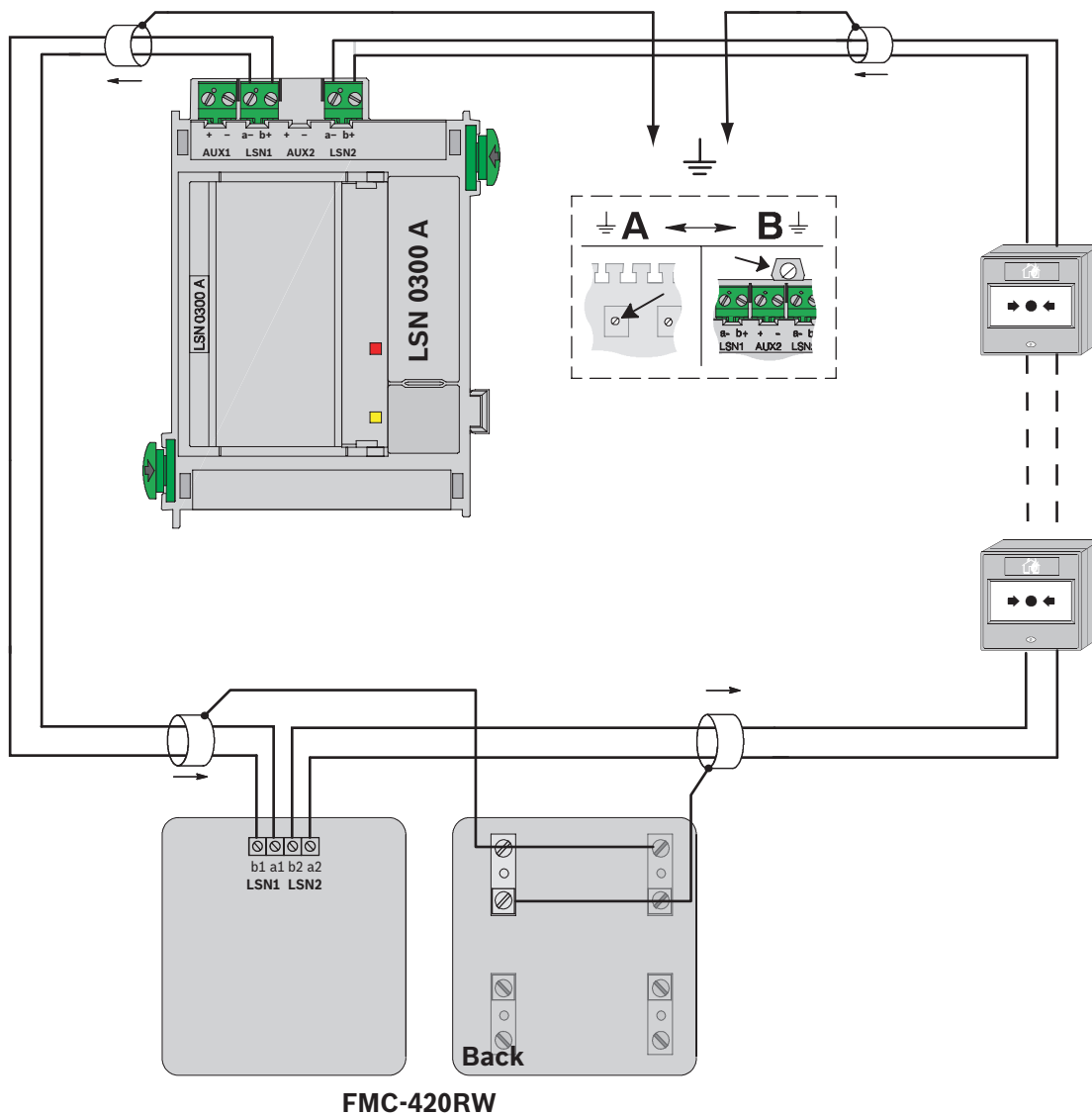
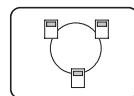

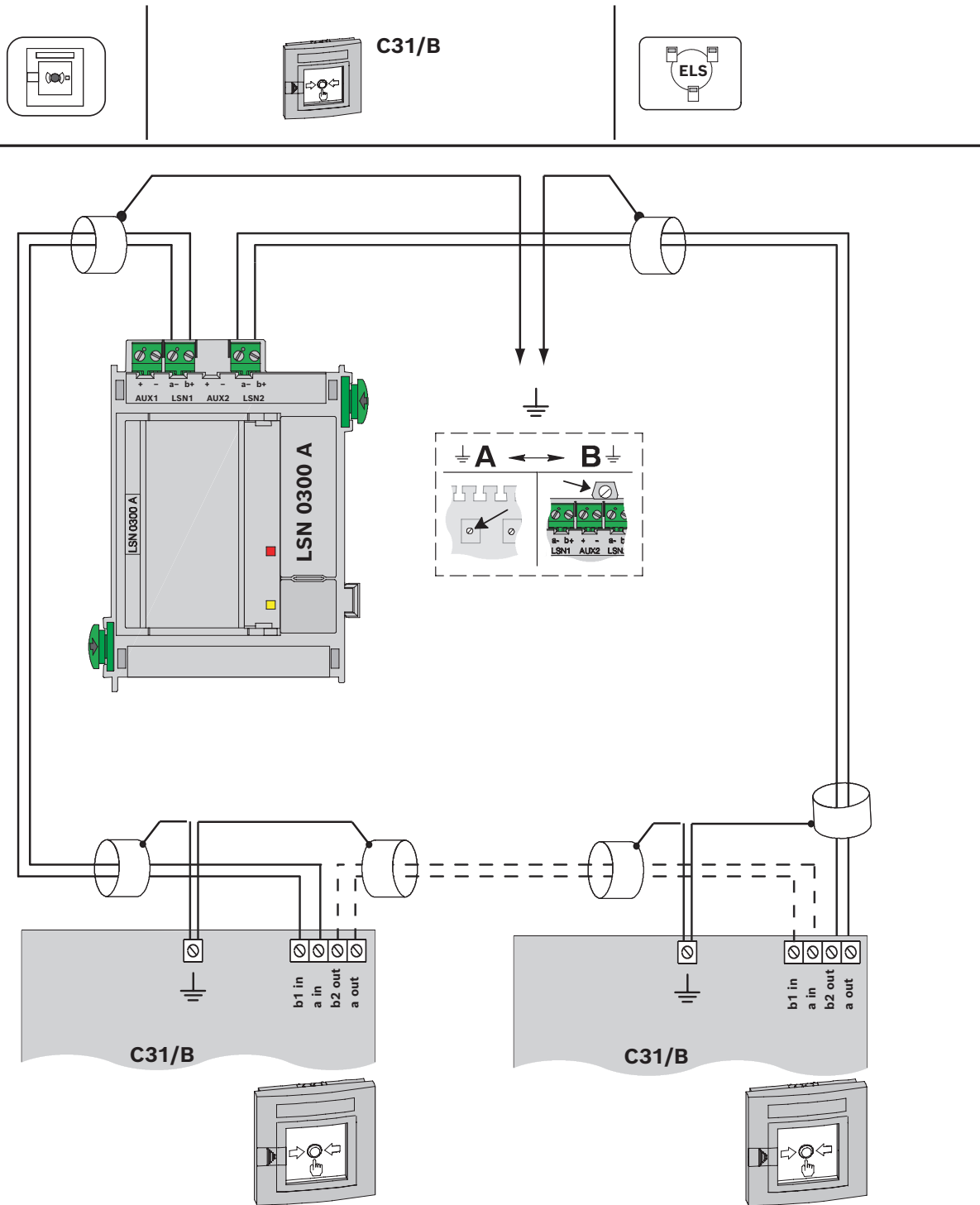

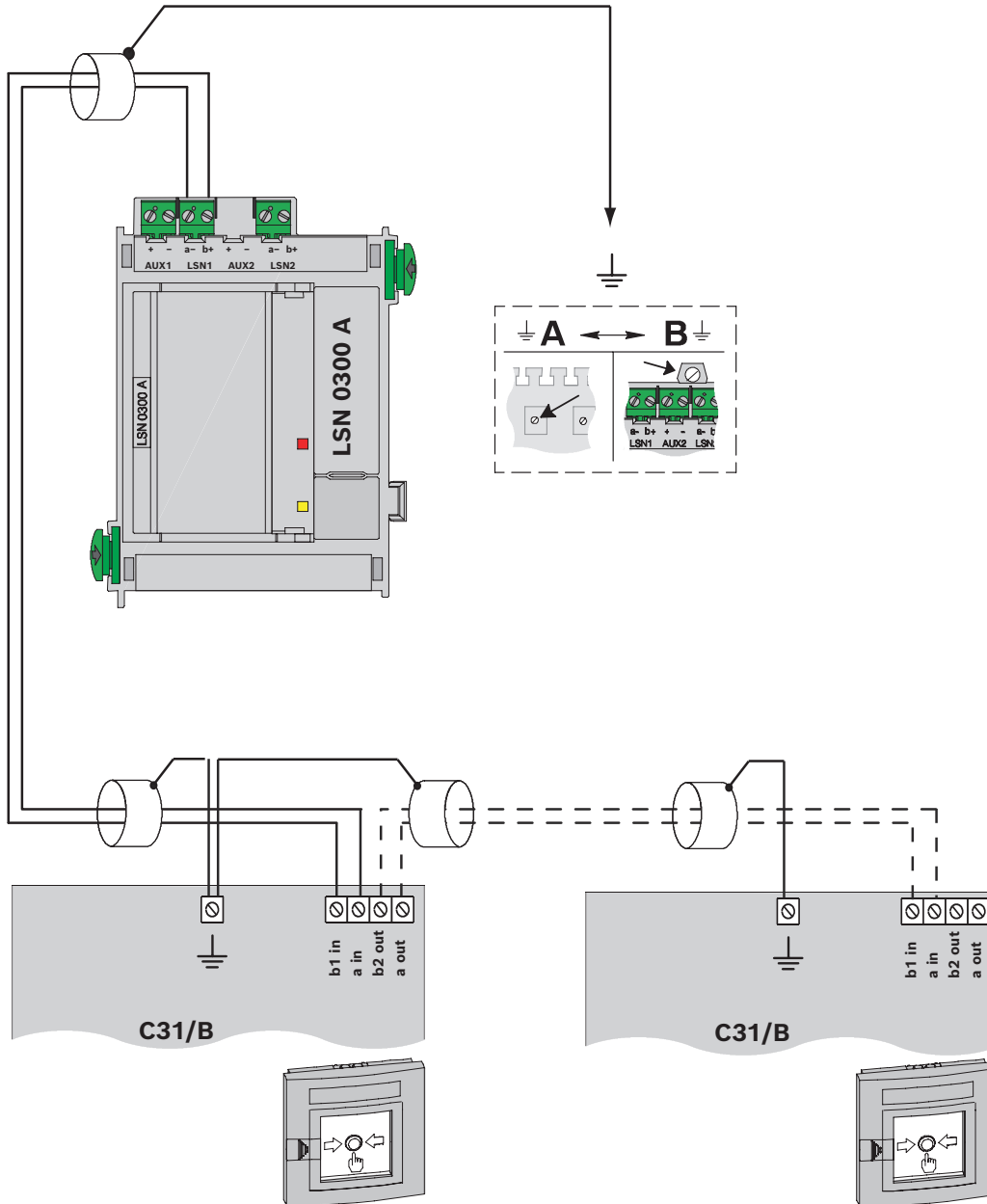
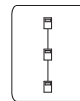
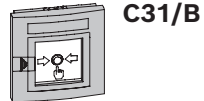
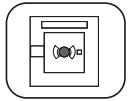

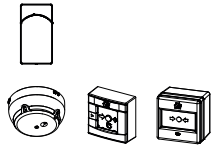

FWI-270

FDOOT271-O
FDM275-O
FDM273-O

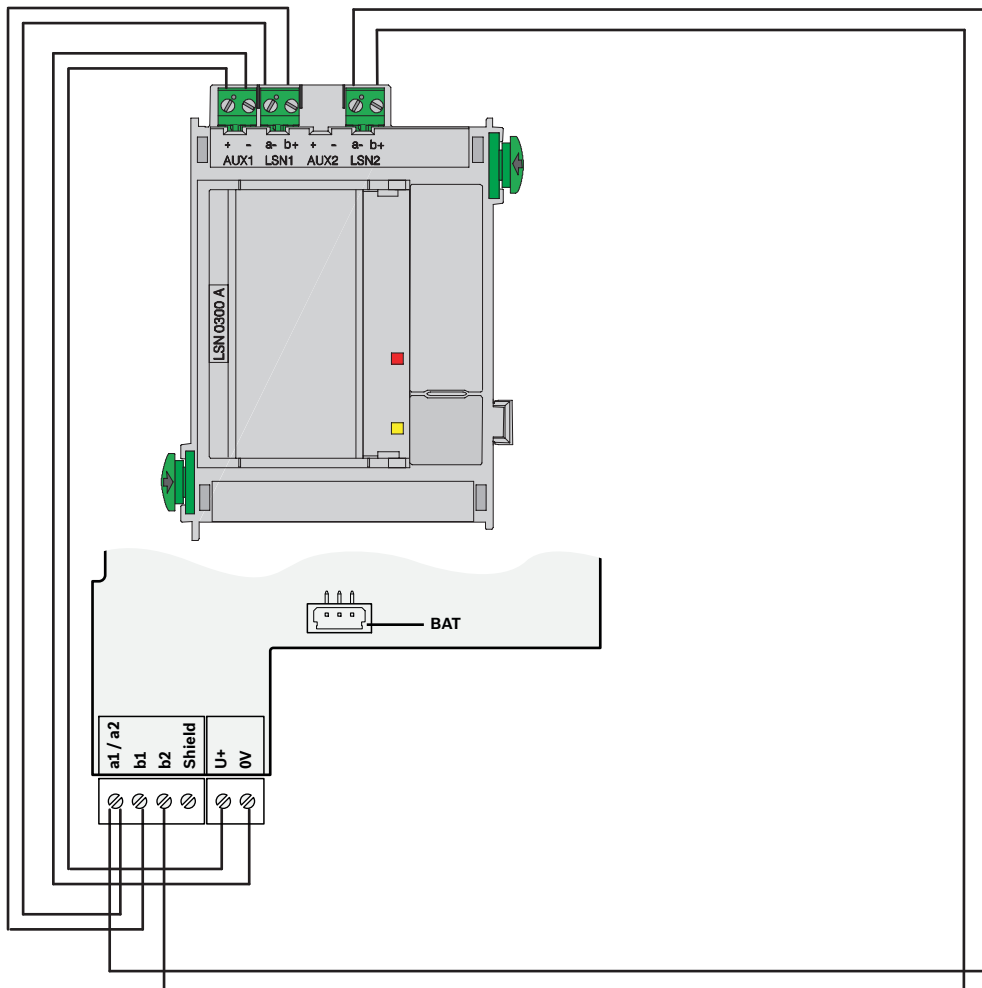
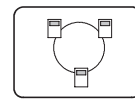

2.4.5

NZM 0002 A

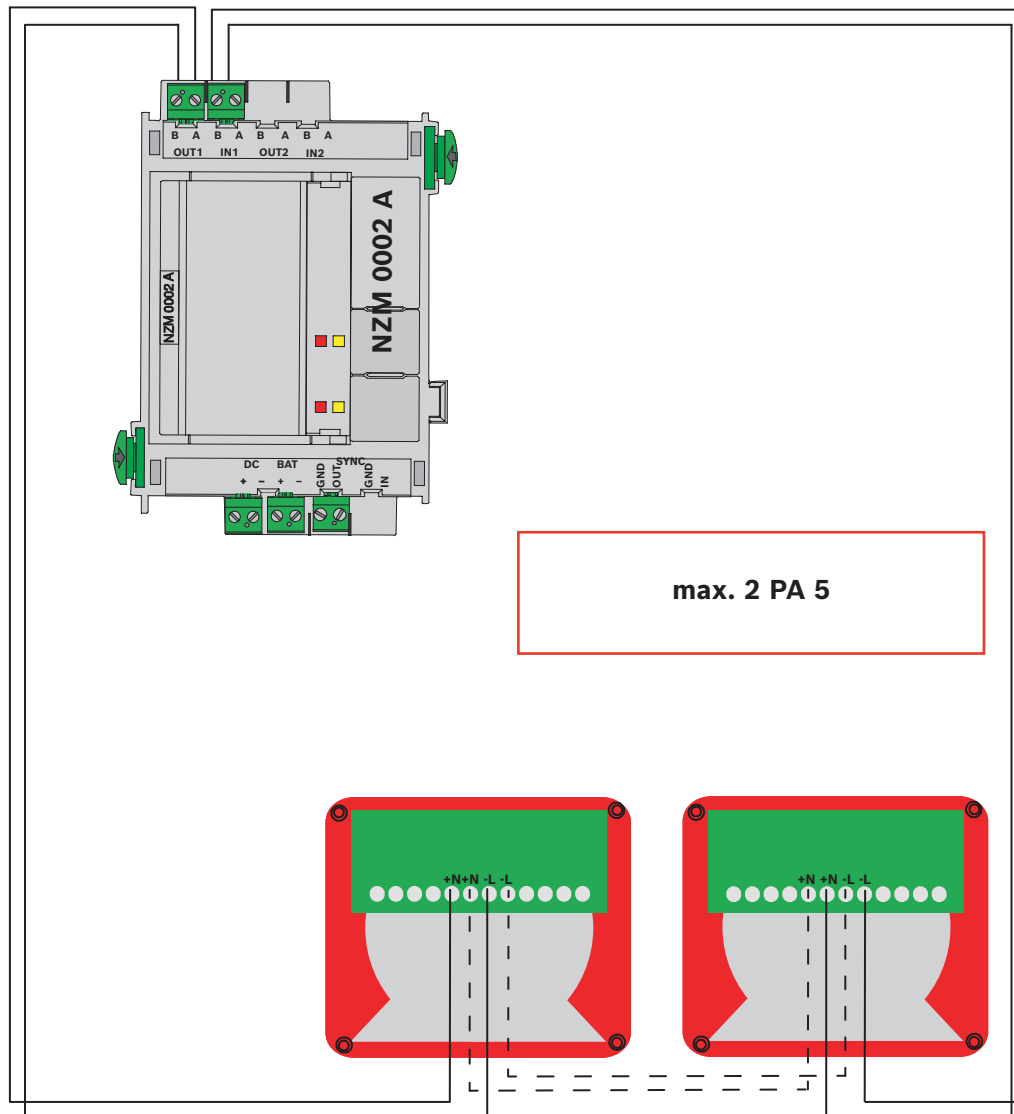
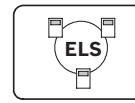

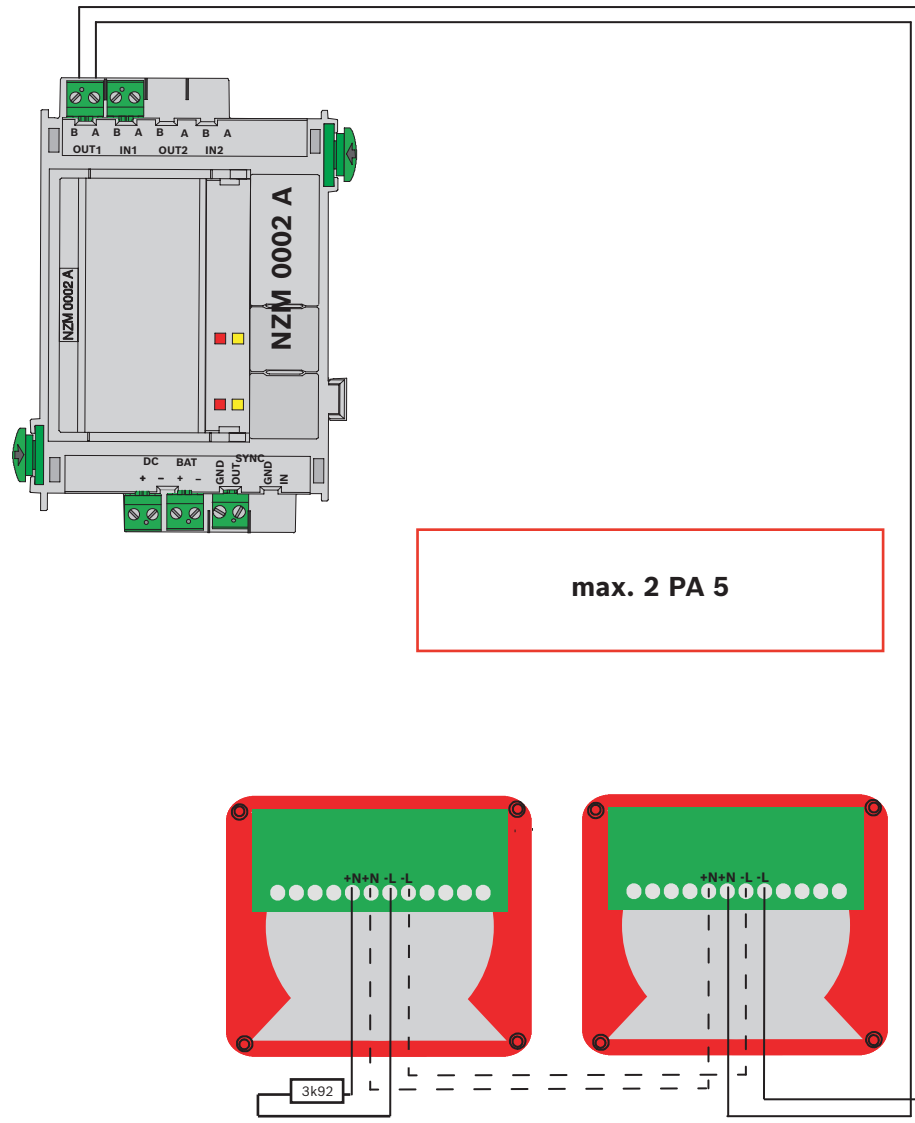
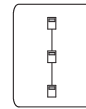

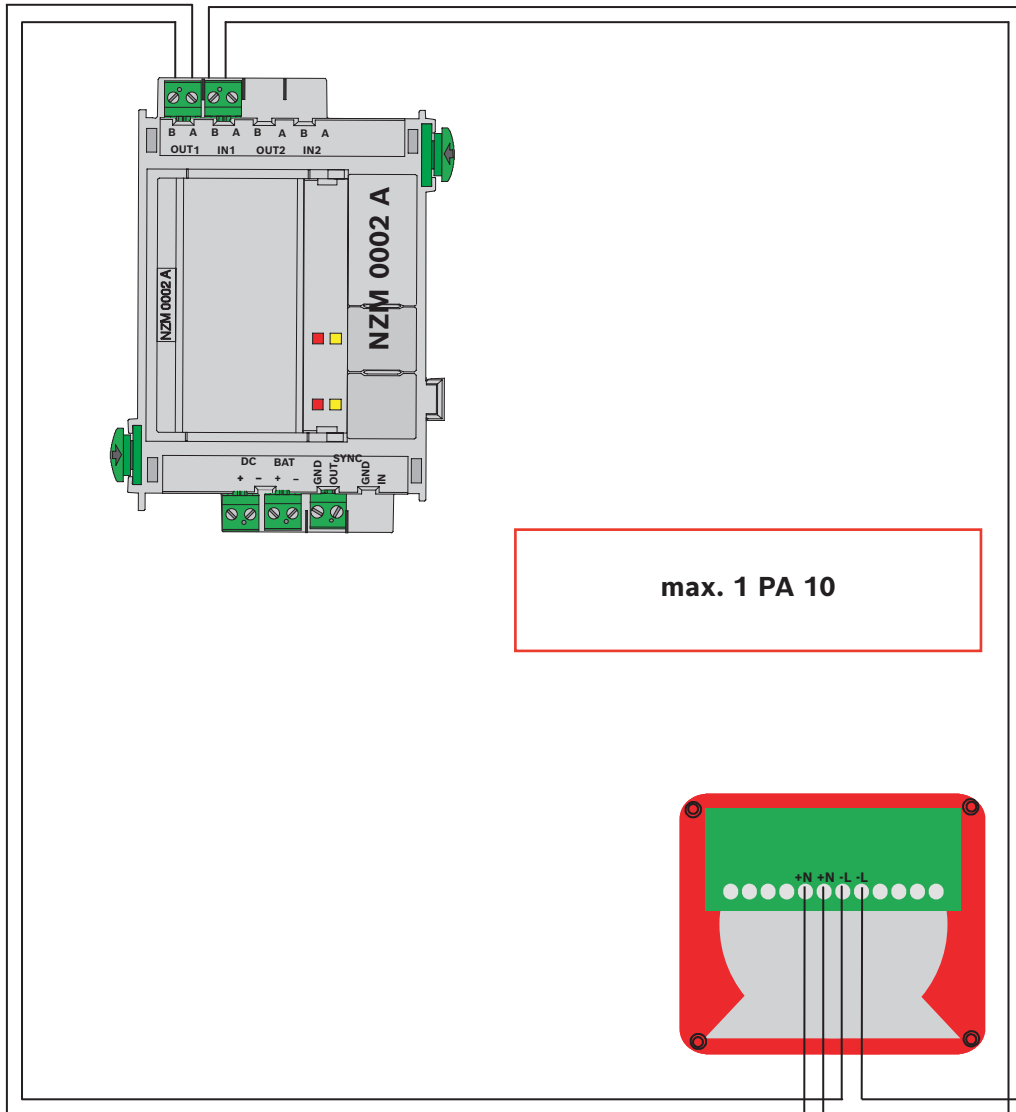
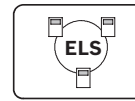

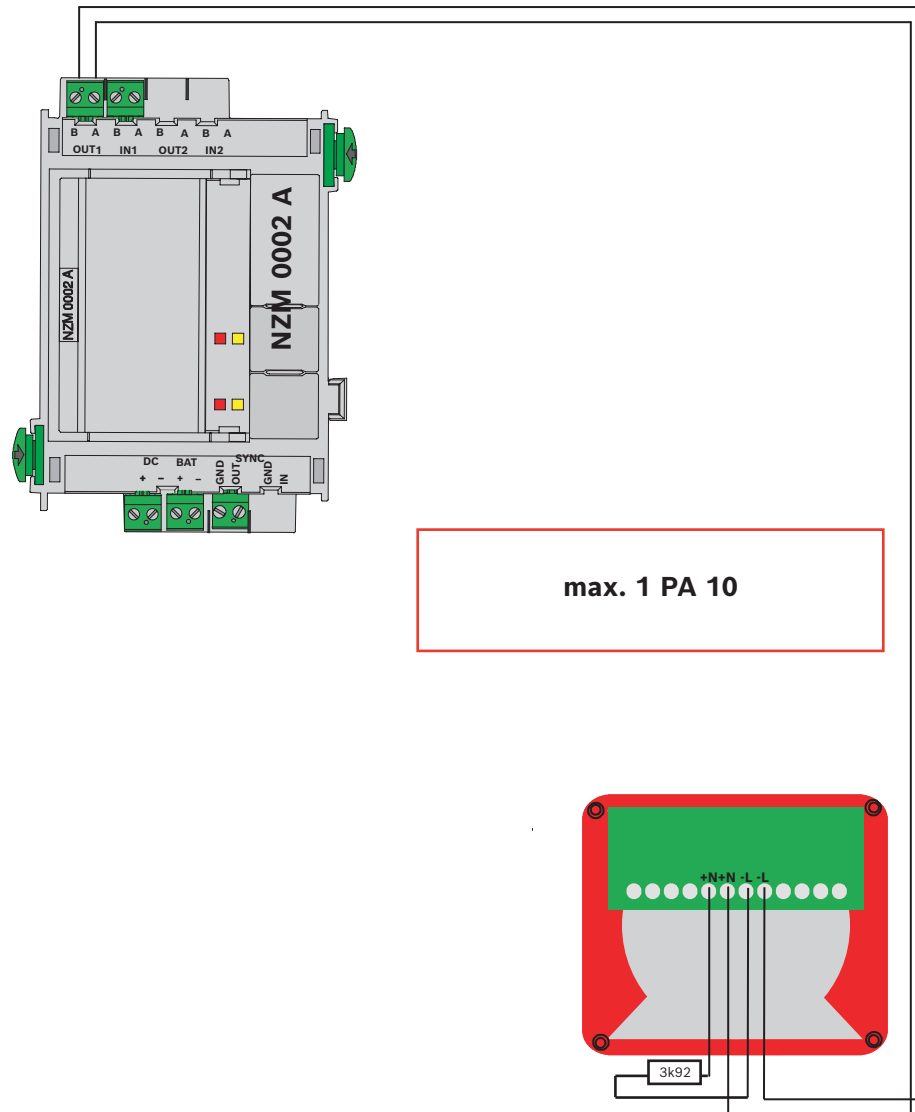
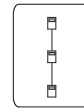

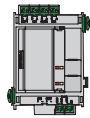
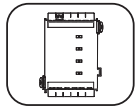

NZM 0002 A

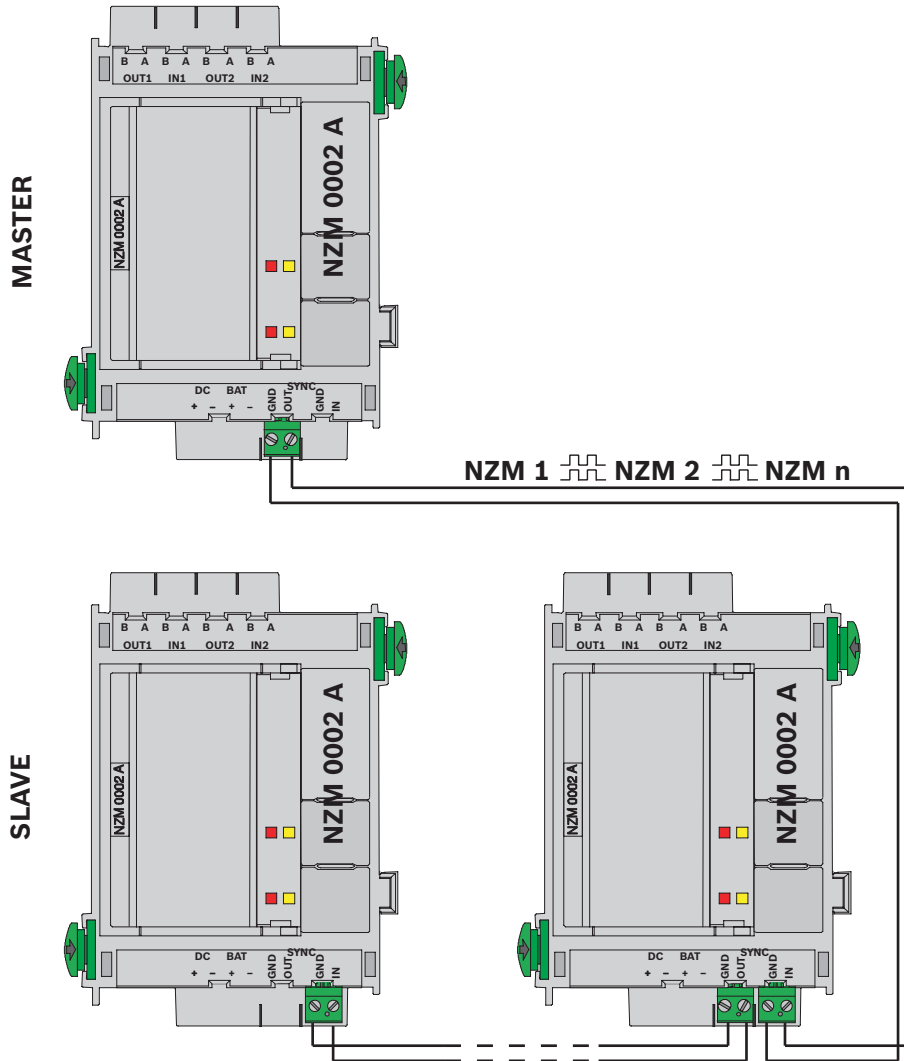

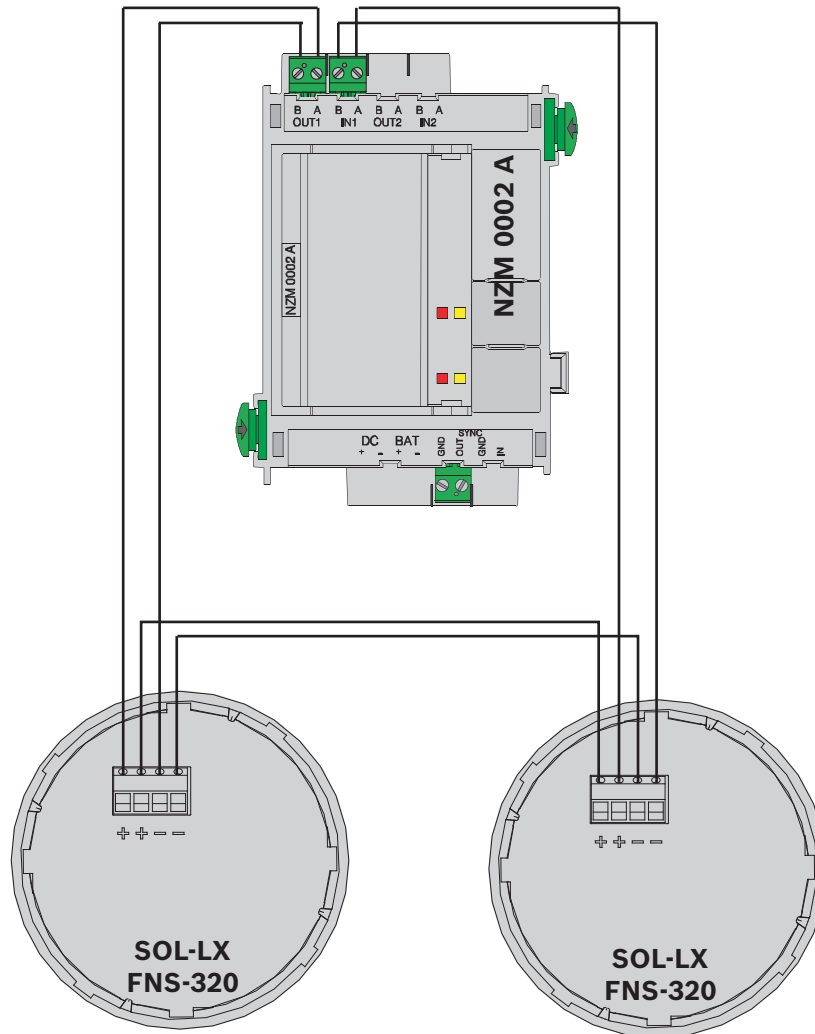
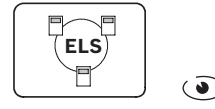

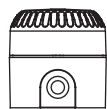

**SOL-LX
FNS-320**

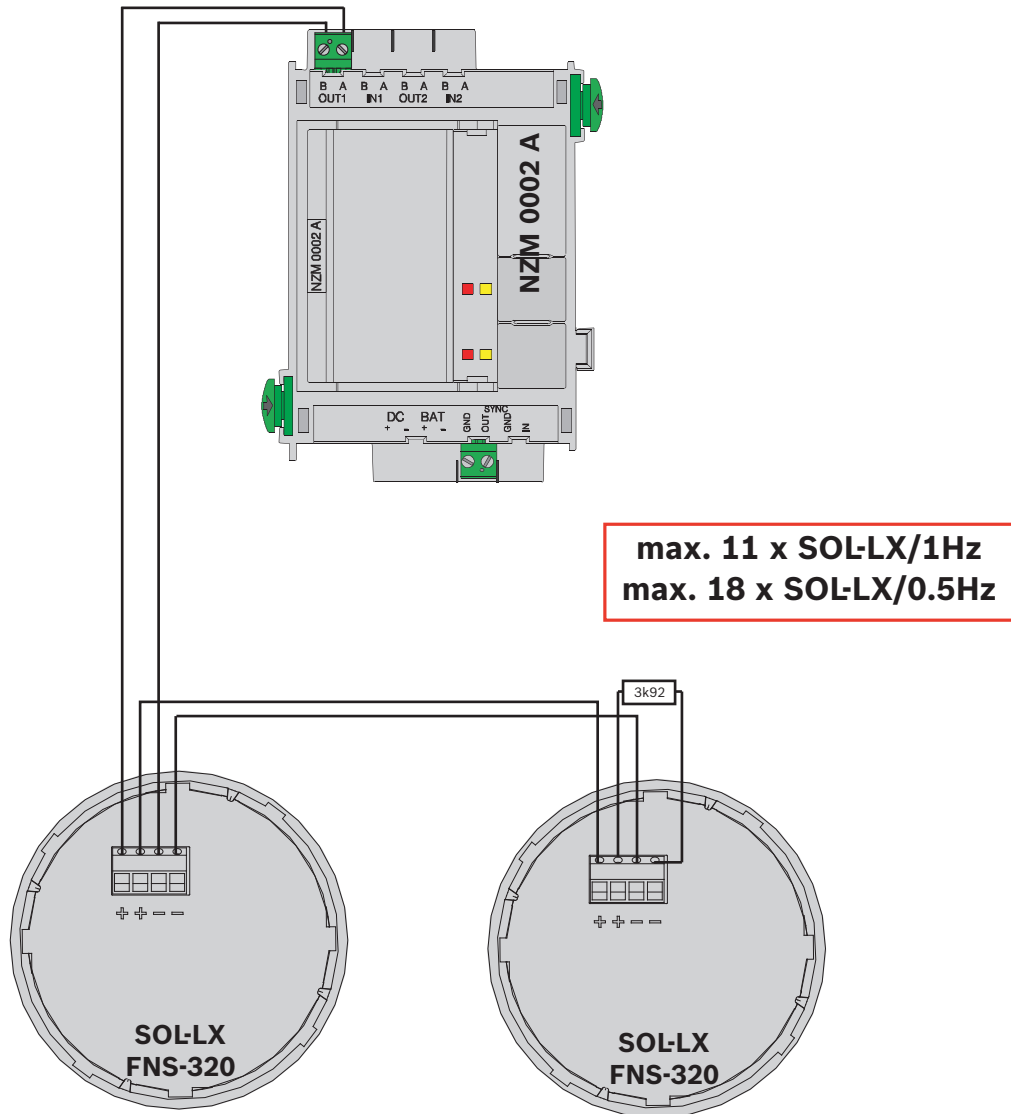
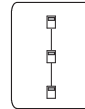

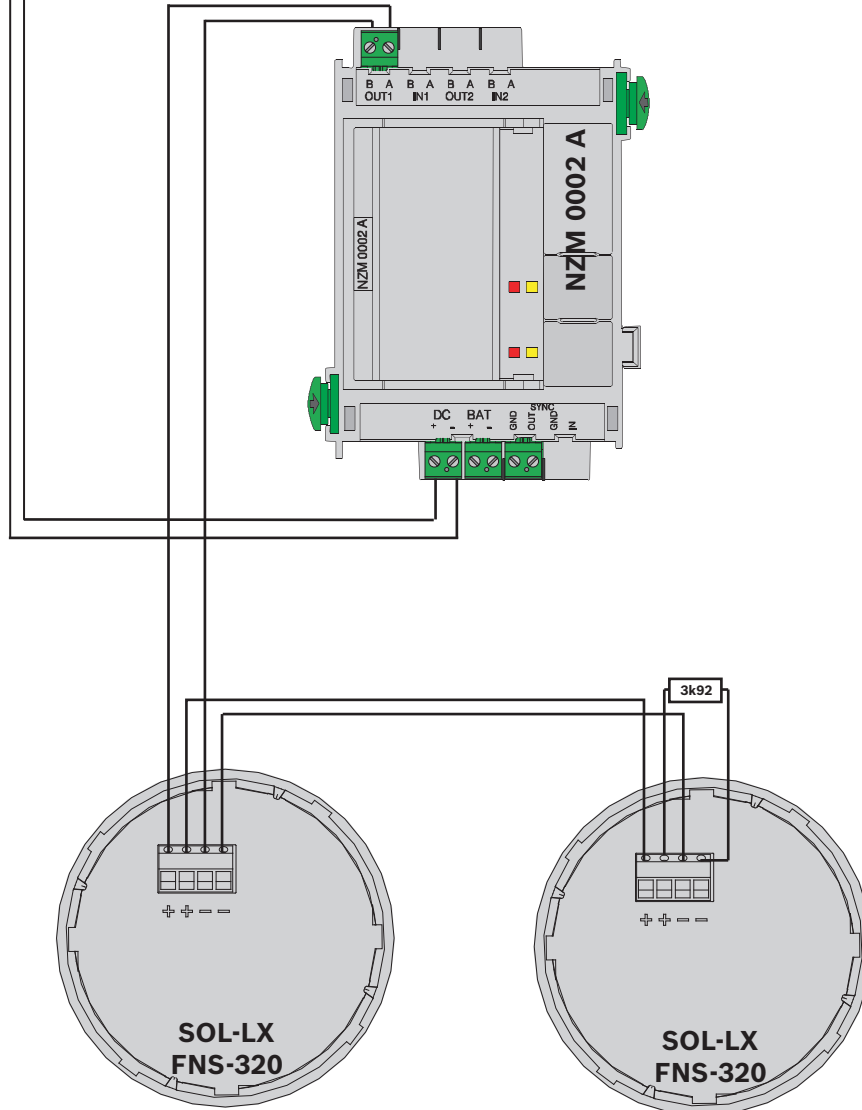
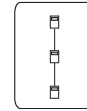

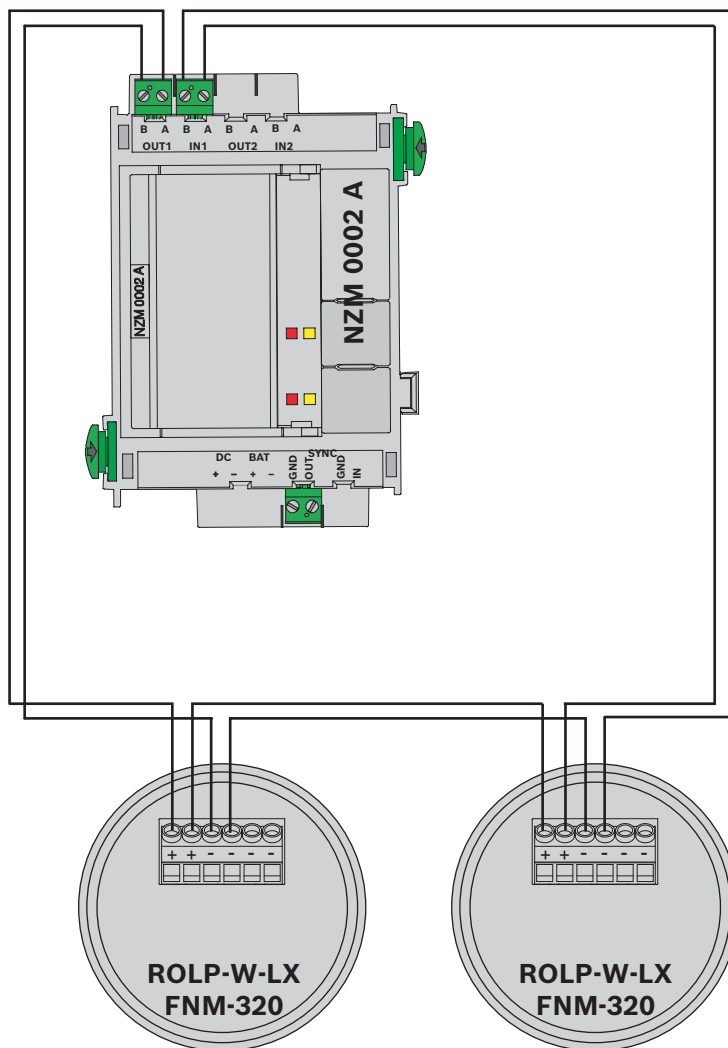
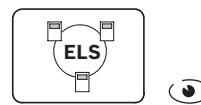

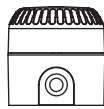

**ROLP-W-LX
FNM-320**

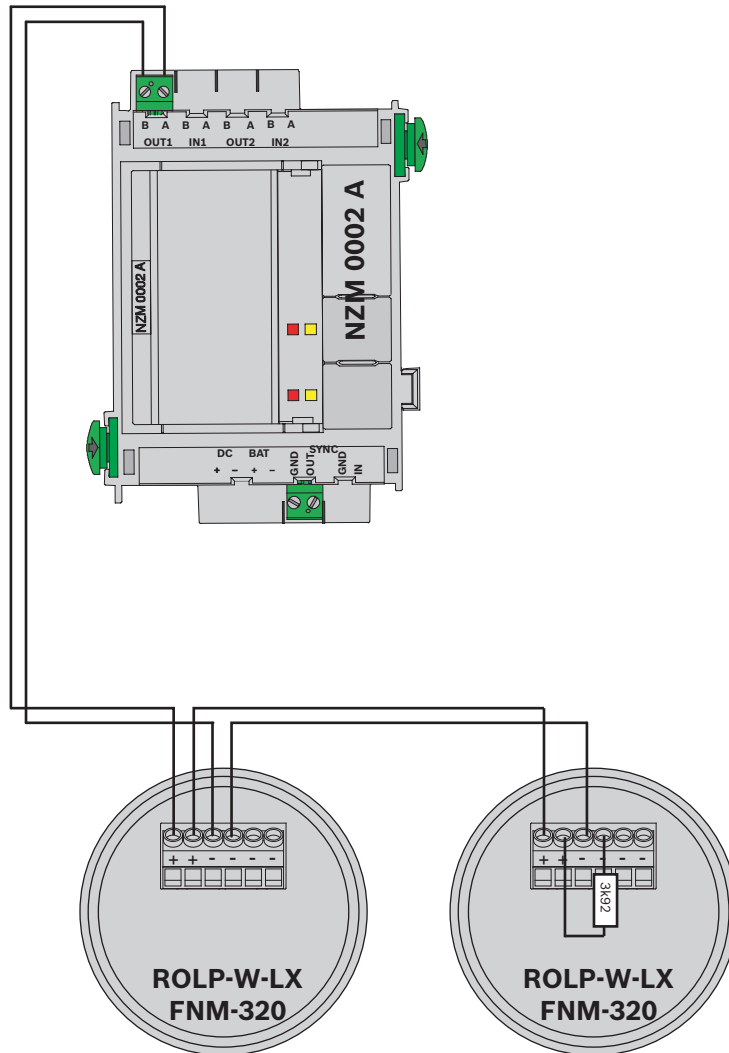
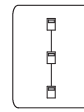



PB 2005

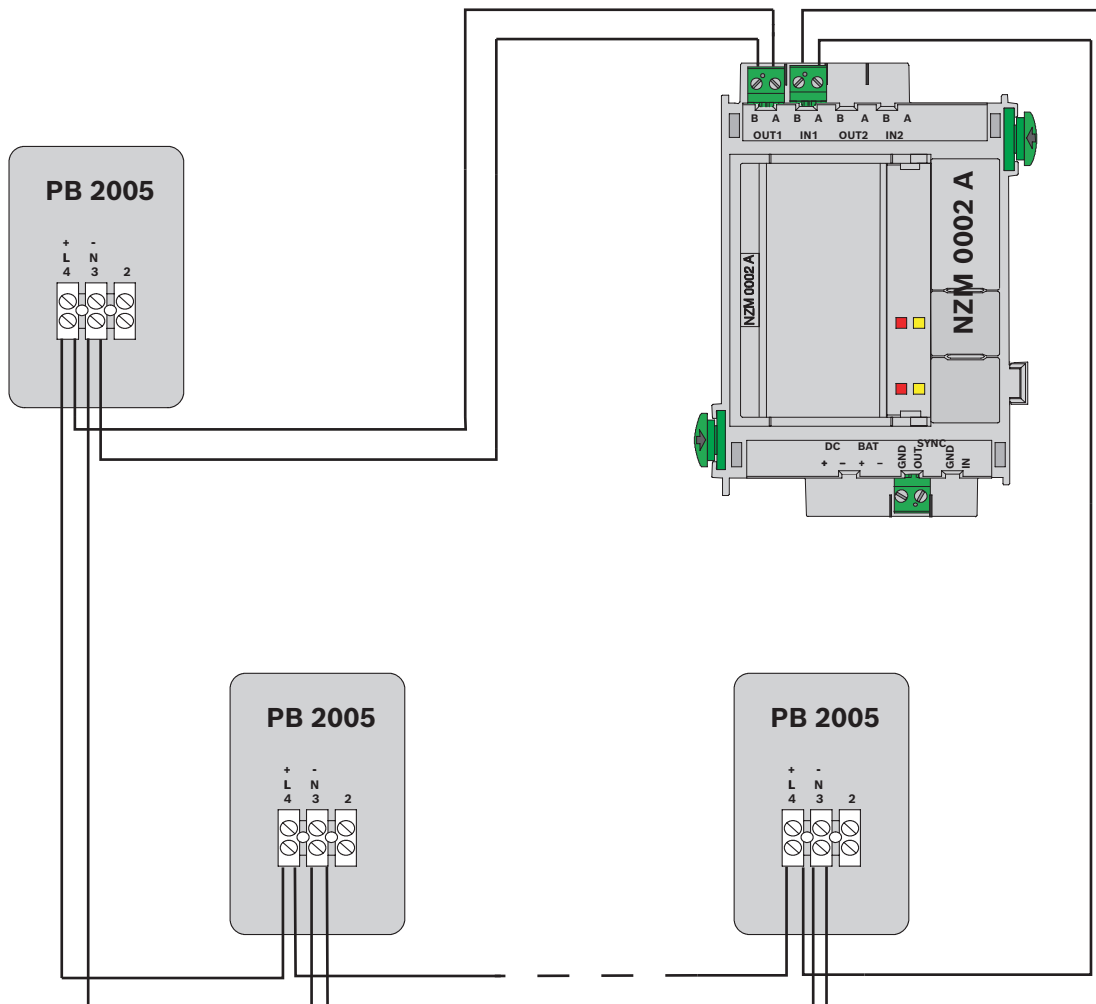
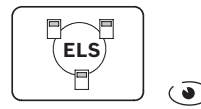



PB 2005

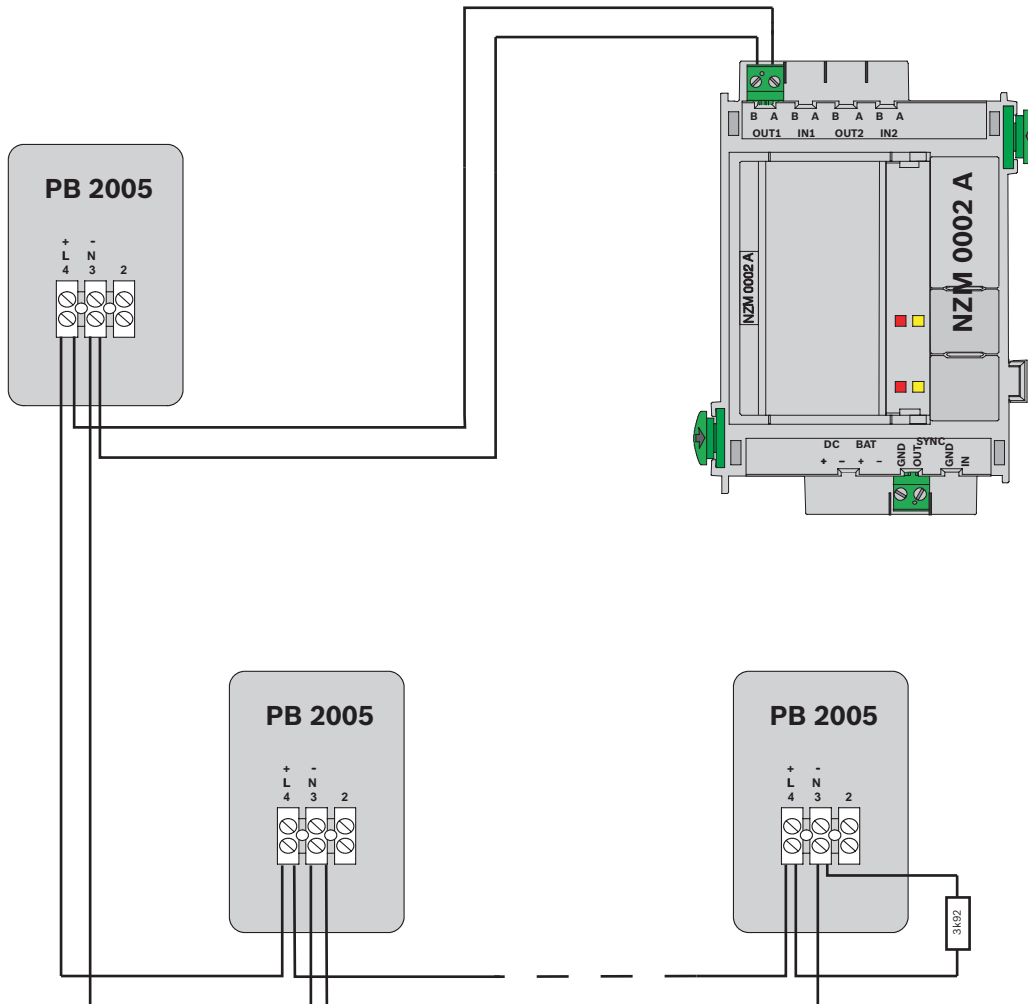
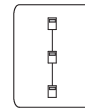



PB 2005

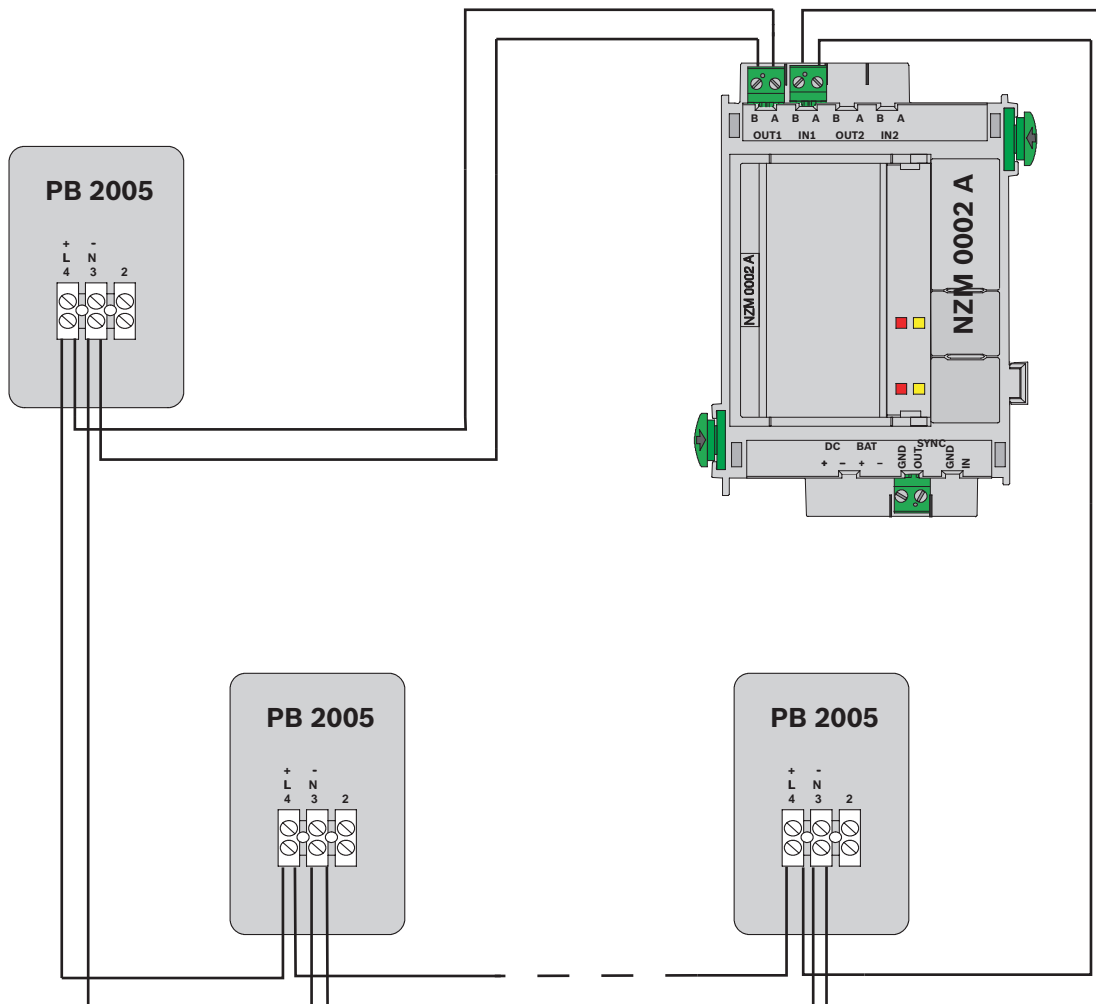
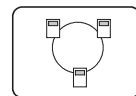

2.4.6

RMH 0002 A

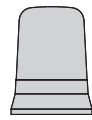

FNS-P400RTH

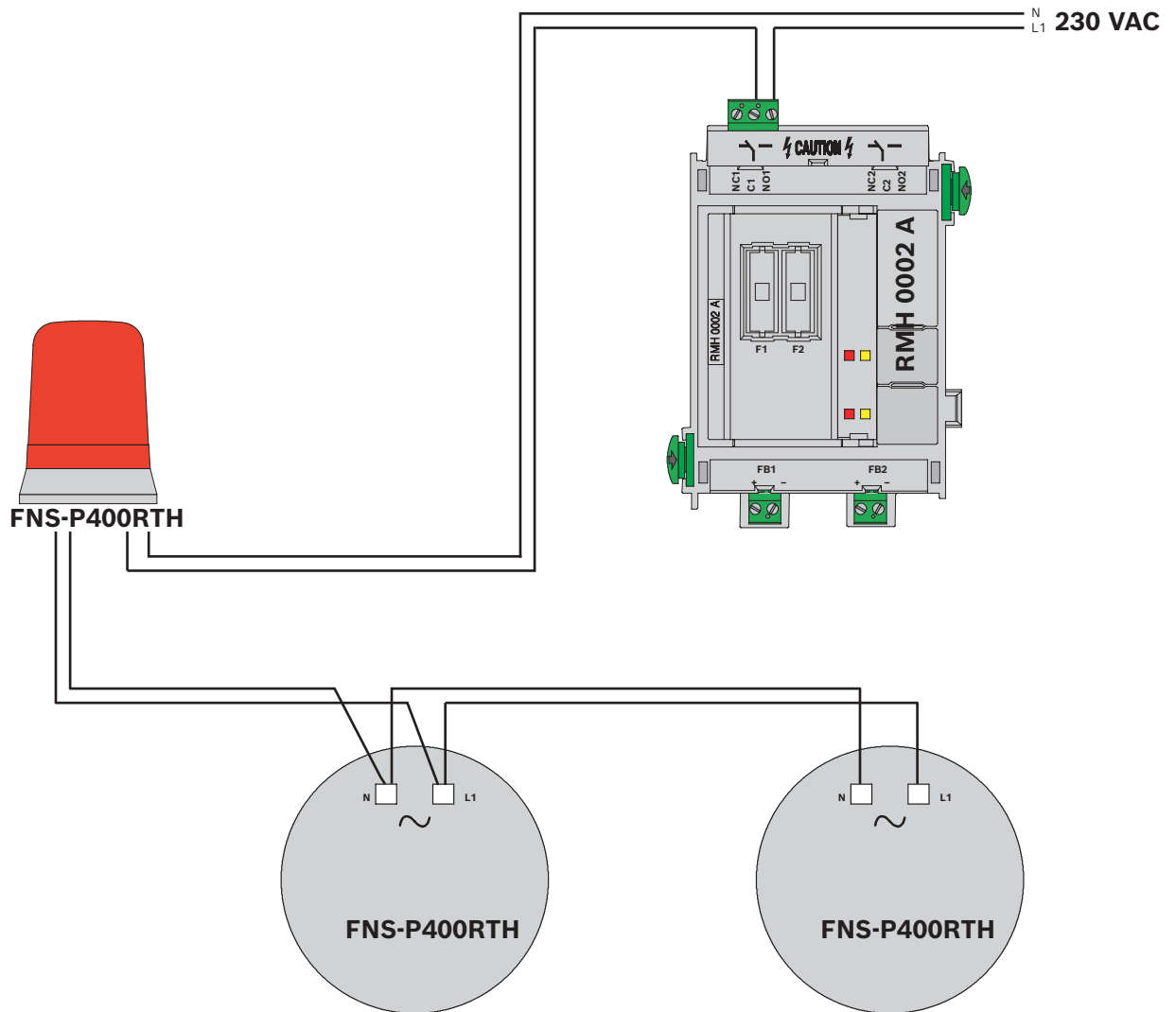
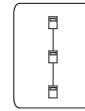

2.4.7 IOS 0020 A

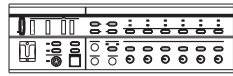
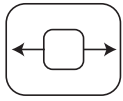

Plena

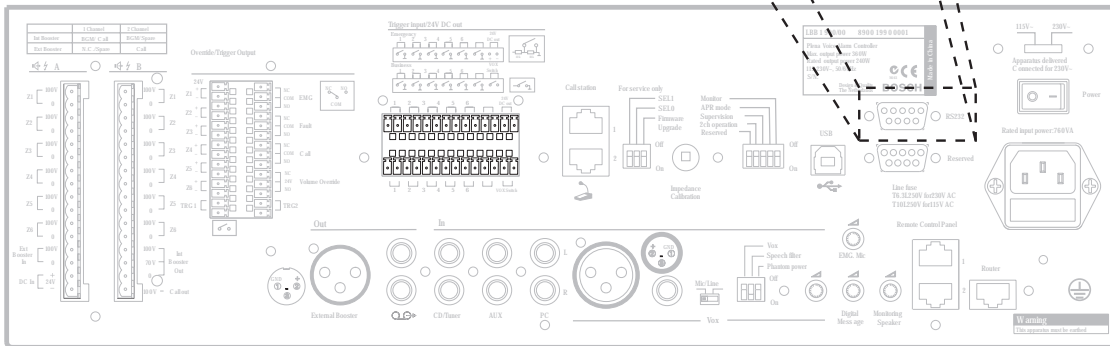
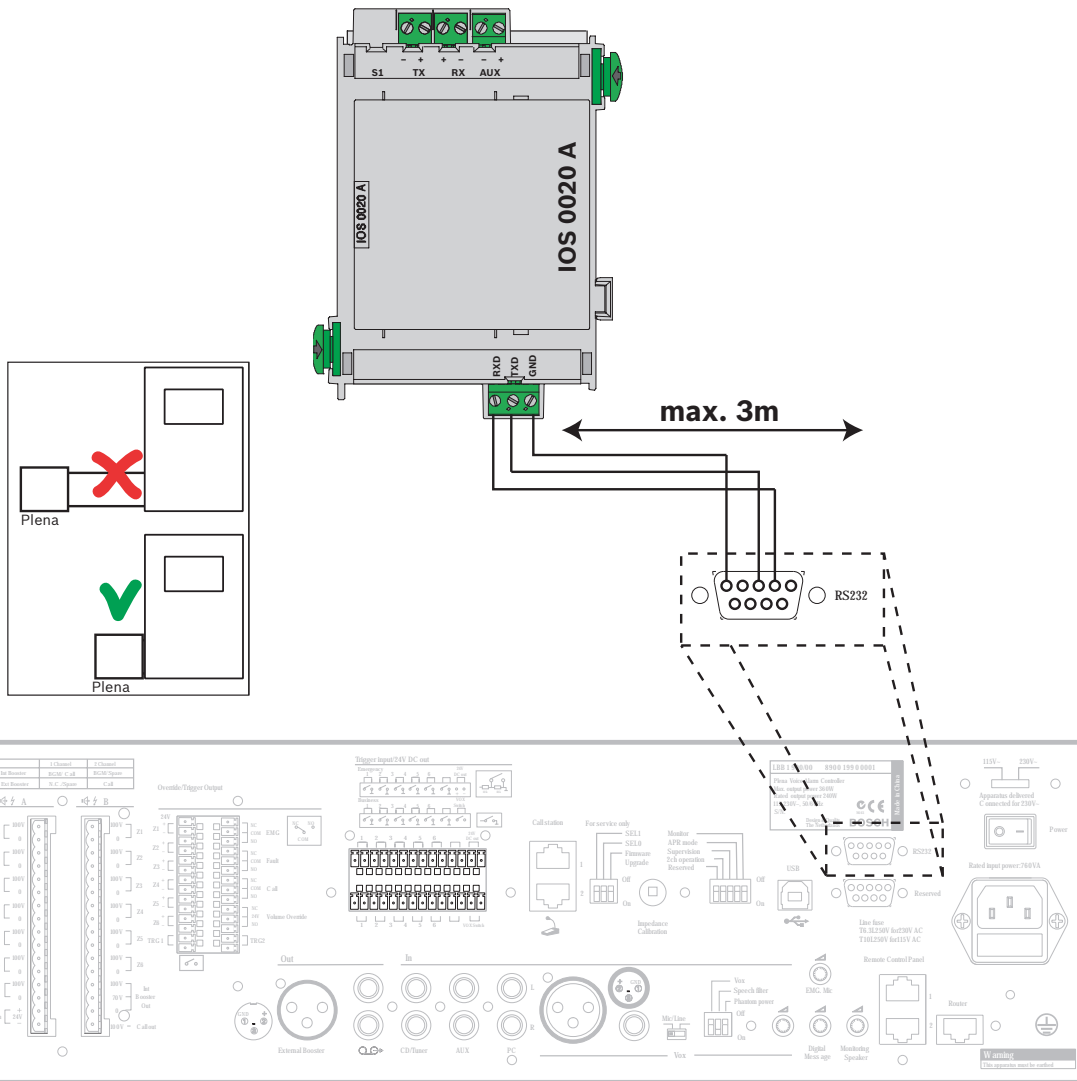



FAT4000 FBF4000 ADP4000

FMF-FAT FMF-FBF-FAT
FMF-FIBS-A4/-A3
FMF-ADP

ELS

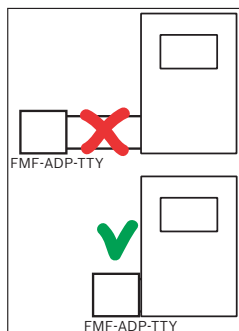
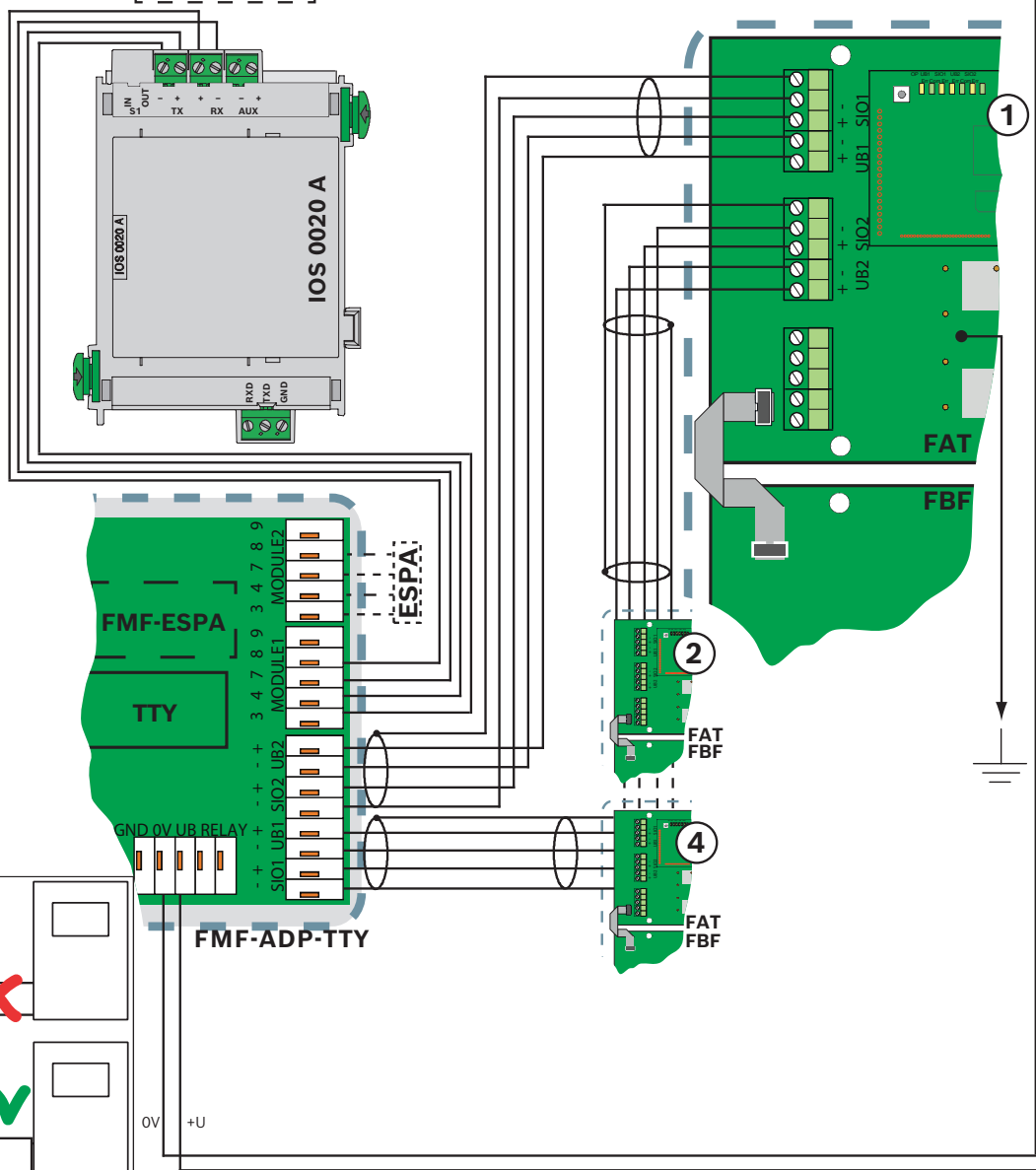
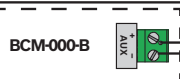

2.4.8 FPE-5000-UGM



FAT4000 FBF4000 ADP4000
 FMF-FAT FMF-FBF-FAT
 FMF-FIBS-A4/-A3
 FMF-ADP

ELS

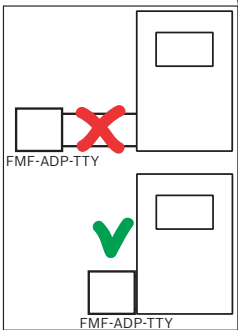
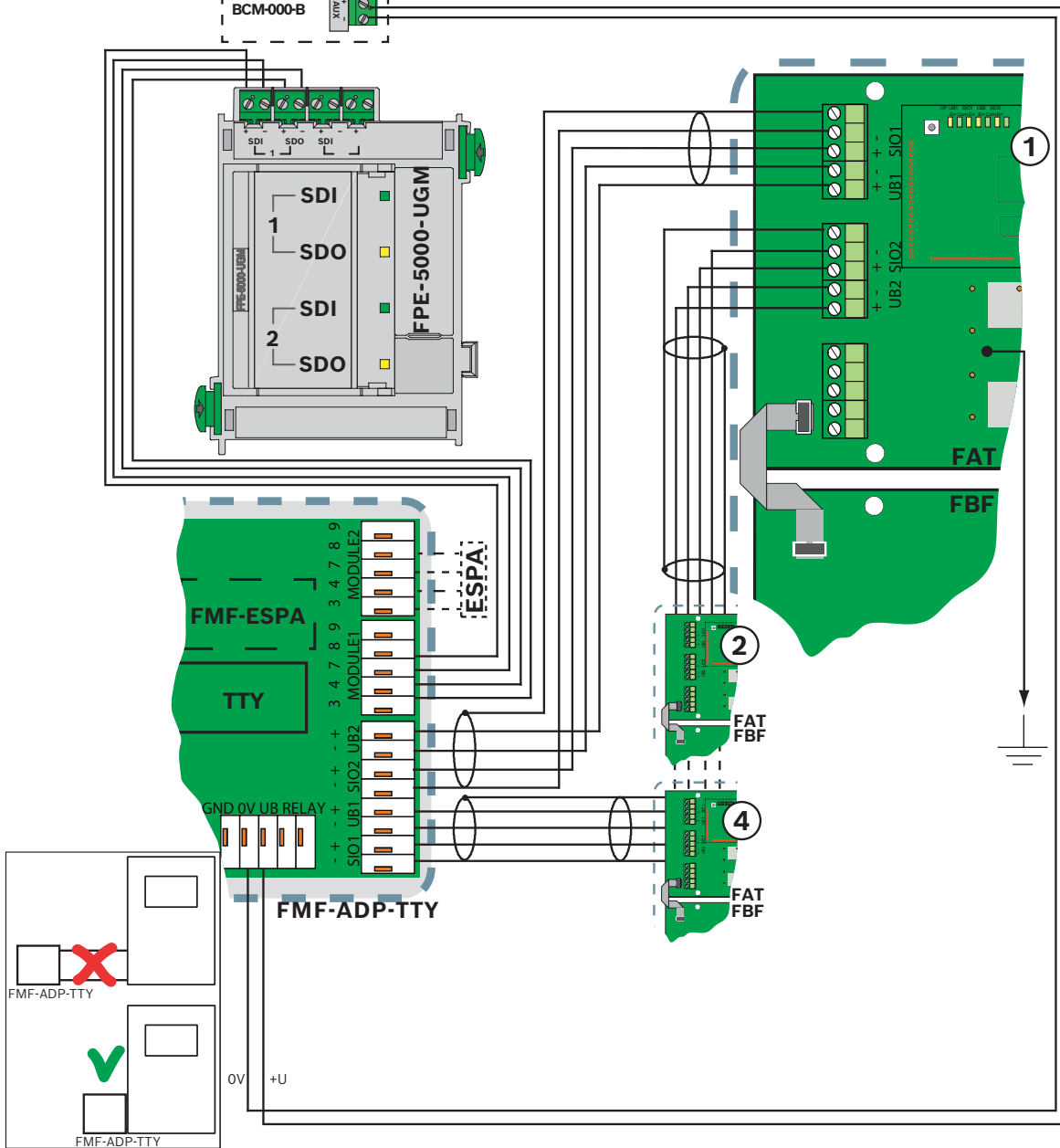

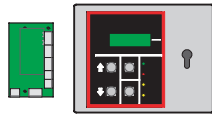

FAT2002RE
ADP-NE

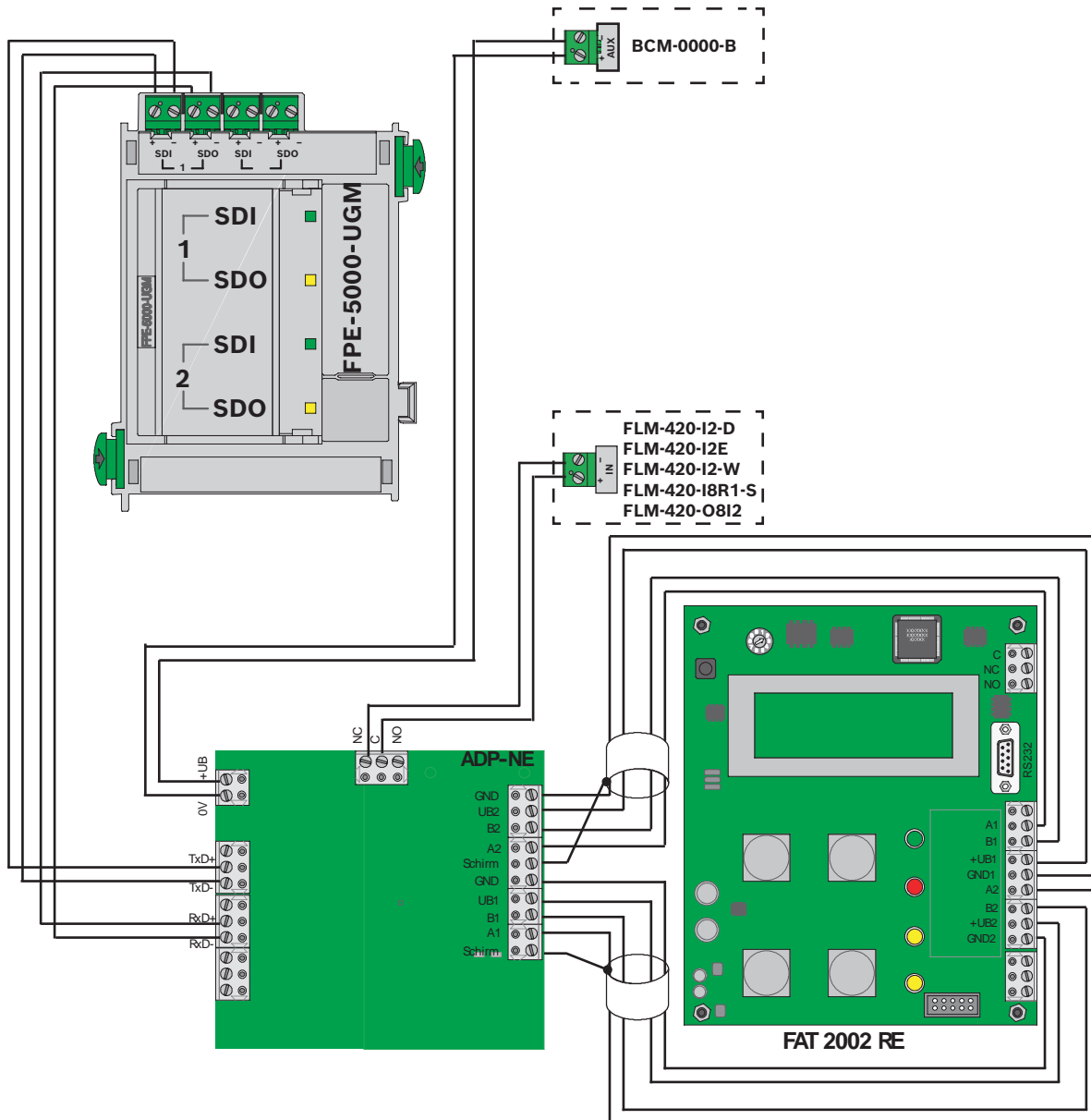

2.5

Interface Modules



FLM-420-4/CON-D/S, stranica 125

FLM-420-I8R1-S, stranica 158

FLM-420-NAC-D/S, stranica 160

FLM-420-RHV, stranica 172

FLM-420-RLE-S, stranica 184

FLM-420-RLV1-E, stranica 185

FLM-420-RLV8-S, stranica 186

FMF-ADP-FBF/FMF-ADP-TTY, stranica 187

2.5.1 FLM-420-4/CON-D/S

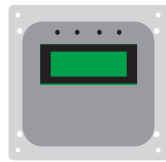

ALARMLINE II

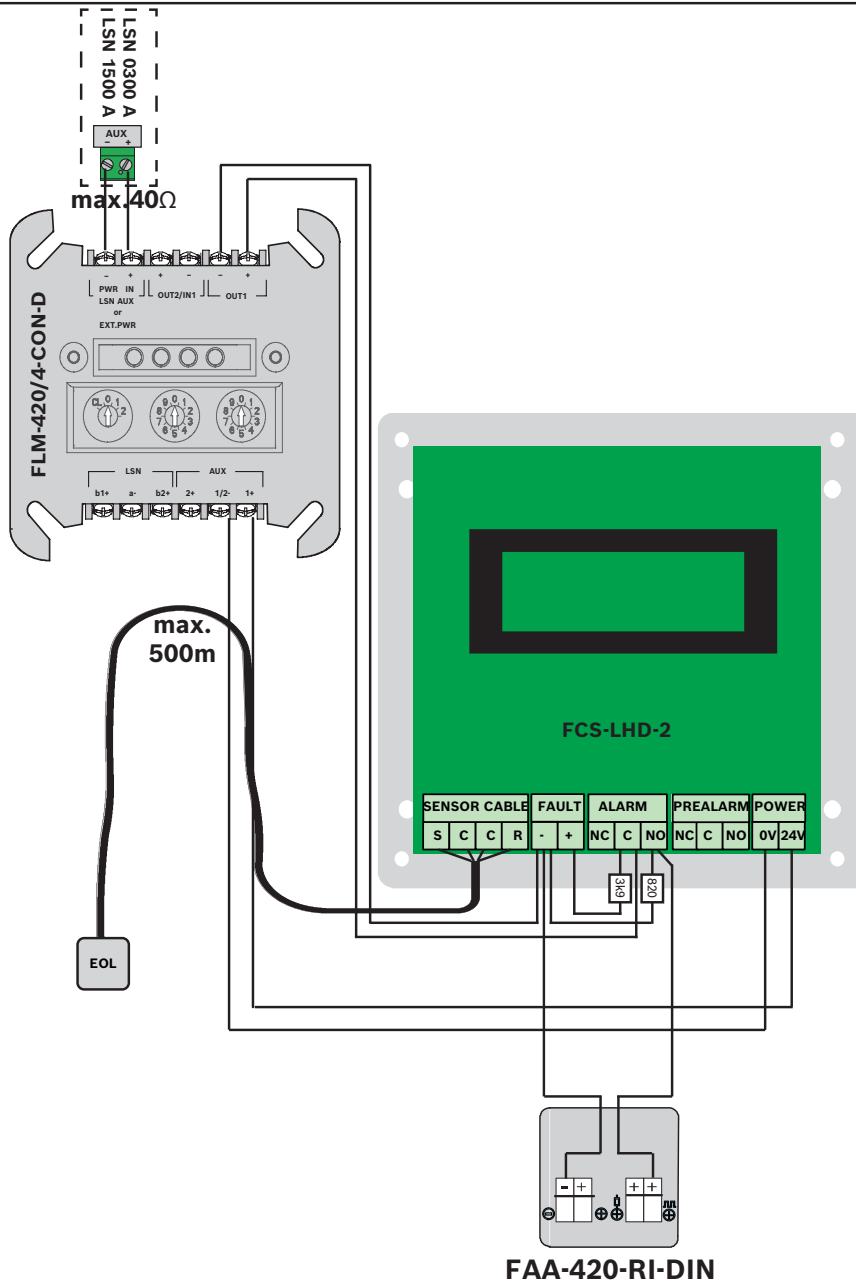
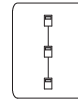

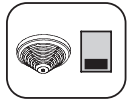

FCS-LWM-1

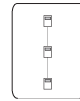

ELS

BCM-0000-B
LSN 0300 A
LSN 1500 A

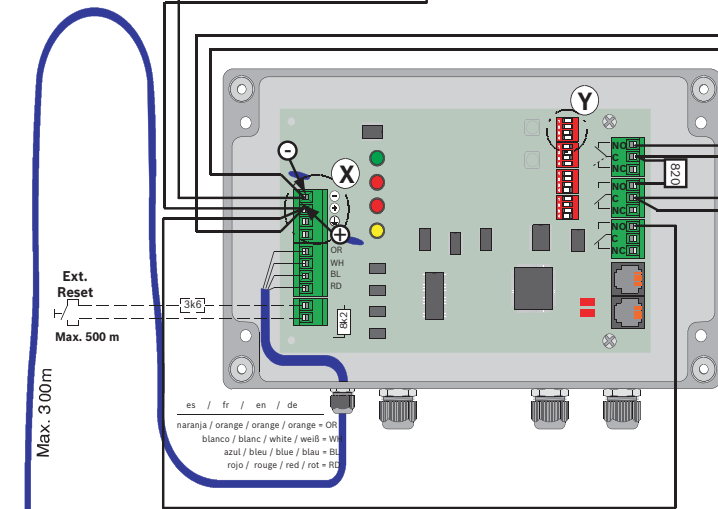
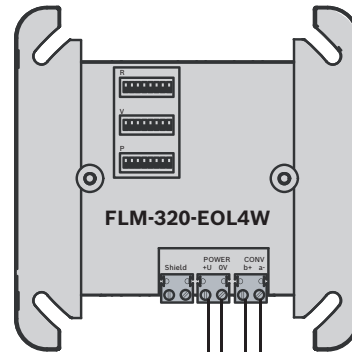
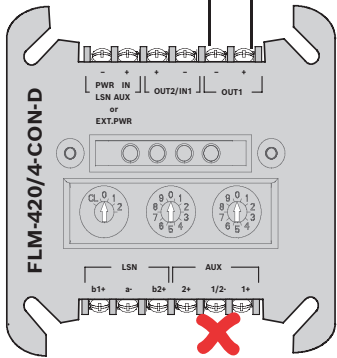



FCS-LWM-1

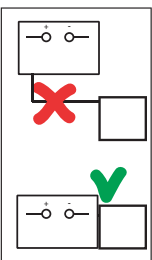
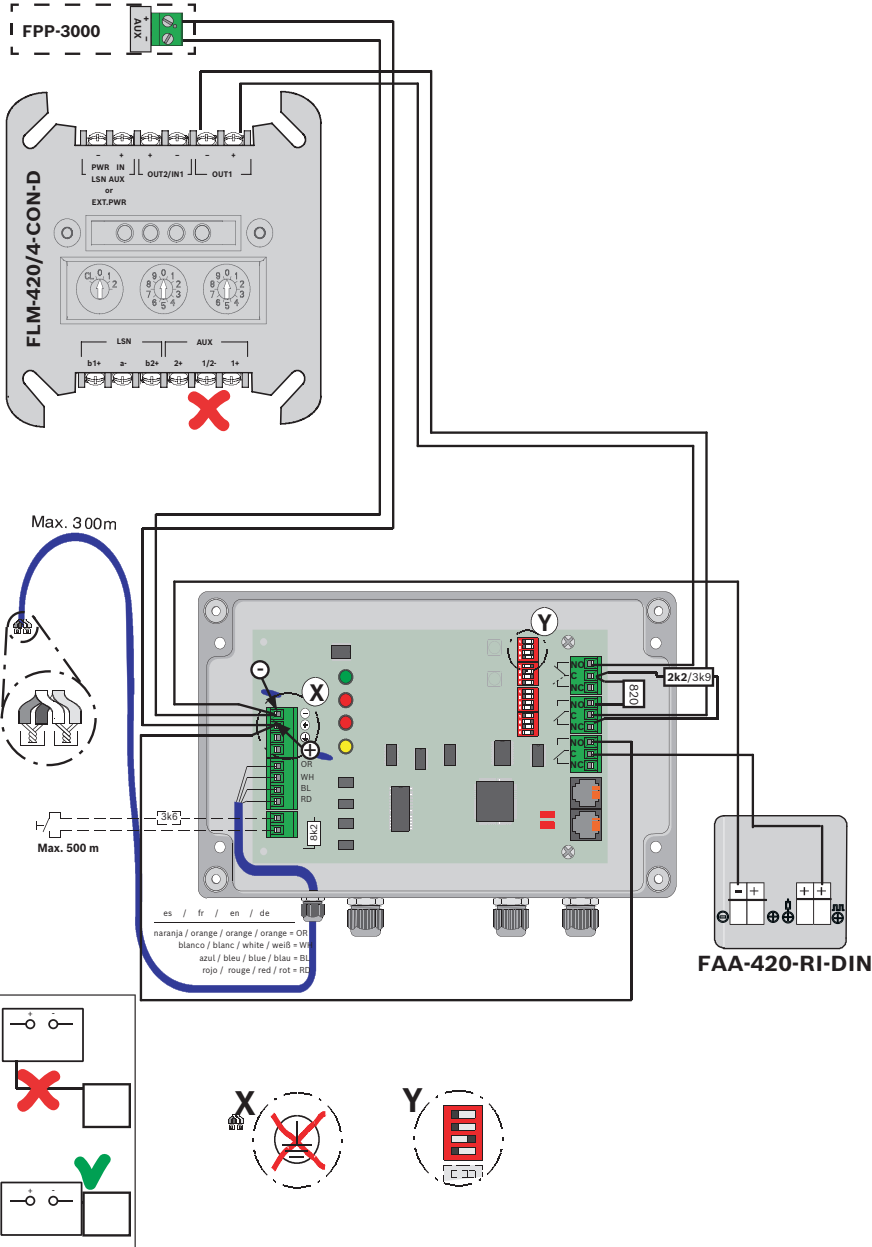



FCA-500-EU
 FCP-O 500
 FCP-O 500-P
 FCP-OC 500
 FCP-OC 500-P

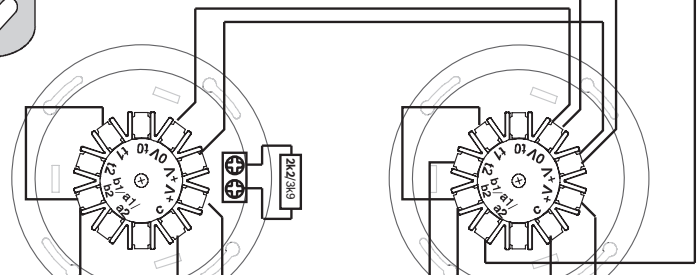
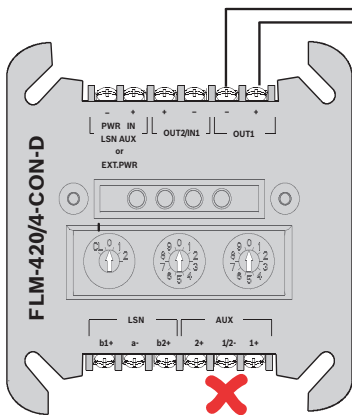

FCA-500-E-EU

FCA-500-EU

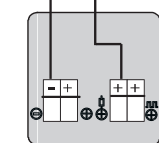

FAA-420-RI-DIN

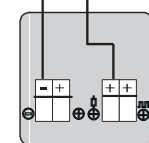

FAA-420-RI-DIN

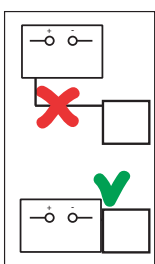

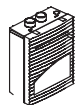

FCS-320-TM Series



BCM-0000-B
LSN 0300 A
LSN 1500 A

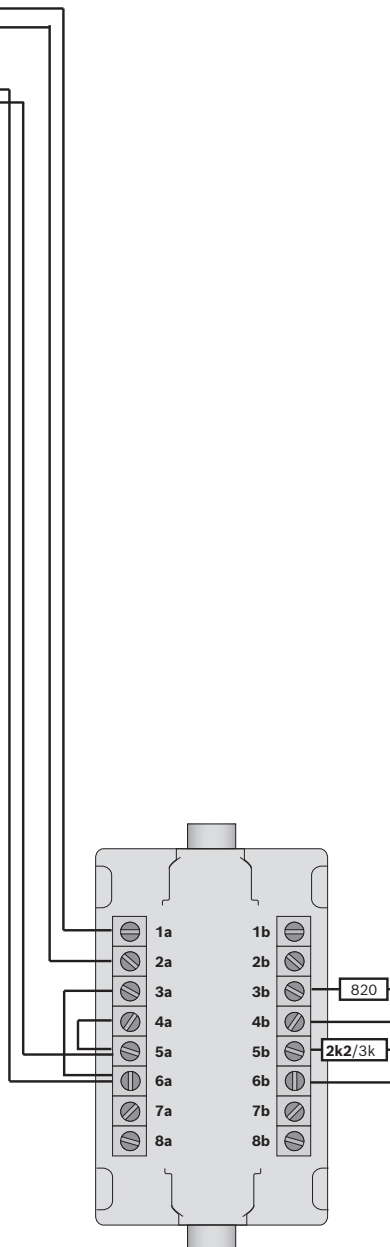
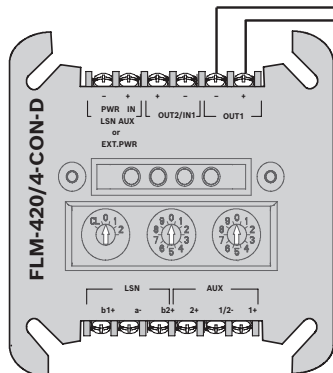

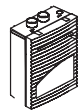

FCS-320-TP Series

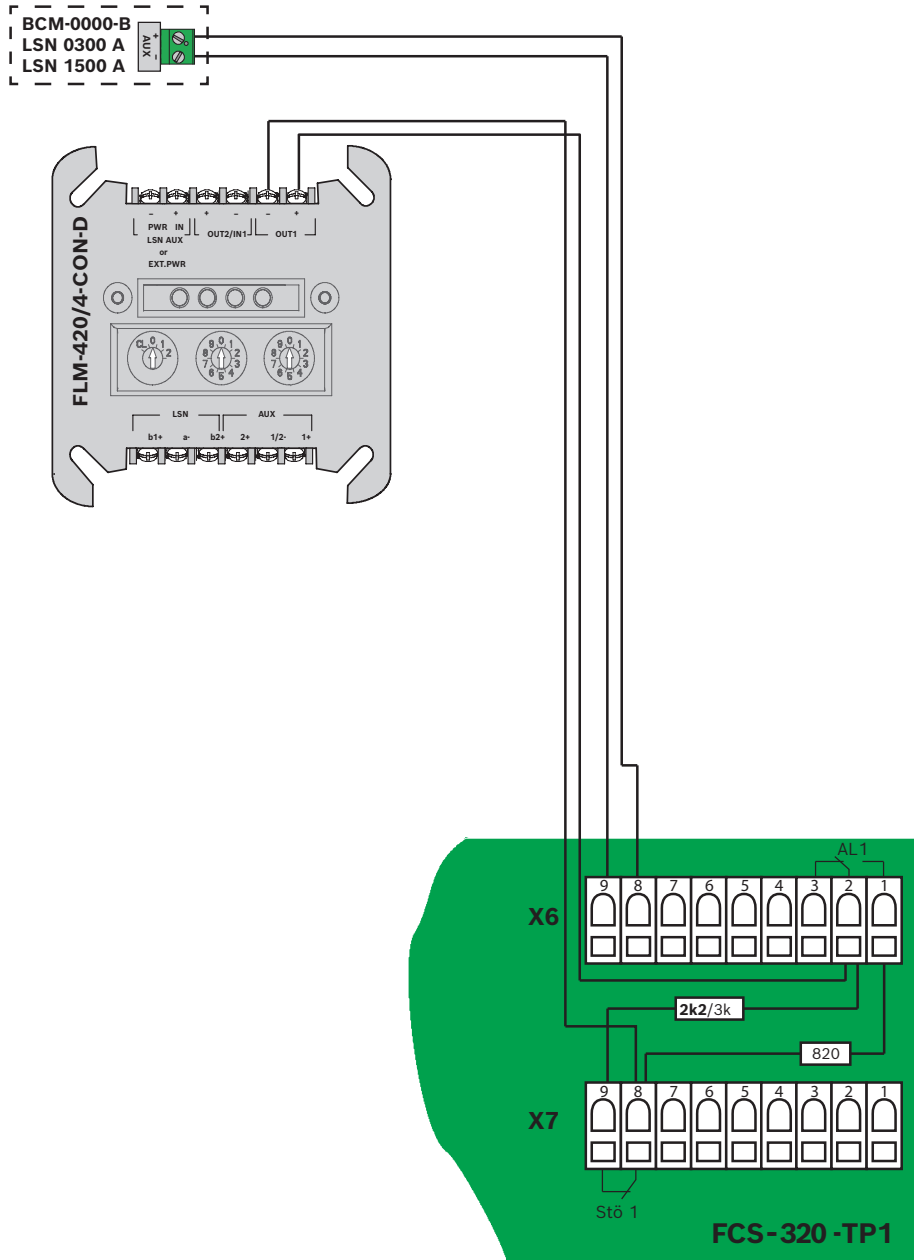
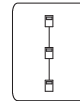

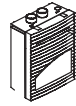

FCS-320-TP Series

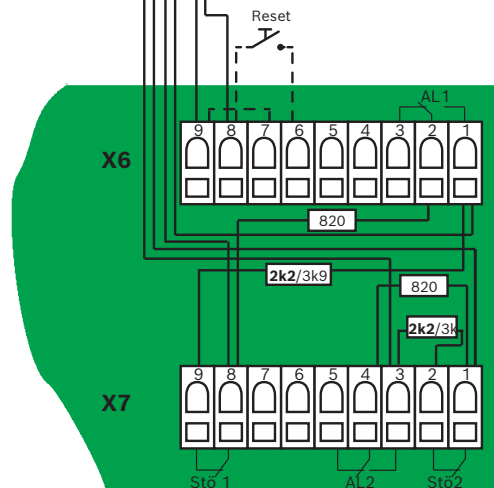
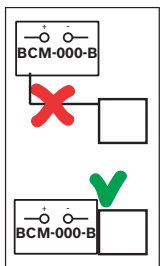
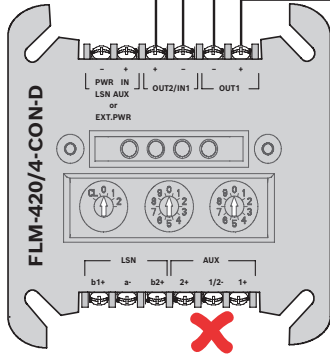
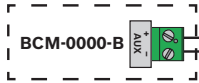

FCS-320-TP2

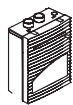

FCS-320-TP1

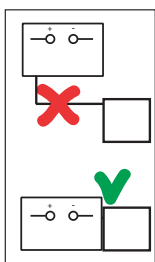
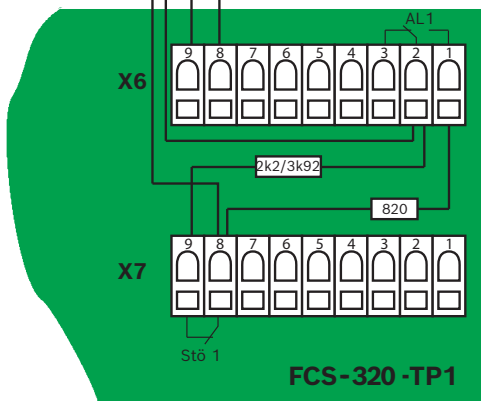
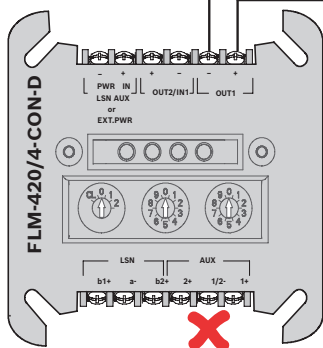

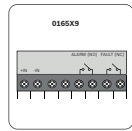

**016519, 016589
IR3 Flame Detector**

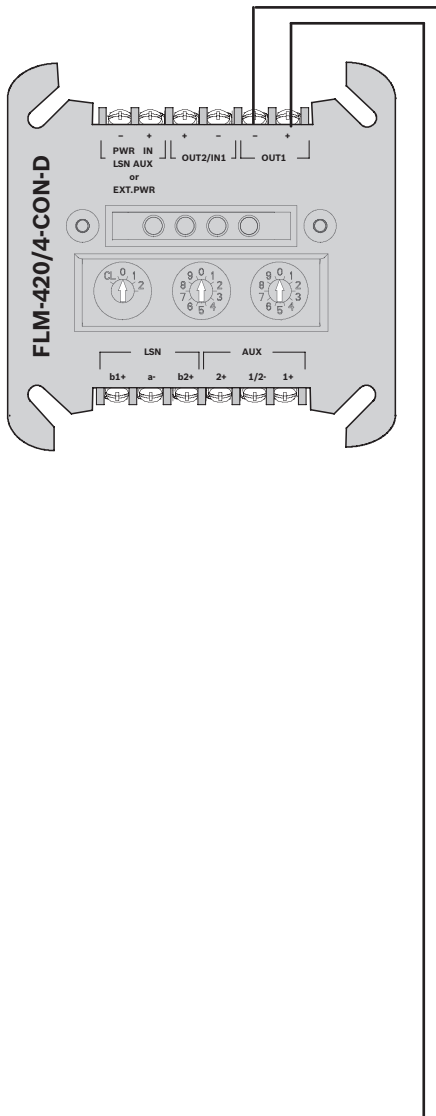
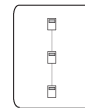

max. 1 x 0165X9

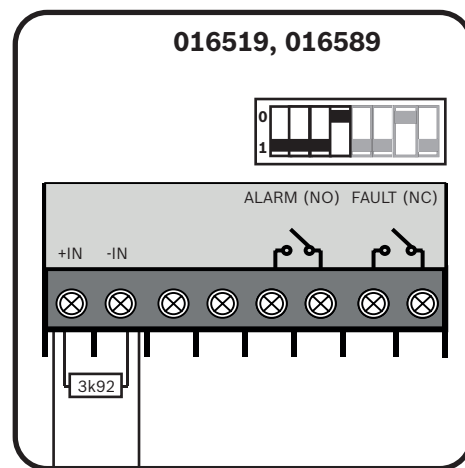

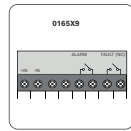

016519, 016589
IR3 Flame Detector

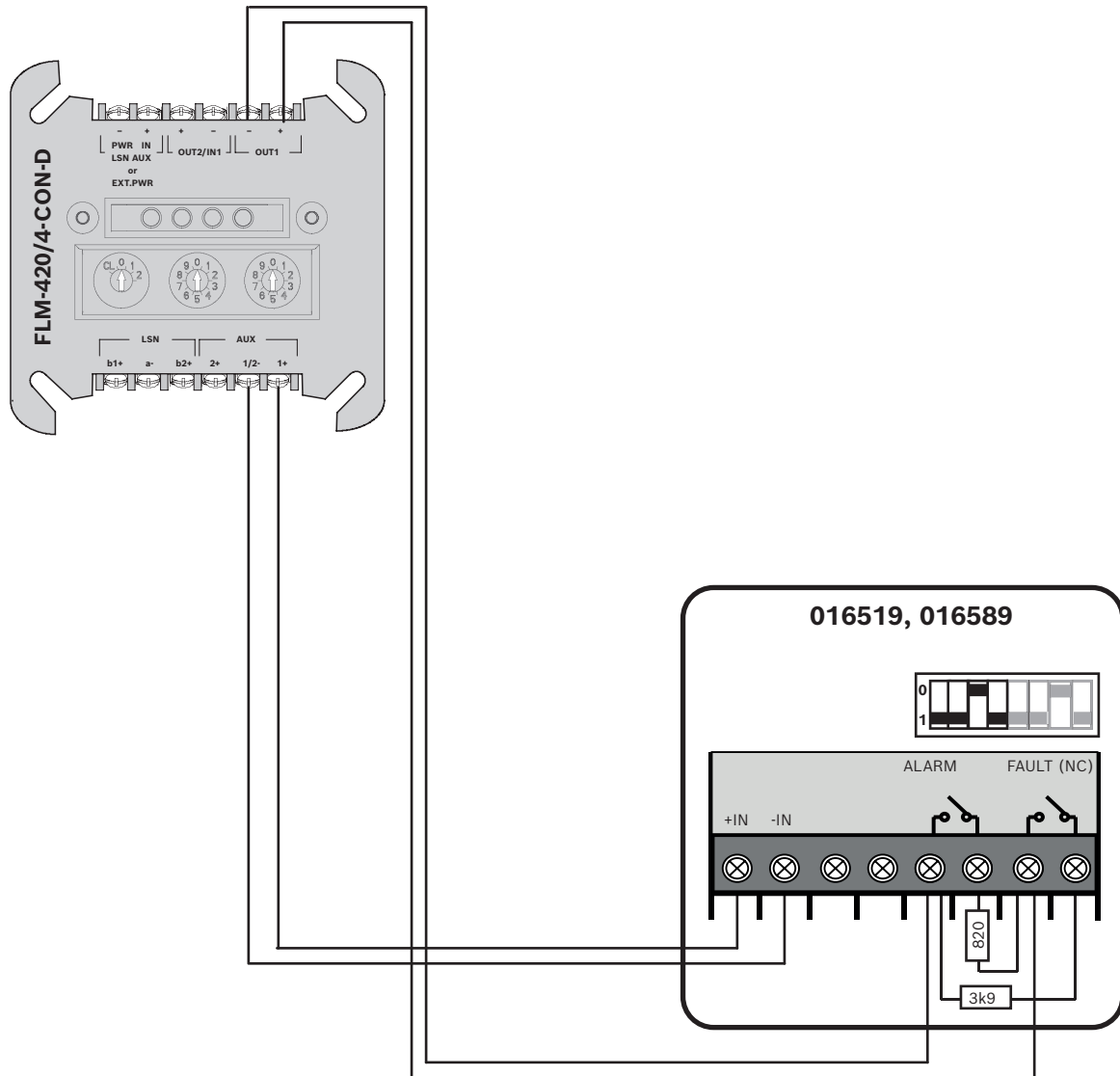
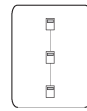

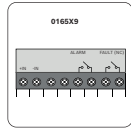

016519, 016589 IR3 Flame Detector

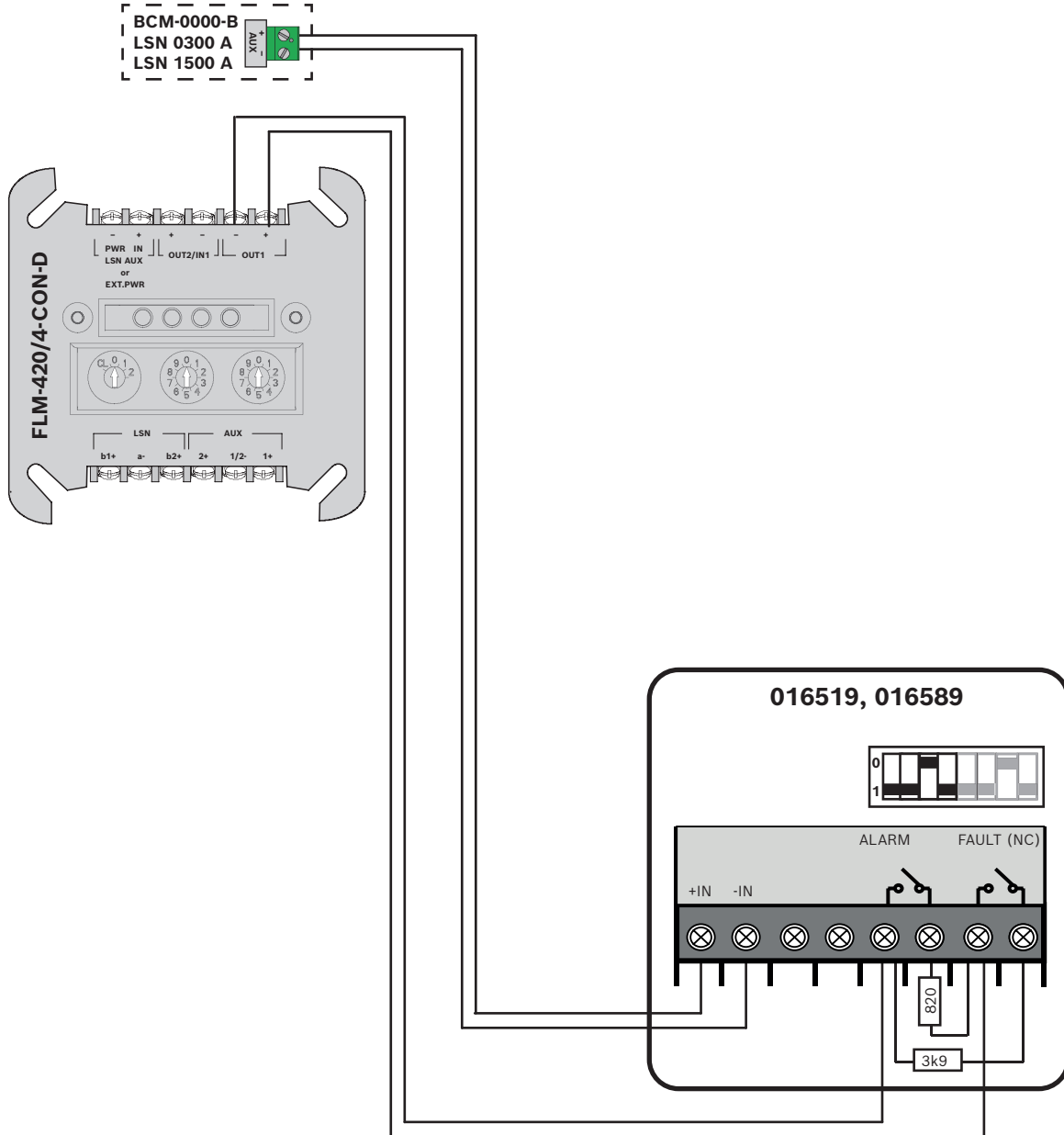
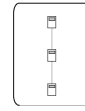

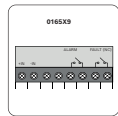

**016519, 016589
IR3 Flame Detector**

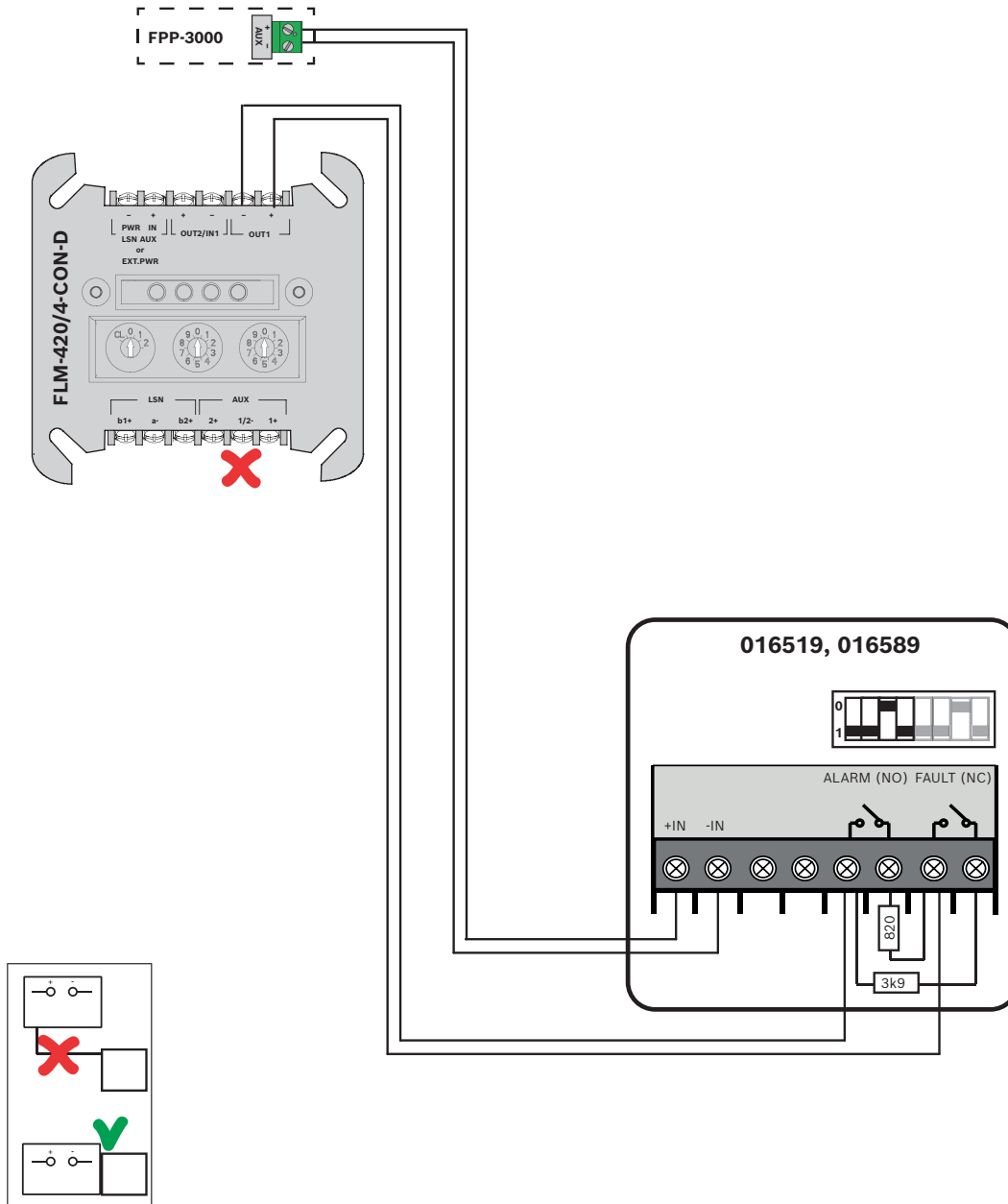



**Fireray 50RV
Fireray 100RV**

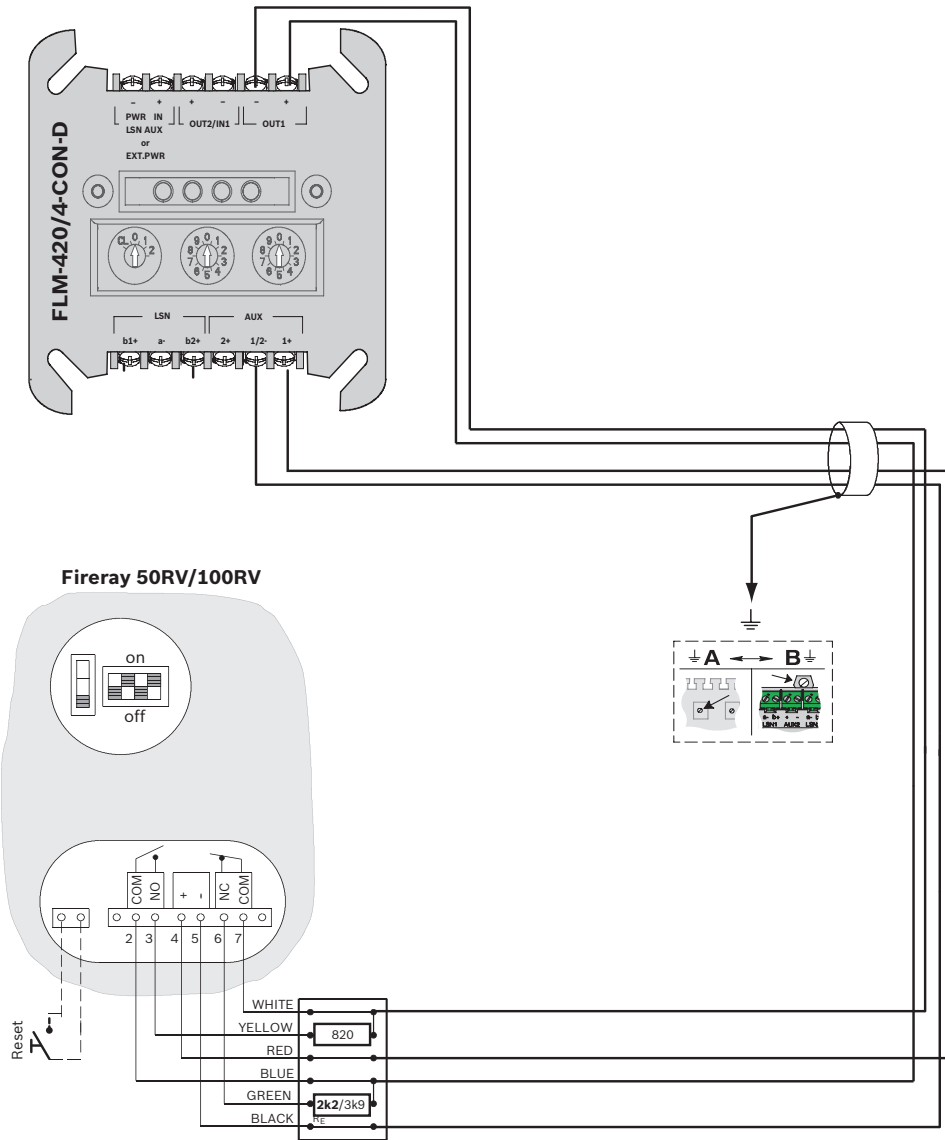



FIRERAY3000

1 x

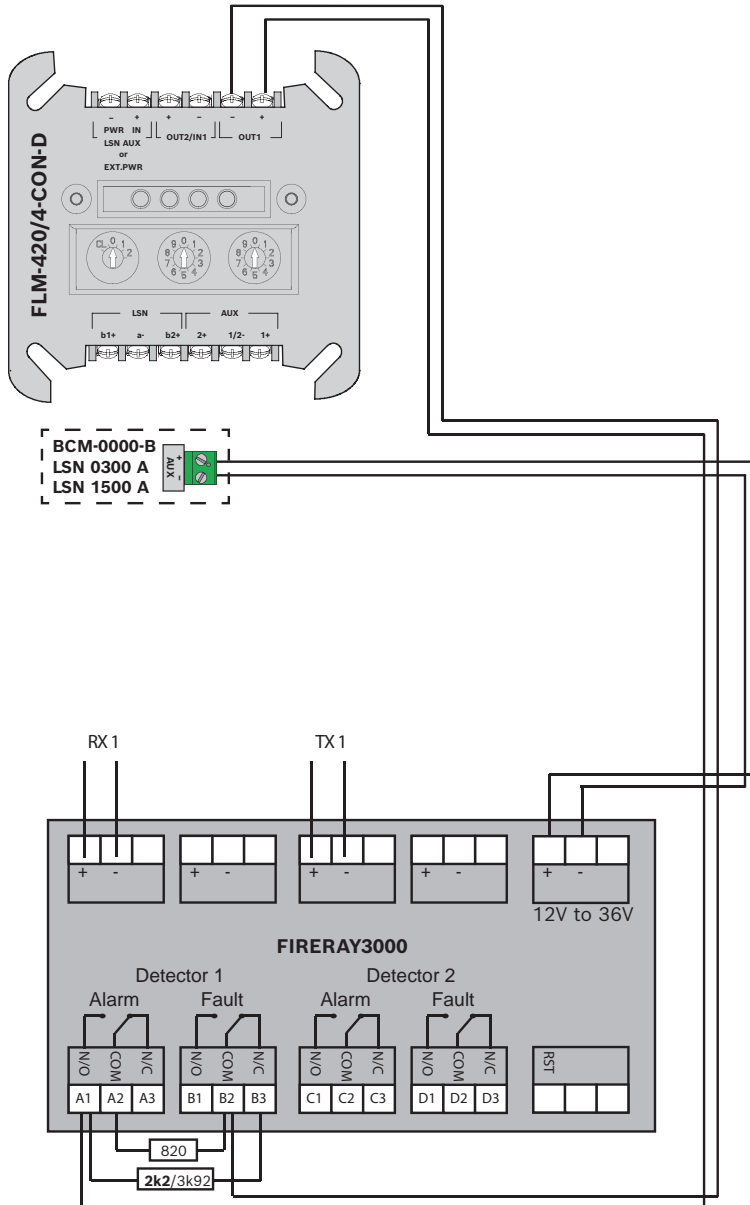



FIRERAY3000

2 x **OUT1**

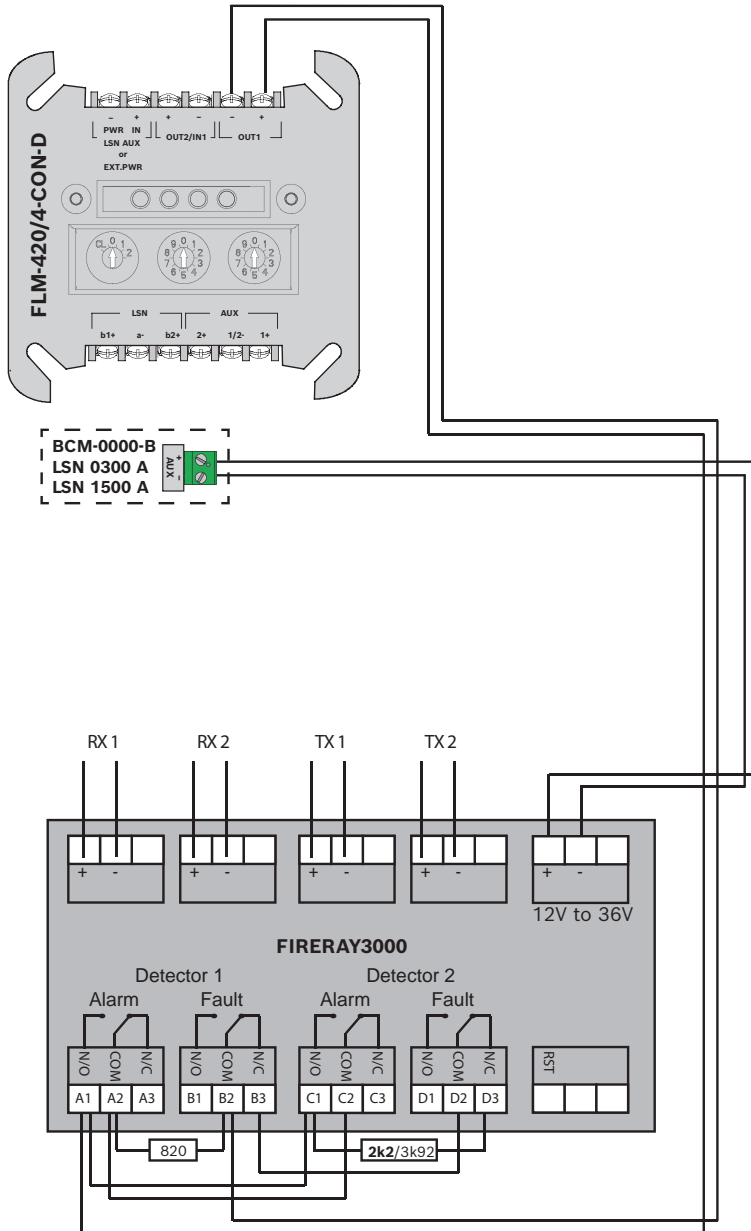



FIRERAY3000

2 x **OUT1+2**

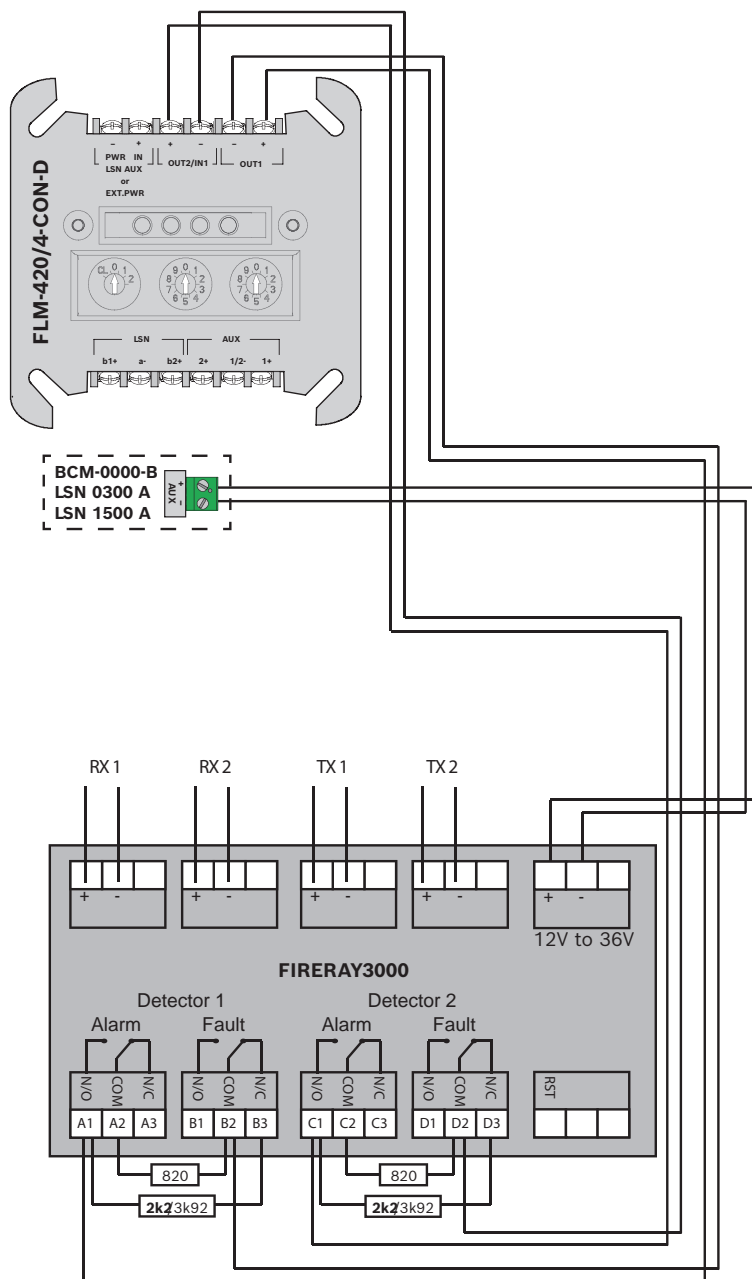

Reset action



FIRERAY5000

1 x

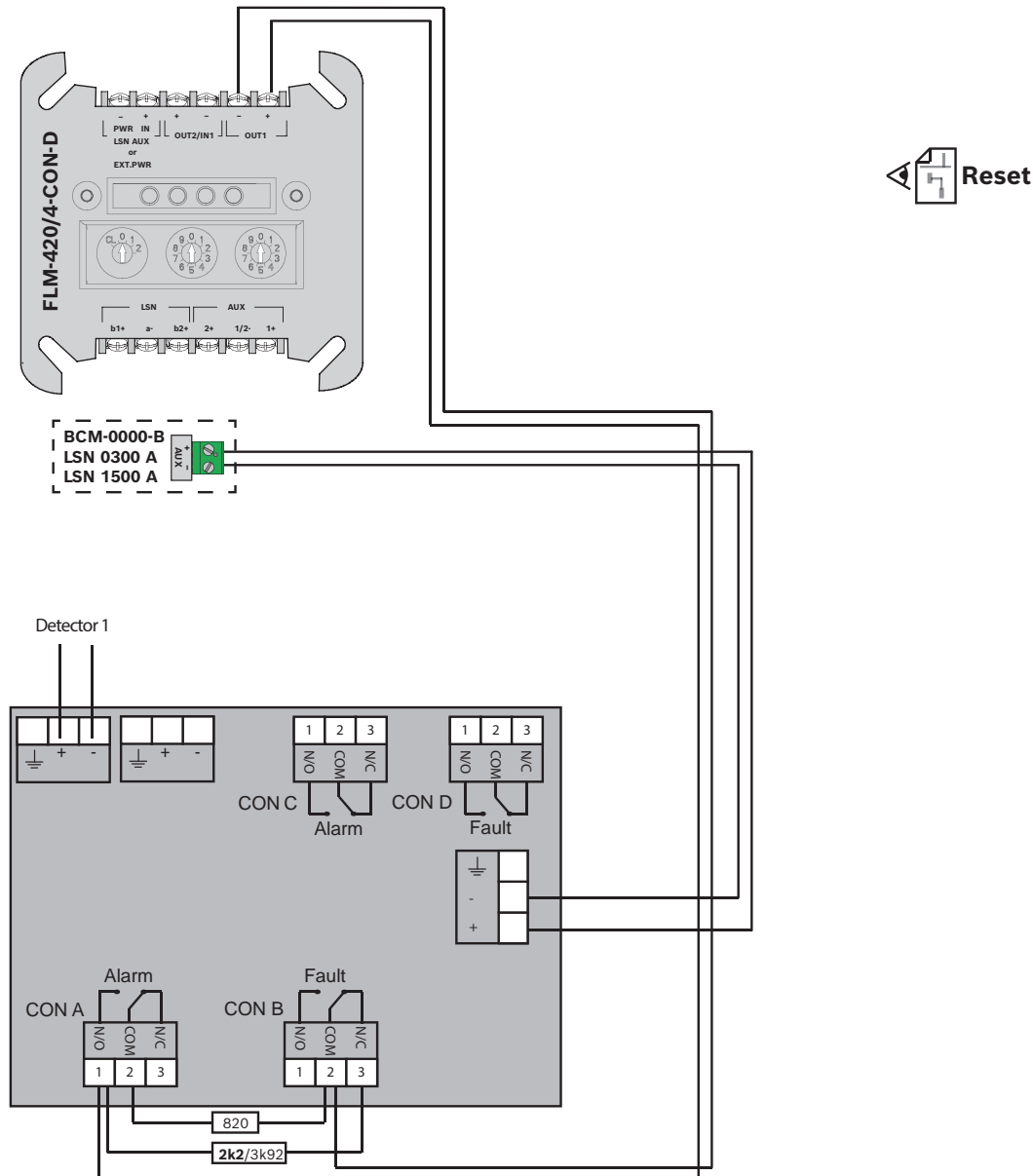

Reset



FIRERAY5000

2 x OUT1

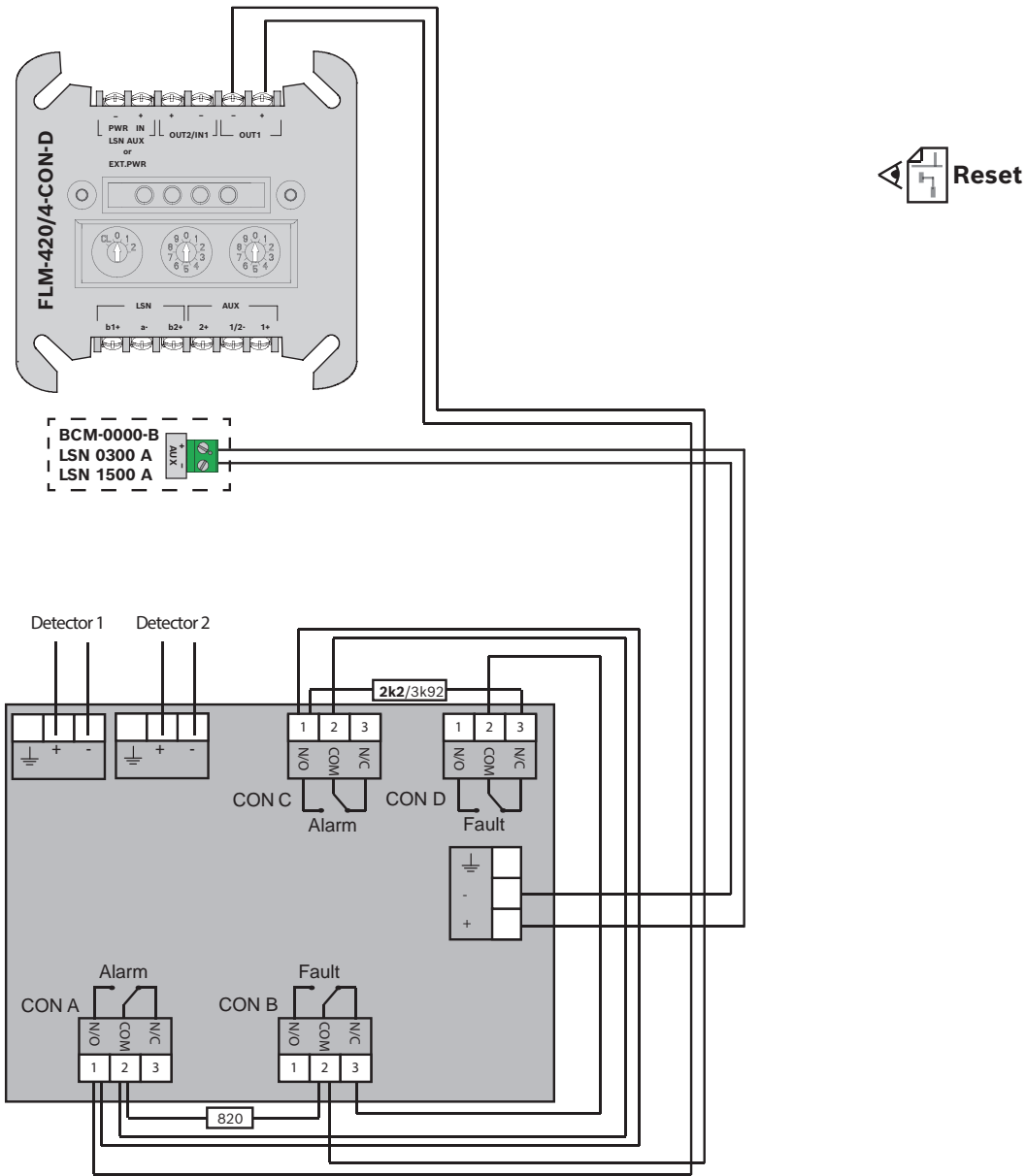

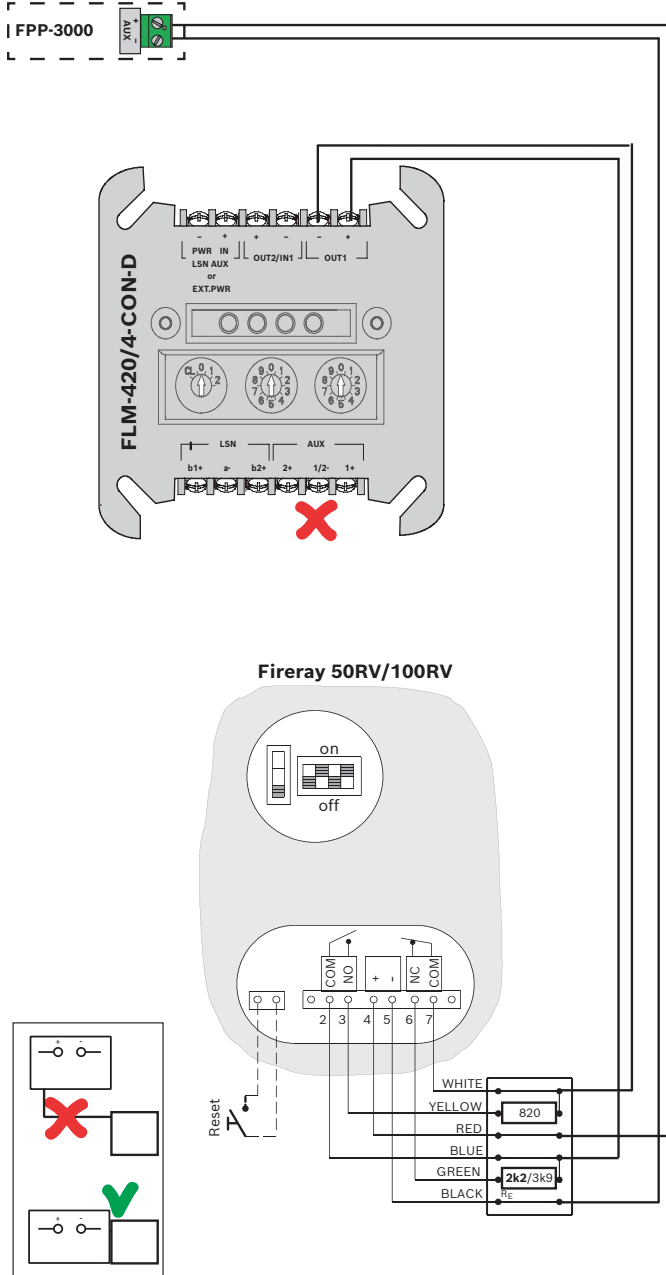



FIRERAY3000

1 x

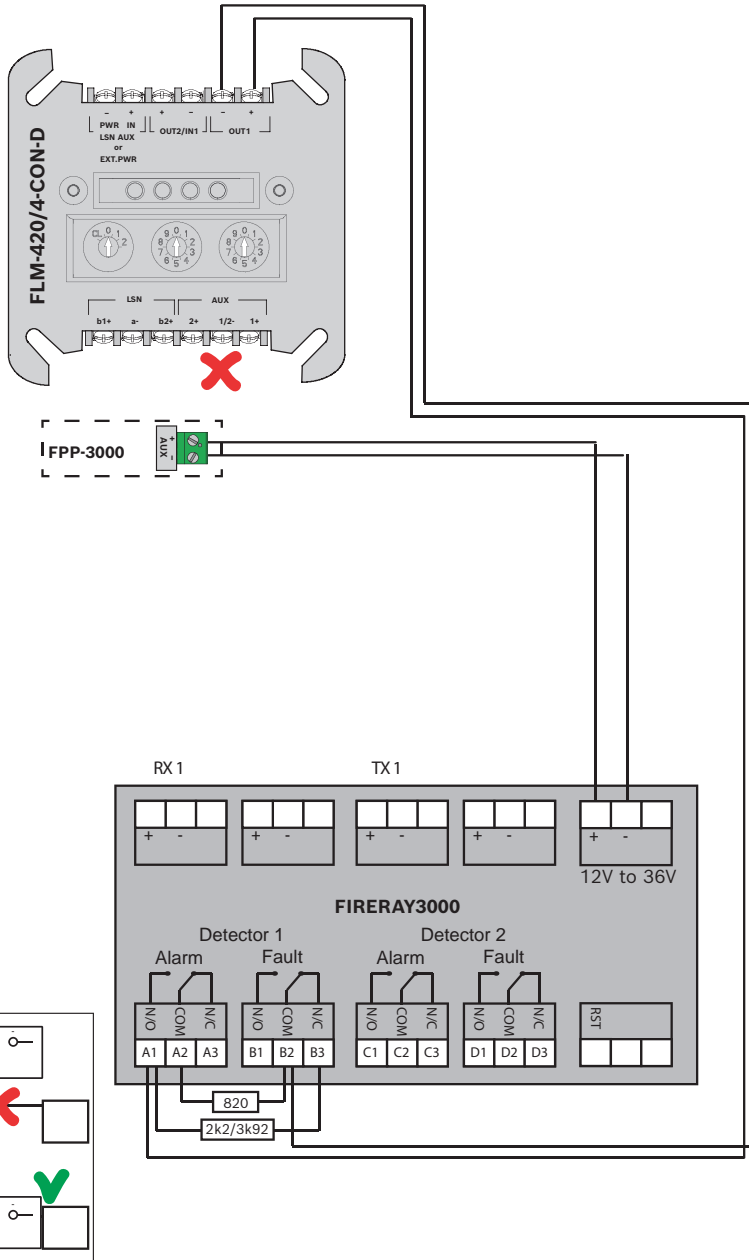

Reset action

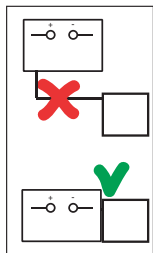

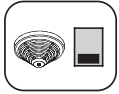

FIRERAY3000

2 x  **OUT1**

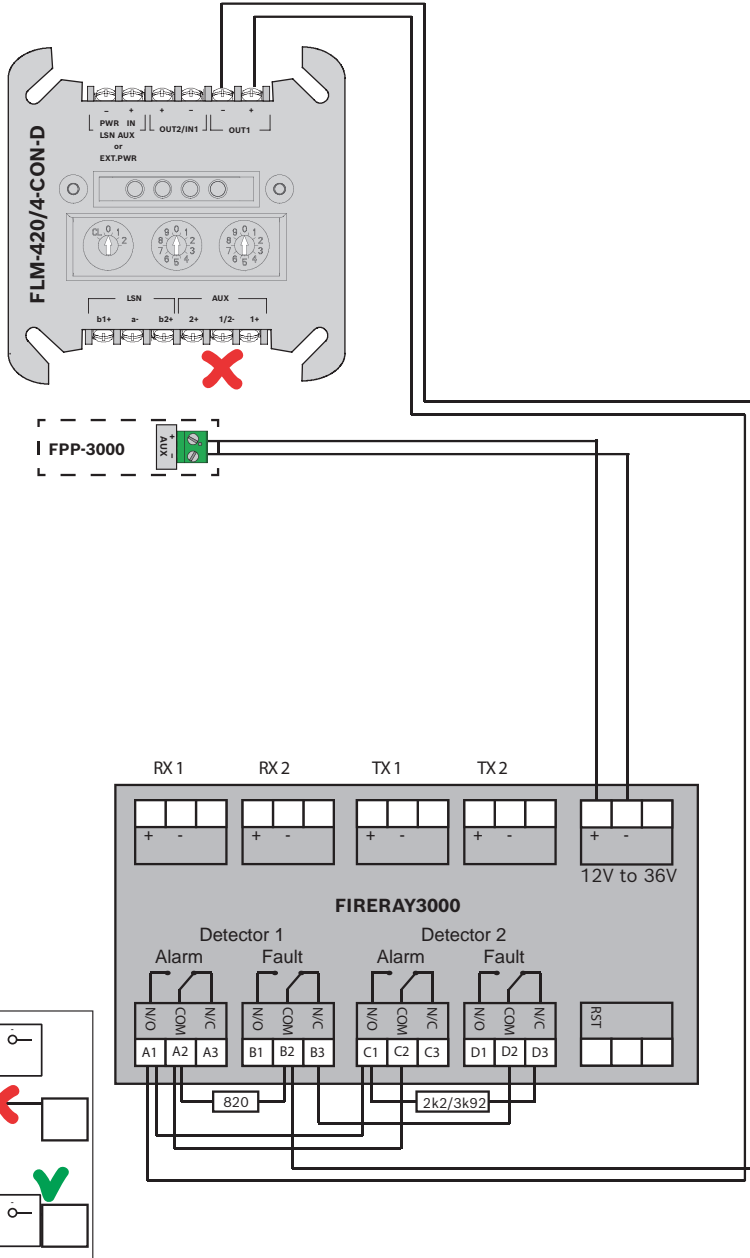

 **Reset action**

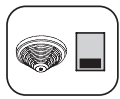

FIRERAY5000

1 x 

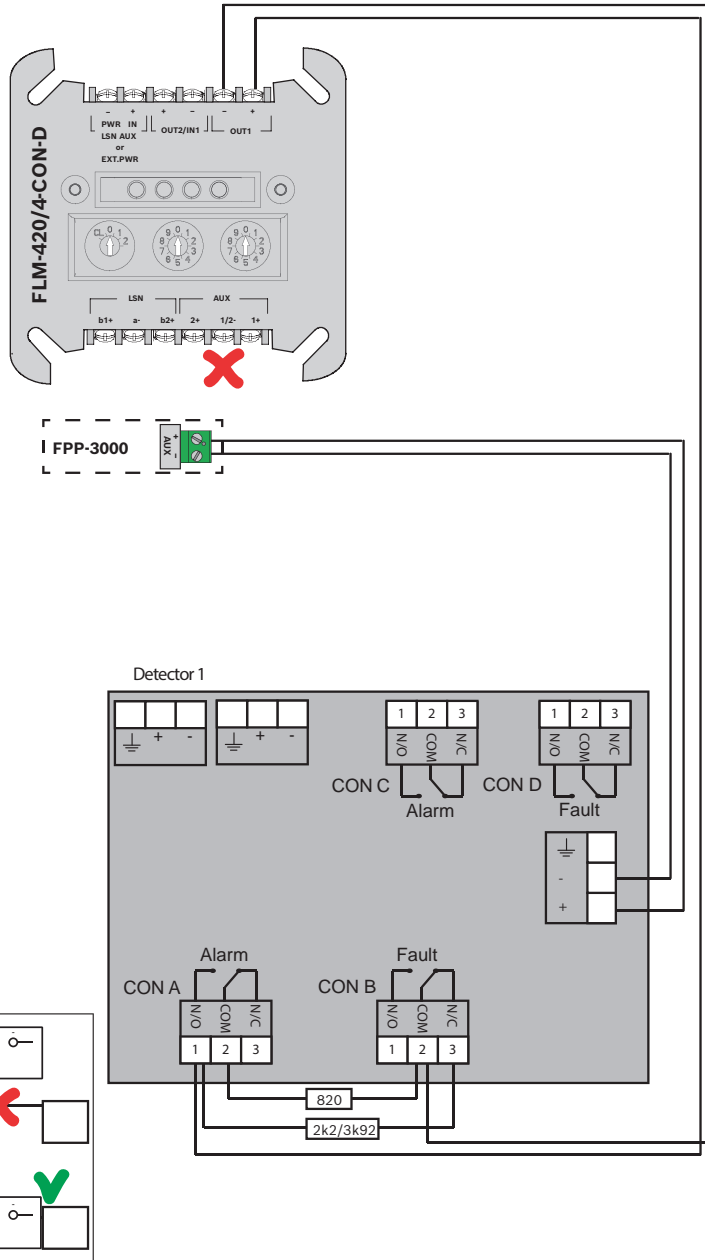

 Reset action



FIRERAY5000

2 x OUT1

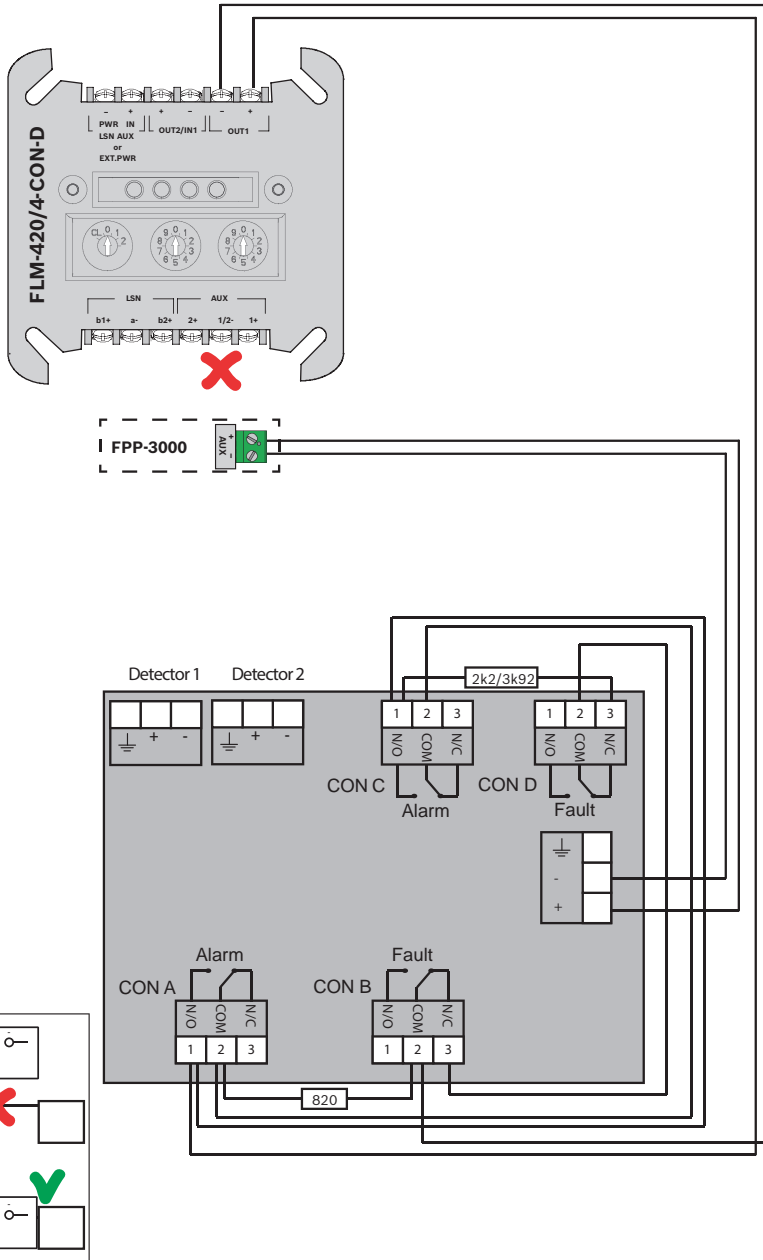

Reset action

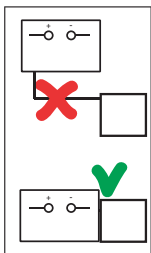

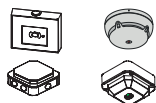

DC1192, SB3
OOH740-A9-Ex
DO1101A-Ex
DT1101A-Ex-
/DT1102A-Ex
DF1101-Ex

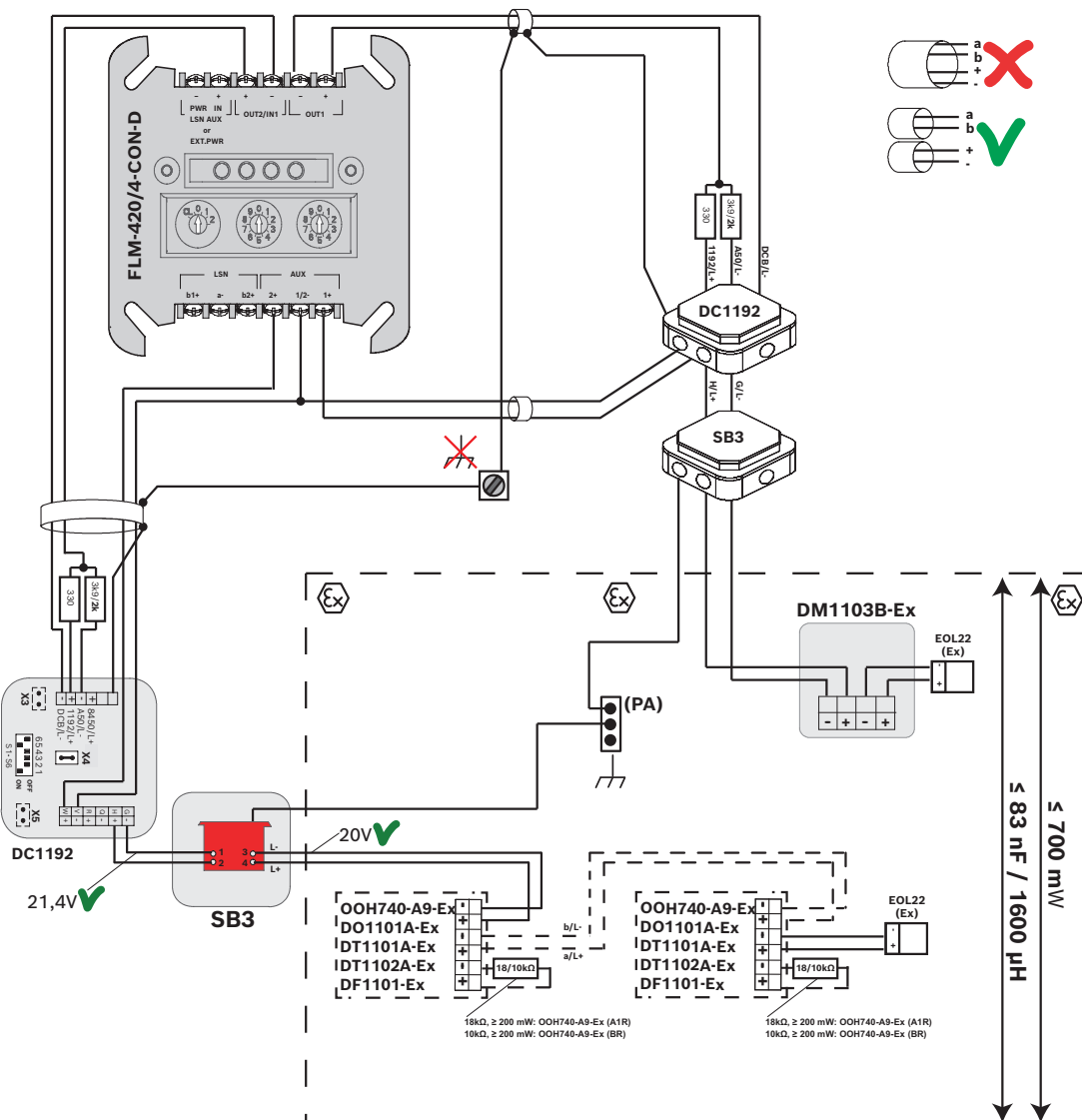



DC1192, SB3
OOH740-A9-Ex
DO1101A-Ex
DT1101A-Ex/DT1102A-Ex
DF1101-Ex
DM1103B-Ex

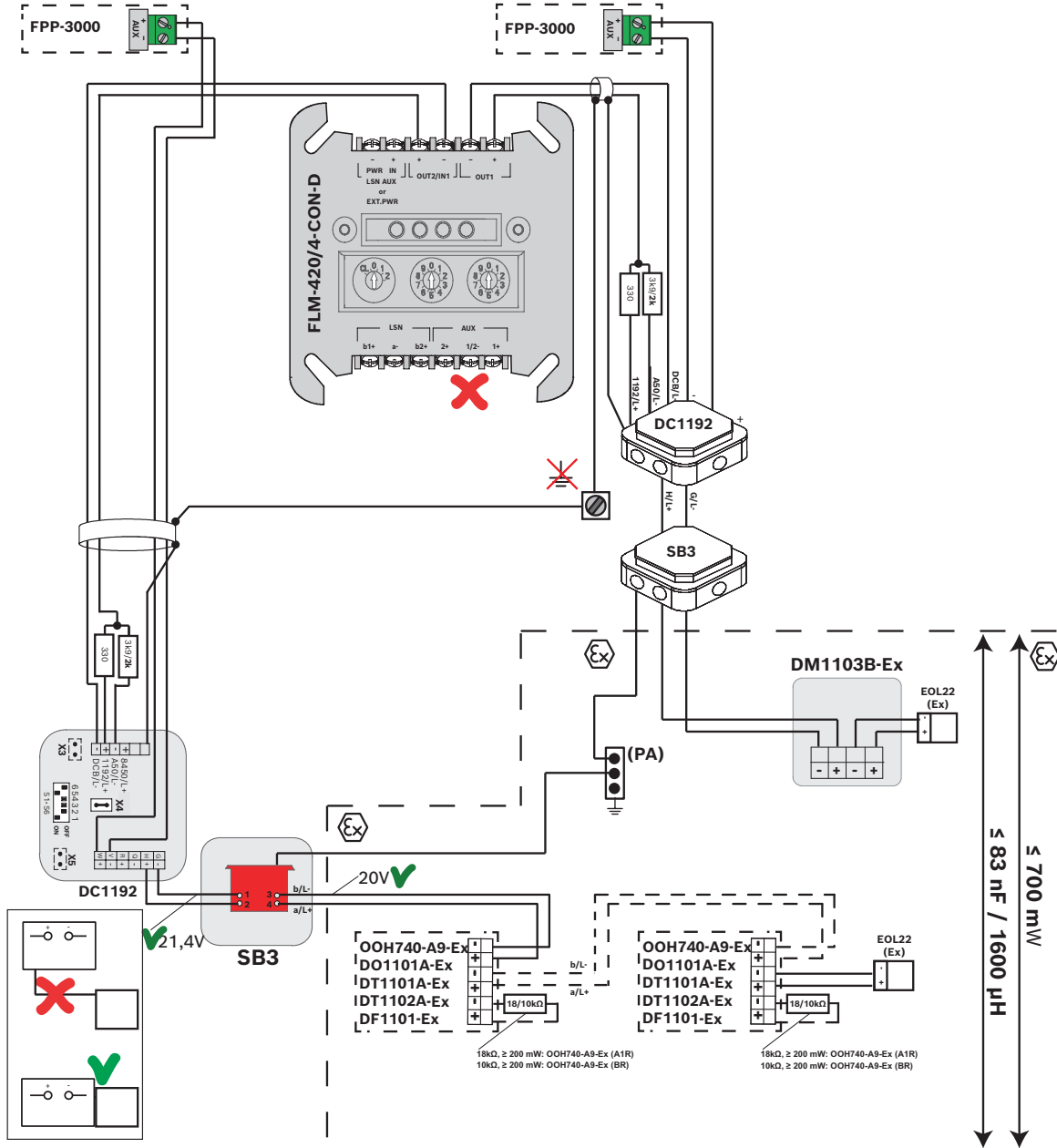

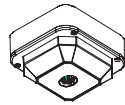

DF 1192

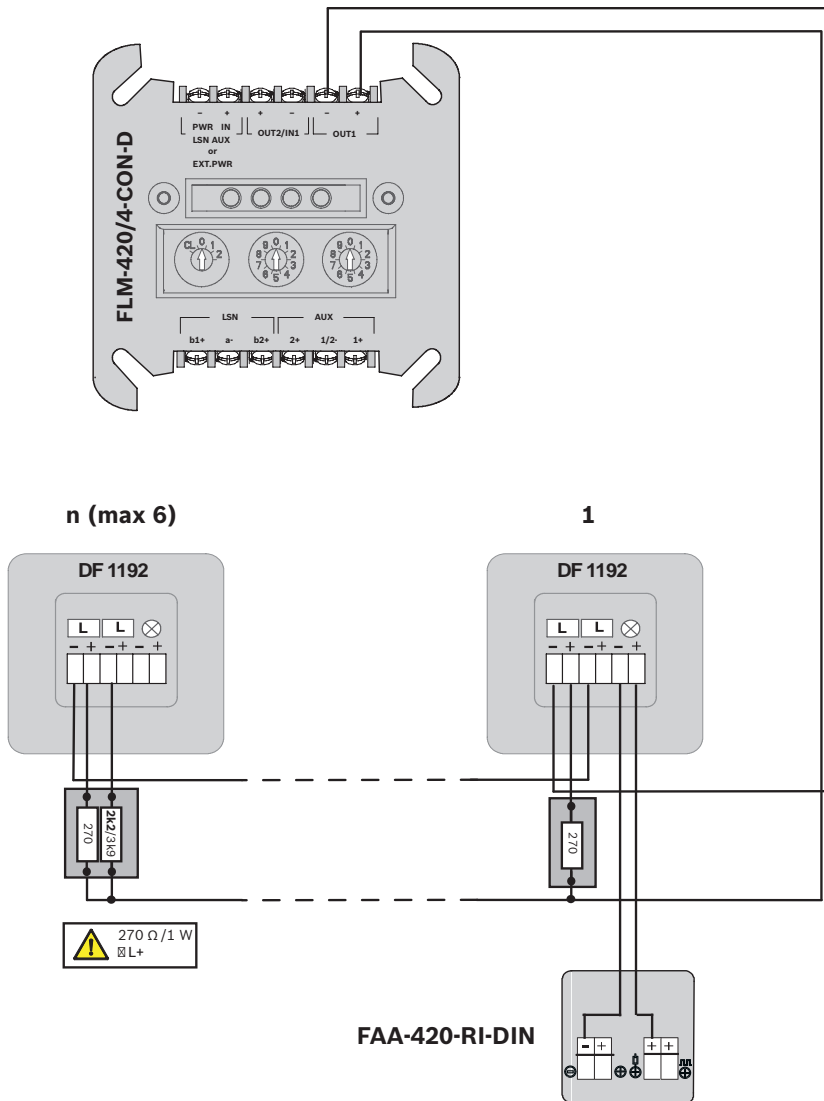

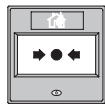
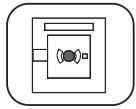

FMC-300-RW

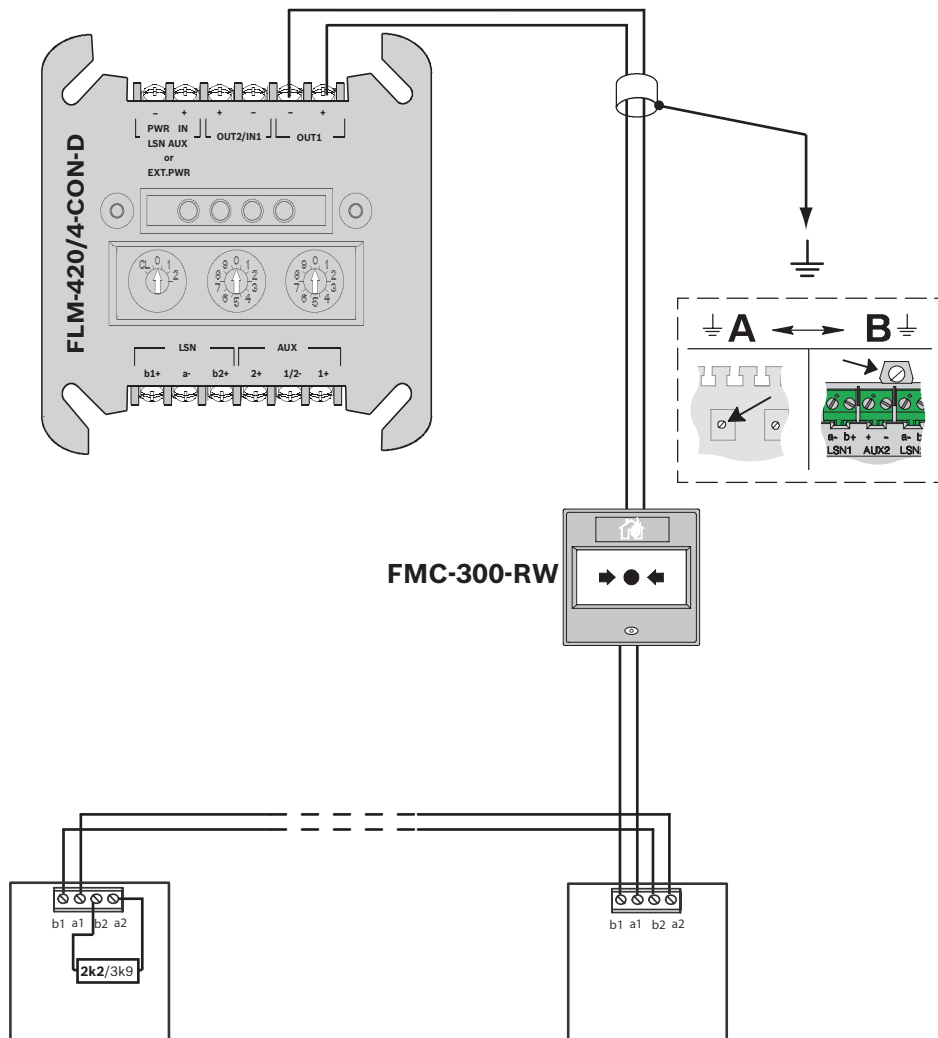
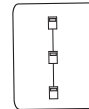

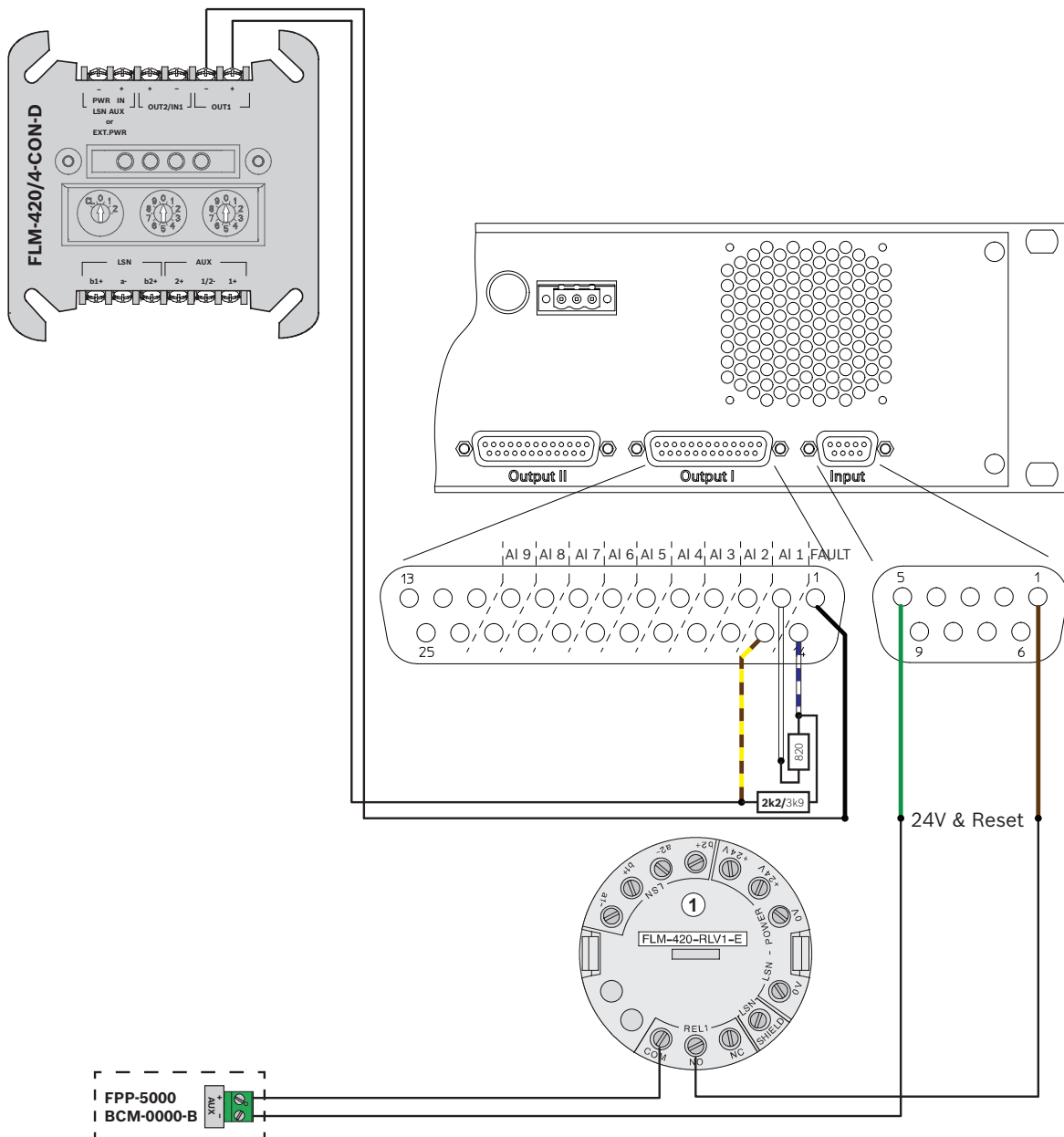

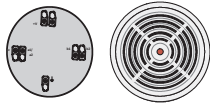

MSS 400, MSS 400 B
 FCH-320-T320
 FCH-T320-R470, FCH-T320-FSA
 FCP-O320, FCP-O320-R470
 FCP-OC320, FCP-OC320-R470
 FCP-OT320, FCP-OT320-R470

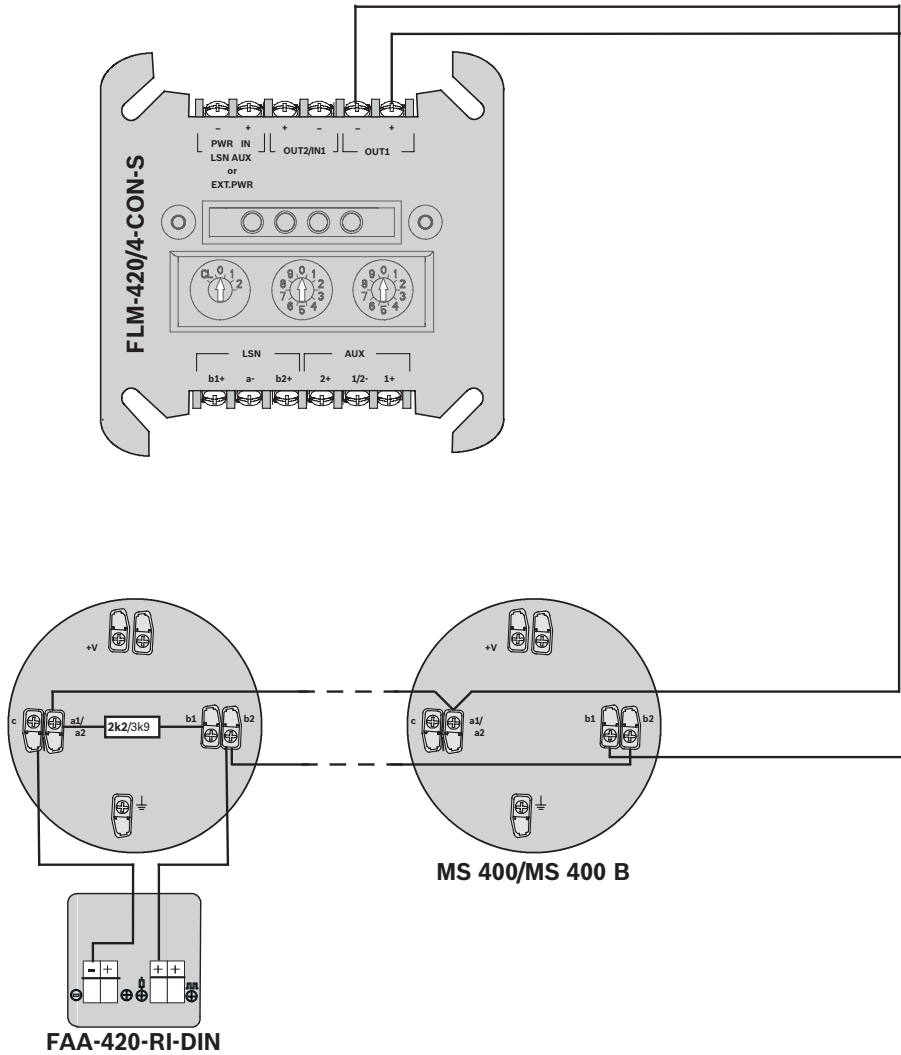

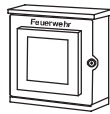
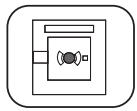

2014/2 Ex
2014/2 GLU-Ex

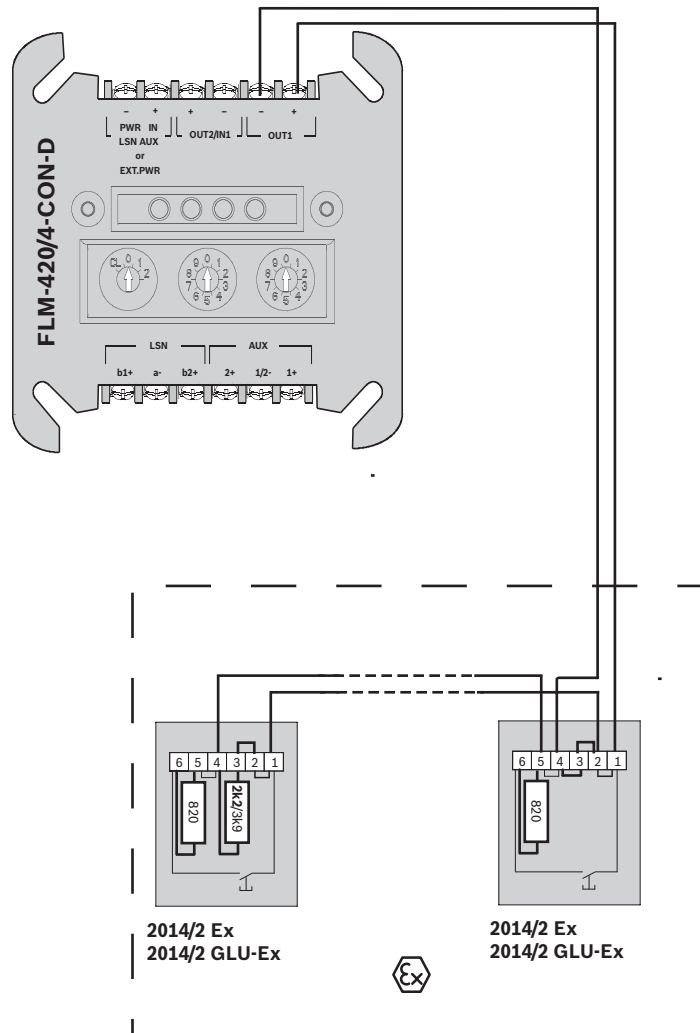
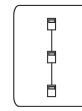

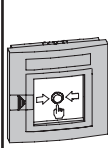
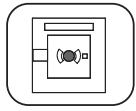

FMC-120-DKM-G-R FMC-120-DKM-G-Y
FMC-120-DKM-H-R FMC-120-EST-G-B
FMC-120-DKM-G-B
FMC-120-DKM-H-B

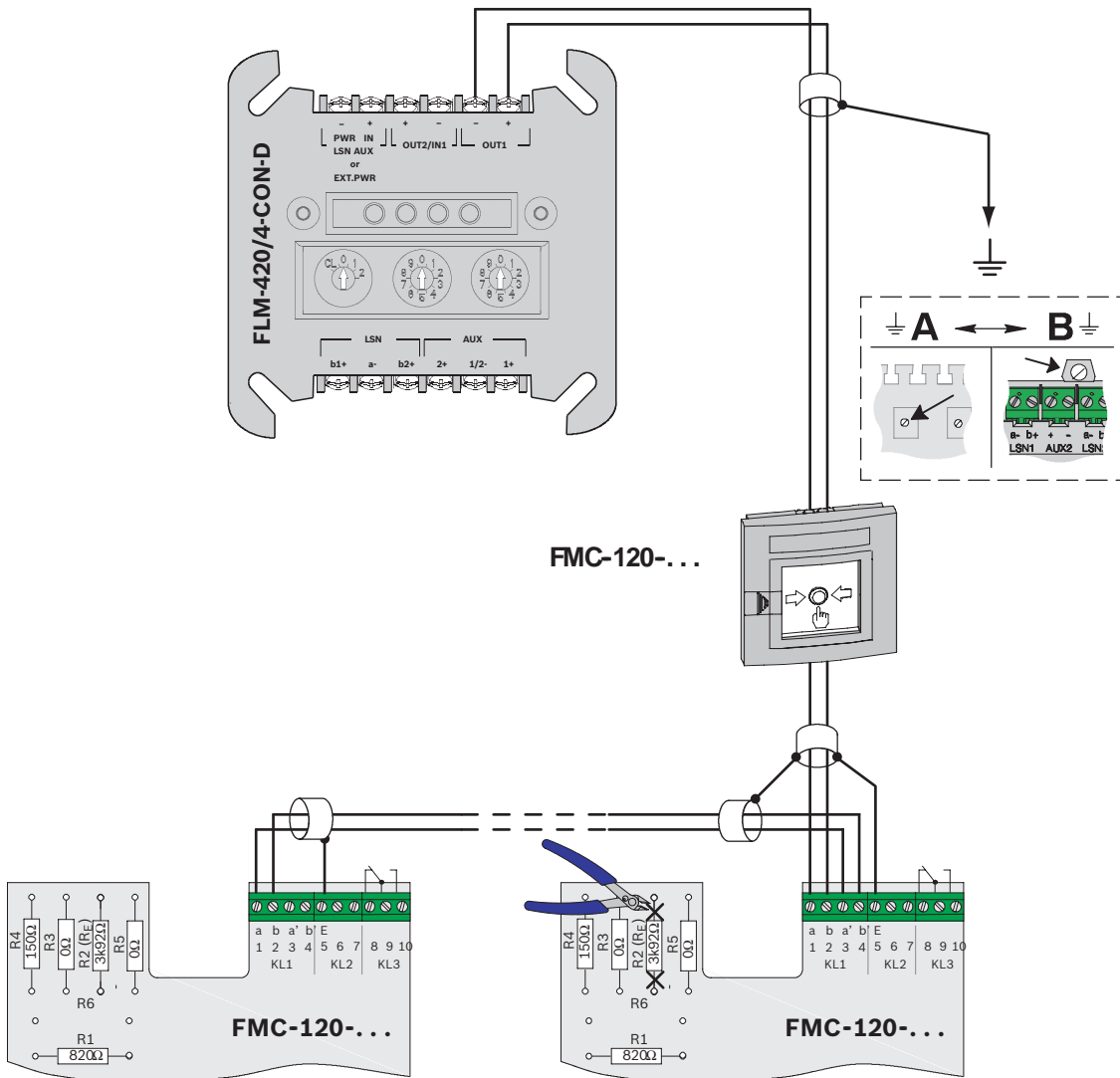
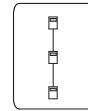

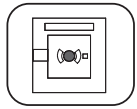

NO

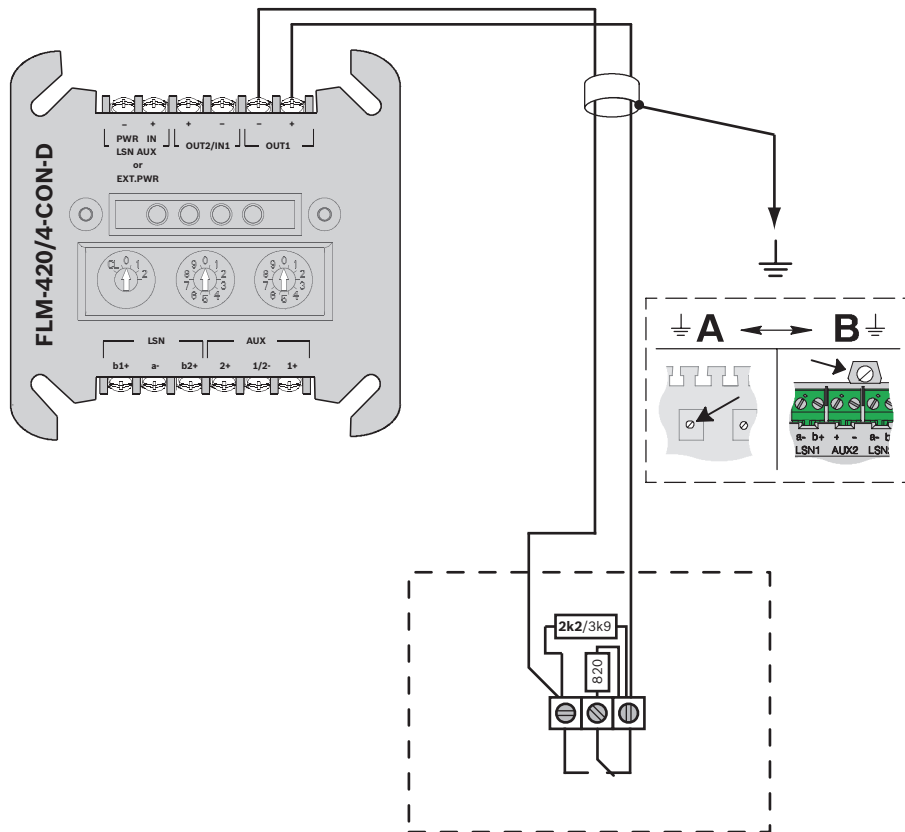
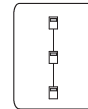

2.5.2

FLM-420-I8R1-S

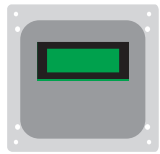

ProReact EN Analogue

FCS-LHD-2EN



FPP-5000
BCM-0000-B

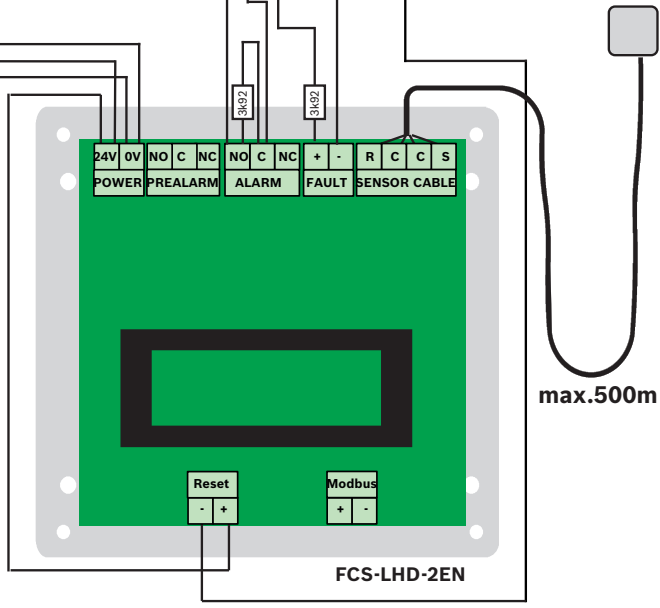
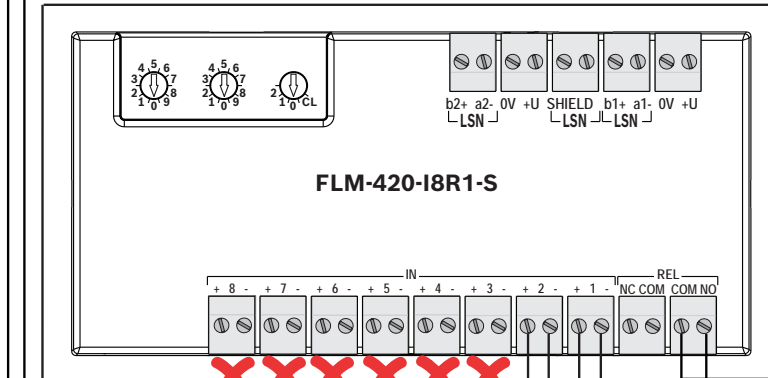

max.500m

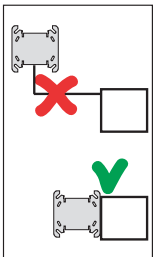

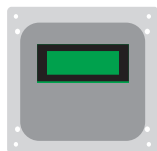

ProReact EN Analogue

FCS-LHD-2EN



ELS

FPP-3000(ZSP135-DR)
FPP-5000
BCM-0000-B

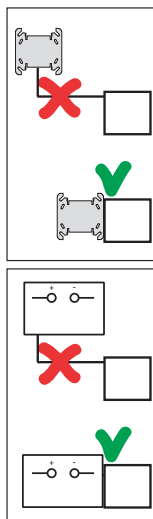
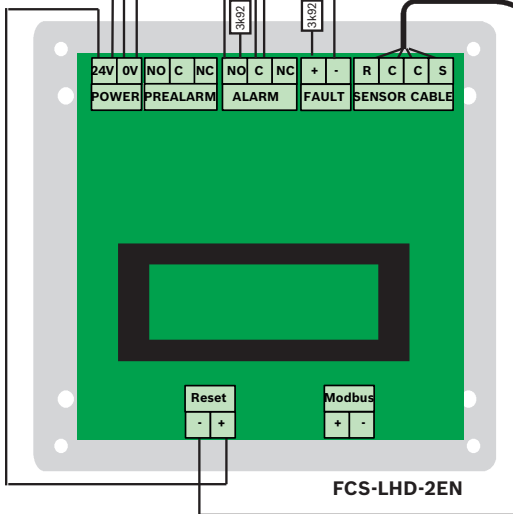
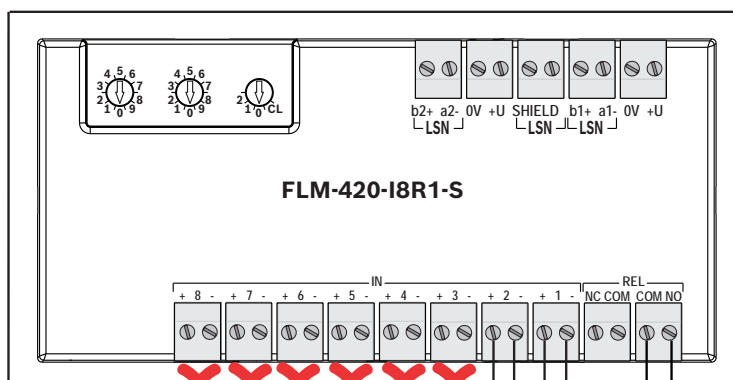

2.5.3 FLM-420-NAC-D/S

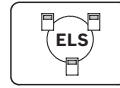

FPP-3000(ZSP135-DR)
 FPP-5000
 BCM-0000-B

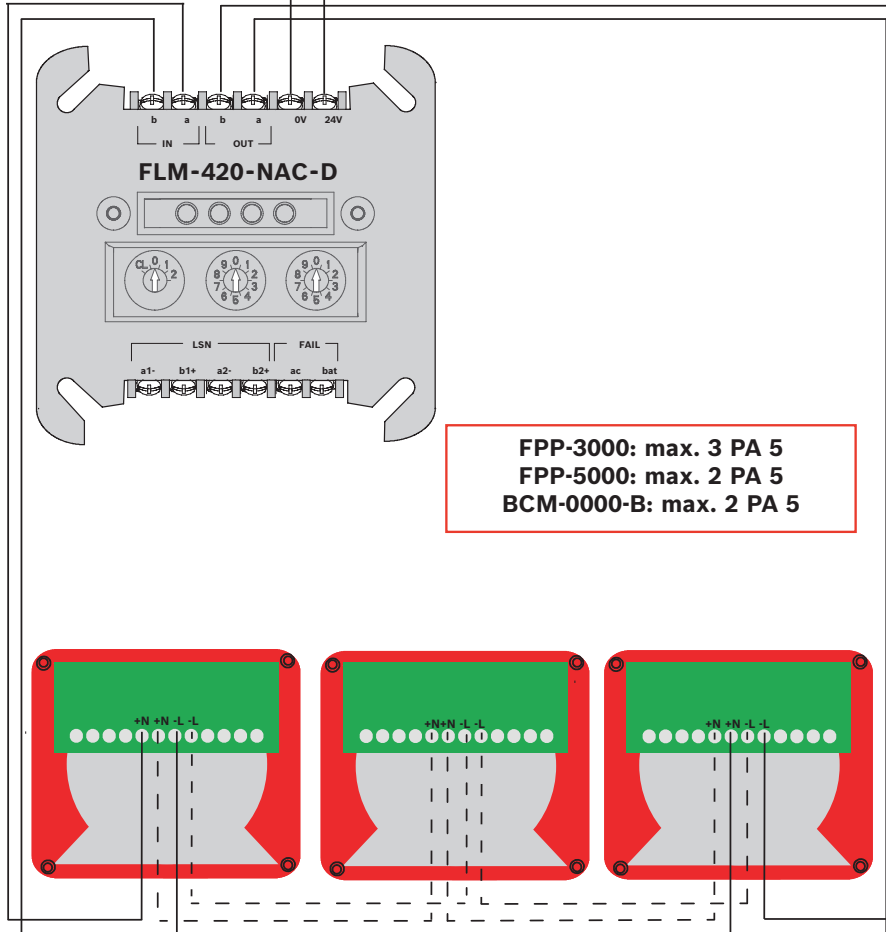

FPP-3000: max. 3 PA 5
FPP-5000: max. 2 PA 5
BCM-0000-B: max. 2 PA 5

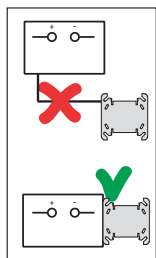



FPP-3000
FPP-5000
BCM-0000-B

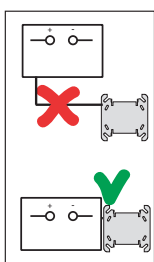
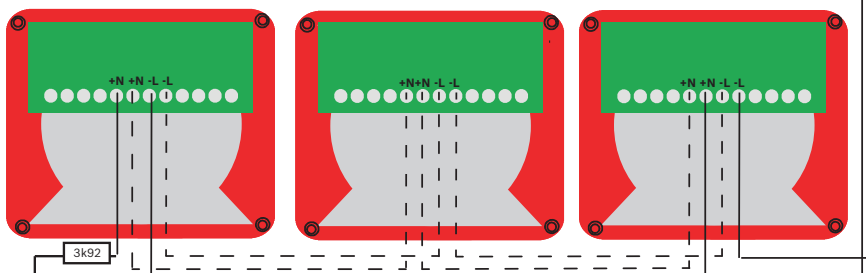
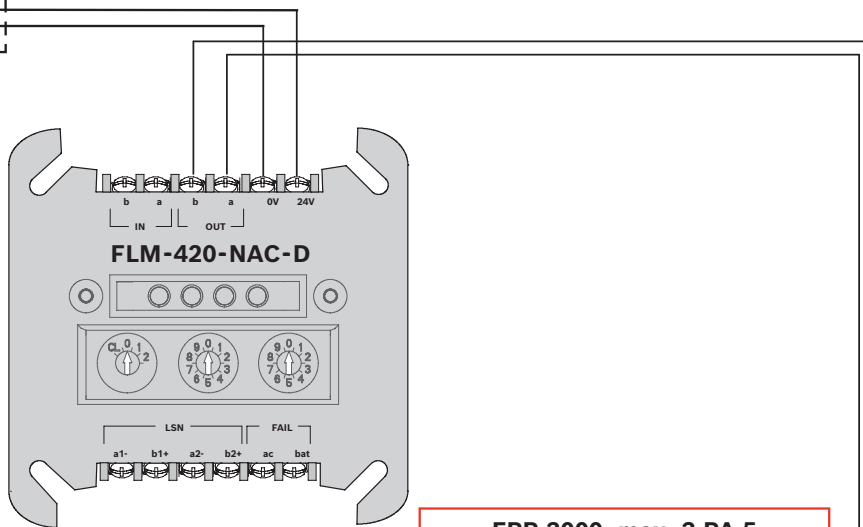

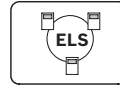

FPP-3000(ZSP135-DR)
FPP-5000
BCM-0000-B

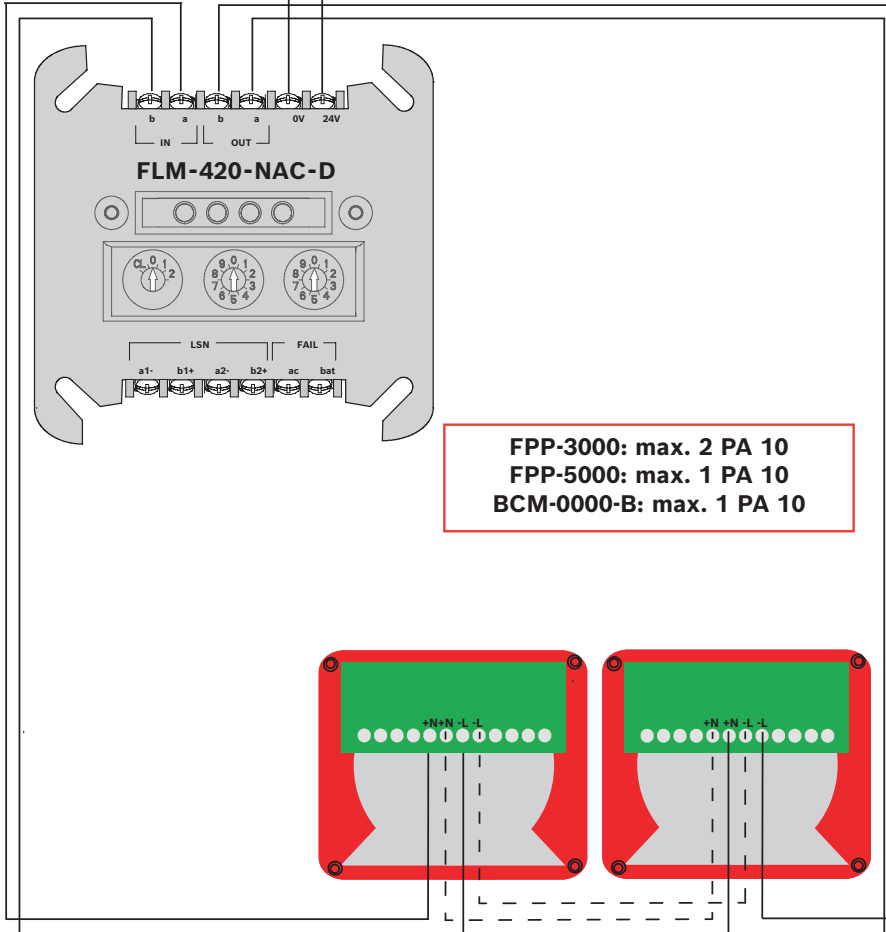

FPP-3000: max. 2 PA 10
FPP-5000: max. 1 PA 10
BCM-0000-B: max. 1 PA 10

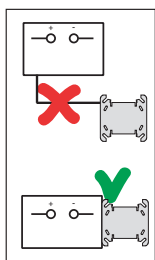



FPP-3000
FPP-5000
BCM-0000-B

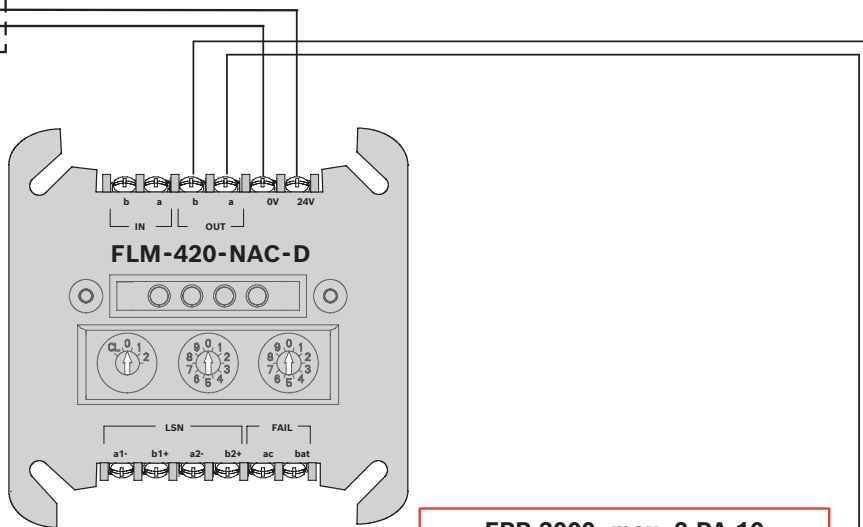

FPP-3000: max. 2 PA 10
FPP-5000: max. 1 PA 10
BCM-0000-B: max. 1 PA 10

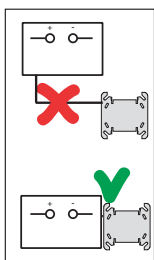
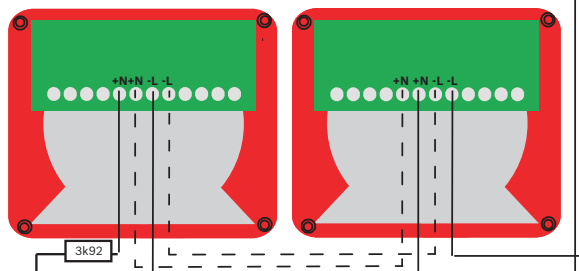

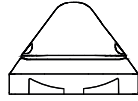

PY X-M-10-SSM R
PY X-M-10-SSM W

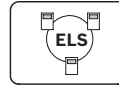

FPP-3000(ZSP-135-DR)
FPP-5000
BCM-0000-B

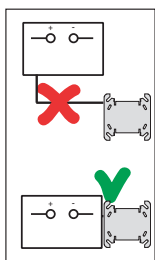
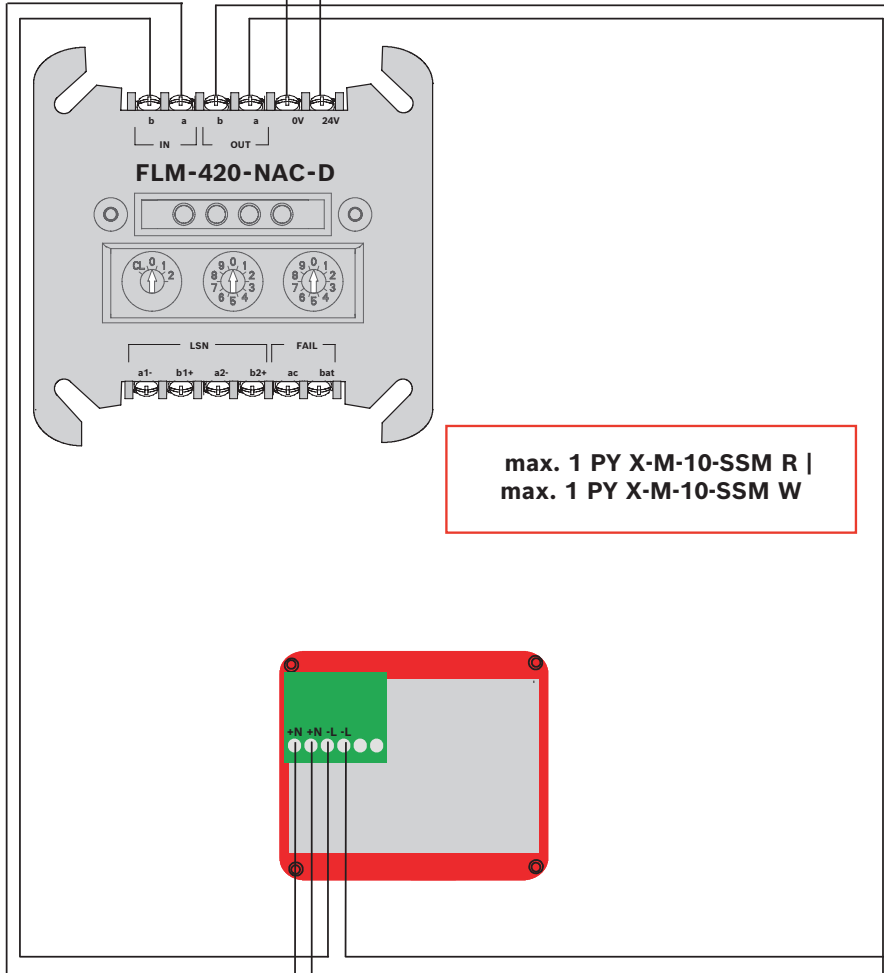

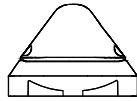

PY X-M-10-SSM R
PY X-M-10-SSM W



FPP-3000
FPP-5000
BCM-0000-B

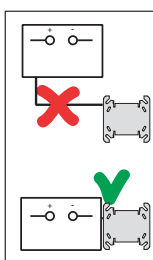
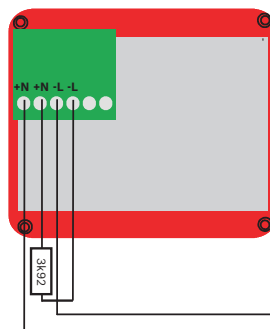
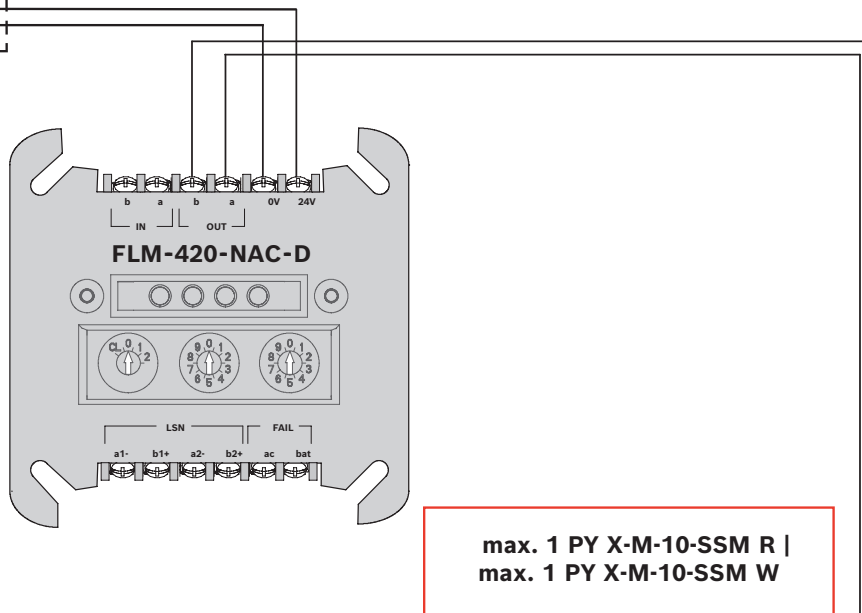



PB 2005

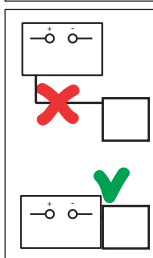
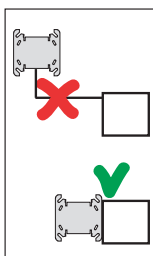
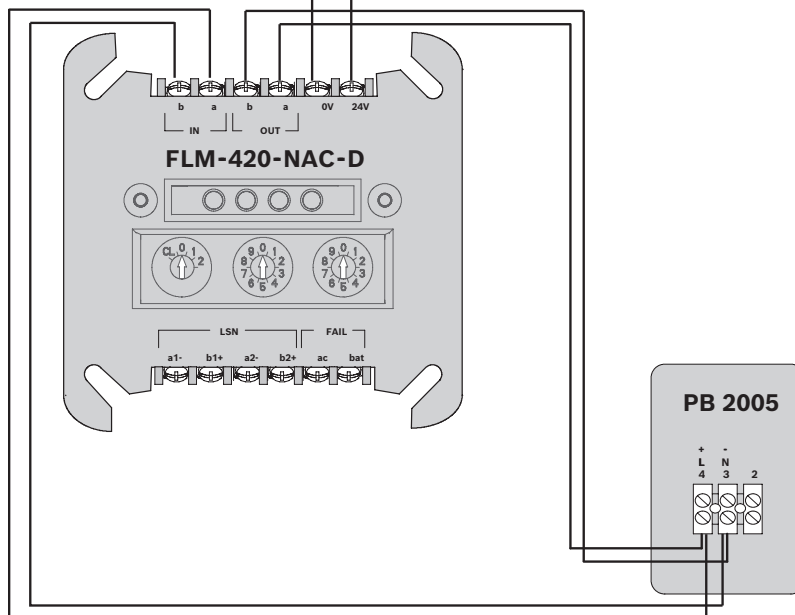
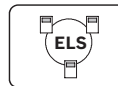



PB 2005



FPP-5000
BCM-0000-B

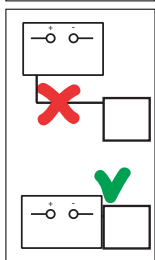
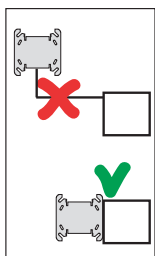
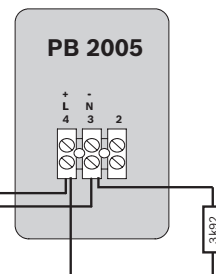
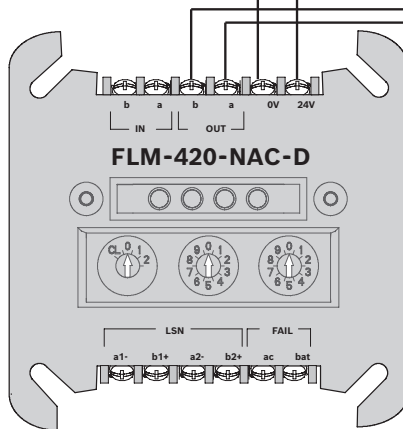

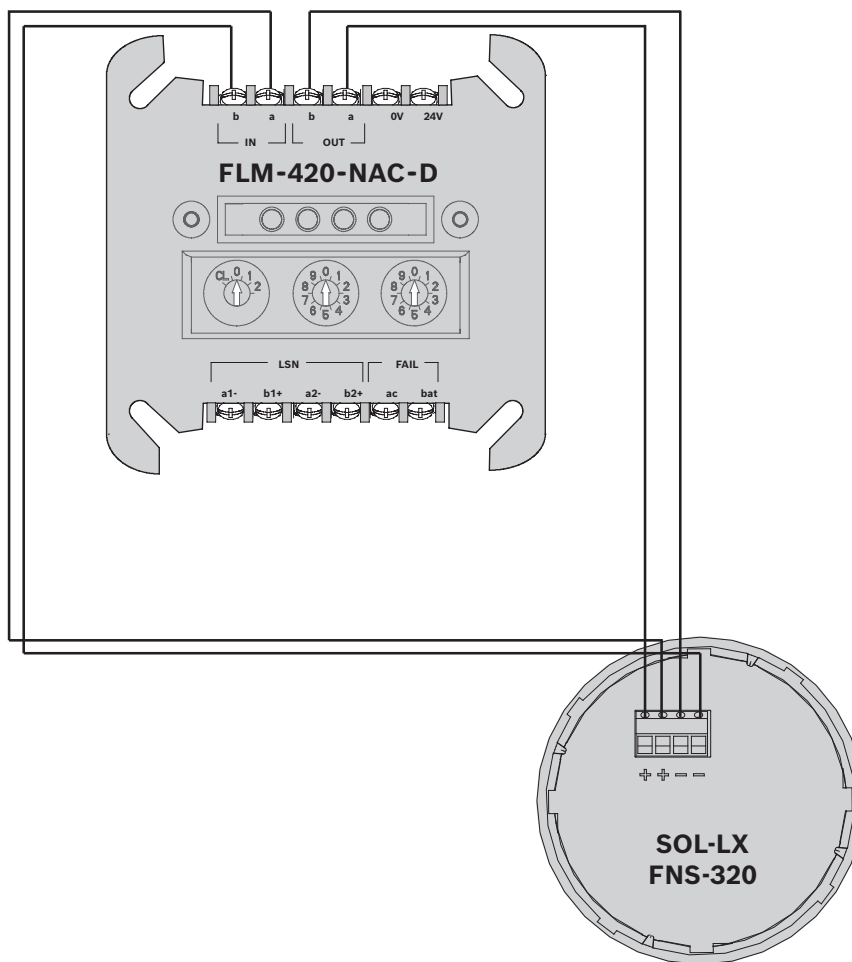
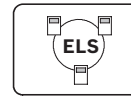

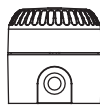

**SOL-LX
FNS-320**

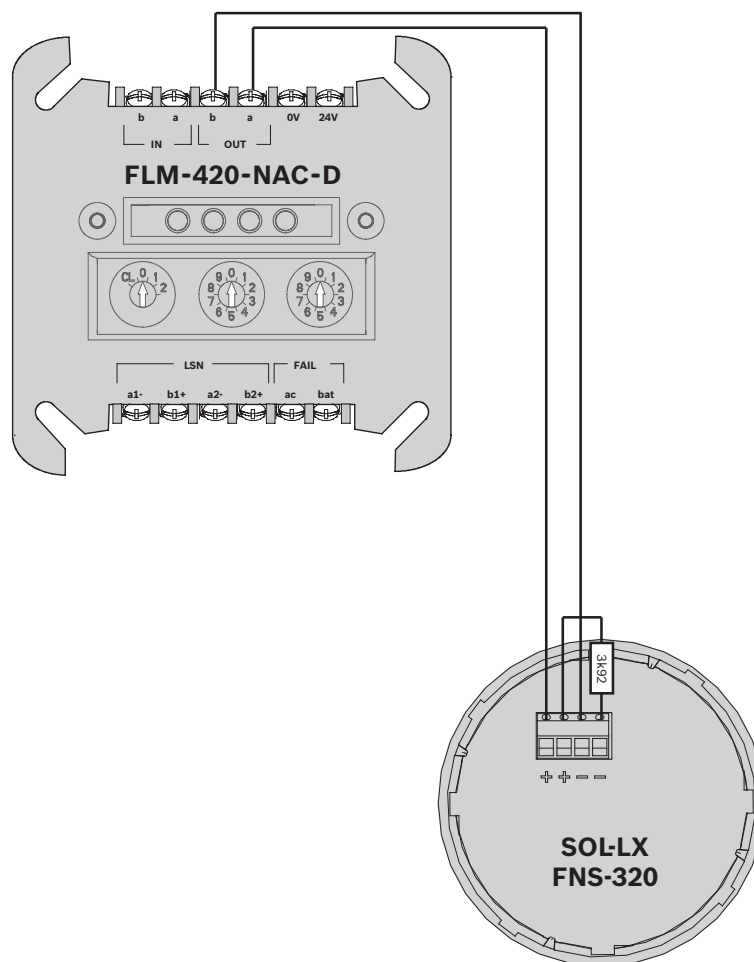
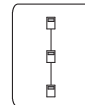

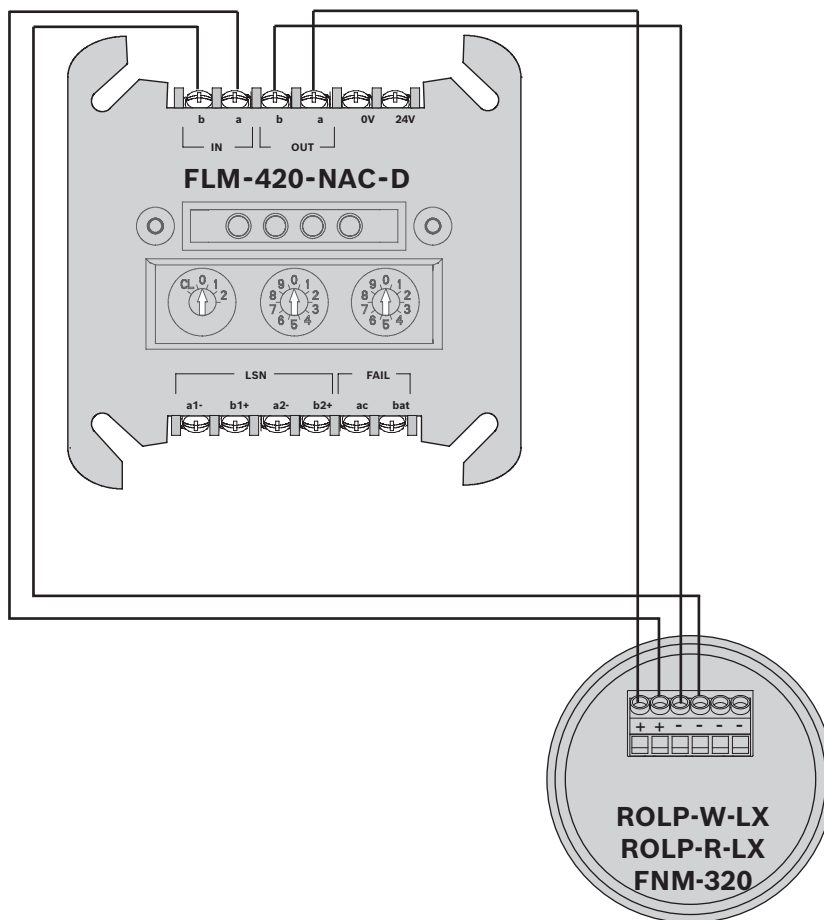
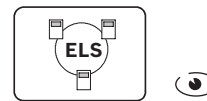

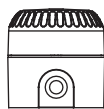
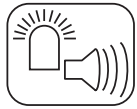

ROLP-W-LX
ROLP-R-LX
FNM-320

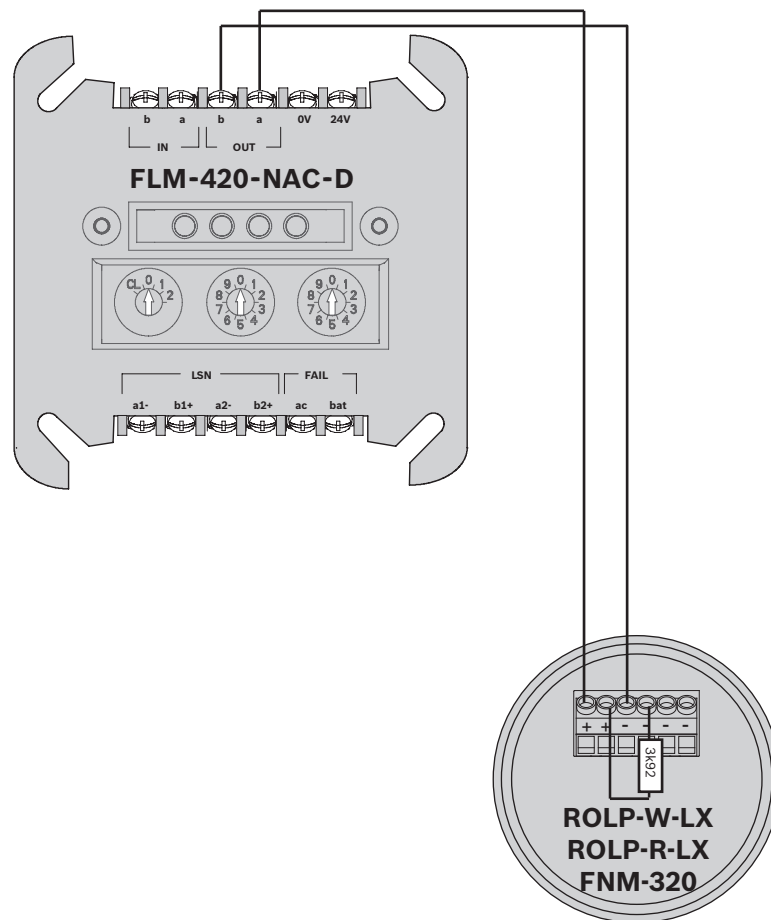
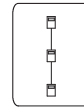

2.5.4 FLM-420-RHV

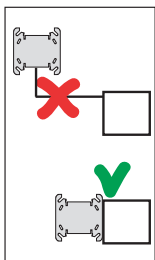
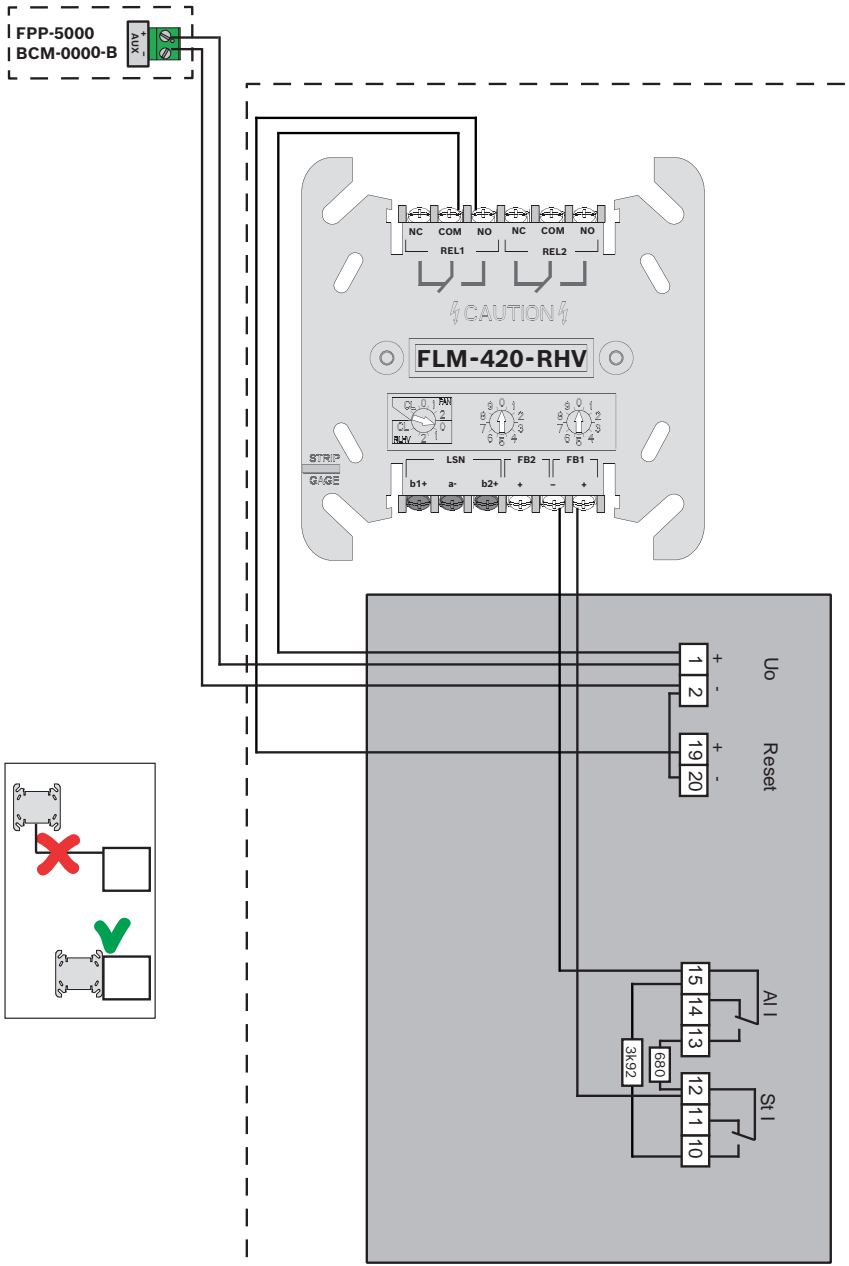



ELS

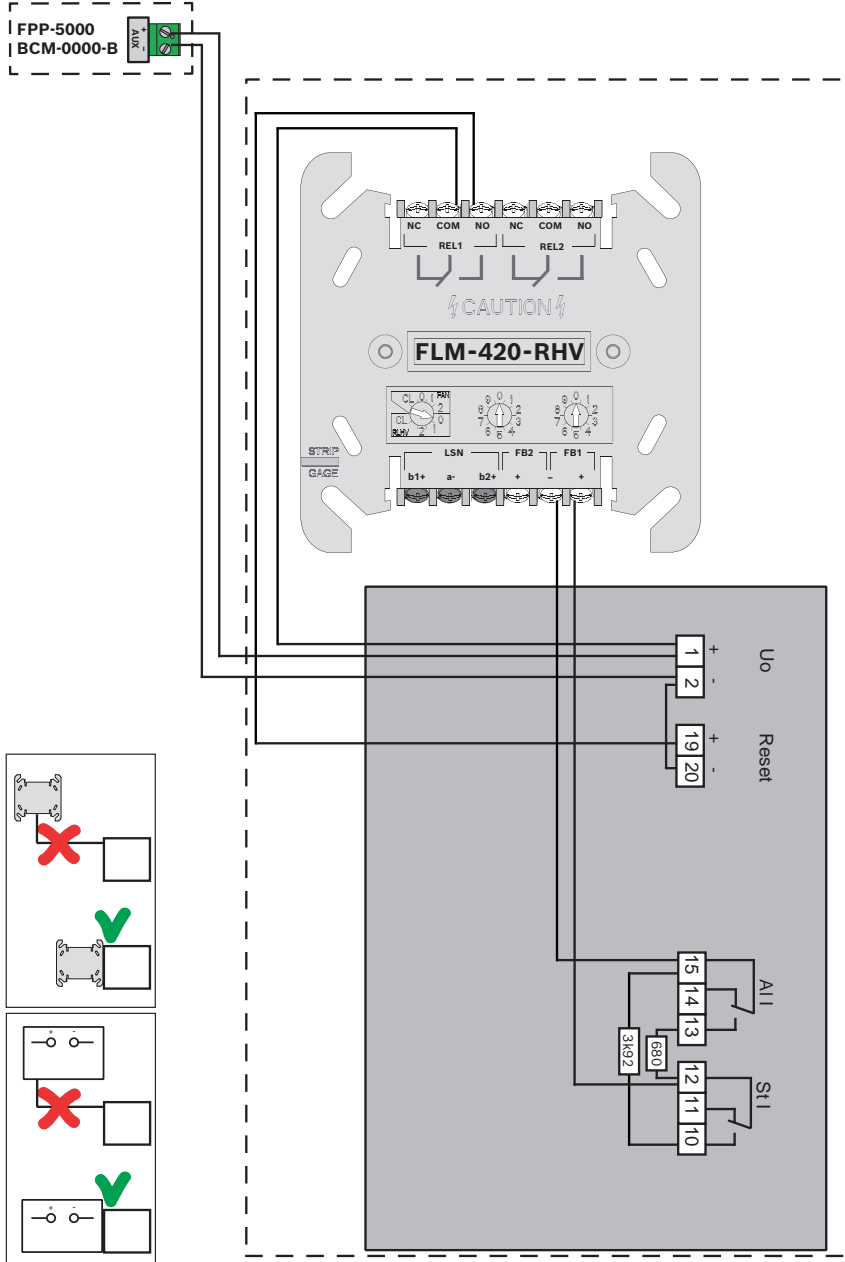

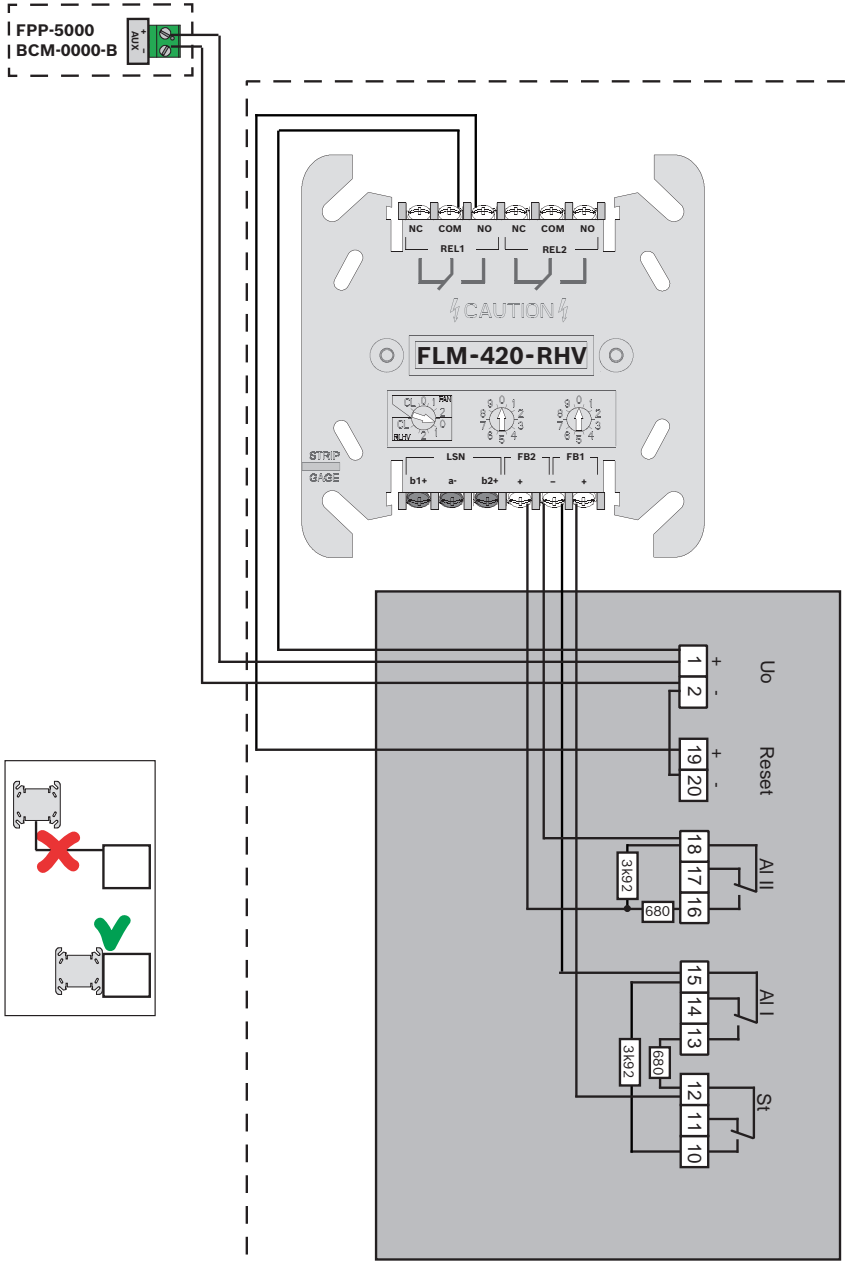
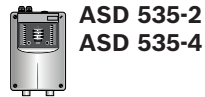



ELS

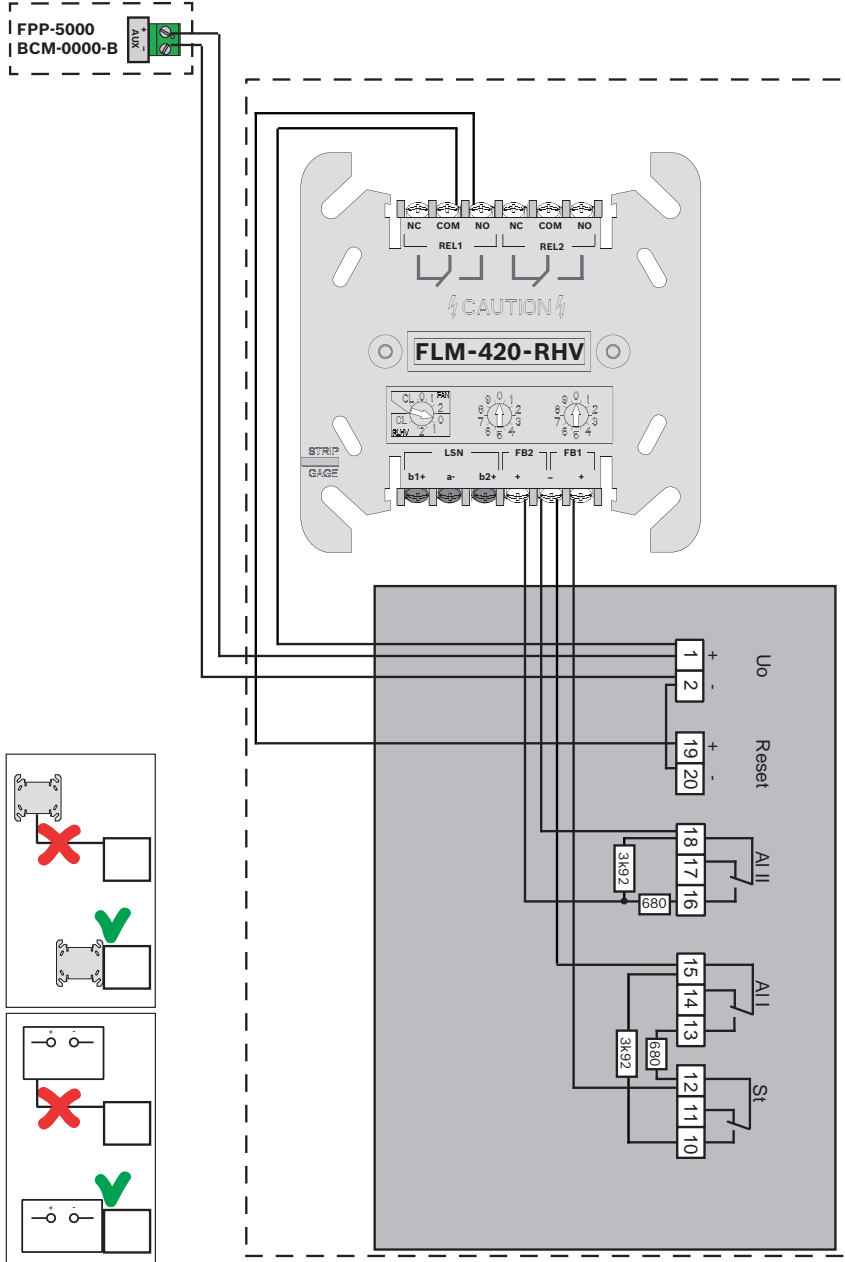

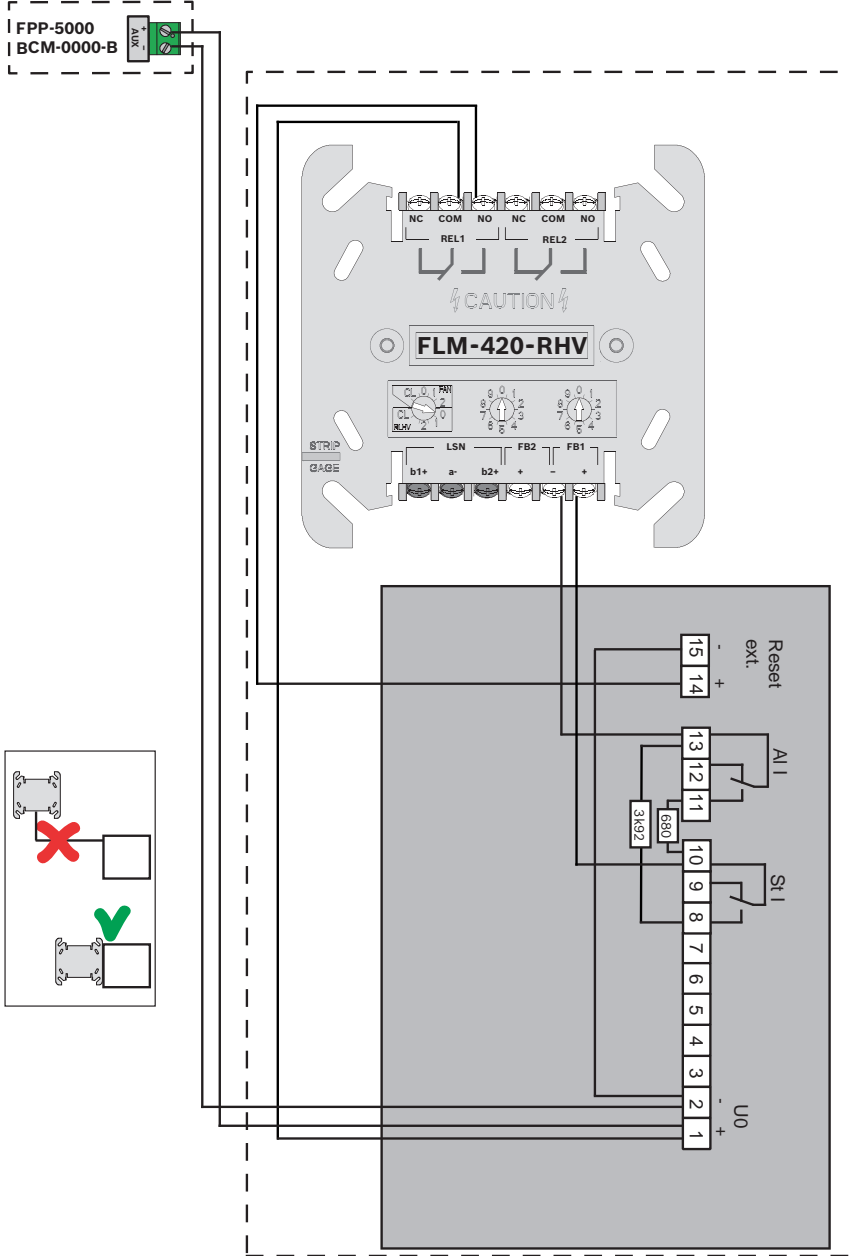



ELS

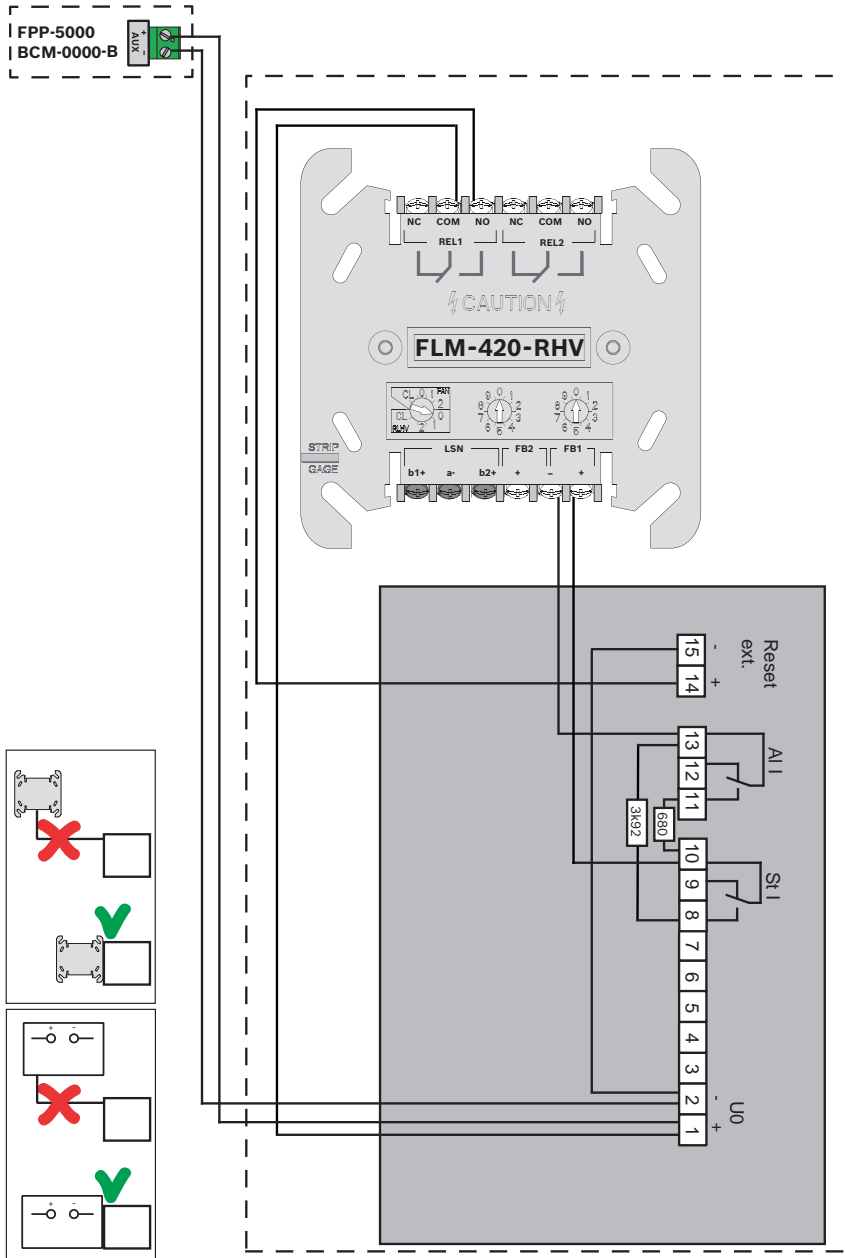



ADW 535-1

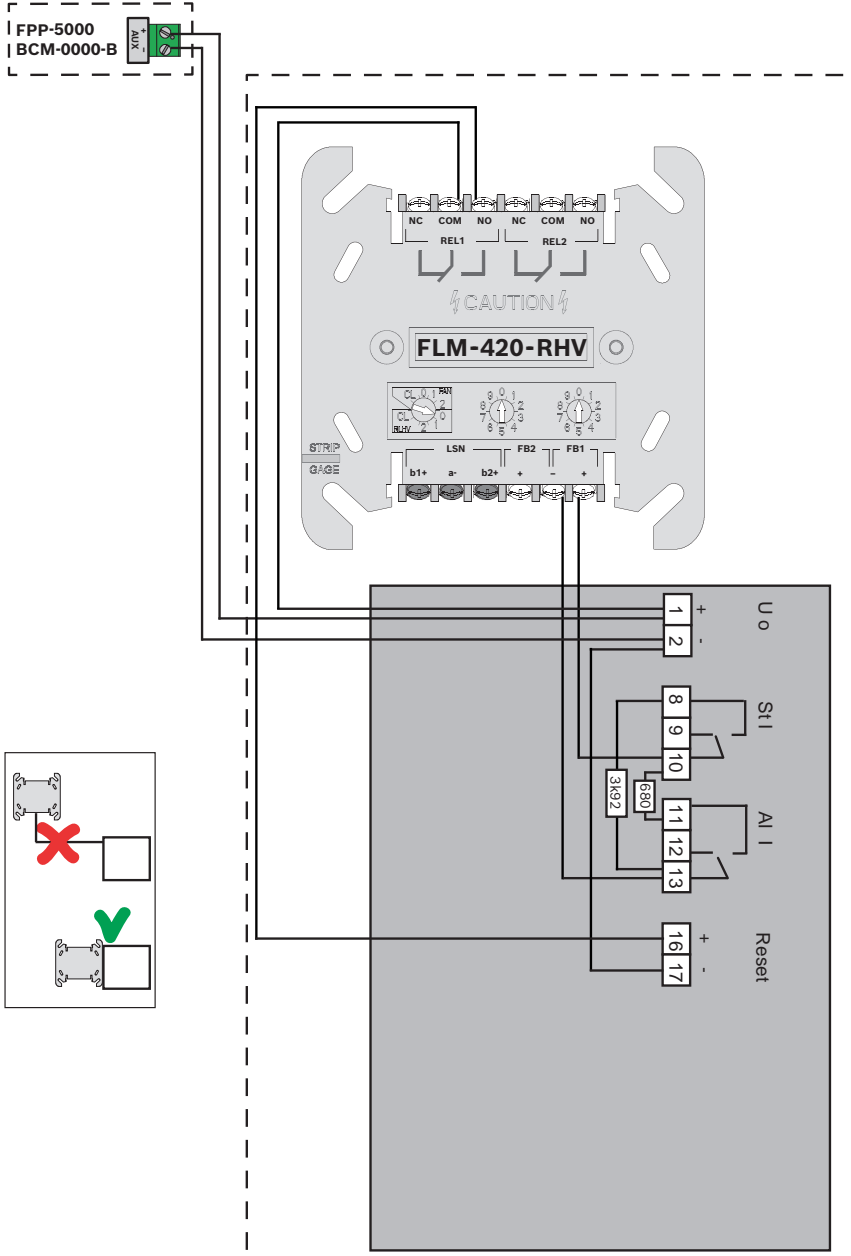



ADW 535-1



ELS

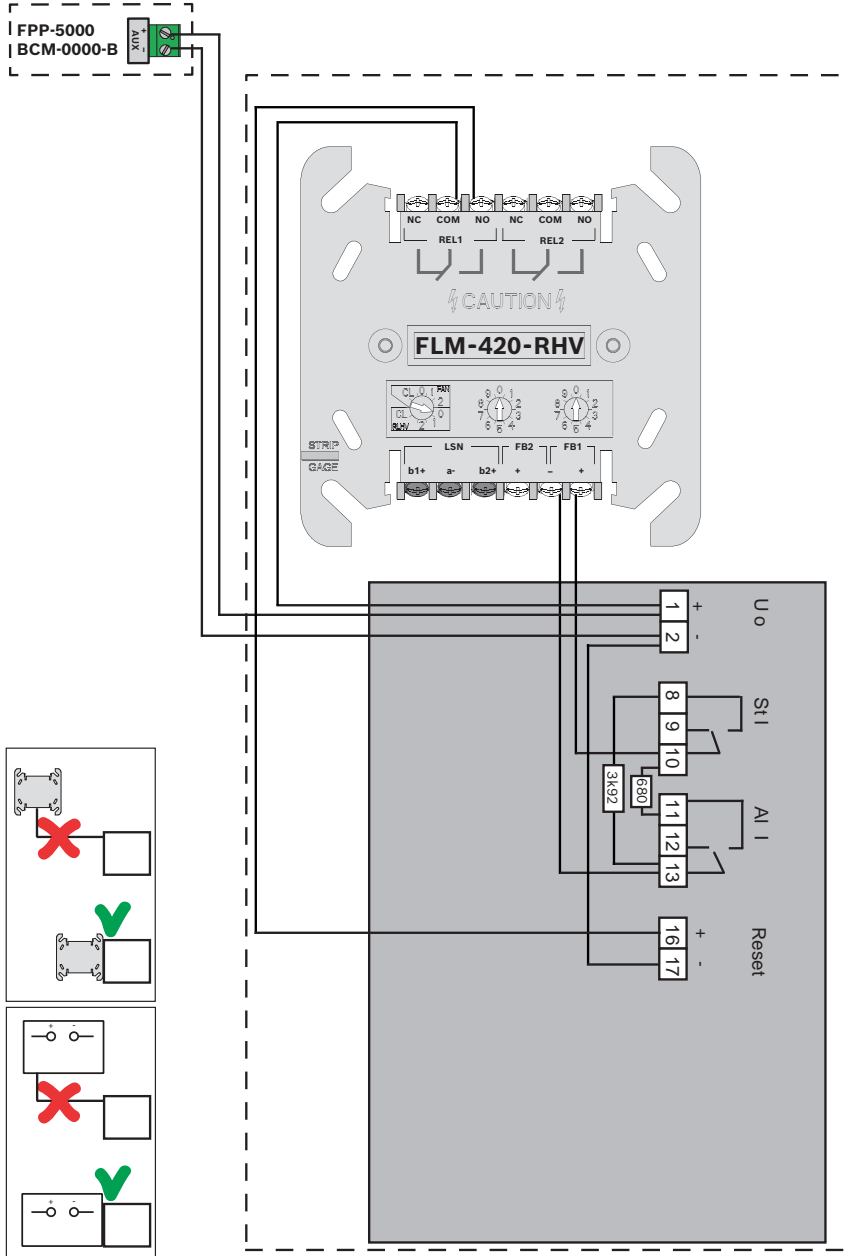



ADW 535-2

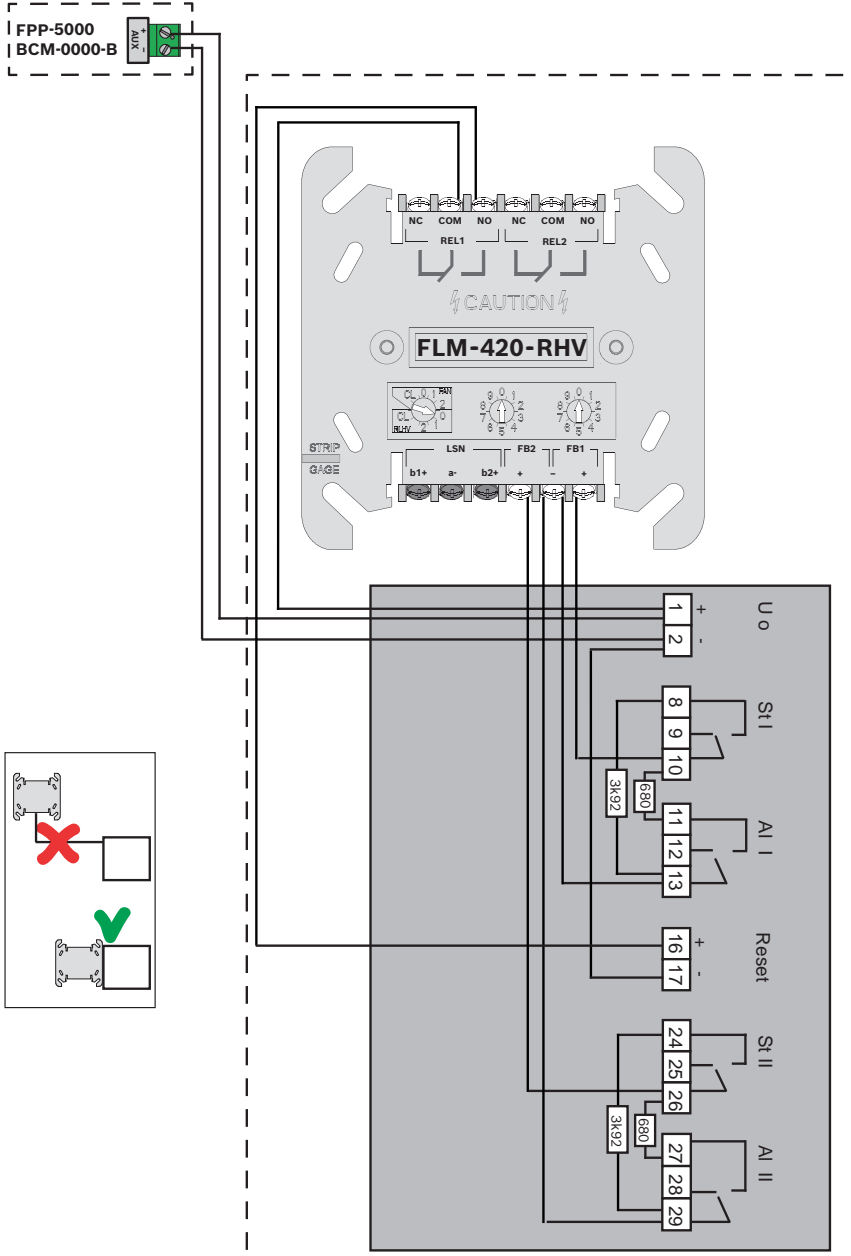



ADW 535-2



ELS

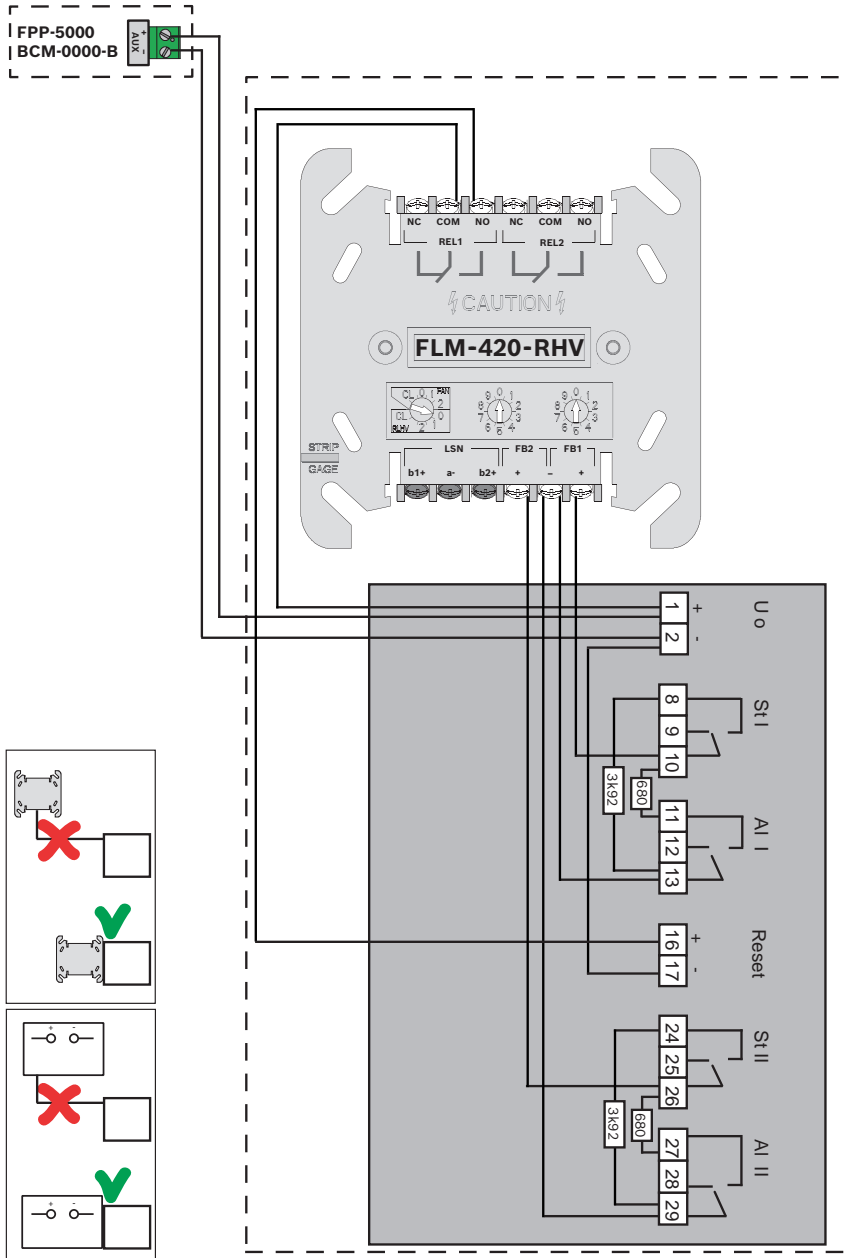



Fireray One

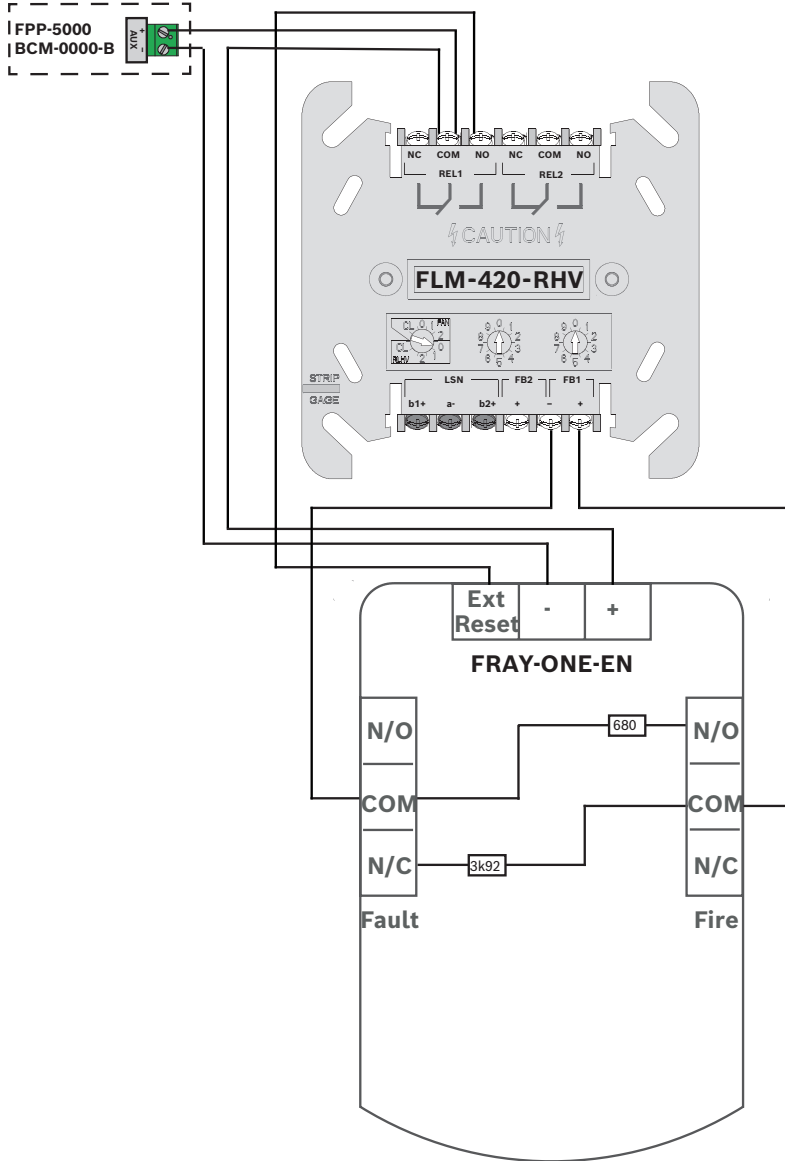



Fireray One



ELS

FPP-5000
BCM-0000-B

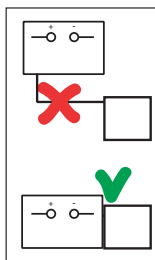
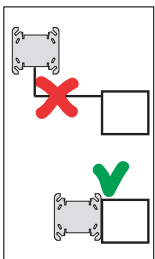
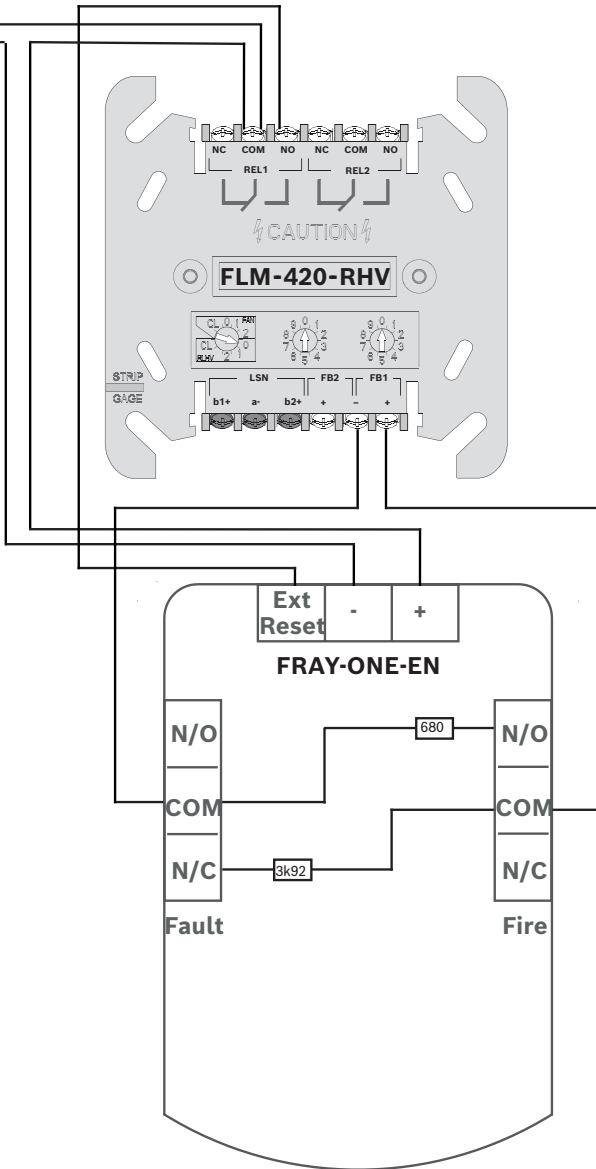

2.5.5

FLM-420-RLE-S



VdS 2496

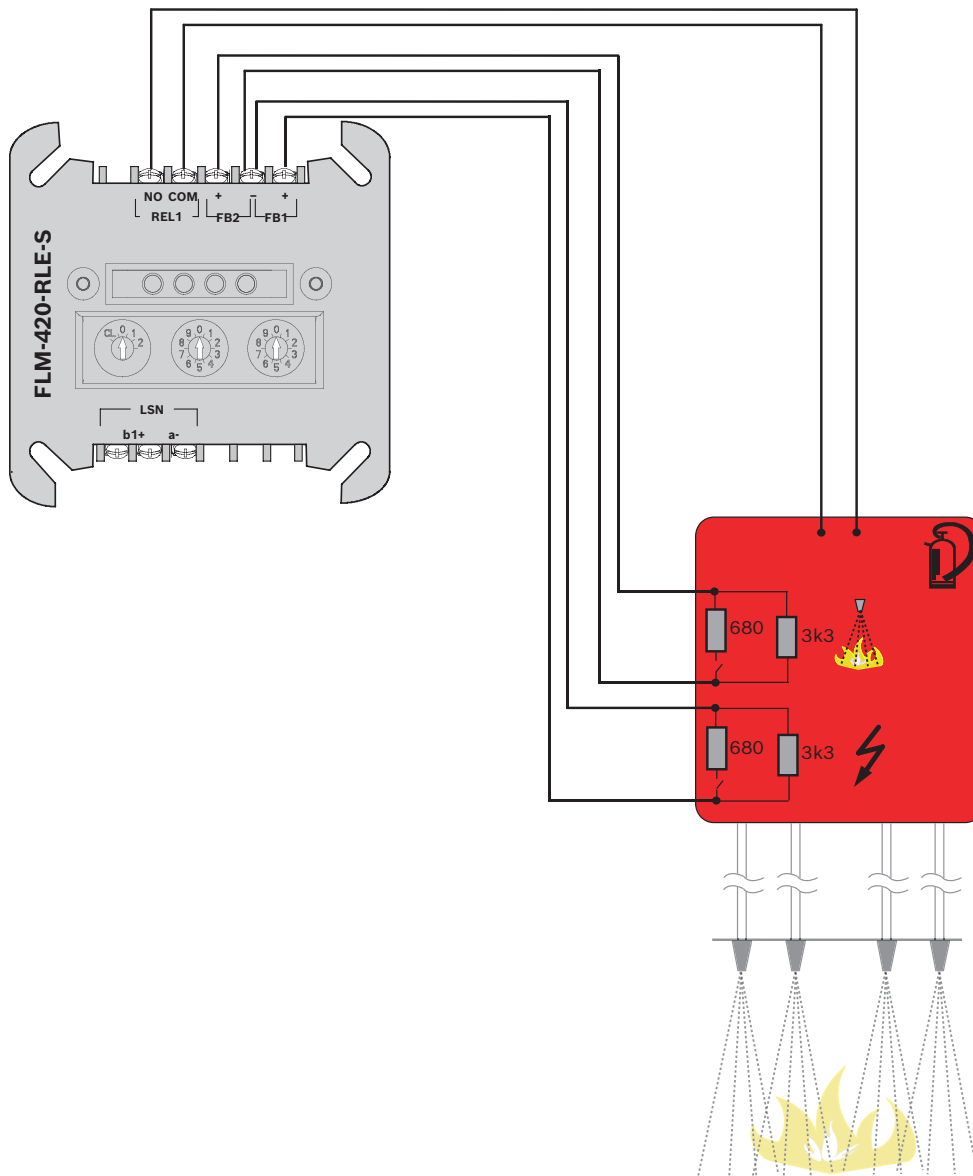

2.5.6 FLM-420-RLV1-E

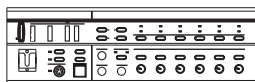
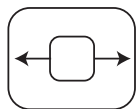

Plena

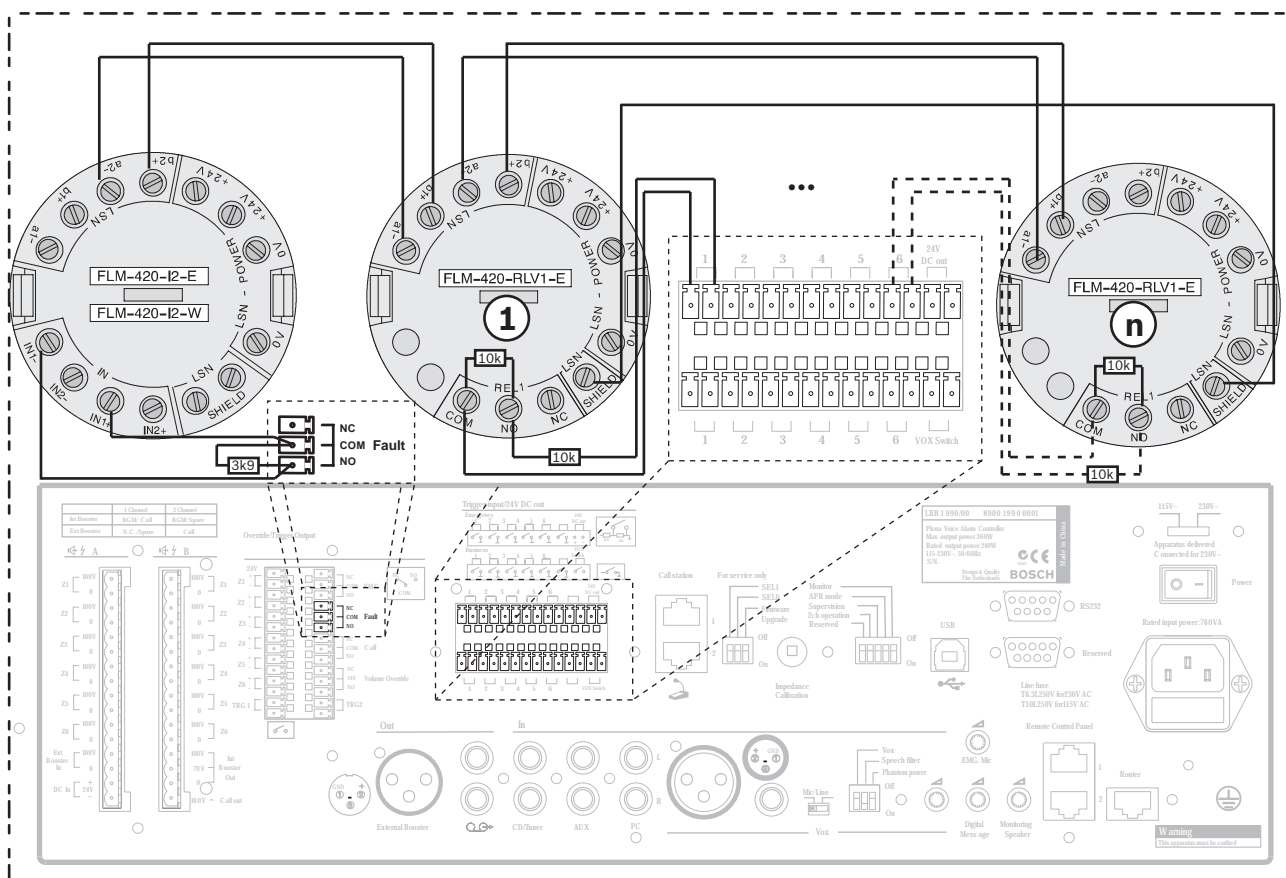

2.5.7 FLM-420-RLV8-S

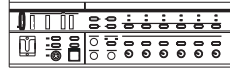
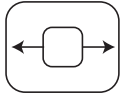

Plena

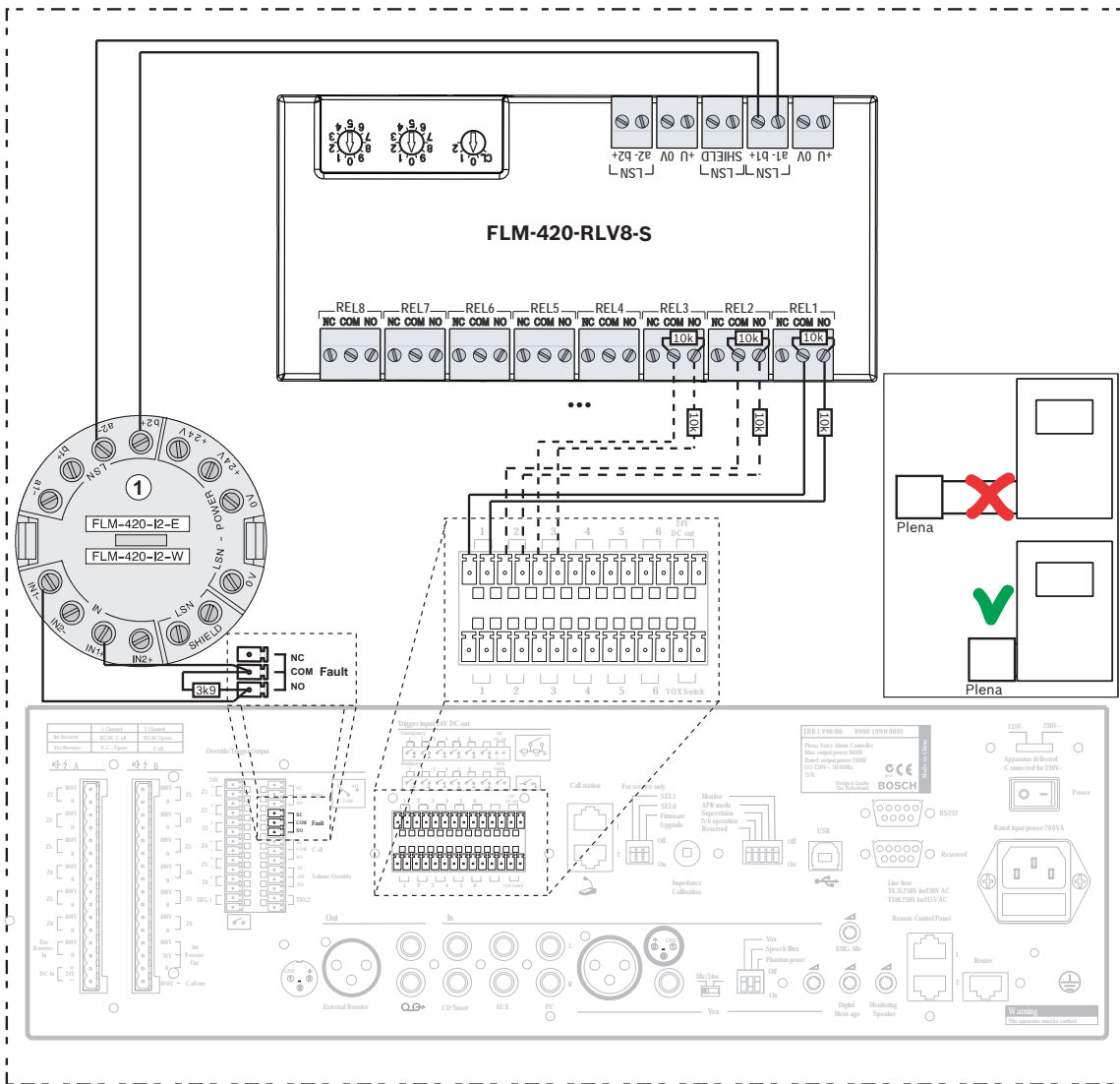
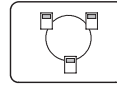

2.5.8 FMF-ADP-FBF/FMF-ADP-TTY



FAT4000 FBF4000 ADP4000

FMF-FAT FMF-FBF-FAT
FMF-FIBS-A4/-A3
FMF-ADP

ELS

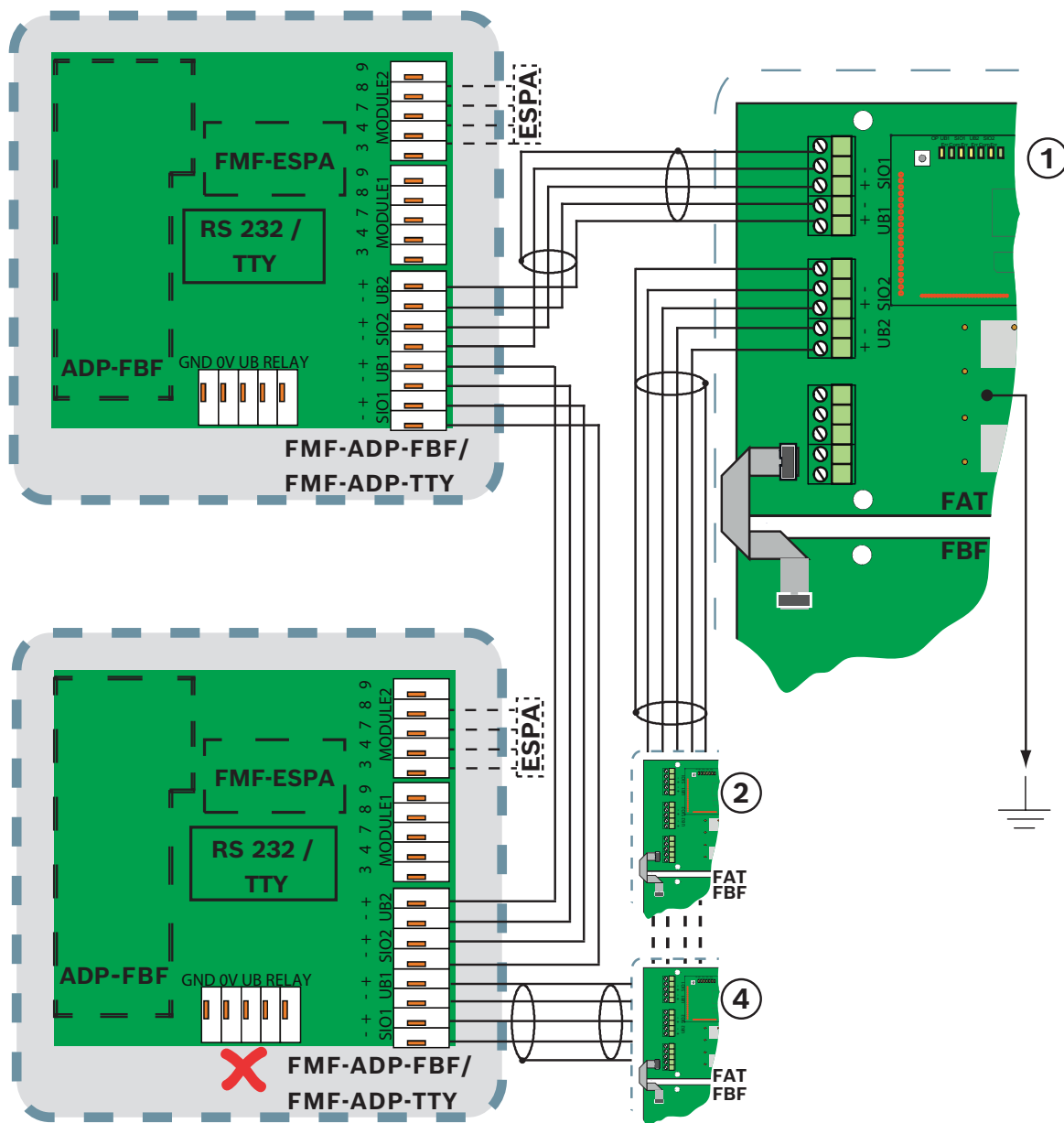

2.6

EOL



CZM 0004 A, stranica 189

LSN 0300 A, stranica 201

FLM-420/4-CON-S/D, stranica 246

2.6.1

CZM 0004 A

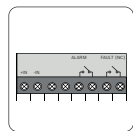
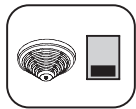

016519, 016589
IR3 Flame Detector

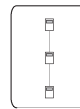

ELS

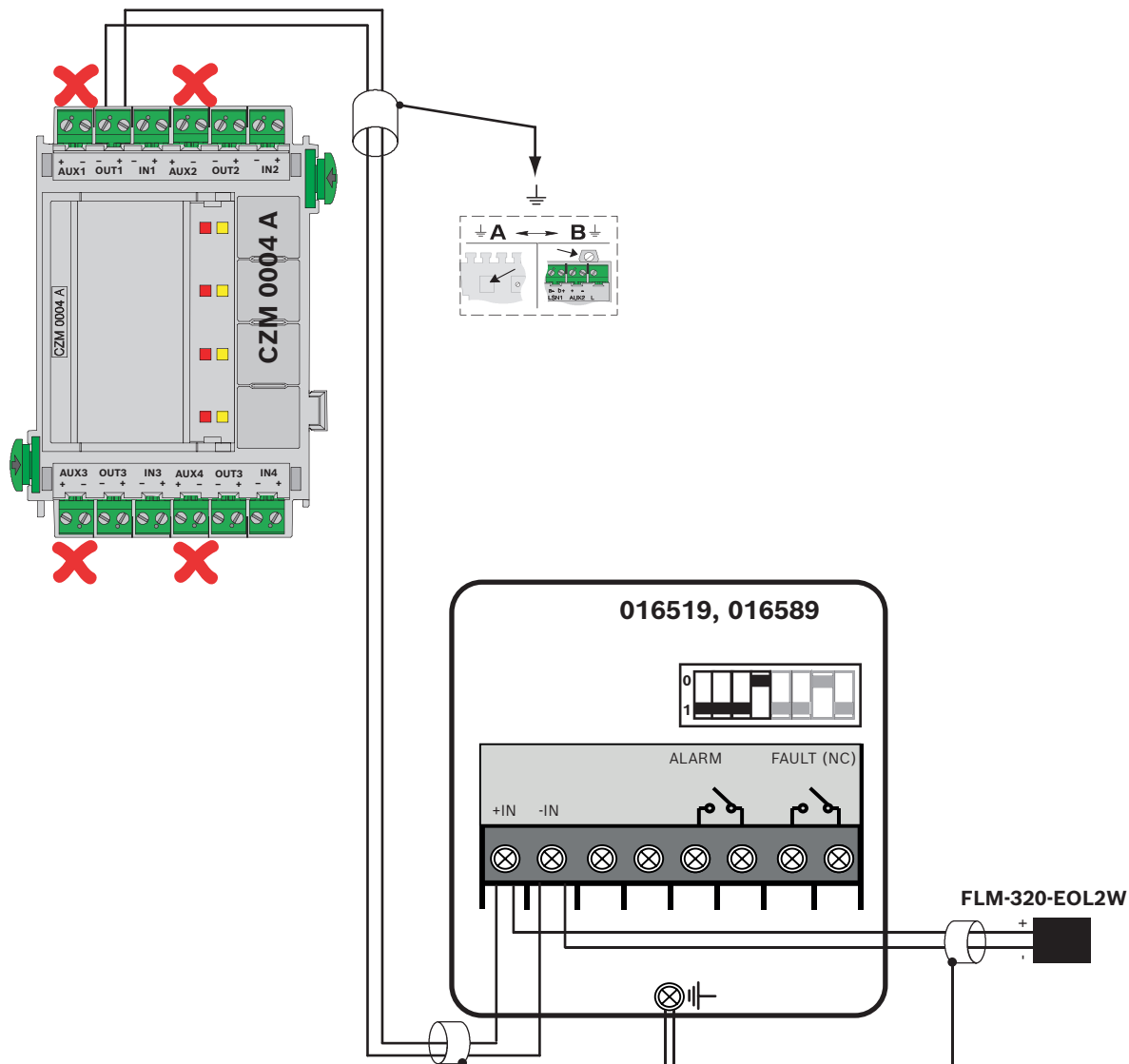

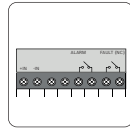

016519, 016589
IR3 Flame Detector

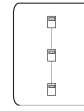

ELS

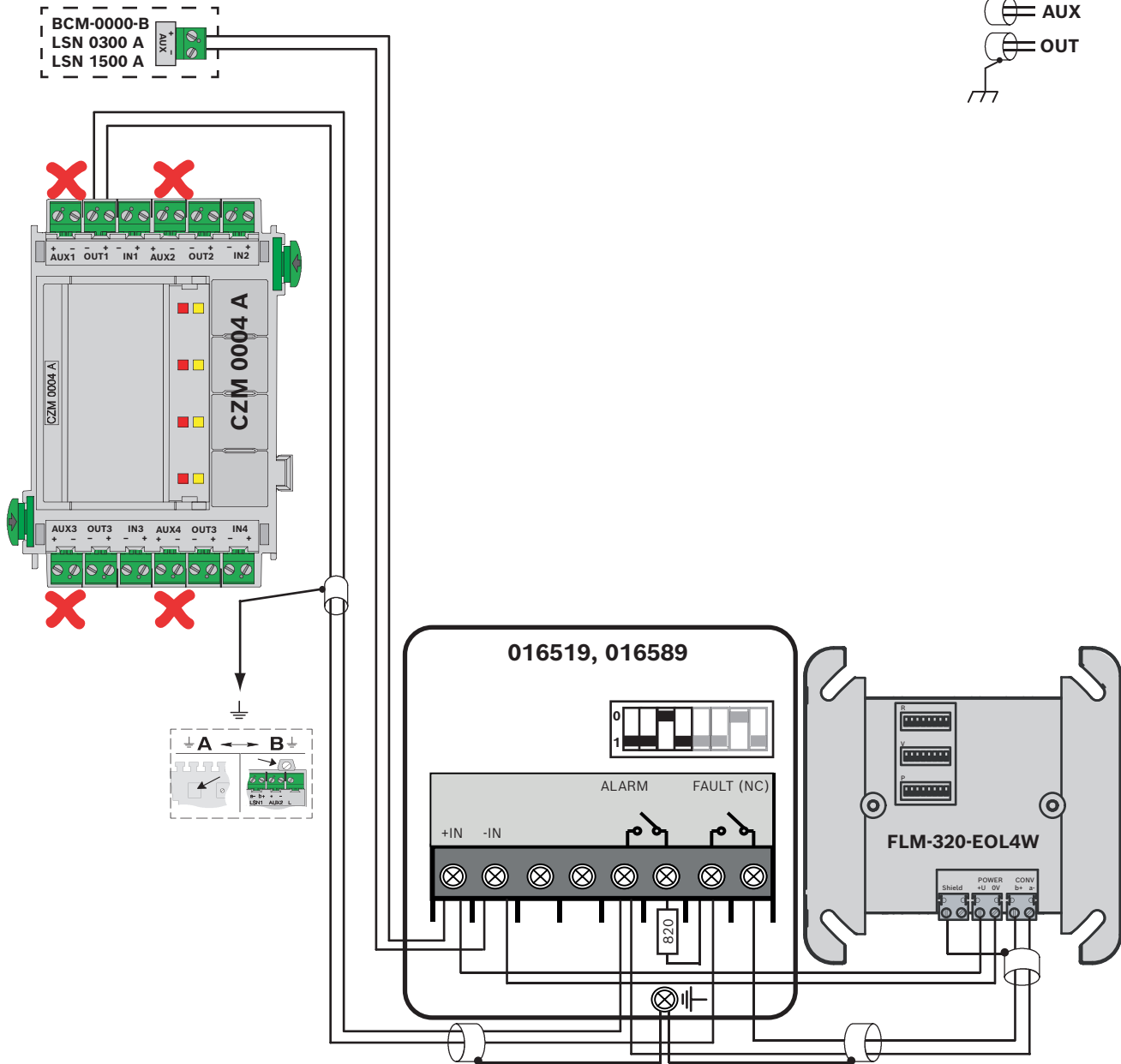



FCA-500-EU
FCP-O 500
FCP-O 500-P
FCP-OC 500
FCP-OC 500-P



ELS

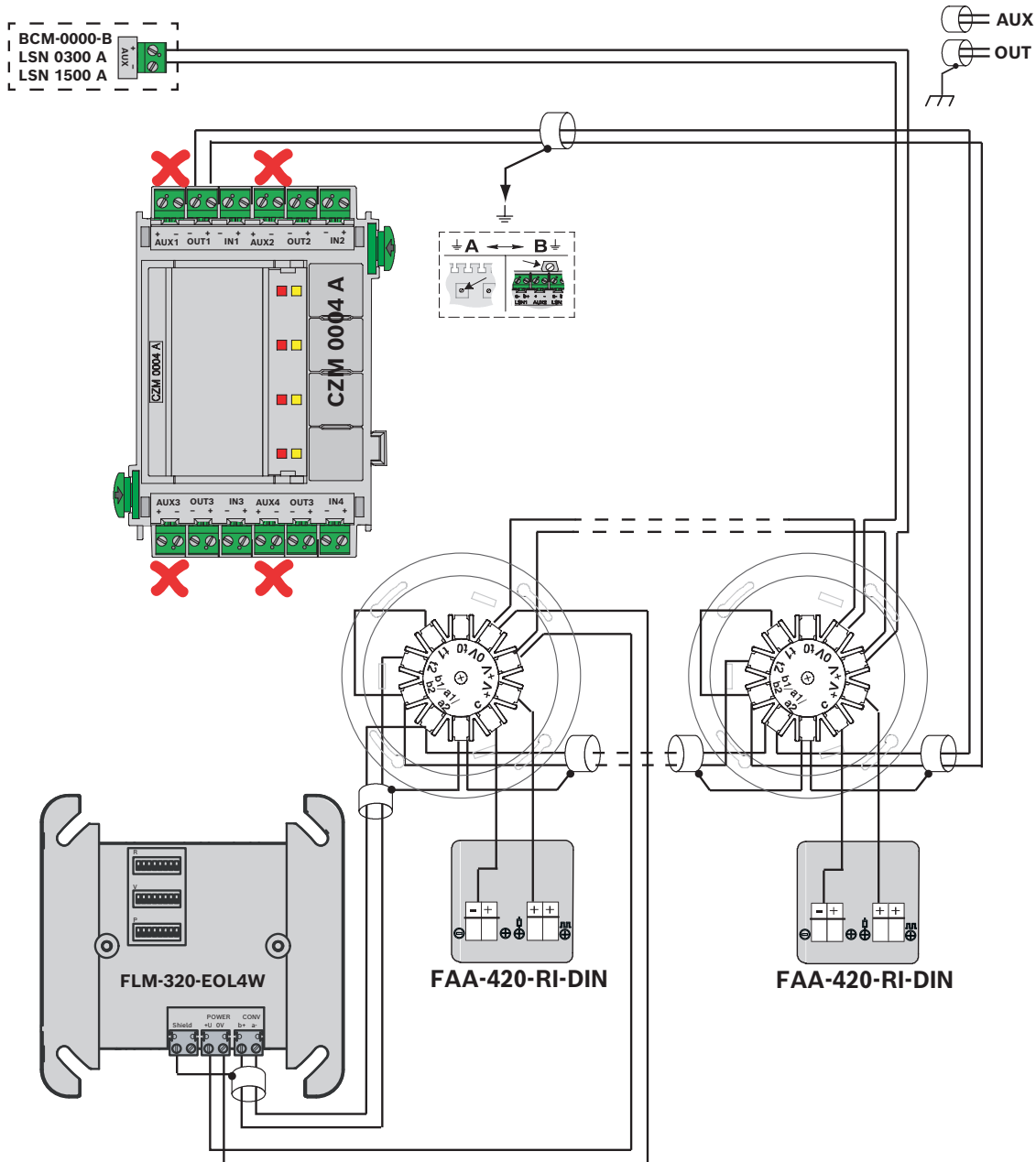

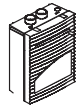

FCS-320-TM Series

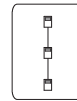

ELS

BCM-0000-B
LSN 0300 A
LSN 1500 A

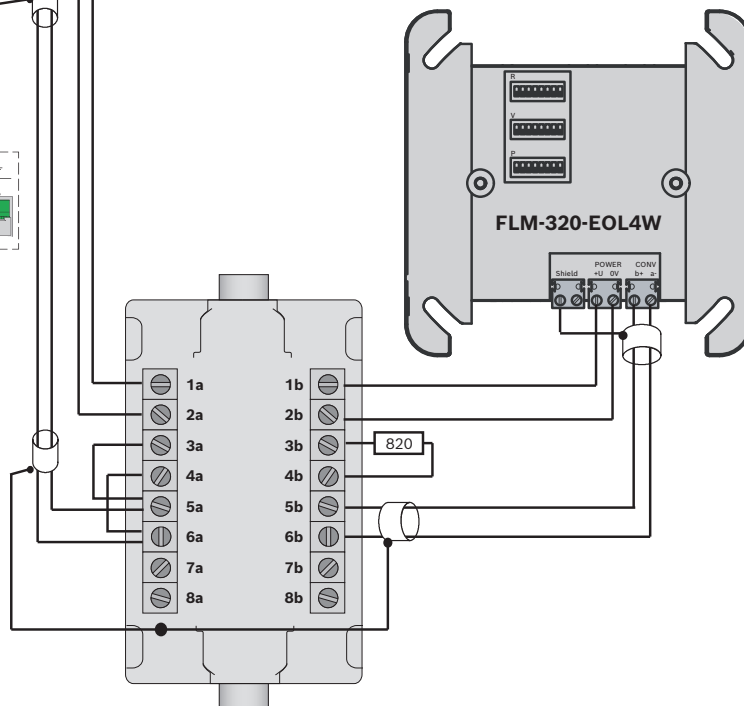
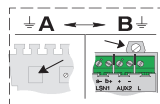
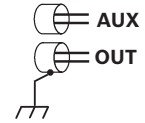
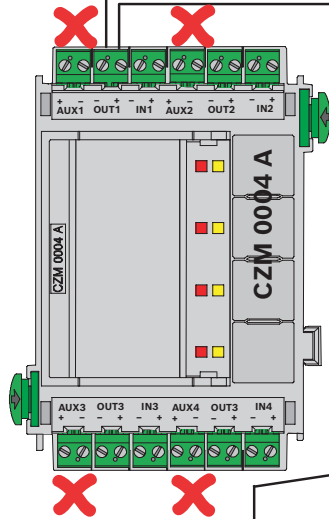

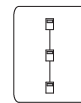
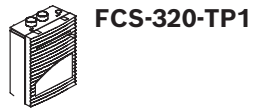

ELS

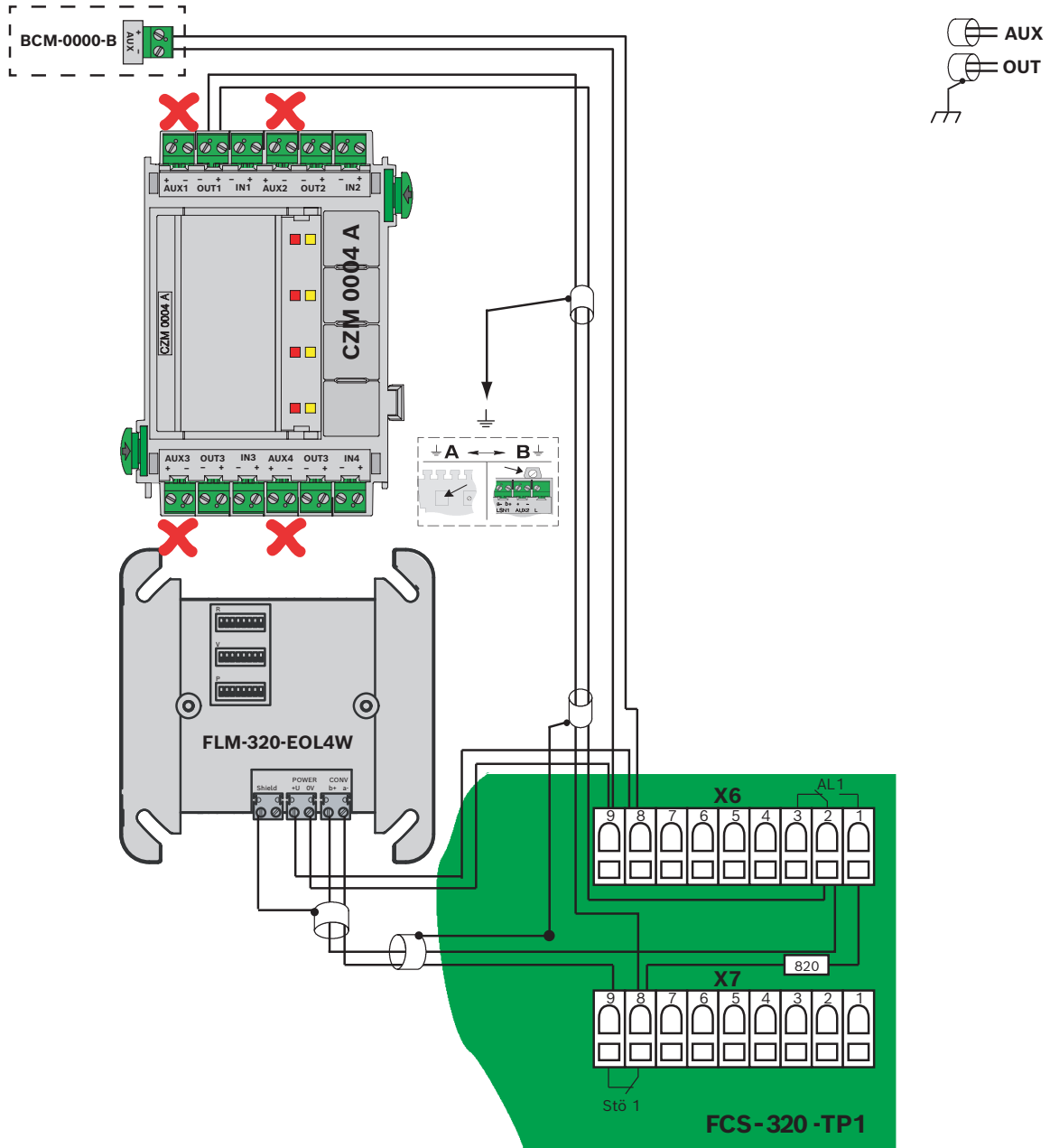

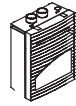

FCS-320-TP2



ELS

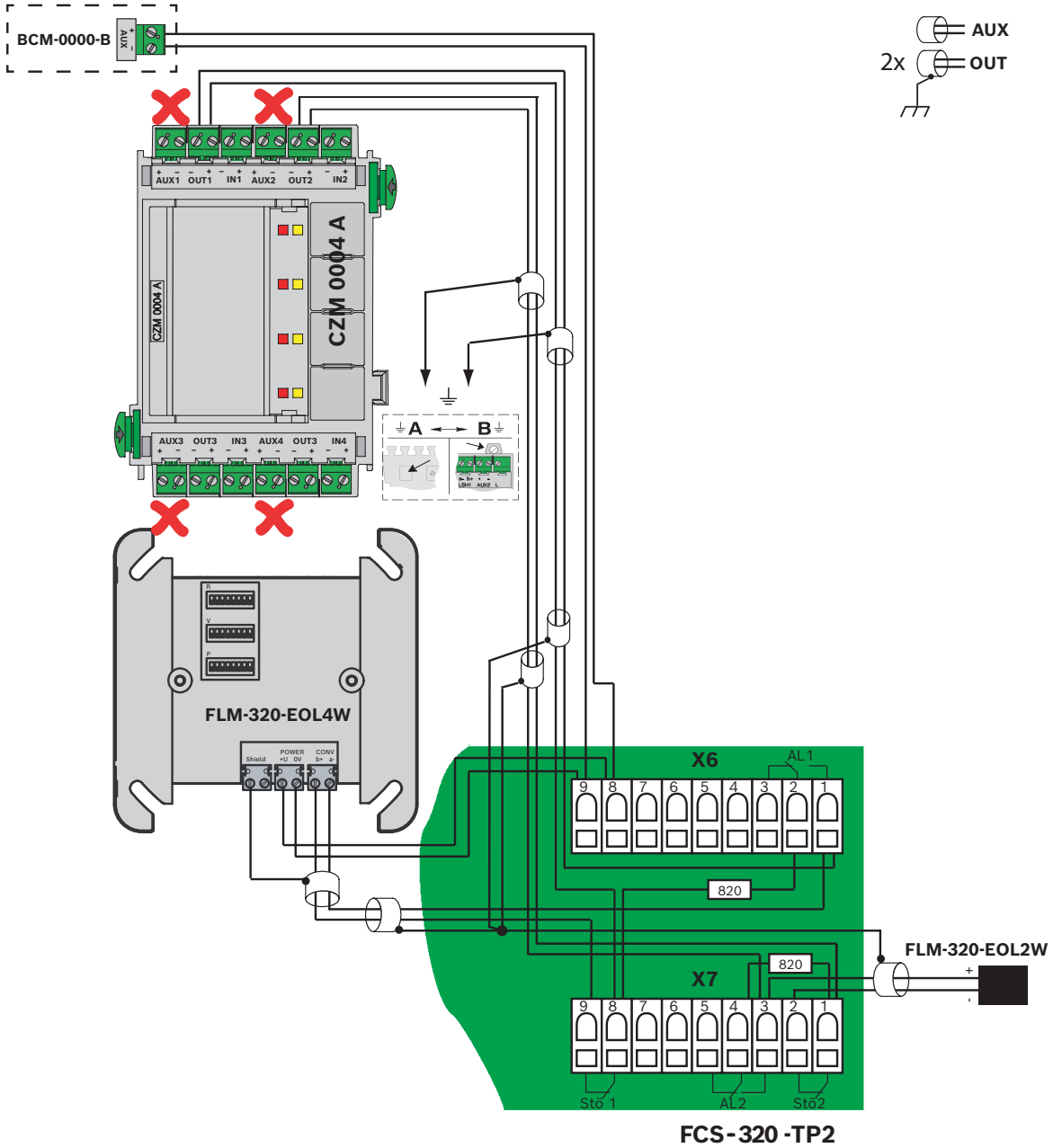



FIRERAY3000

1 x



ELS

BCM-0000-B
LSN 0300 A
LSN 1500 A

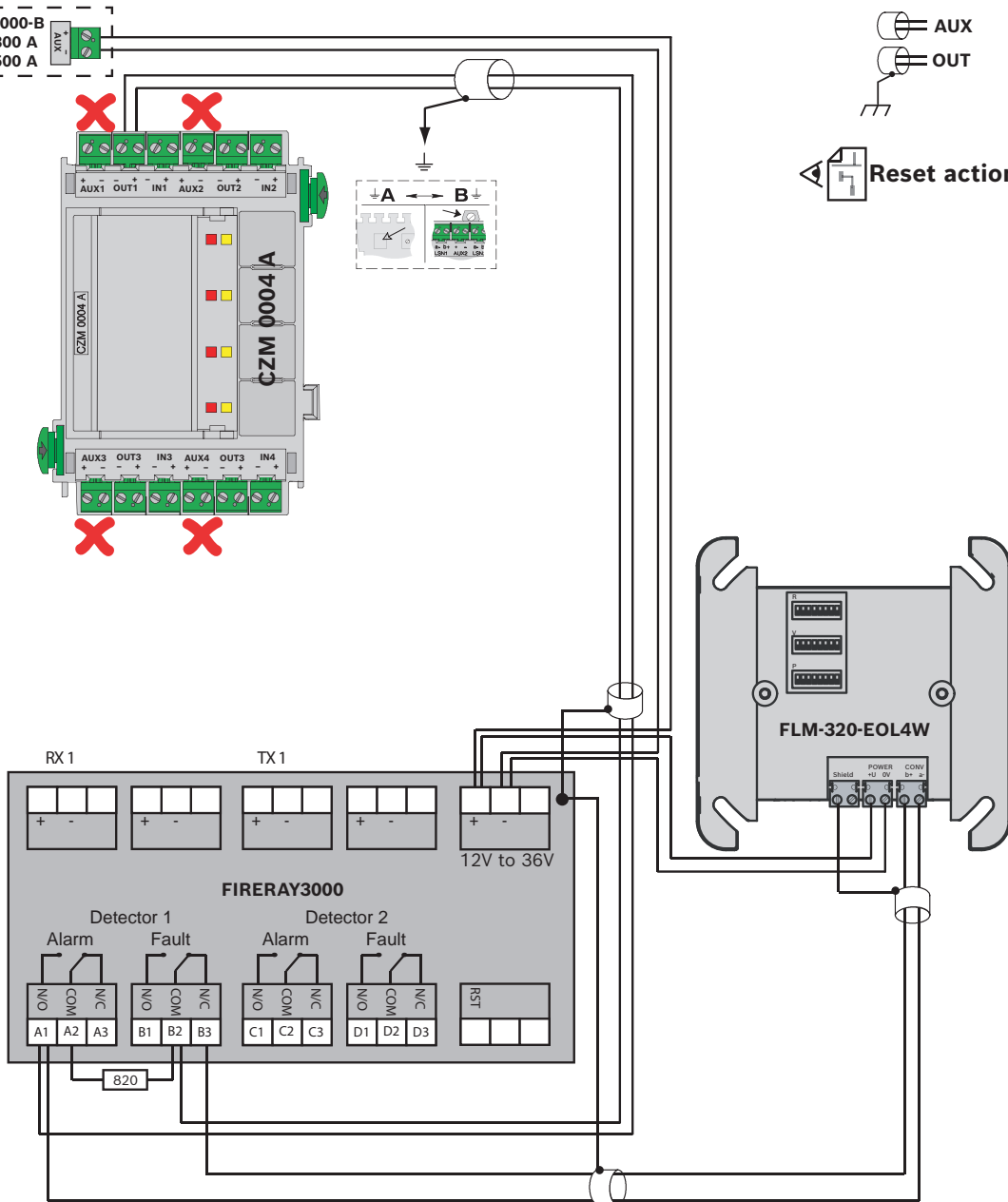

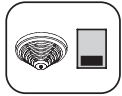

FIRERAY3000
2 x  **OUT1**



ELS

BCM-0000-B
LSN 0300 A
LSN 1500 A

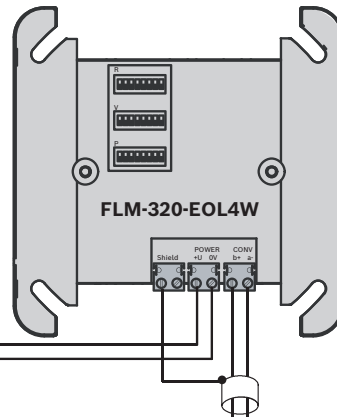
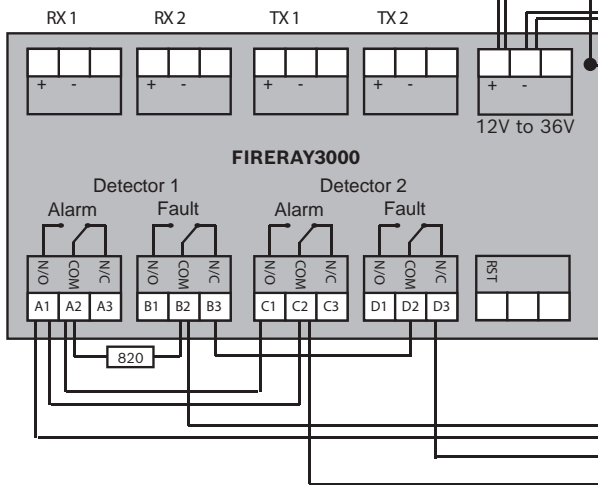
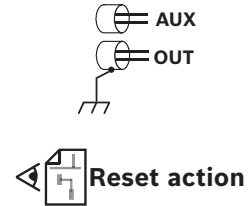
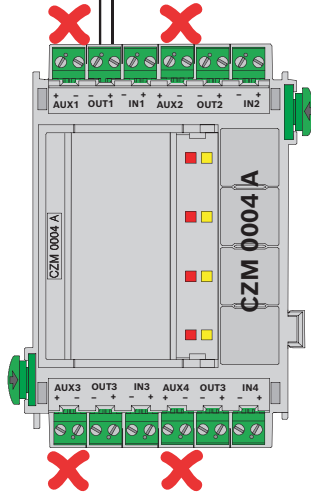



FIRERAY3000
2 x **OUT1+2**



ELS

BCM-0000-B
LSN 0300 A
LSN 1500 A

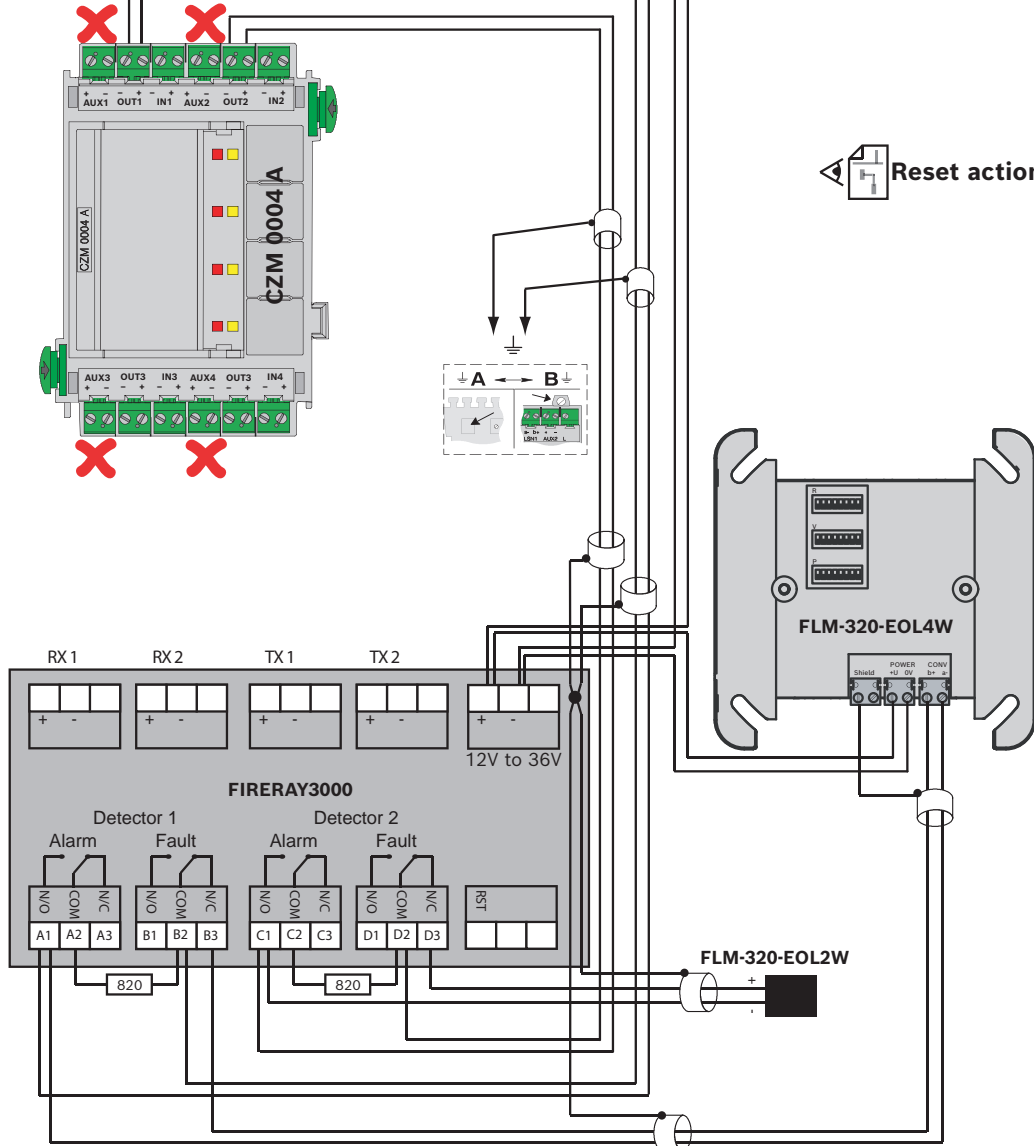



FIRERAY5000

1 x



ELS

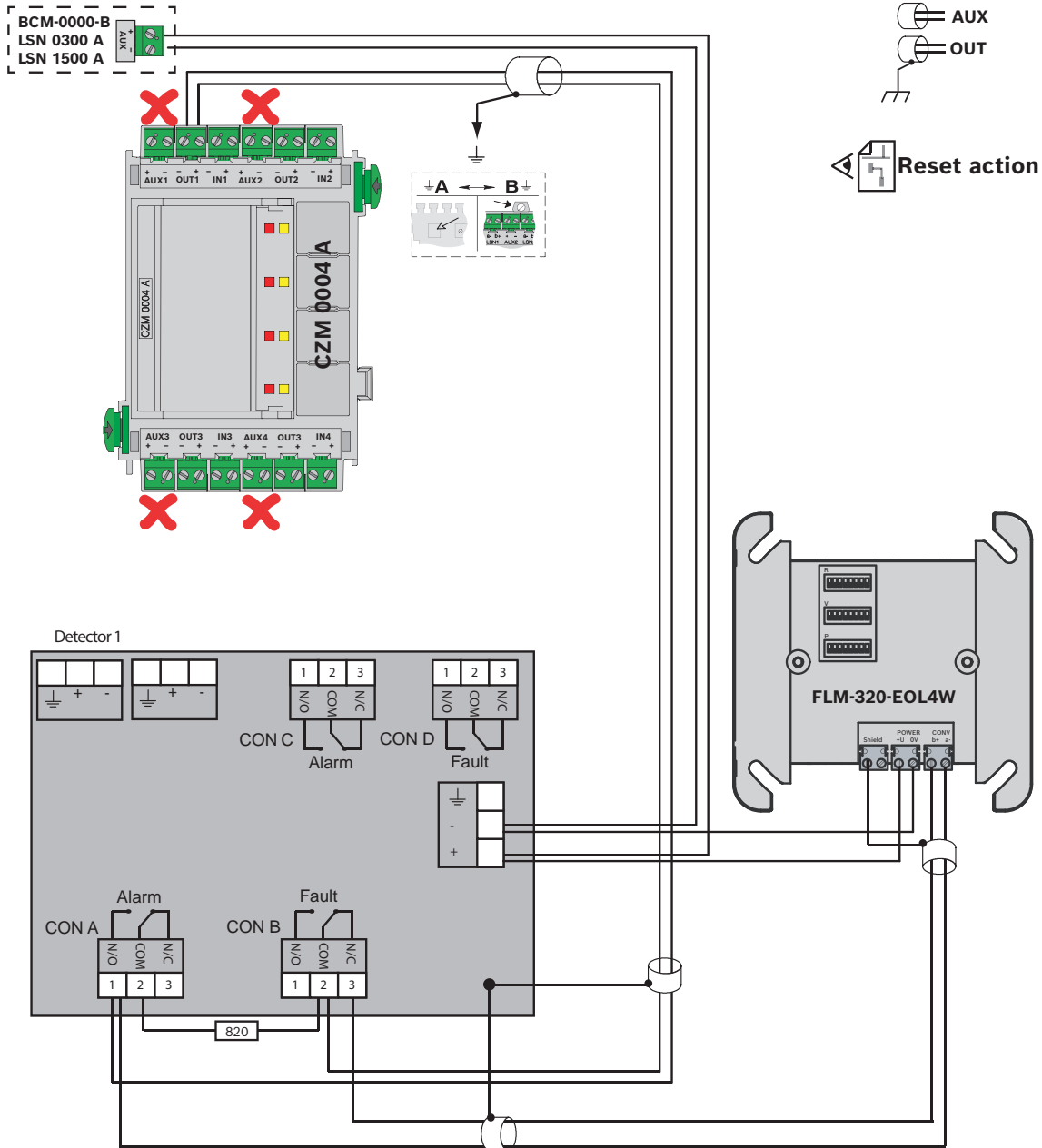

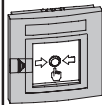
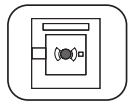

FMC-120-DKM-G-R
 FMC-120-DKM-H-R
 FMC-120-DKM-G-B
 FMC-120-DKM-H-B
 FMC-120-DKM-G-Y

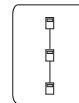

ELS

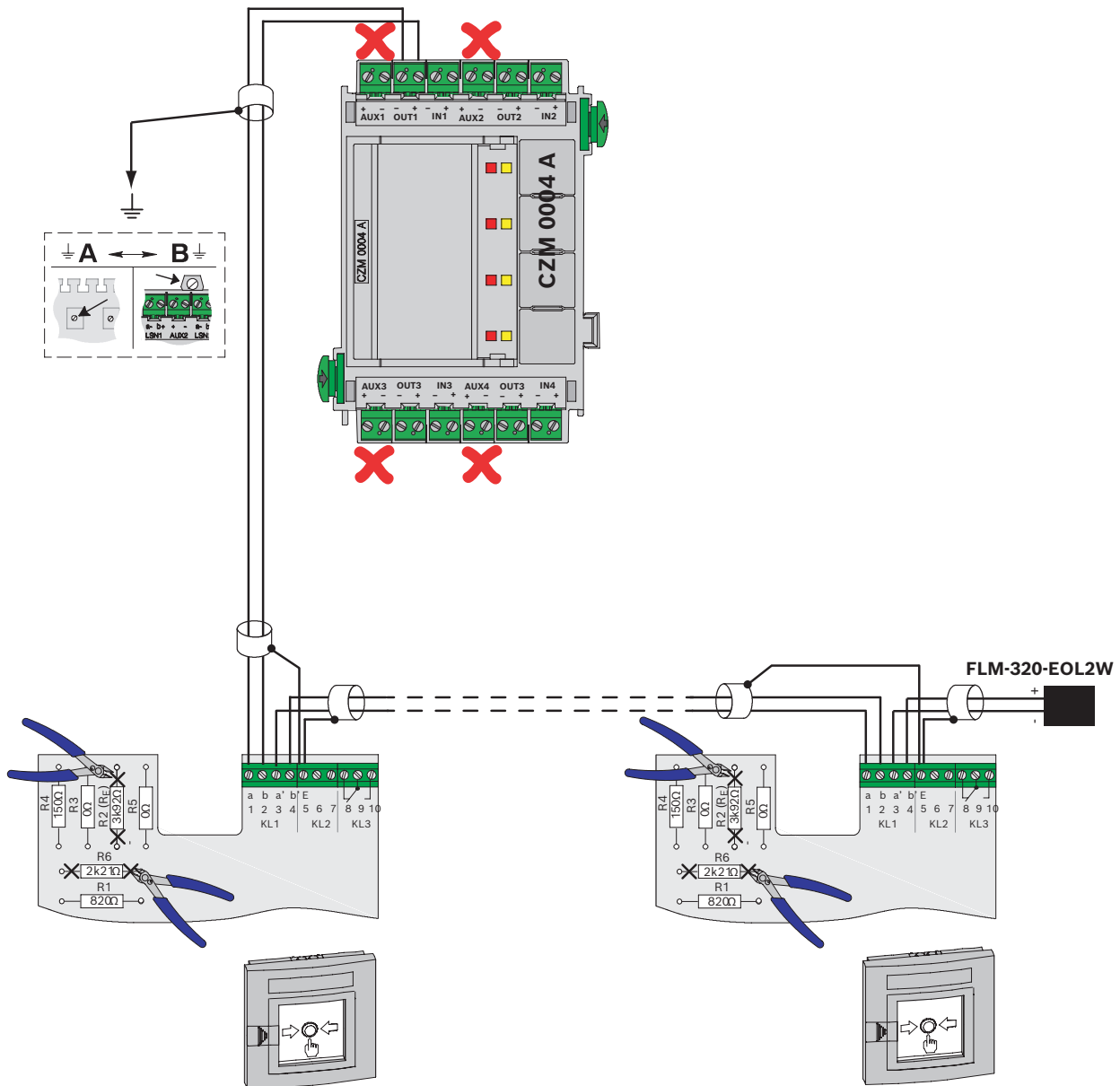

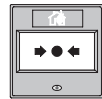
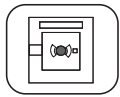

FMC-300RW-GSGBU
 FMC-300RW-GSRBU
 FMC-300RW-GSGRD
 FMC-300RW-GSRRD
 FMC-300RW-GSGYE
 FMC-300RW-GSRYE



ELS

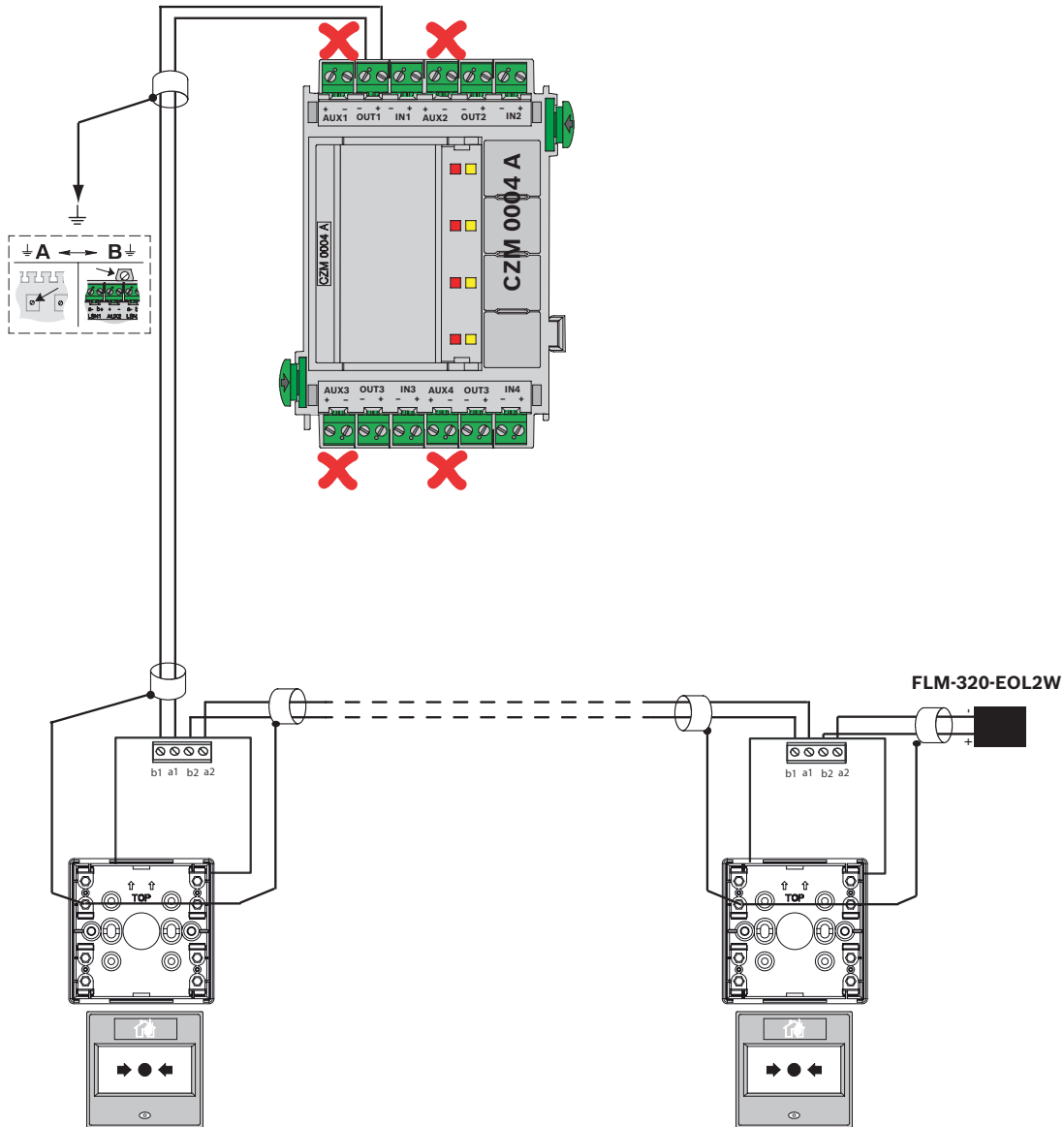

2.6.2 LSN 0300 A

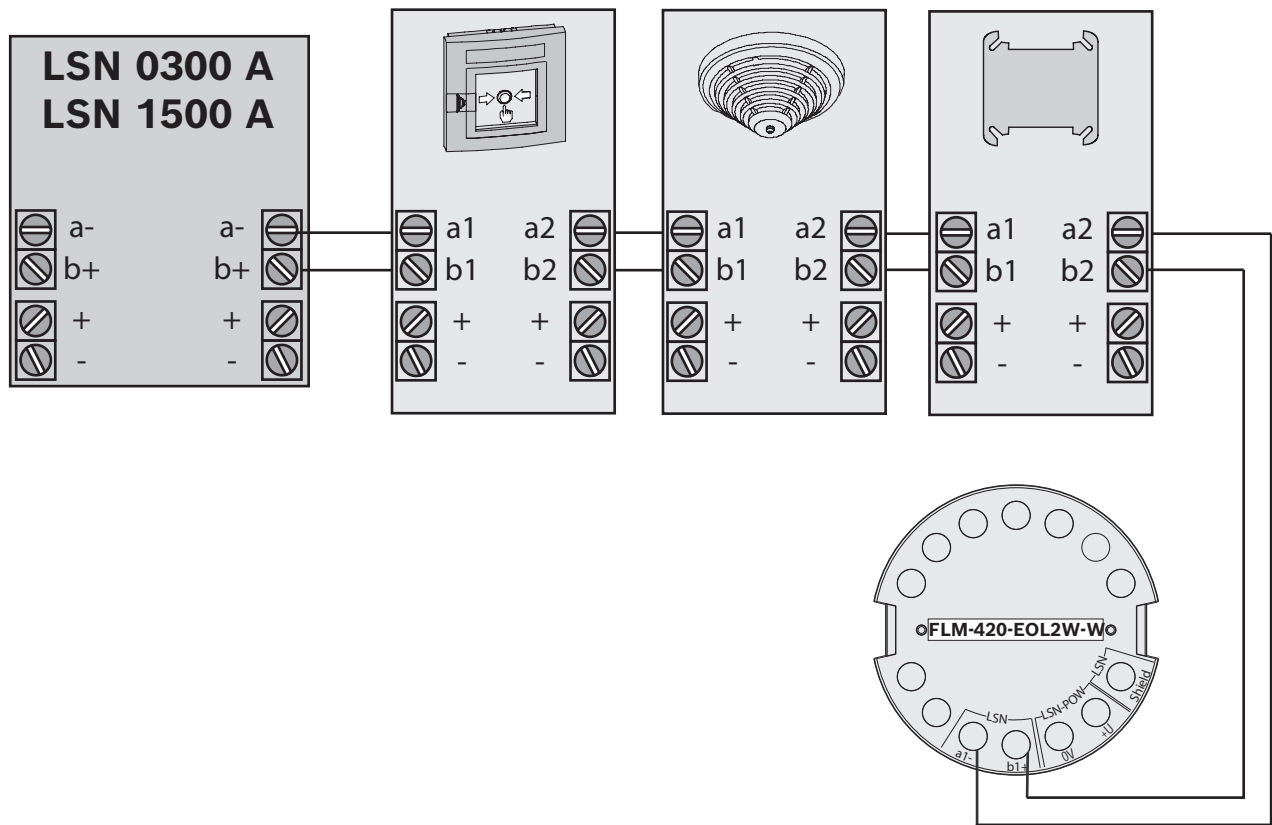
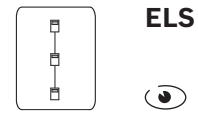

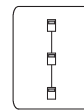

ELS

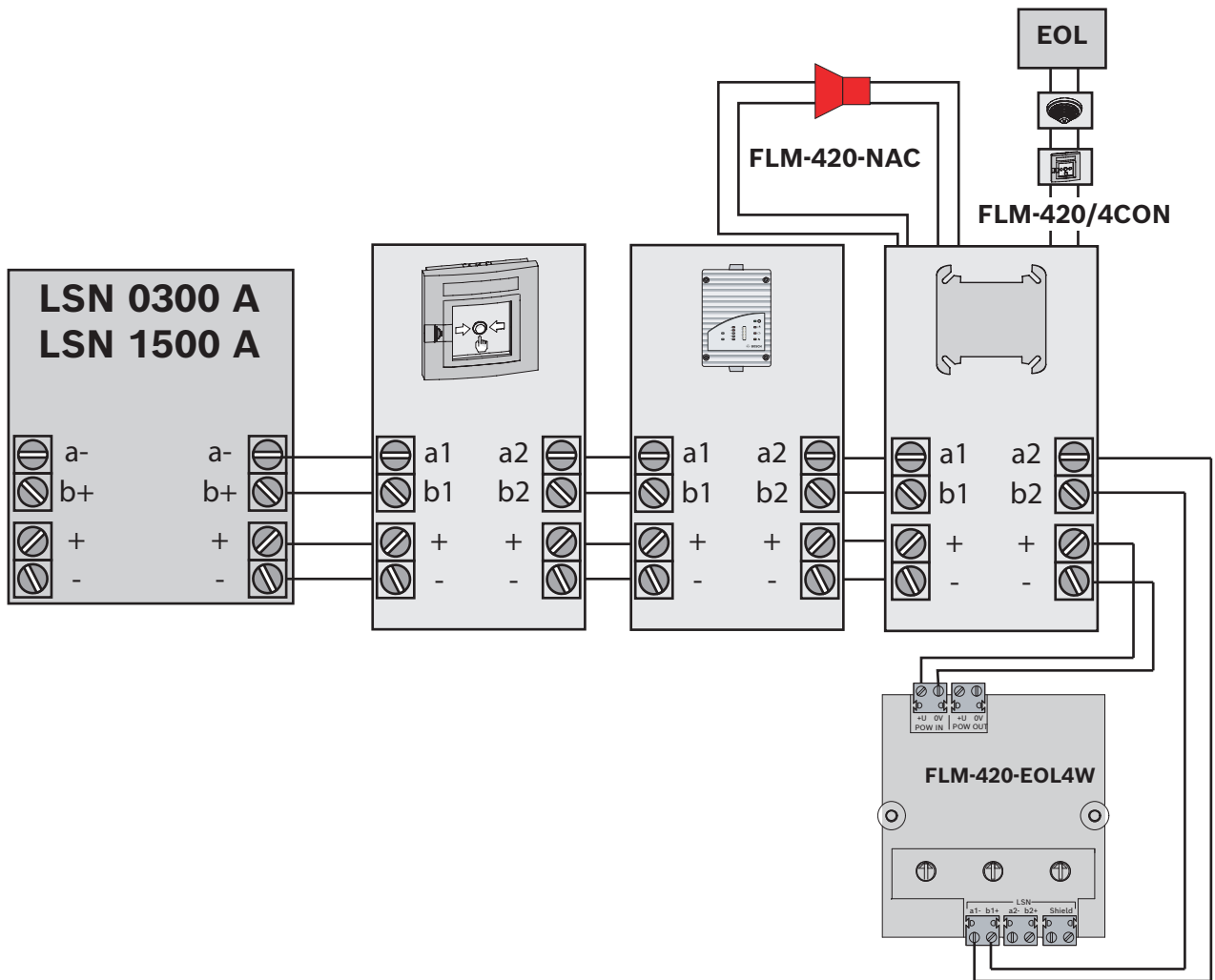

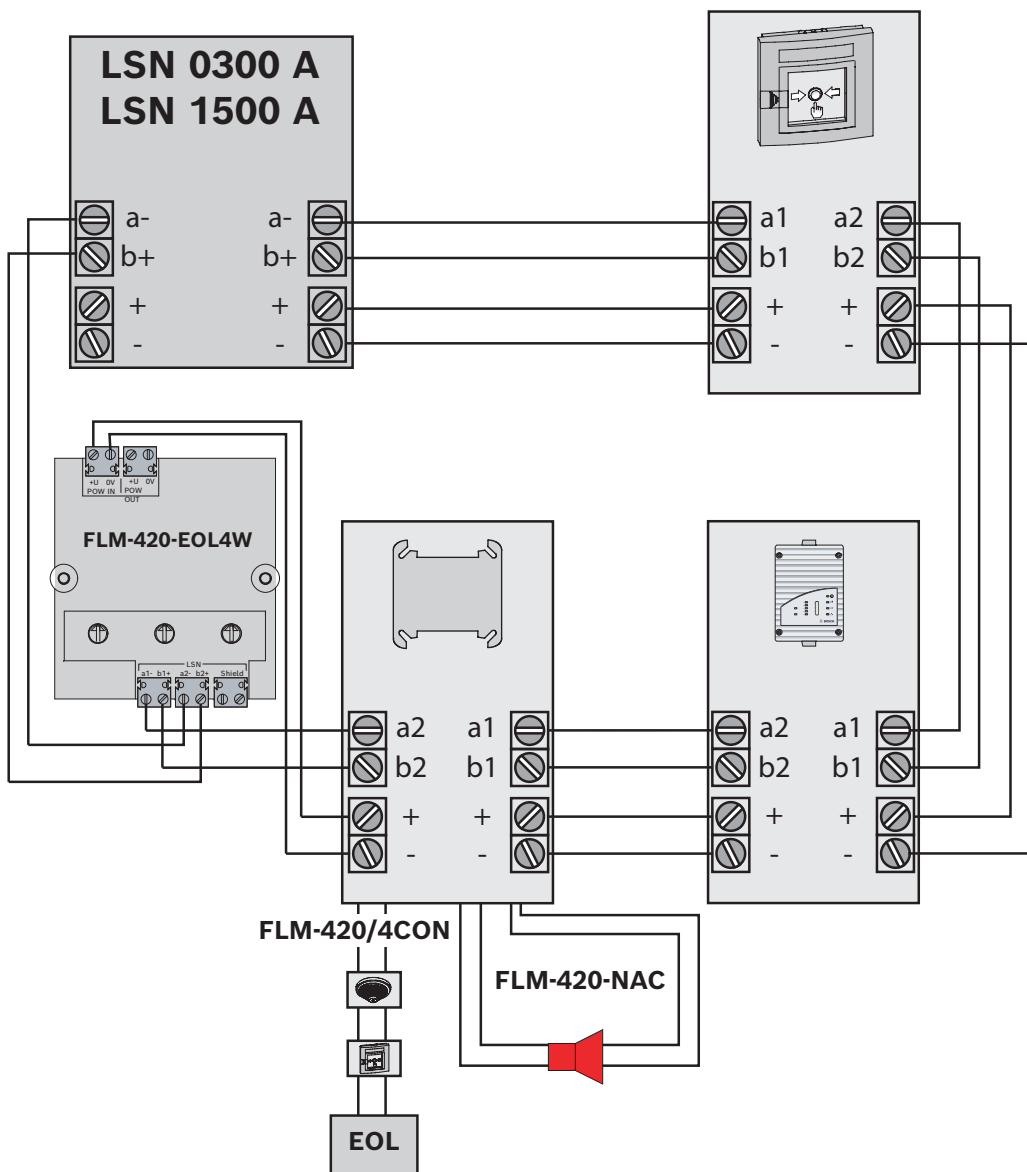
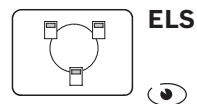

Reset action

ELS

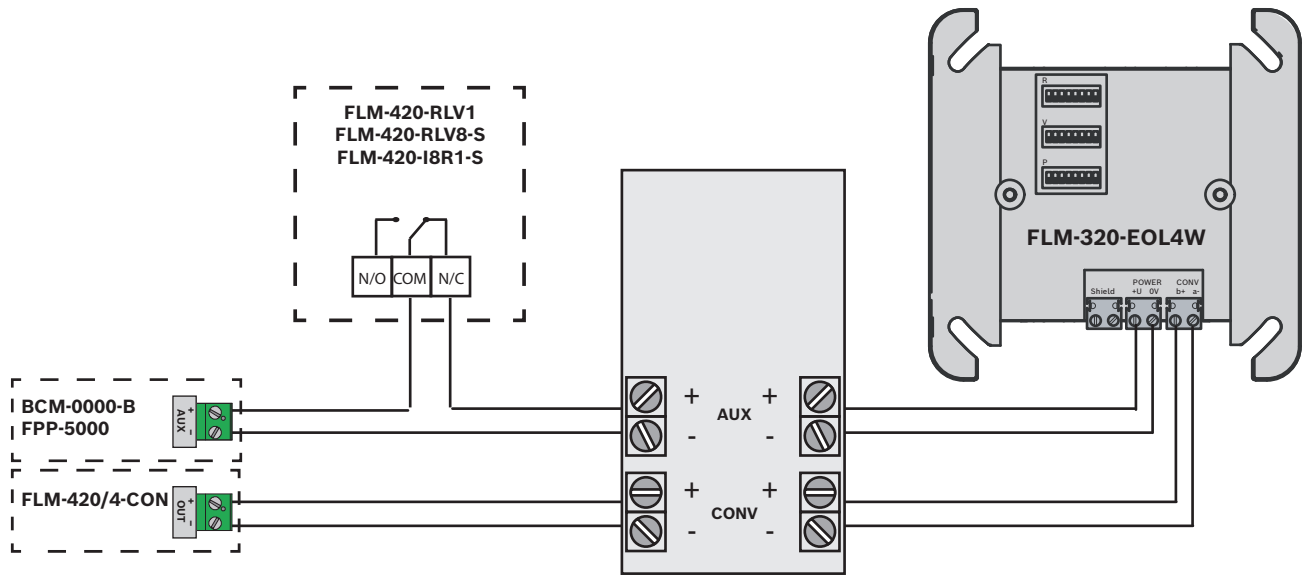

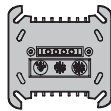
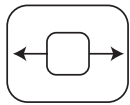

FLM-420-I2-D
 FLM-420-O1I1-D
 FLM-420-RHV-D/S
 FLM-420-RLV1-D

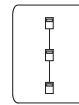

ELS

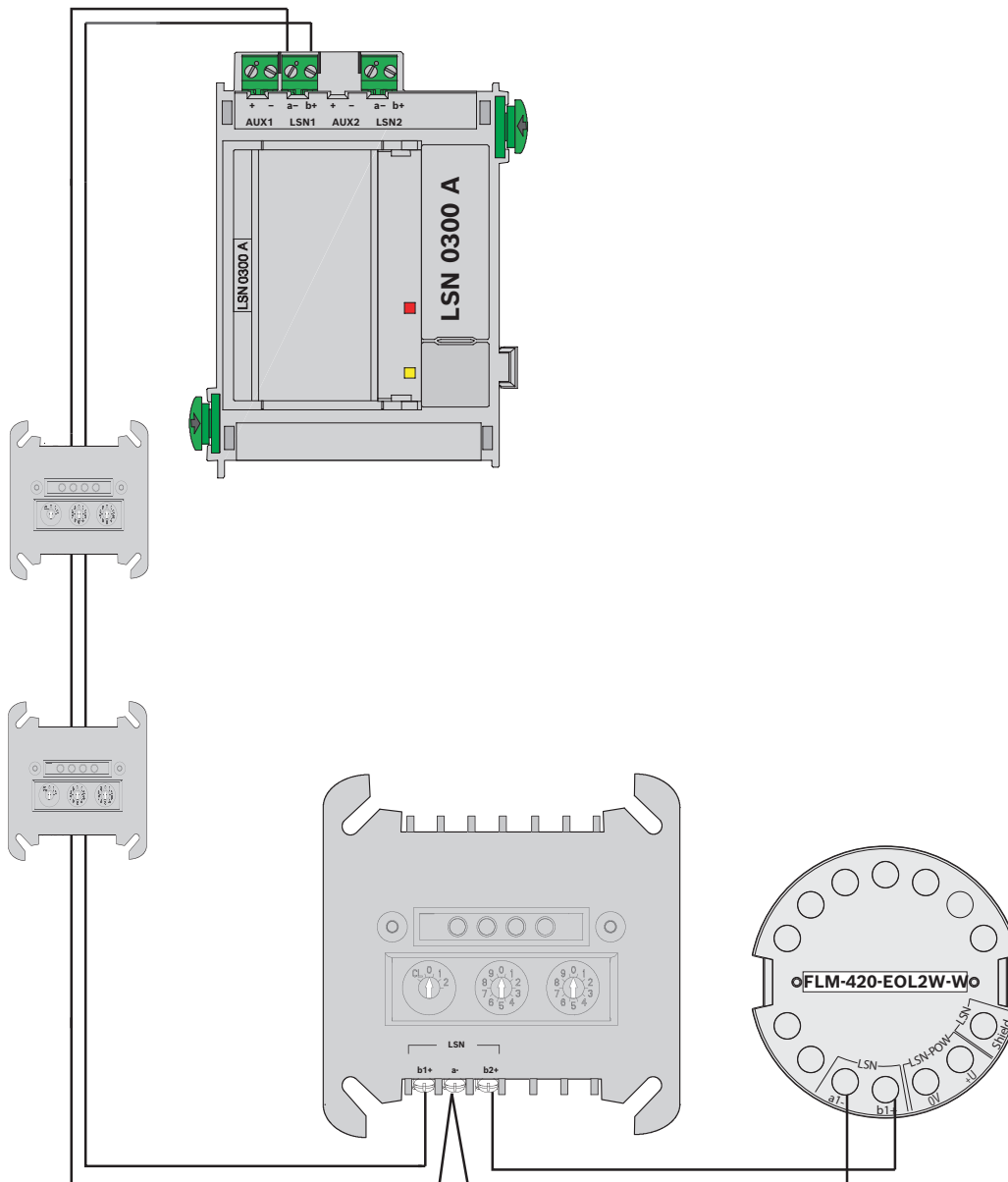

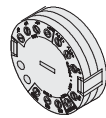
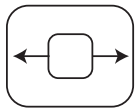

FLM-420-12-E/W

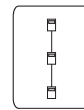

ELS

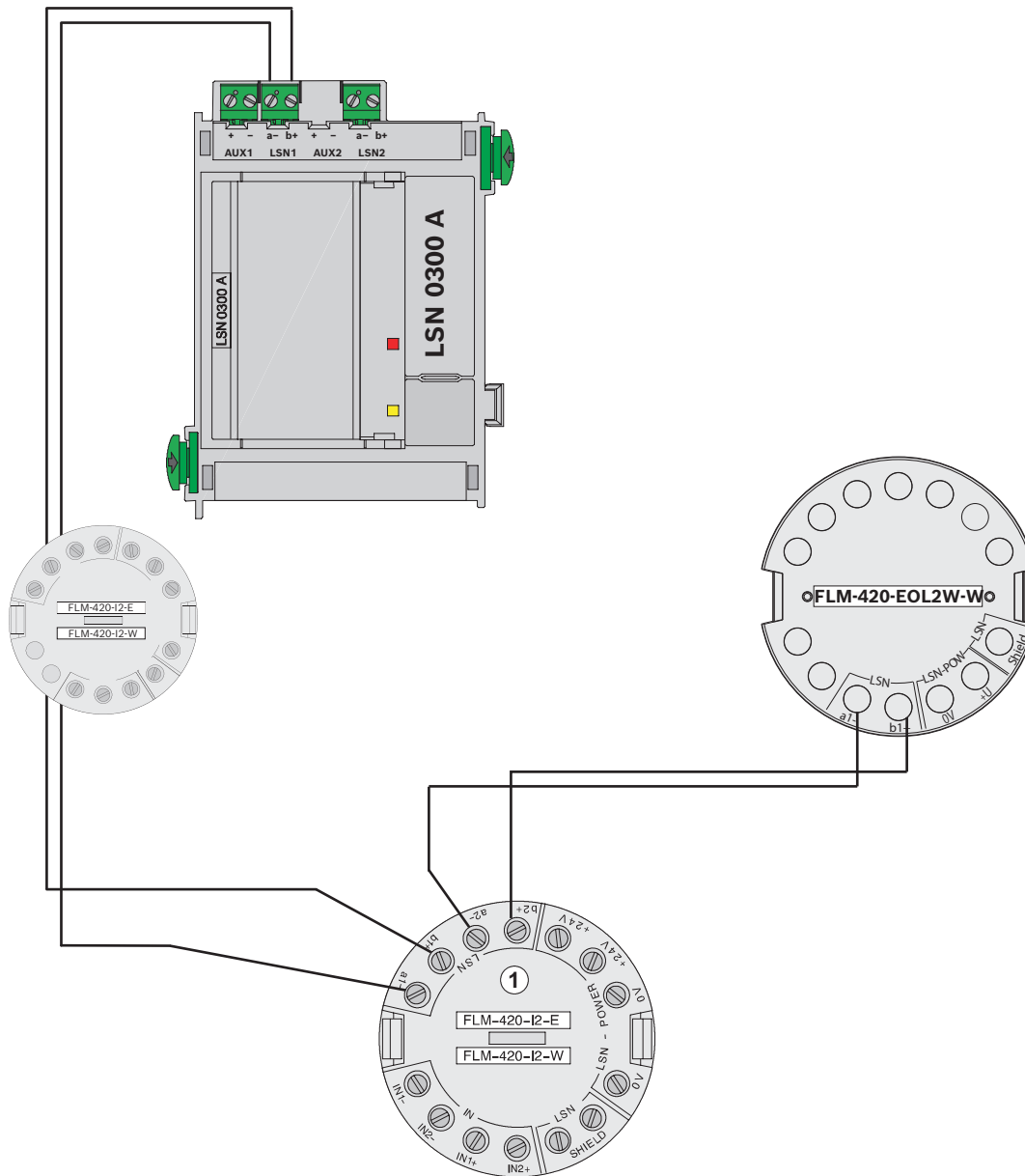

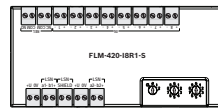
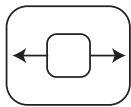

FLM-420-I8R1-S

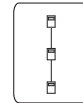

ELS

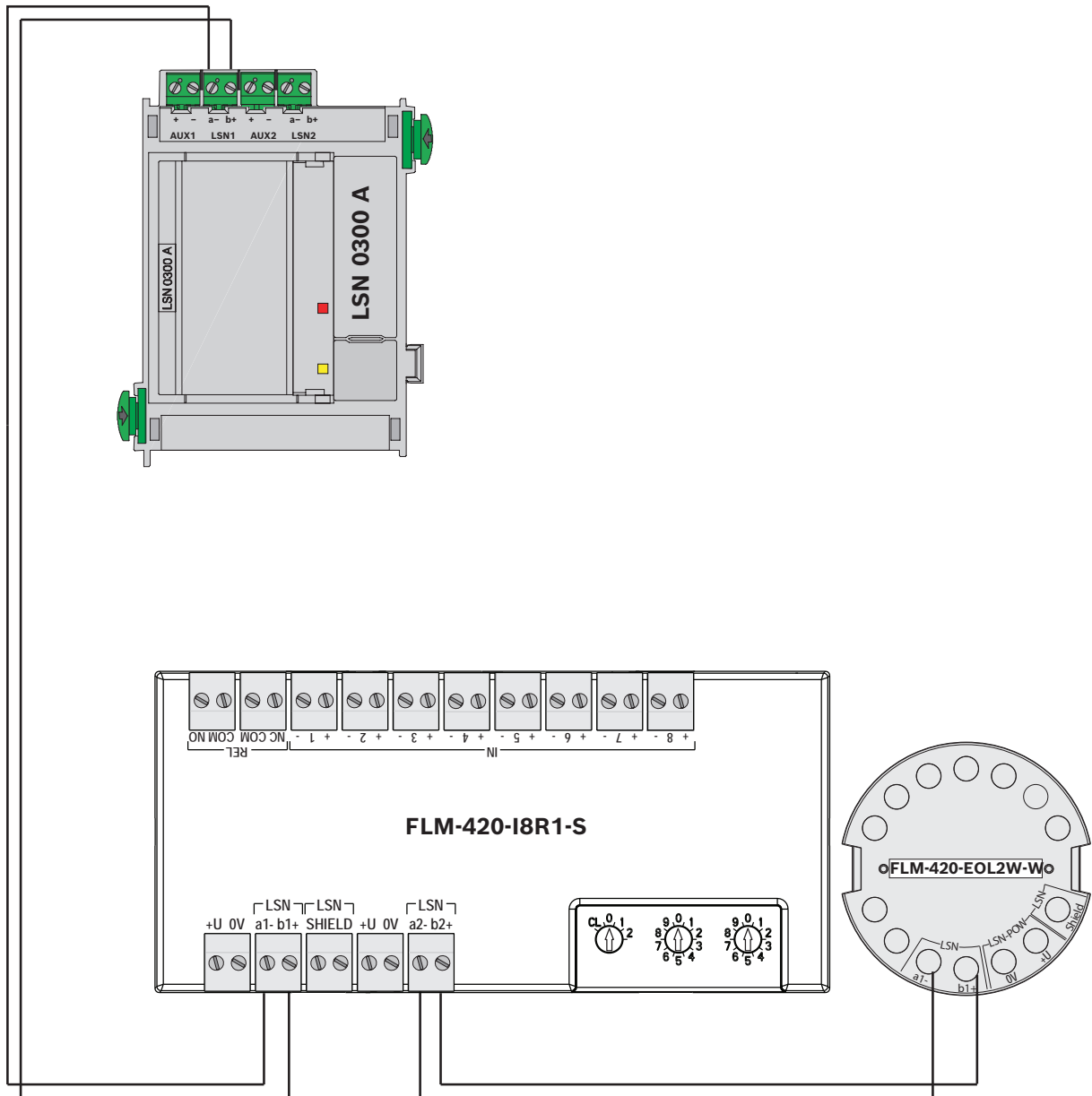

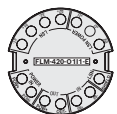
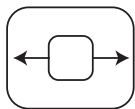

FLM-420-O1I1-E

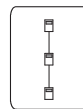

ELS

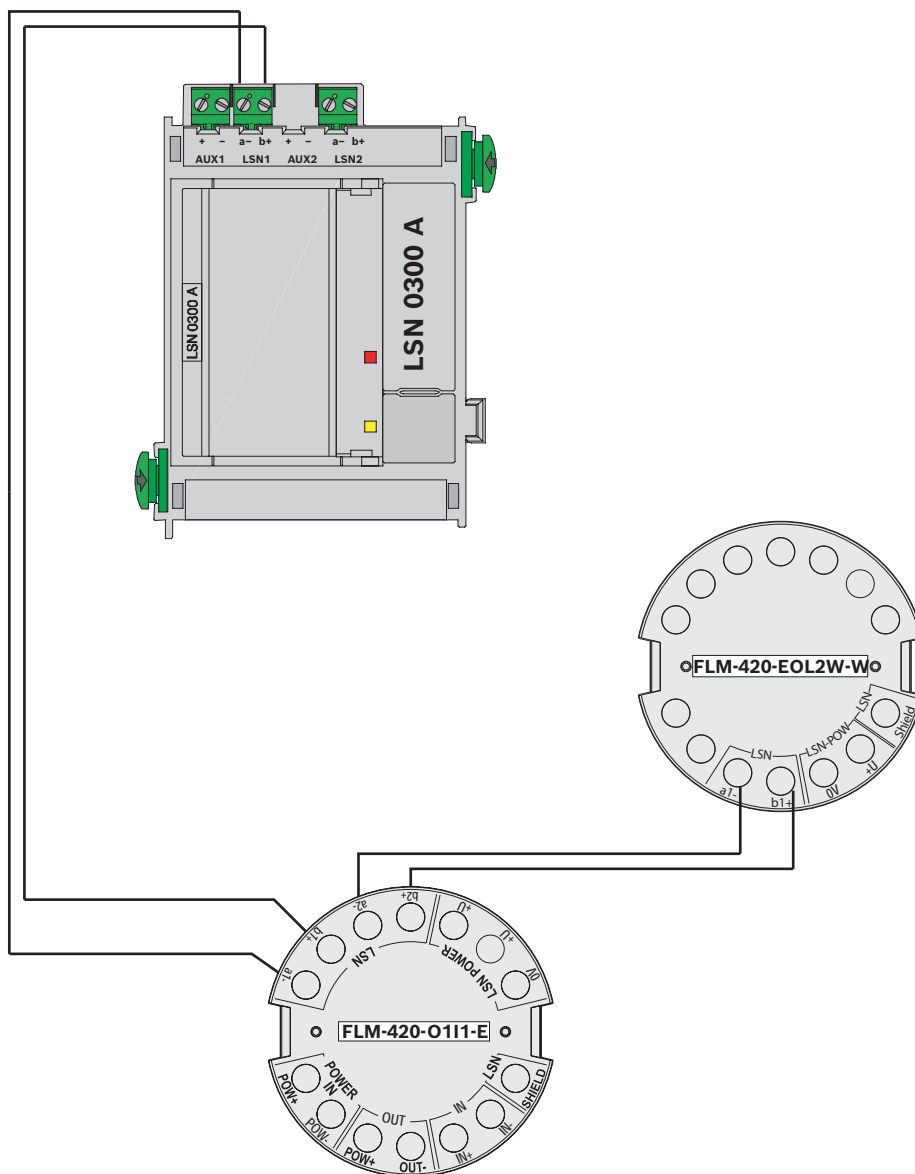

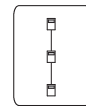
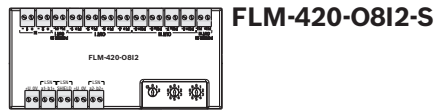
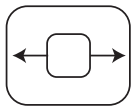

ELS

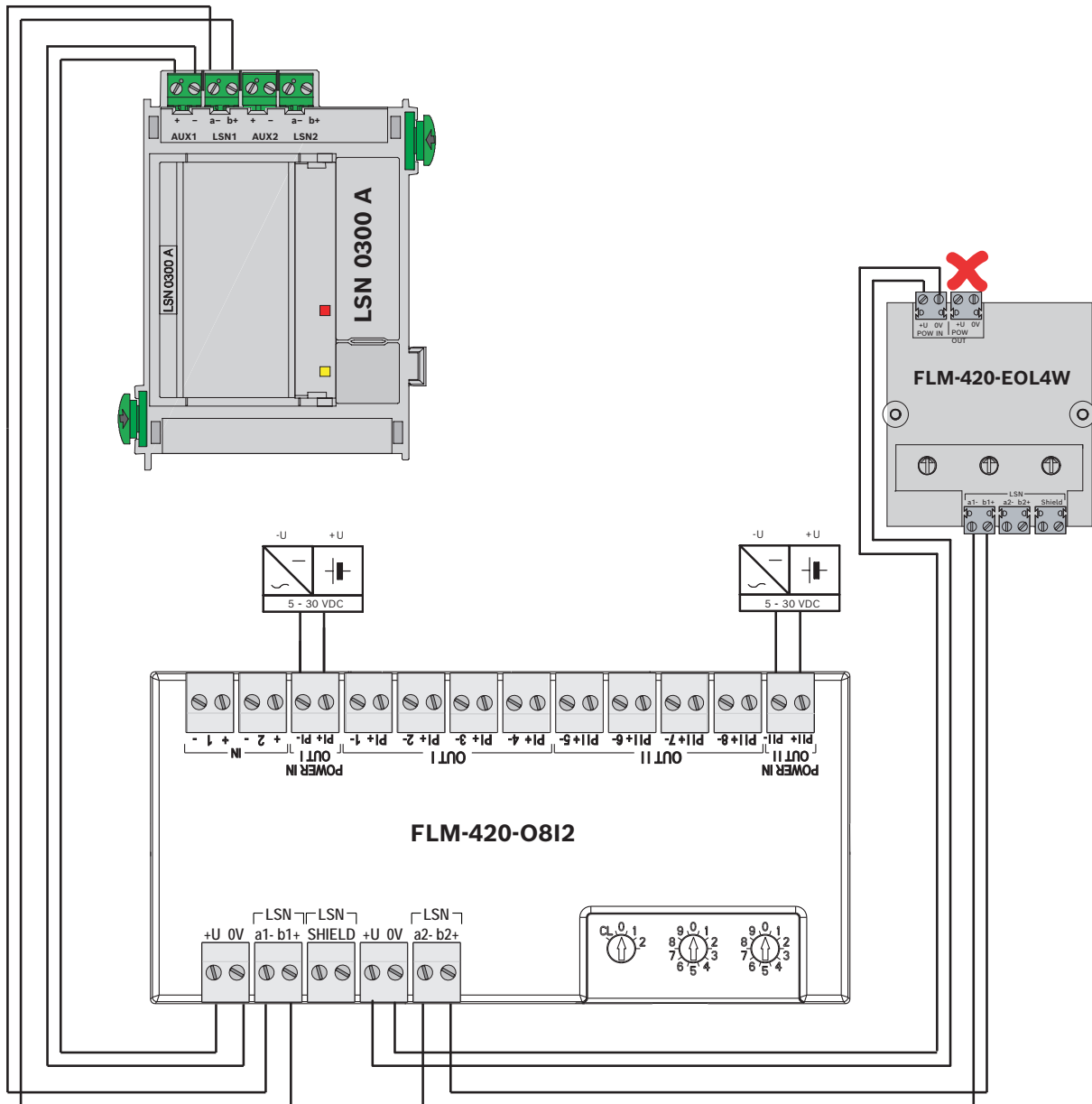

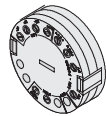
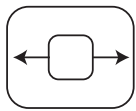

FLM-420-I2-E/-W
FLM-420-RLV1-E

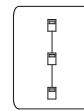

ELS

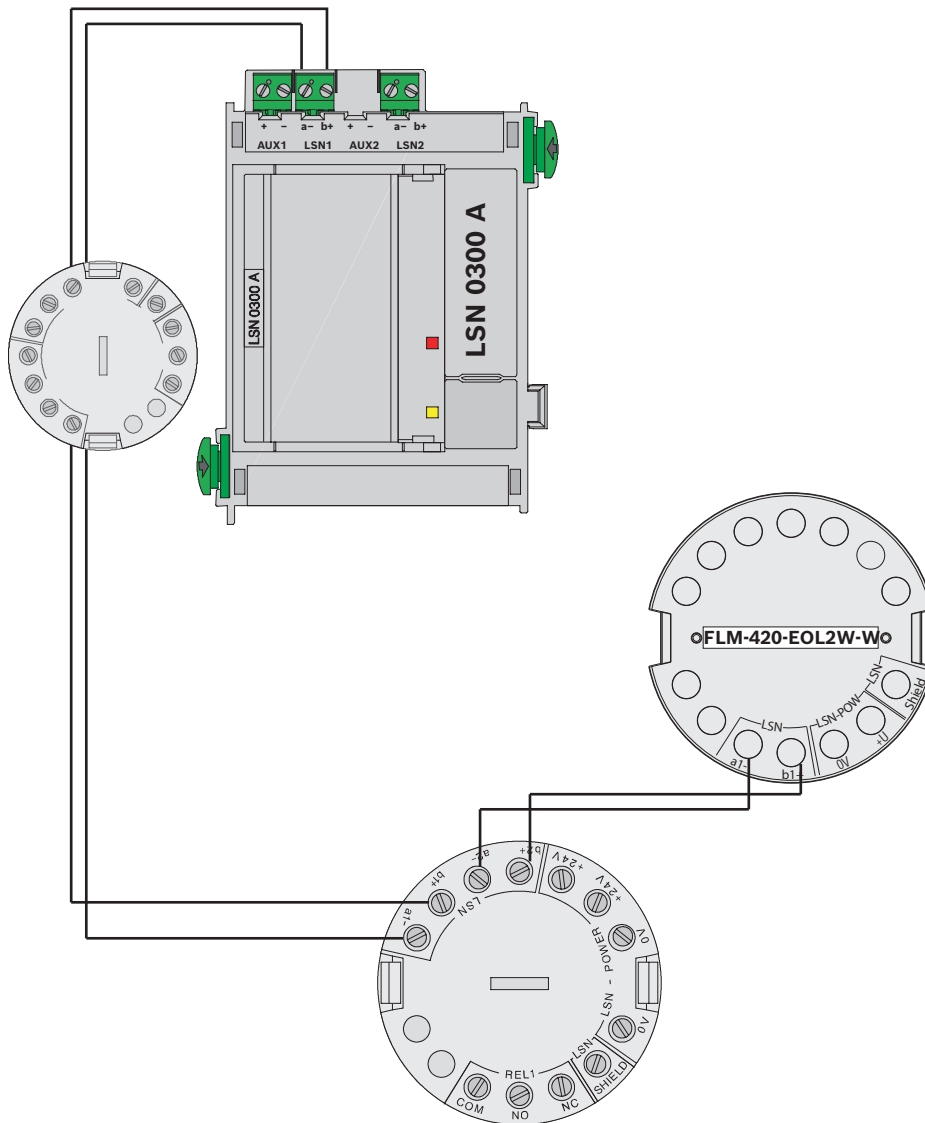

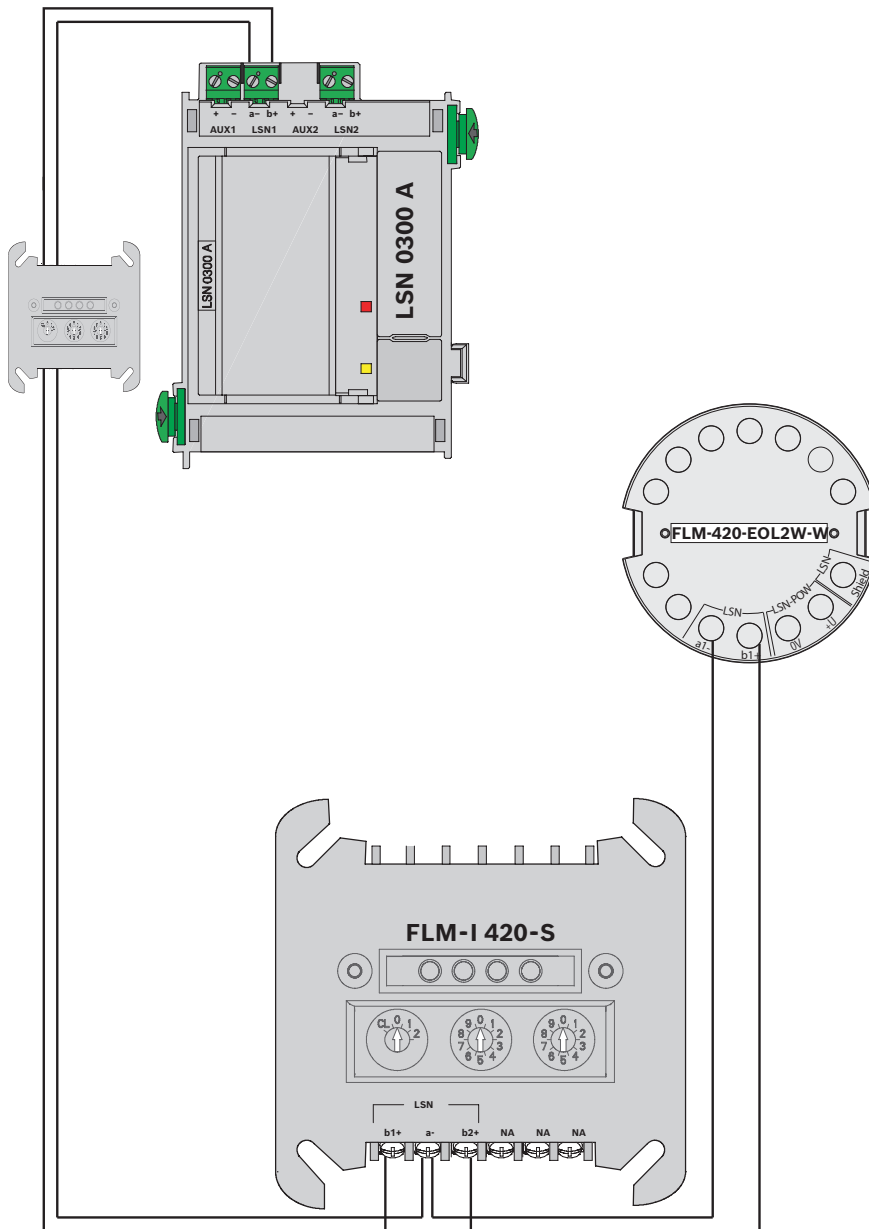
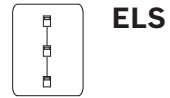
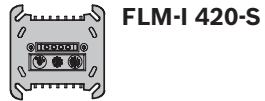
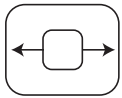

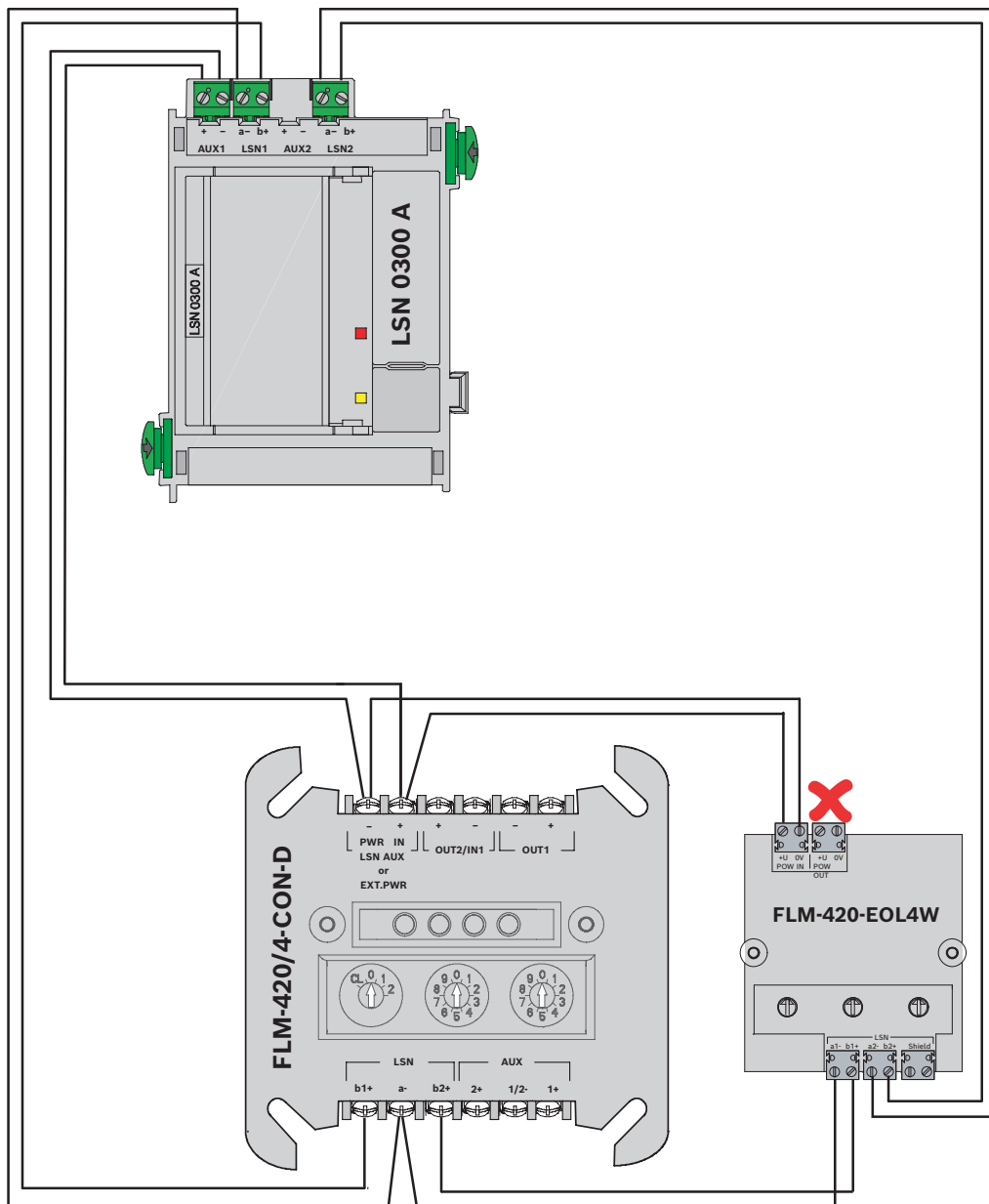
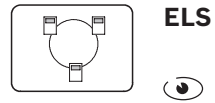
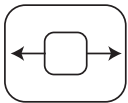

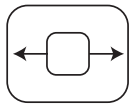

**FLM-420/
4-CON-D**

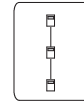

ELS

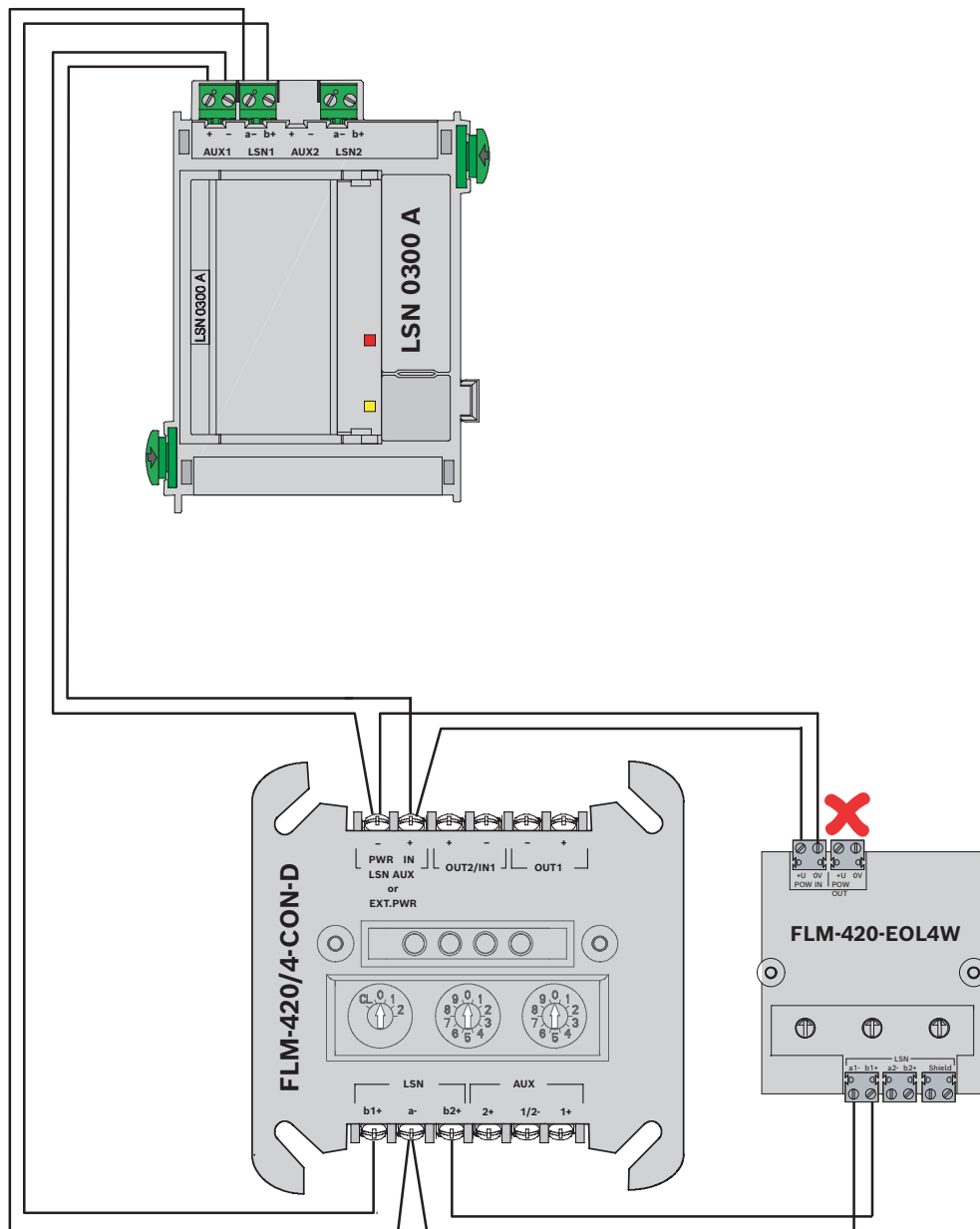

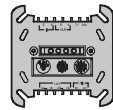
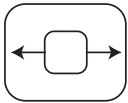

FLM-420-NAC-D/S

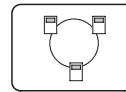

ELS
EN 54-2

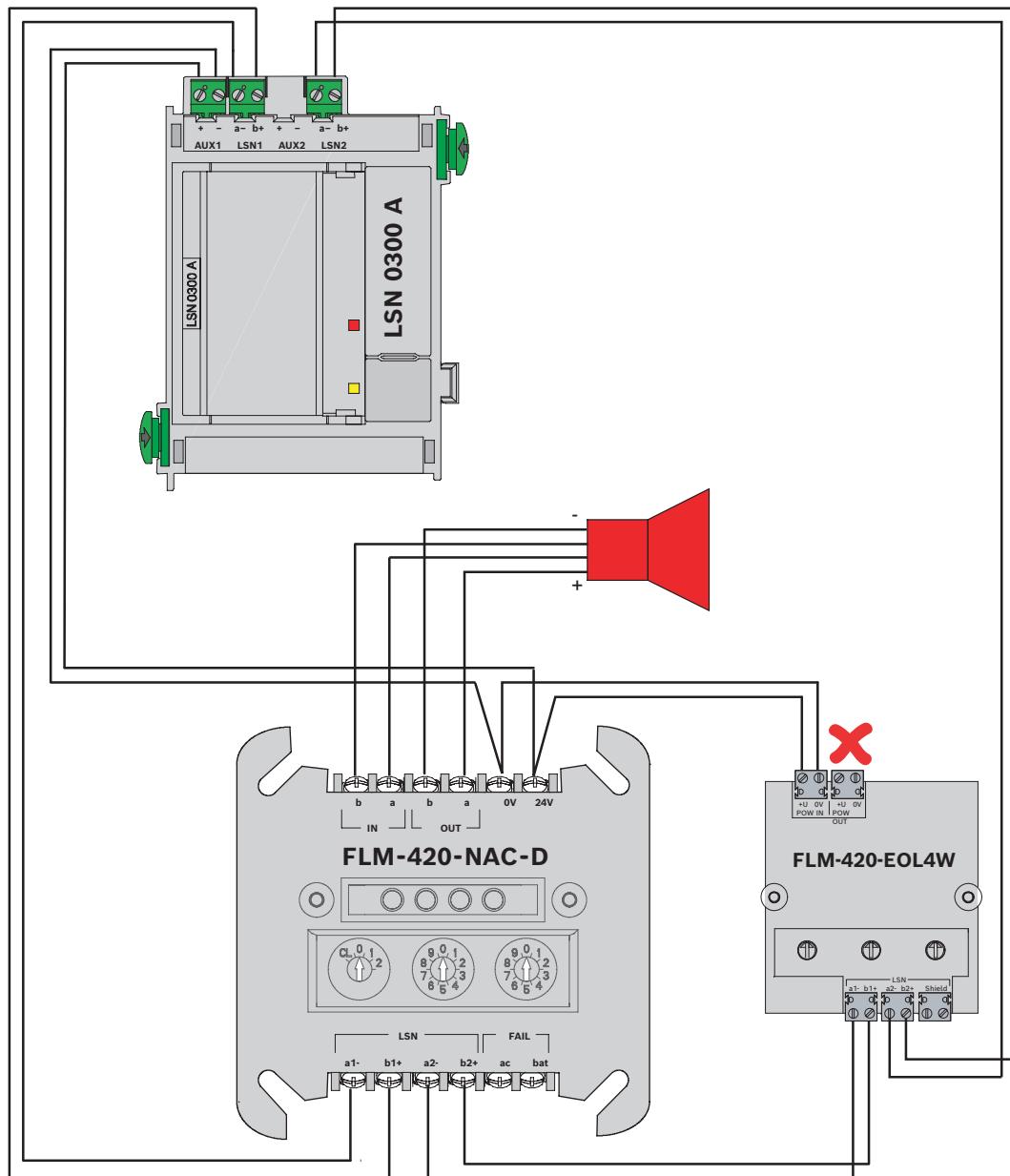

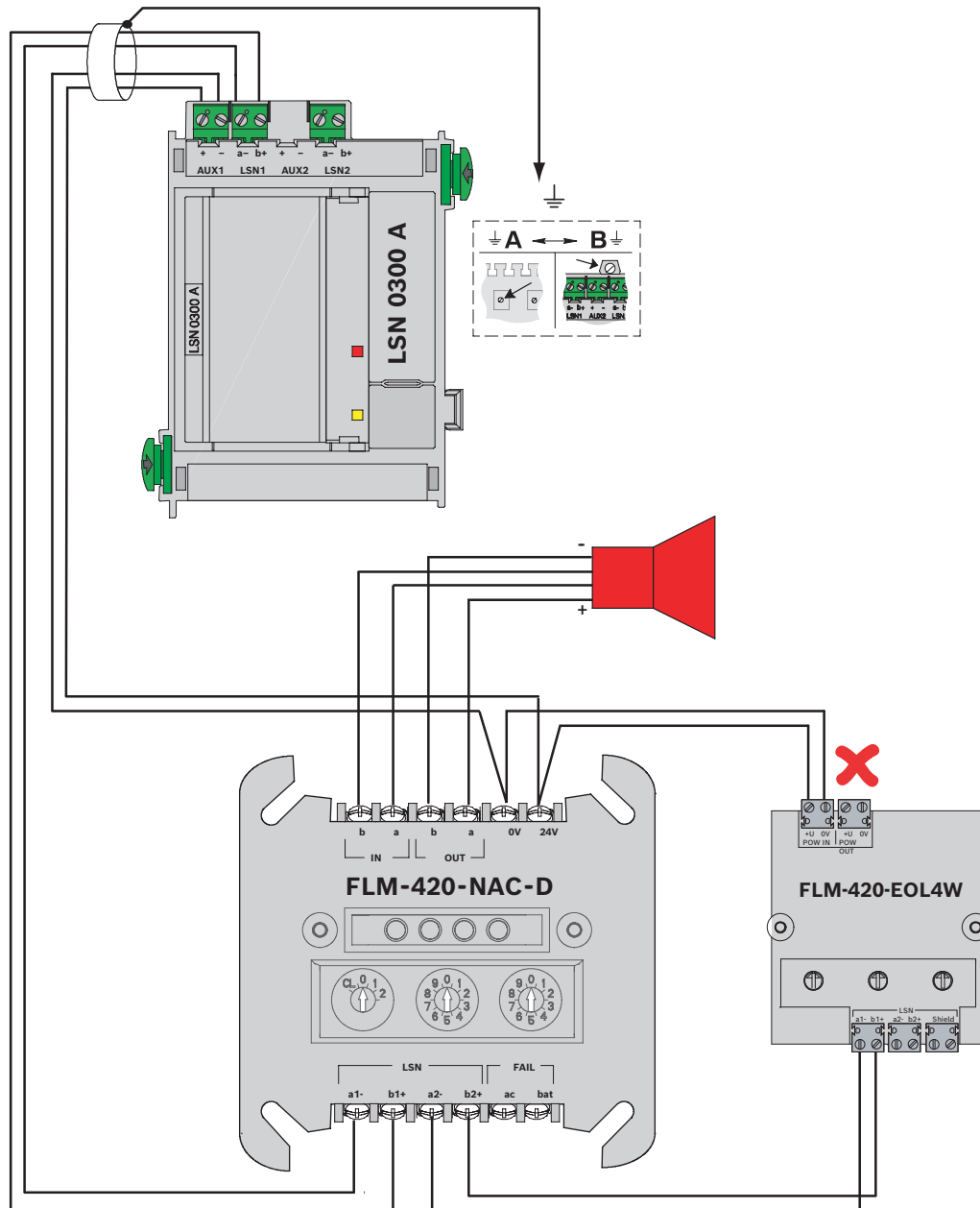
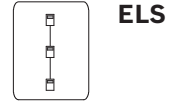
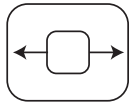

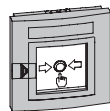

FMC-210...

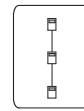

ELS

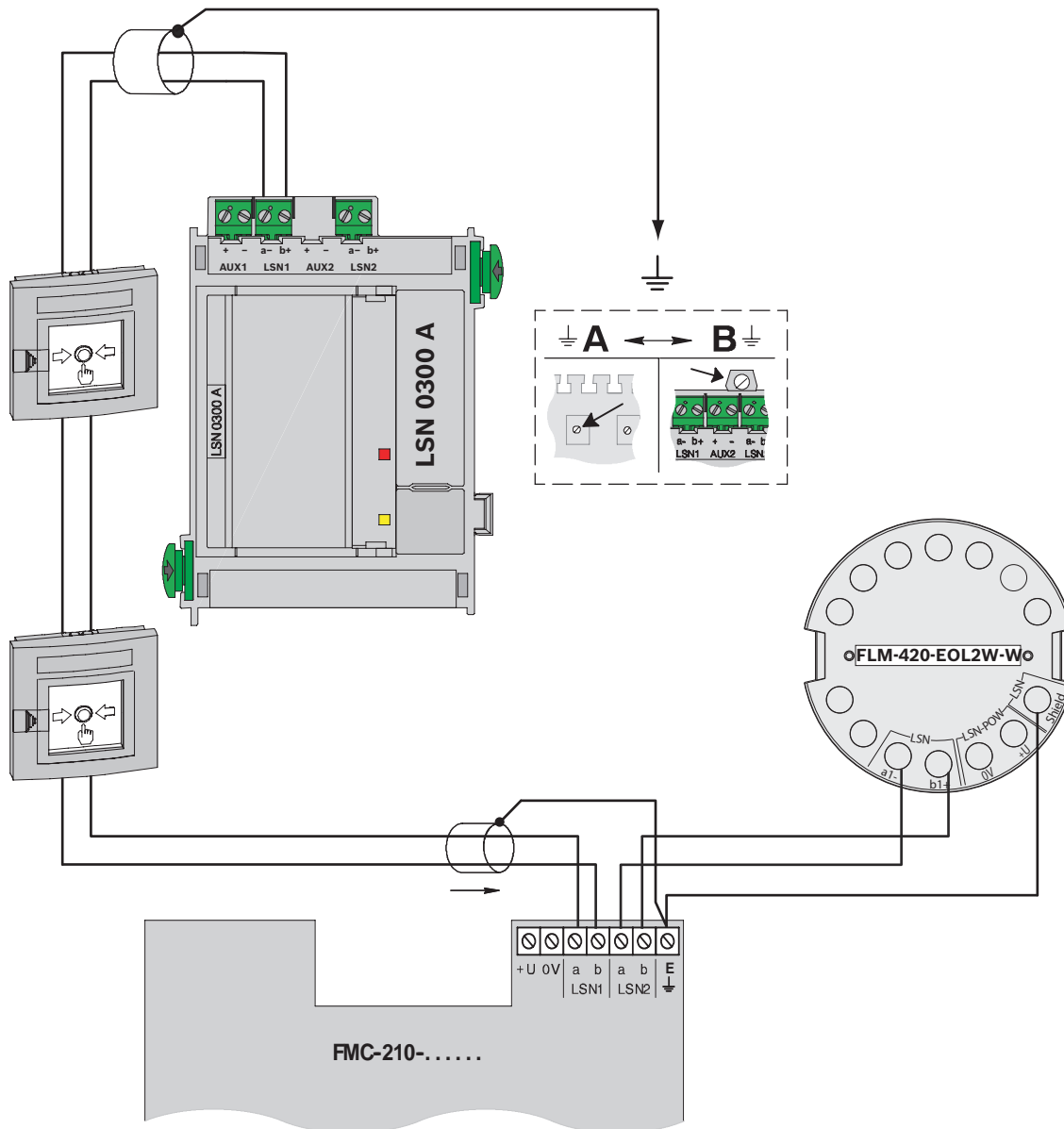

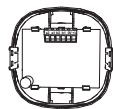

FNM-420-A /-B
FNM-420U-A /-B
FNM-420V-A

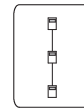

ELS

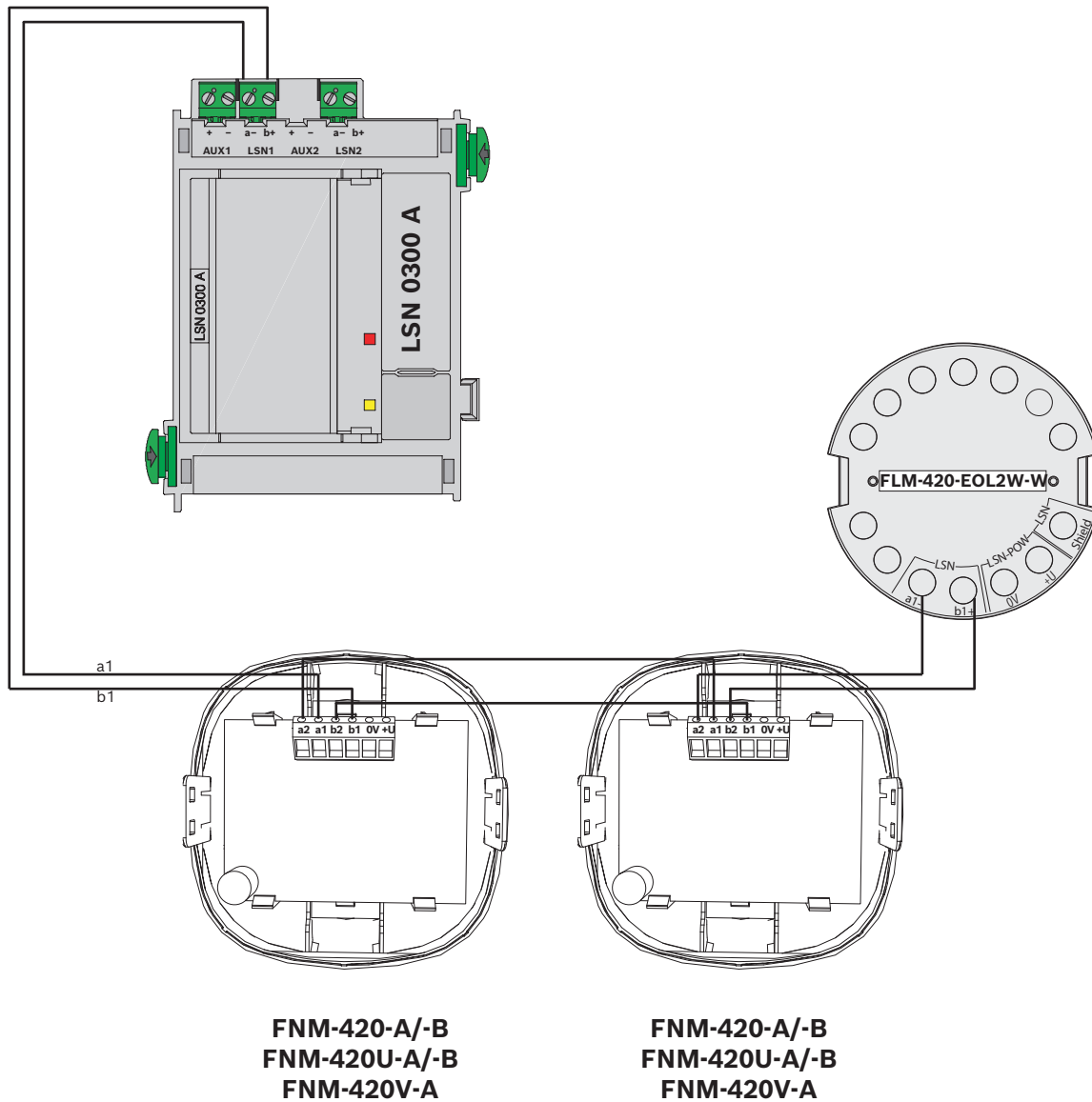



FNM-420-A-BS
FNM-420U-A-BS



ELS

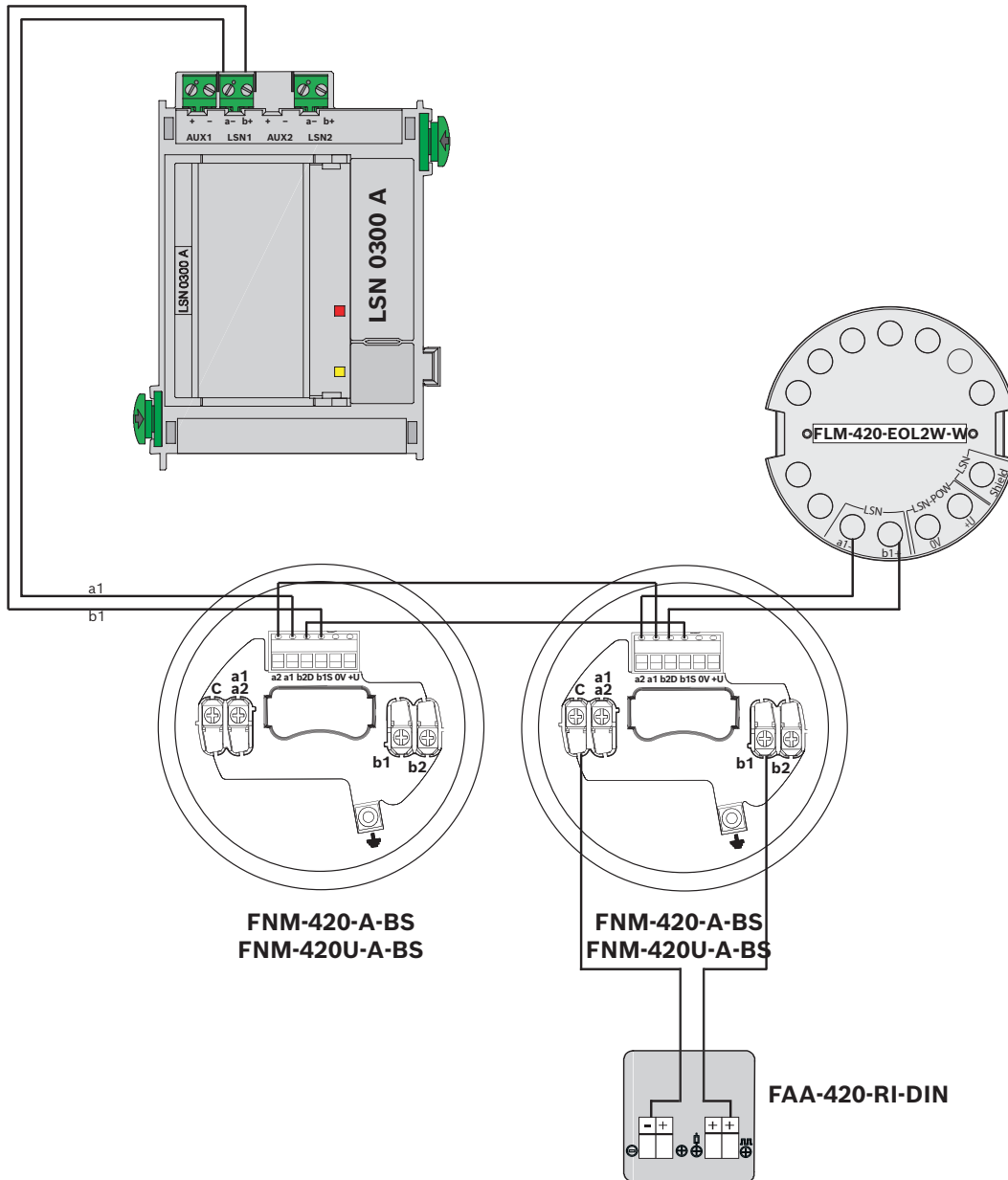



FNM-420-A-BS
FNM-420U-A-BS



ELS

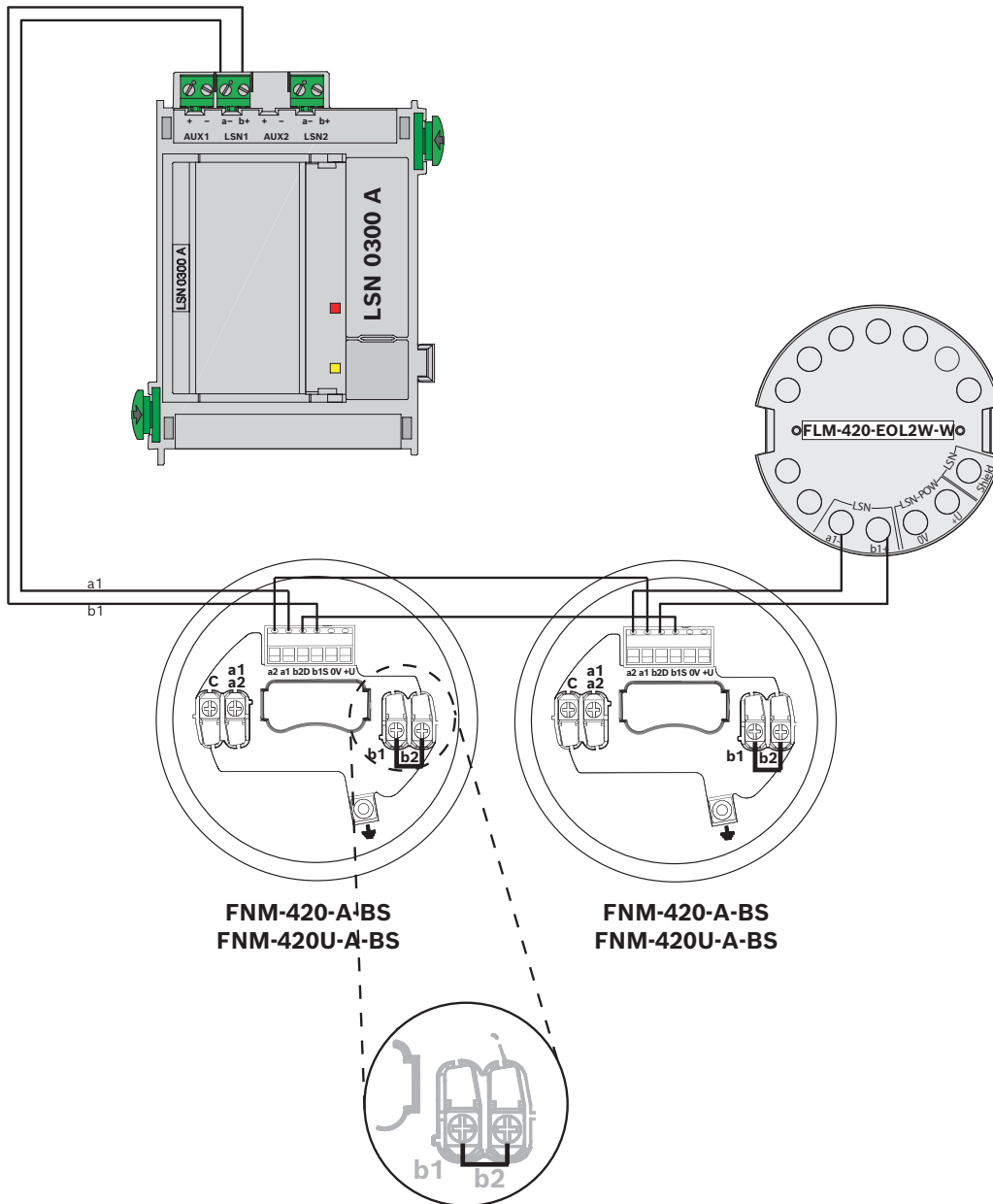

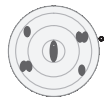

FAP-0520
FAP-0520-P
FAP-OC520
FAP-OC-520-P



ELS

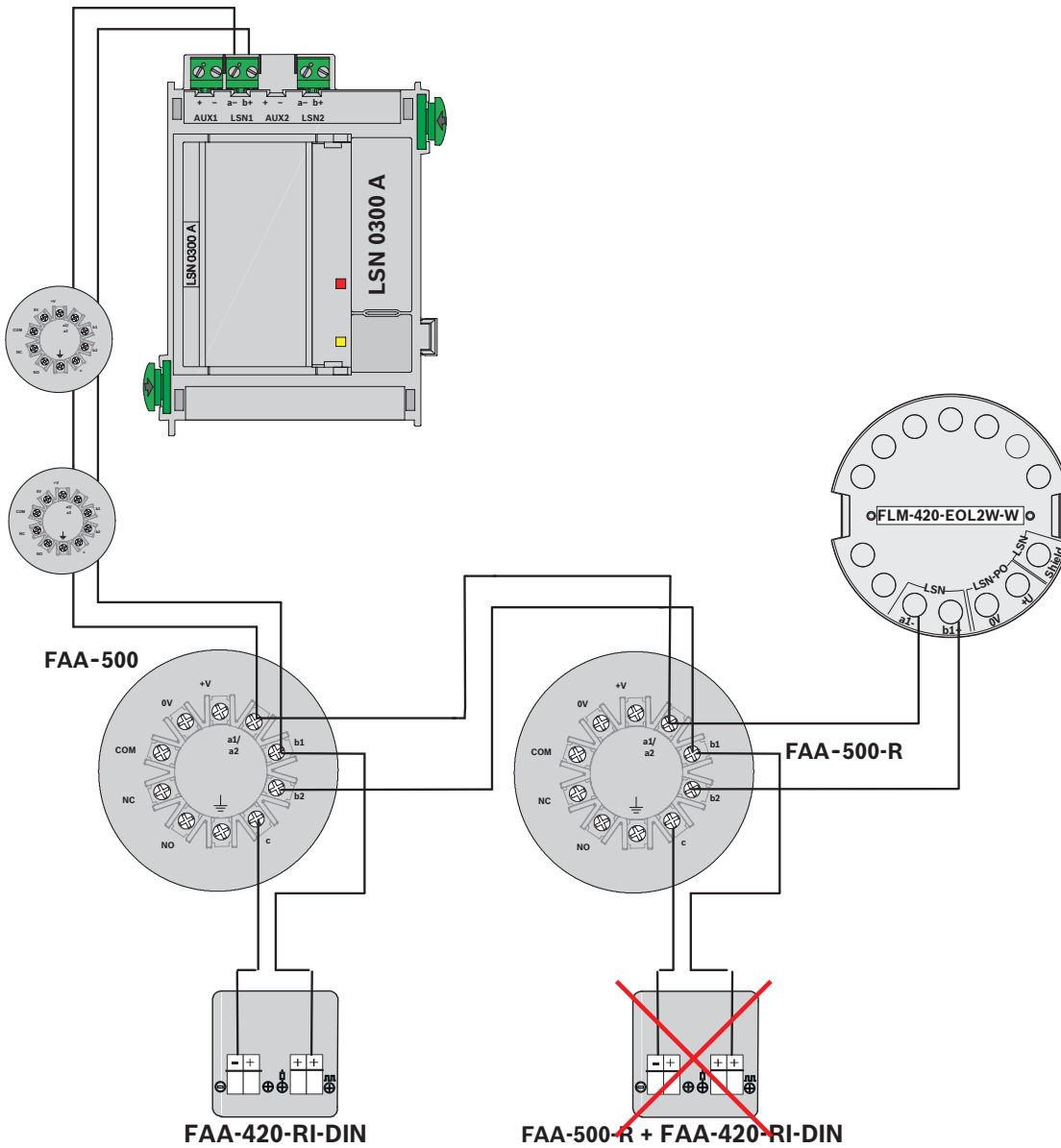

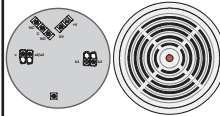

FAA-MSR-420
FAP-425-O, FAP-425-O-R
FAP-425-OT, FAP-425-OT-R
FAP-425-T-R
FAP-425-DO-R, FAP-425-DOT-R
FAP-425-DOTC-R, FAP-425-DOTCO-R

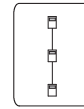

ELS

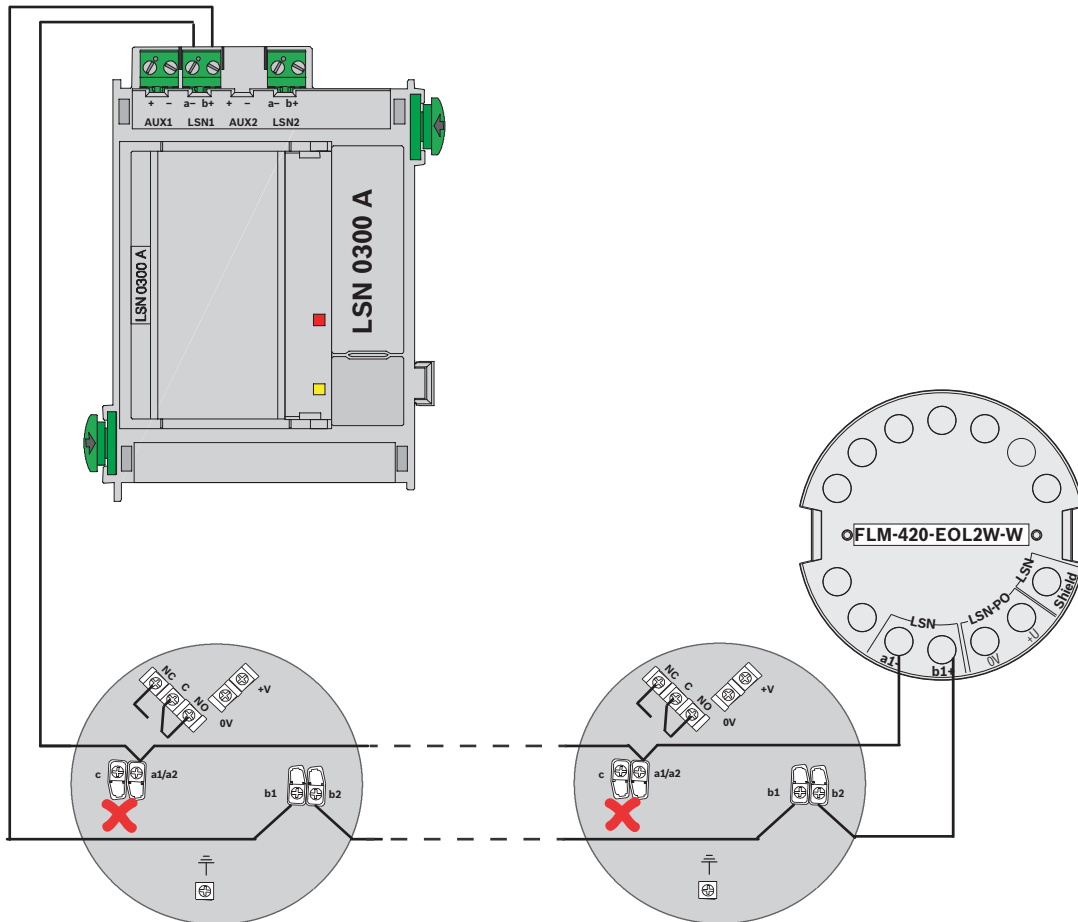

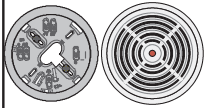

MS 400, MS 400 B
 FAP-425-O, FAP-425-O-R
 FAP-425-OT, FAP-425-OT-R
 FAP-425-T-R
 FAP-425-DO-R, FAP-425-DOT-R
 FAP-425-DOTC-R, FAP-425-DOTCO-R



ELS

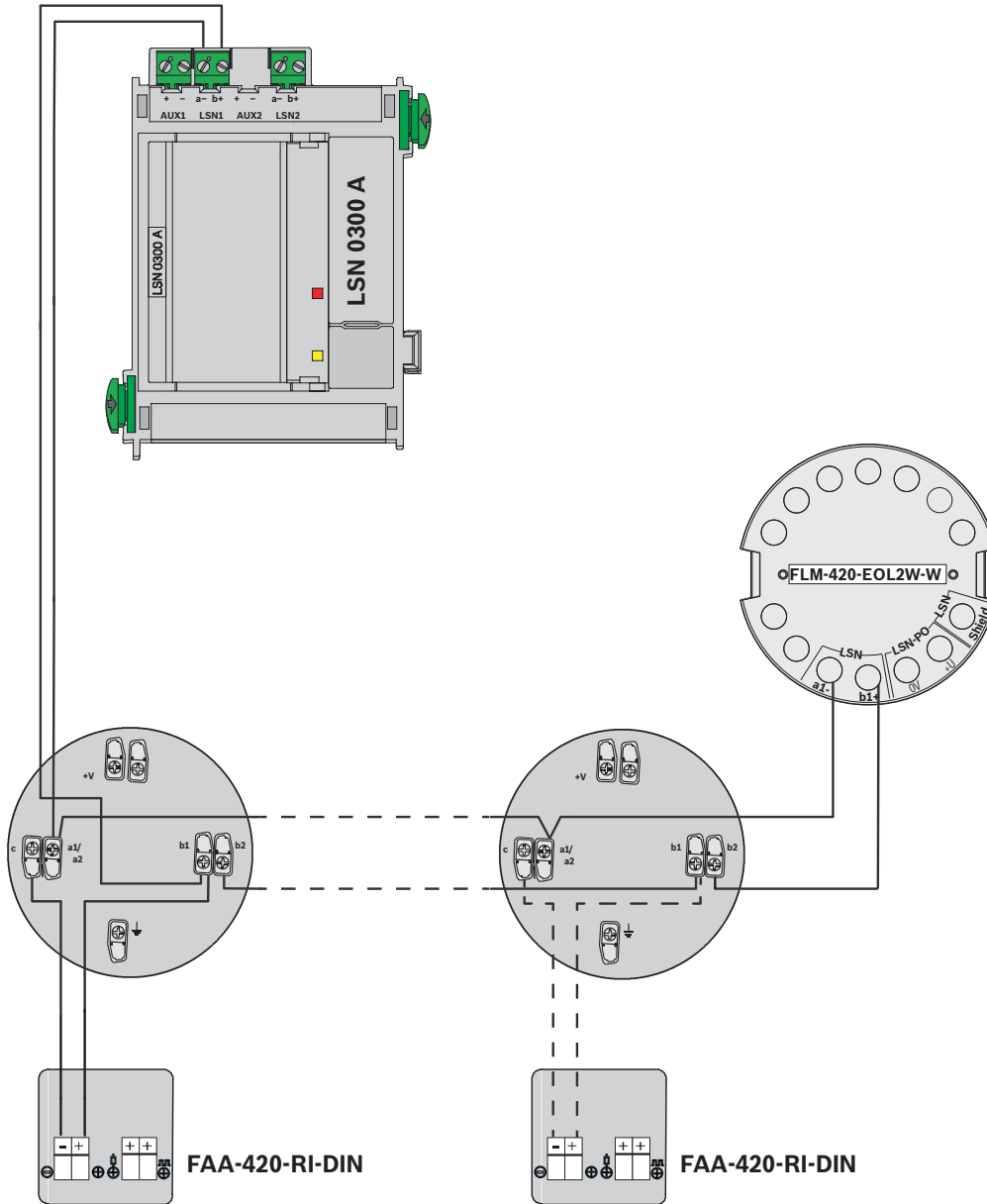

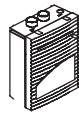

FAS-420 Series

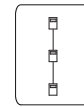

ELS

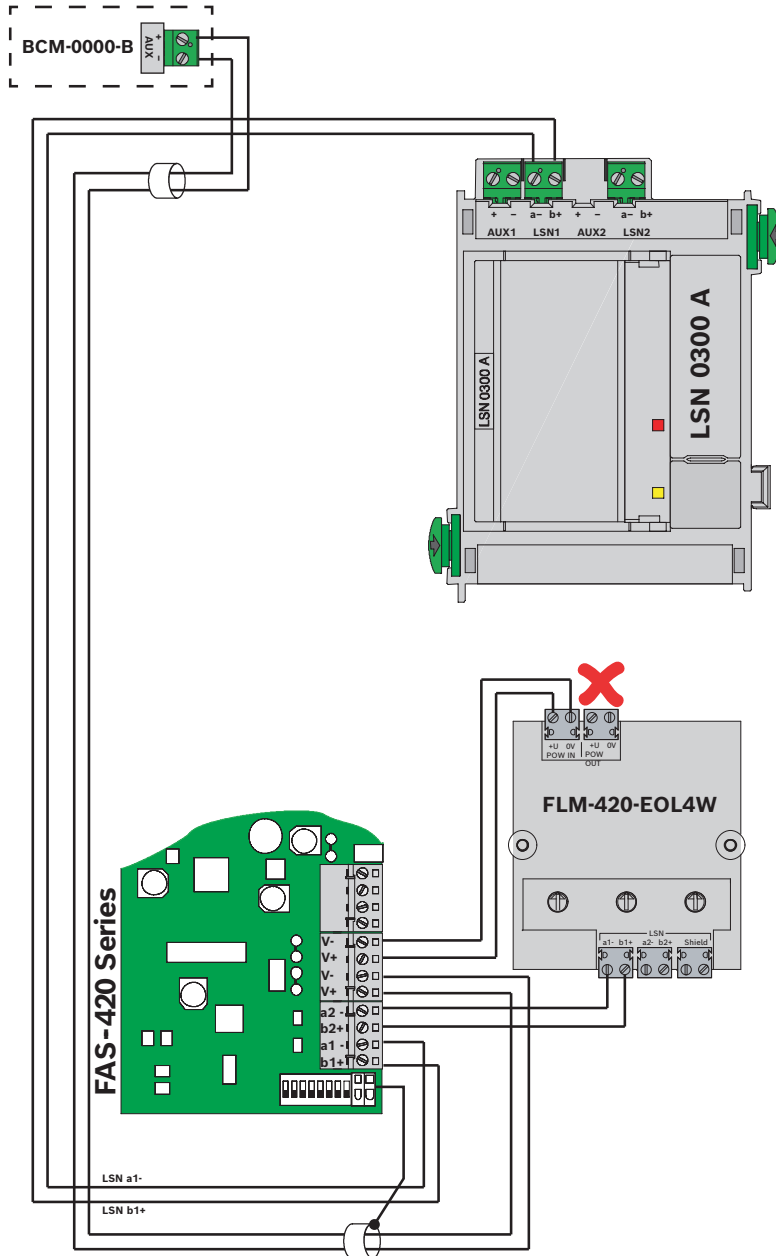

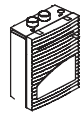

FAS-420 Series

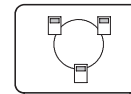

ELS

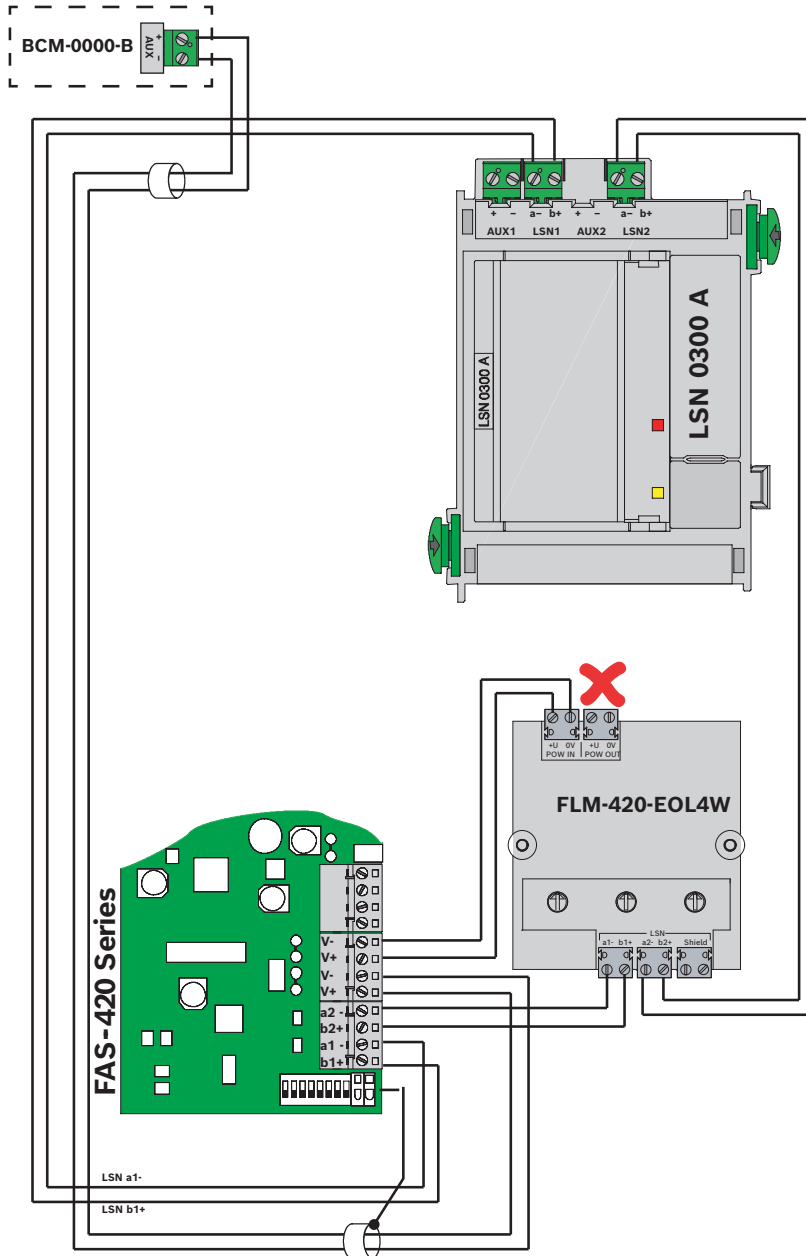

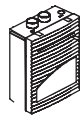

FAS-420-TM Series

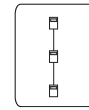

ELS

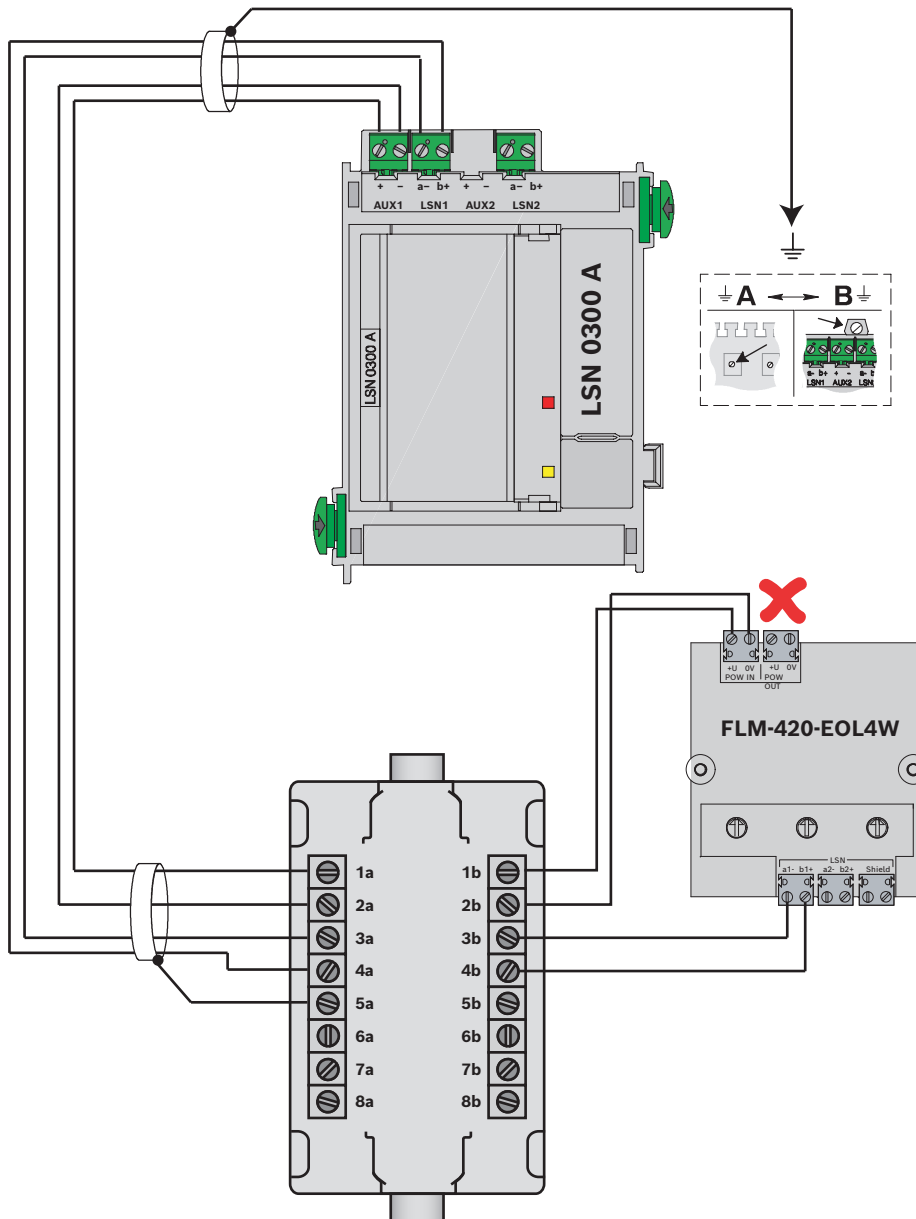

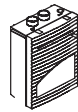

FAS-420-TM Series

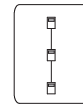

ELS

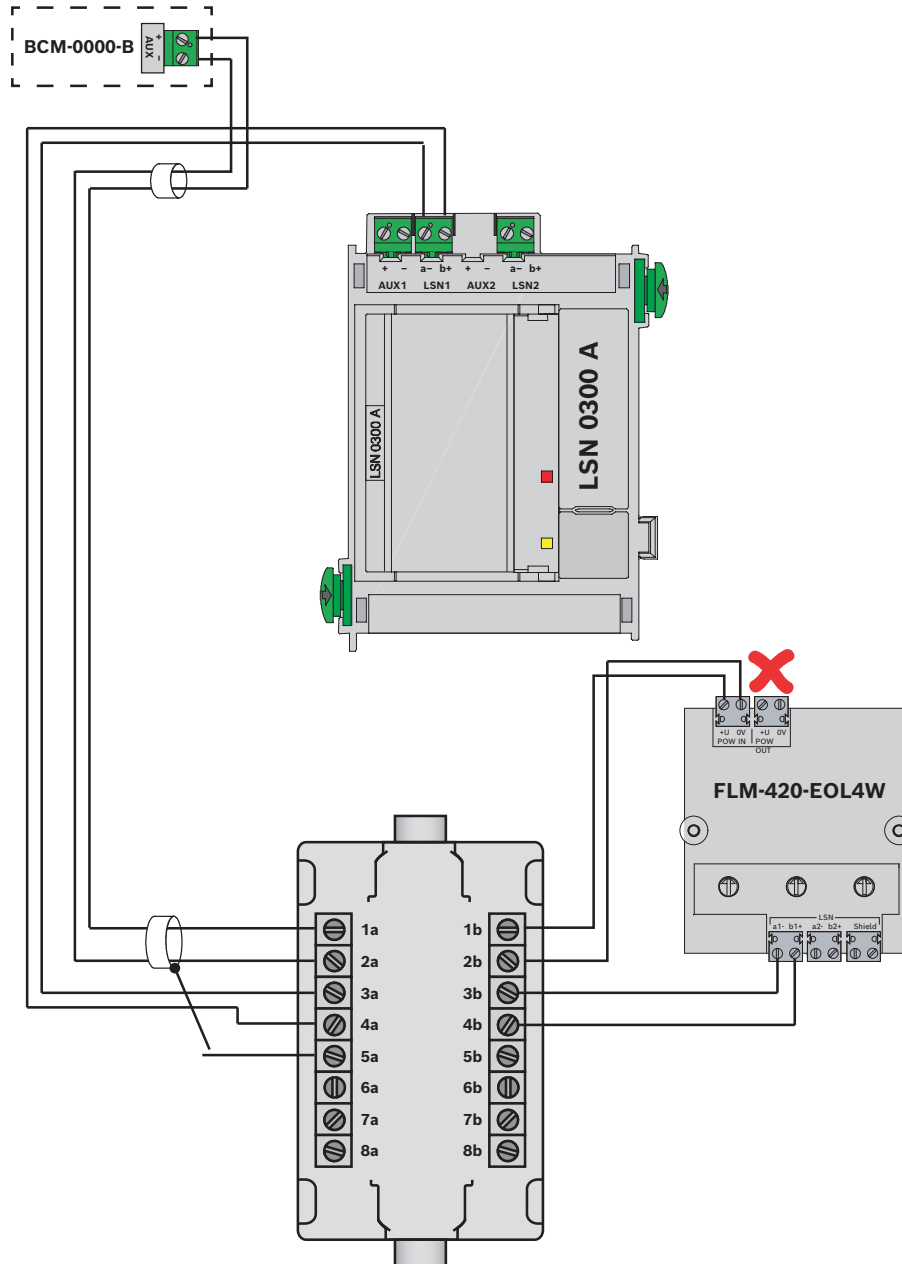

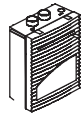

FAS-420-TM Series

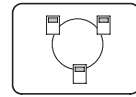

ELS

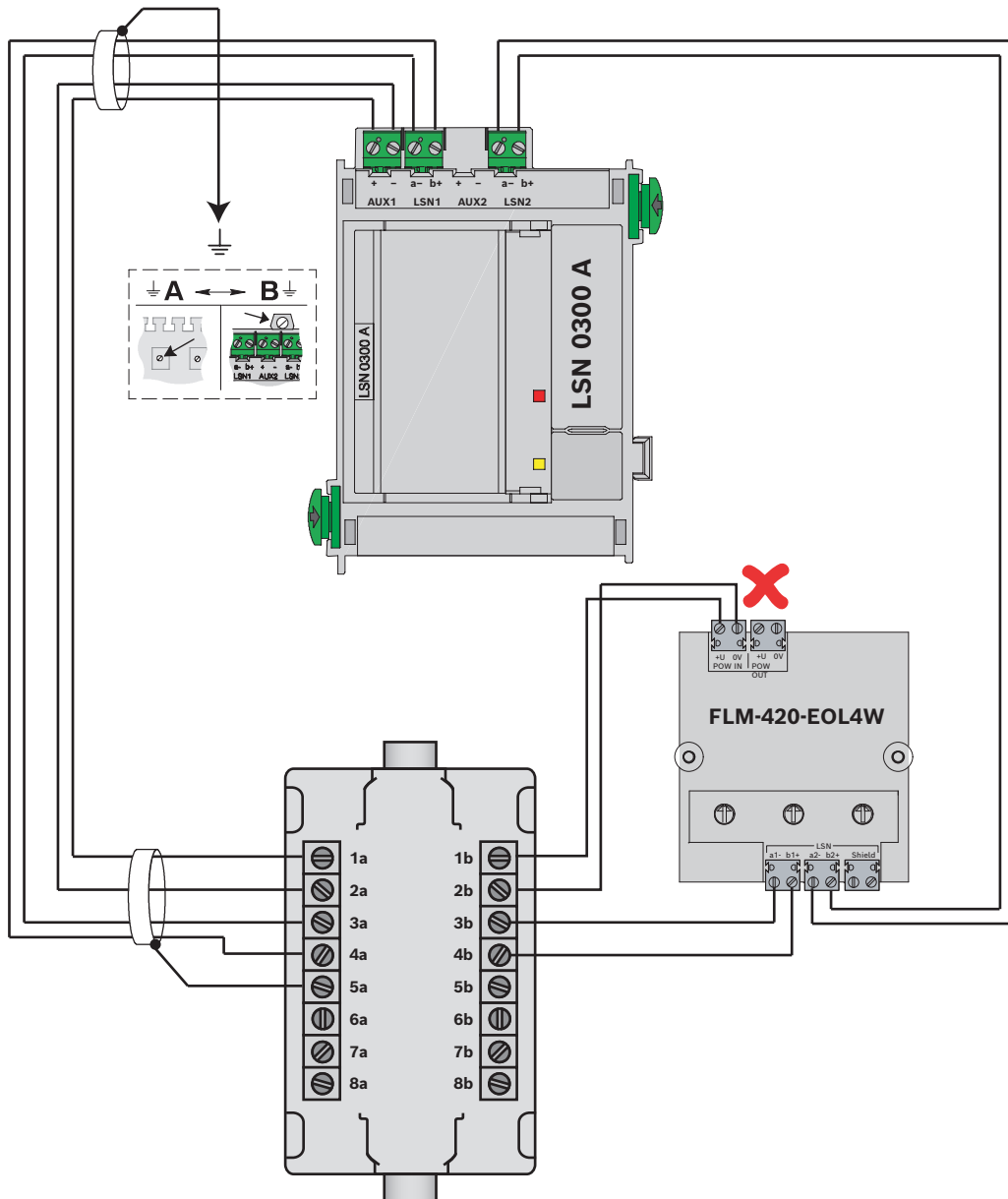

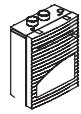

FAS-420-TM Series

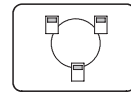

ELS

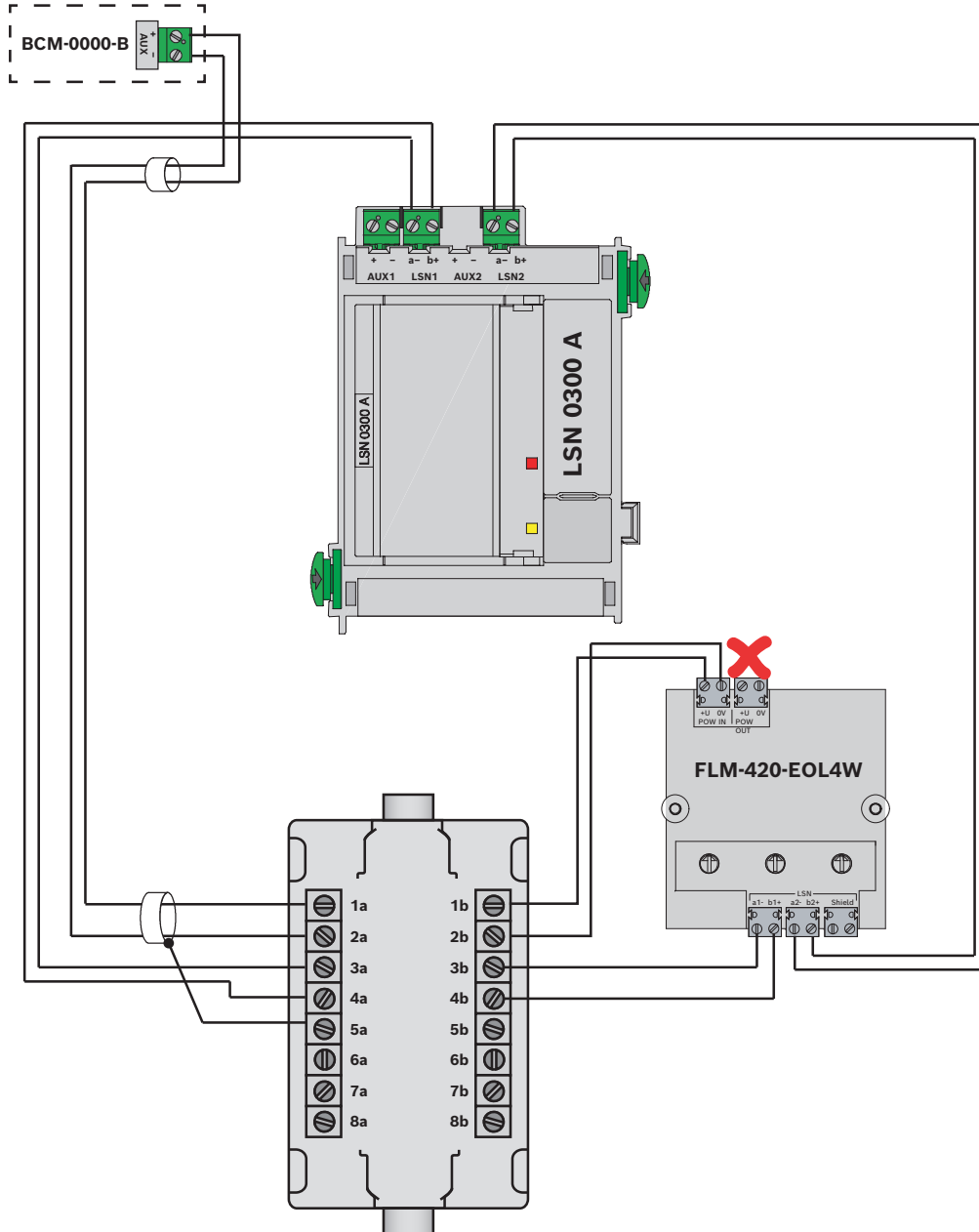



FBF 100 LSN

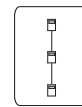

ELS

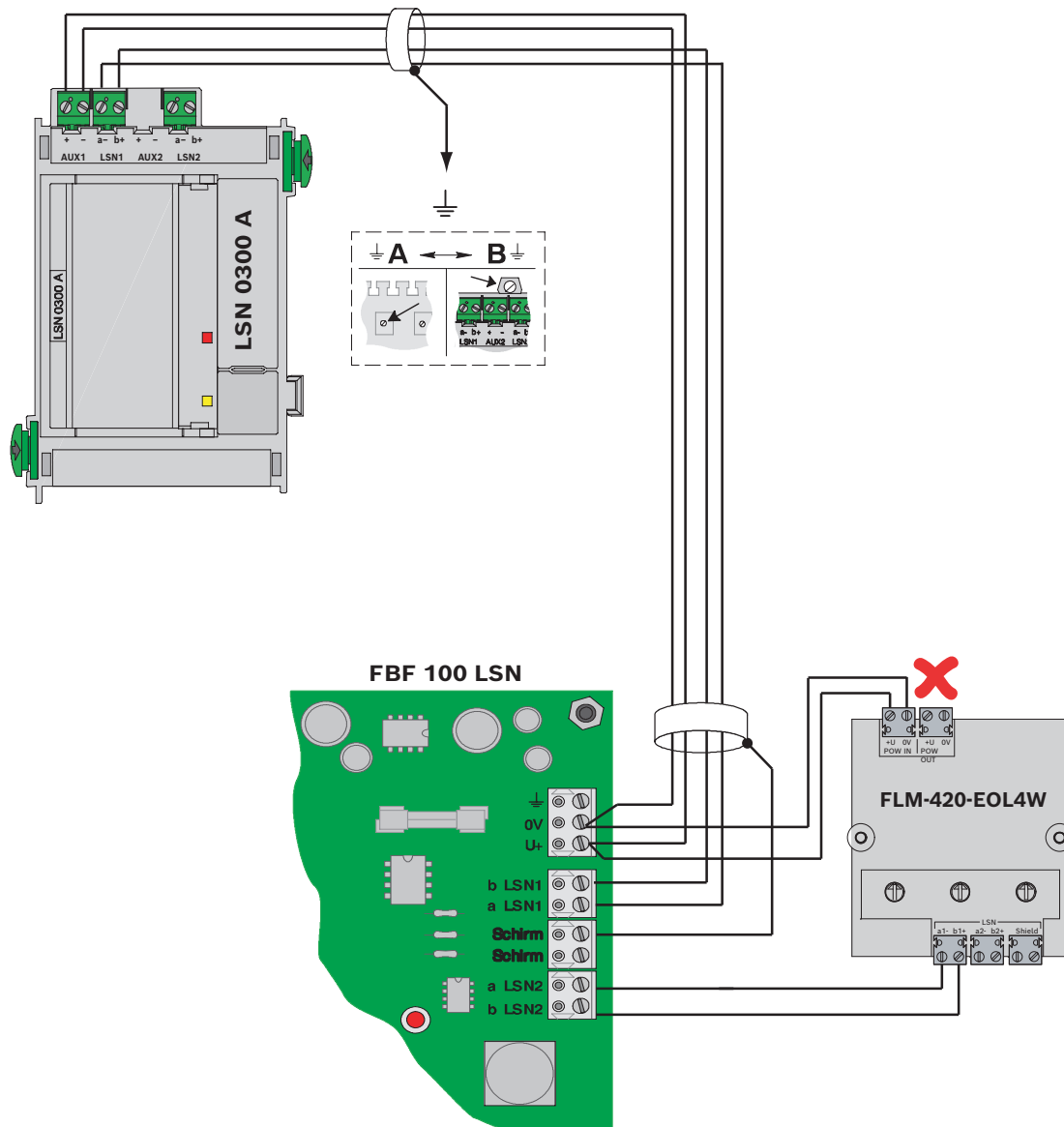



FBF 100 LSN

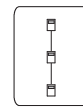

ELS

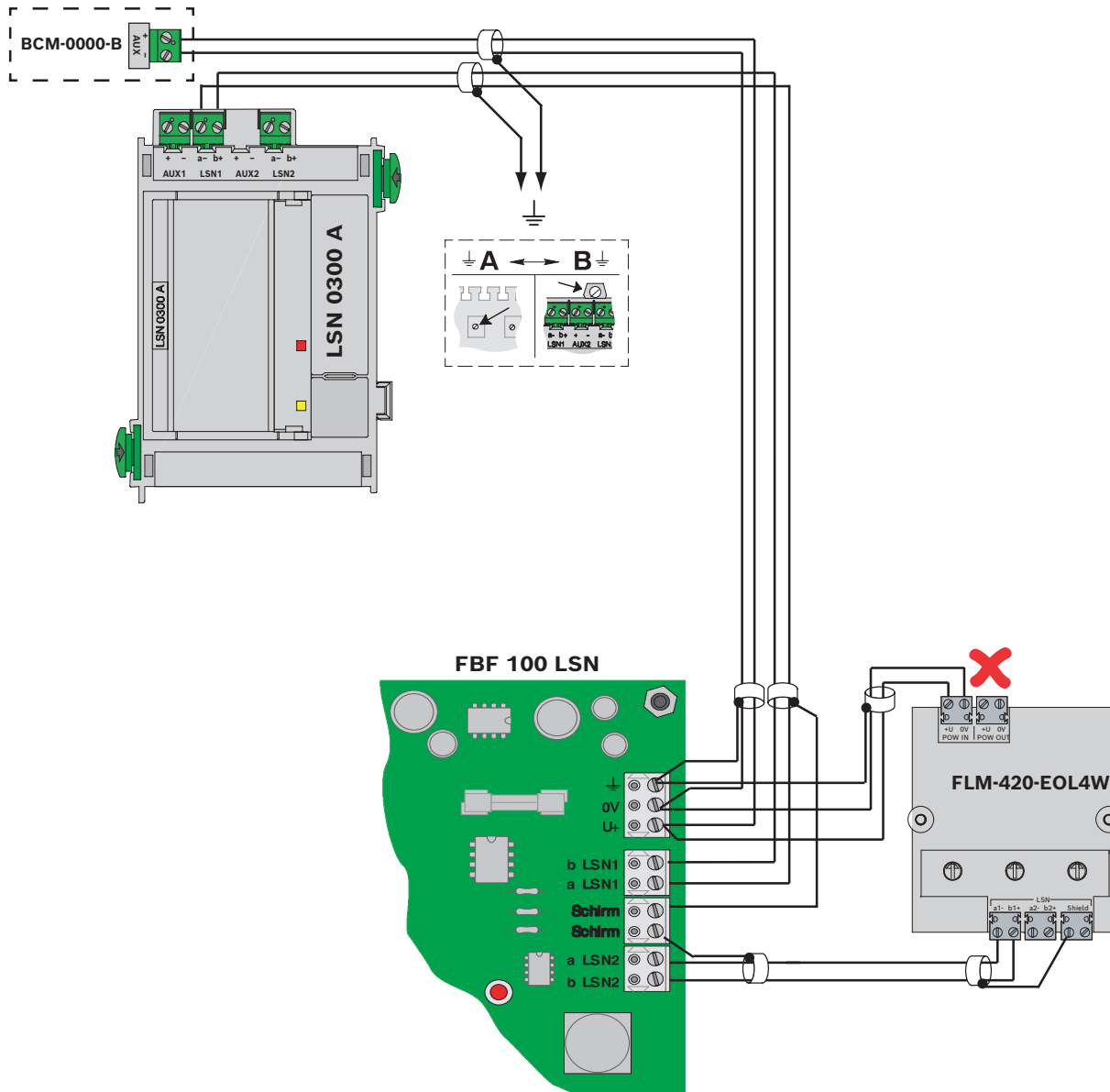



FBF 100 LSN

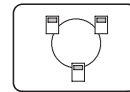

ELS

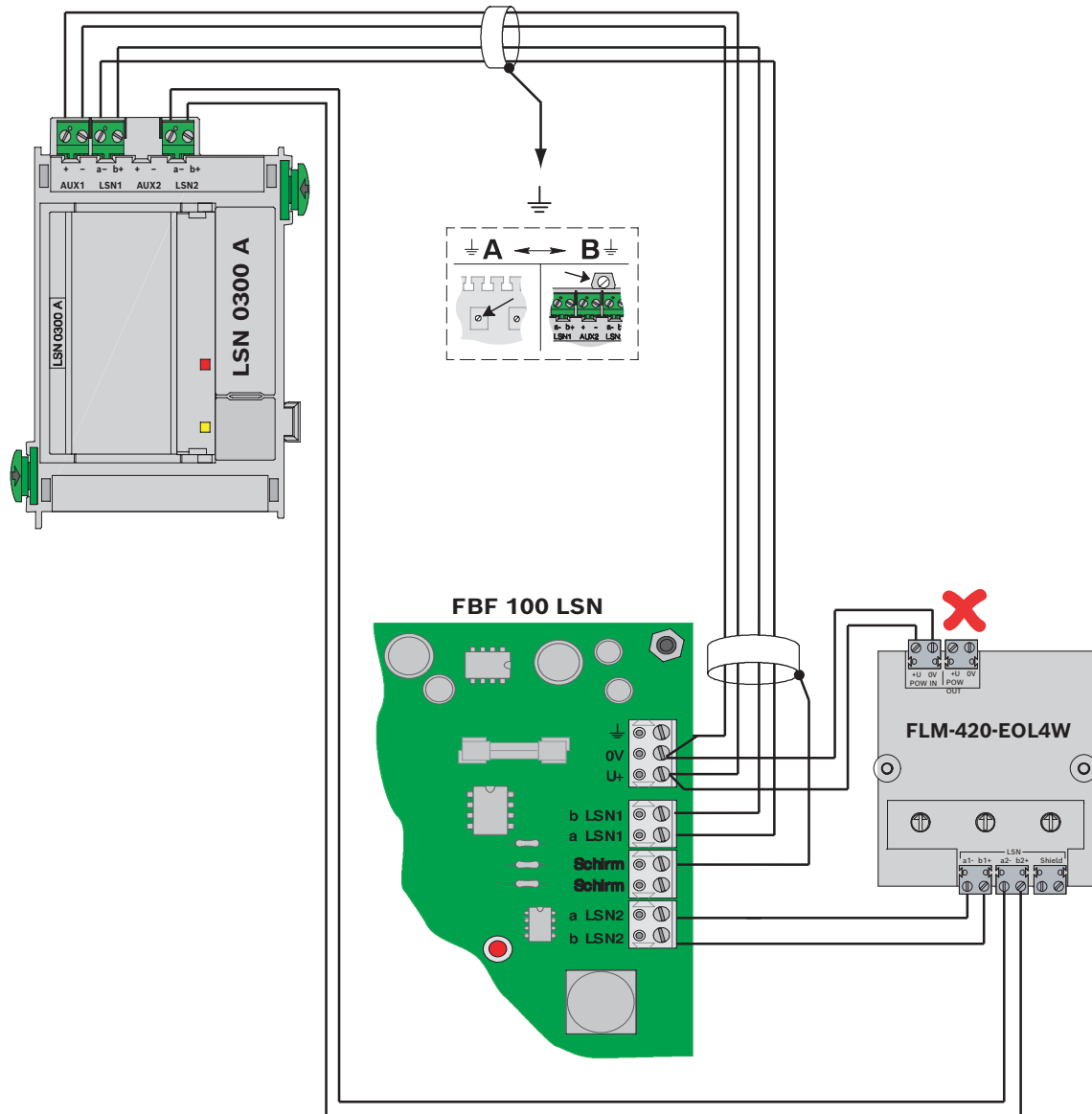

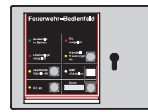

FBF 100 LSN

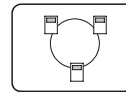

ELS

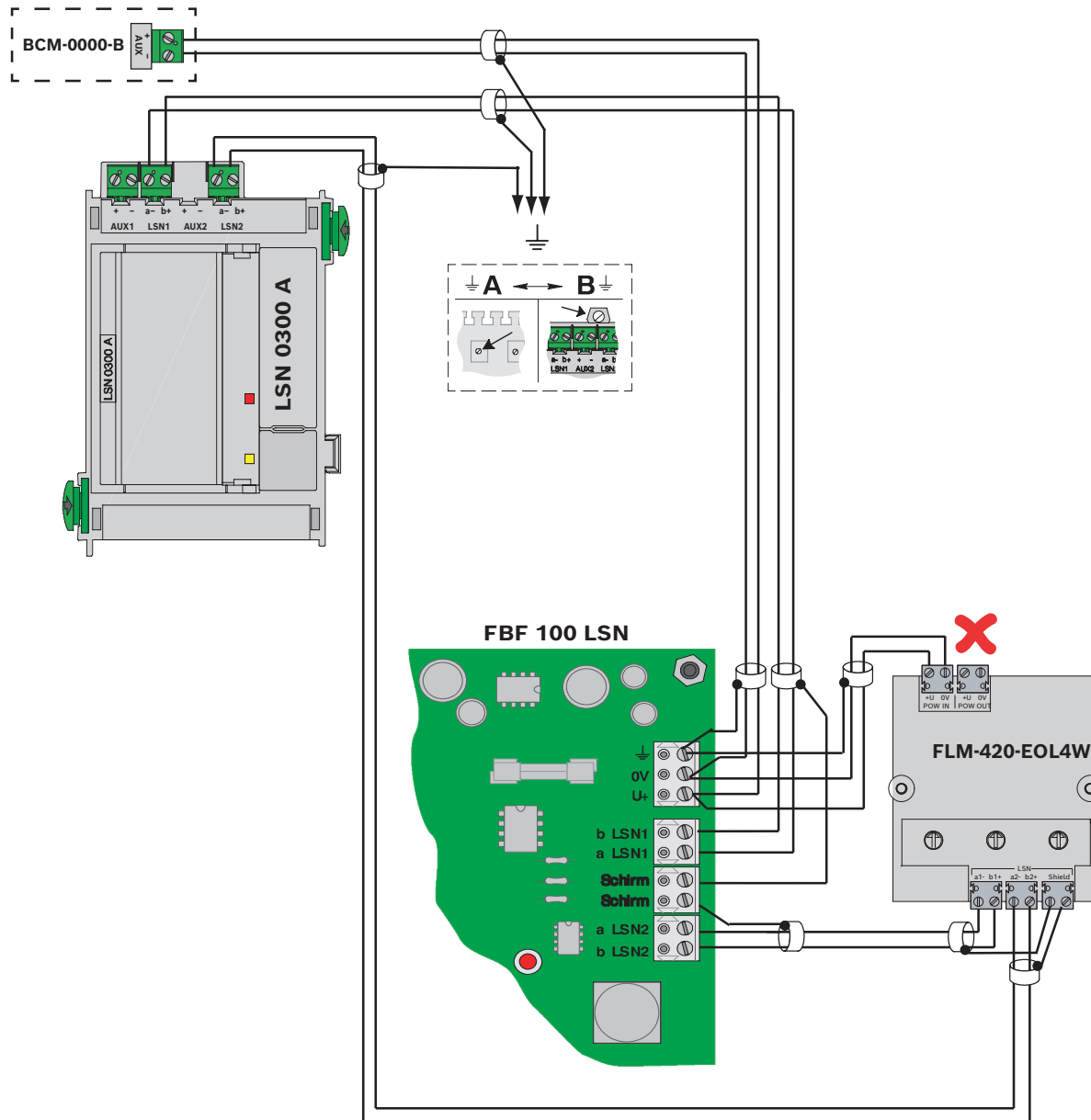

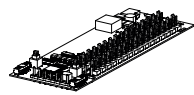

ATB 420 LSNi

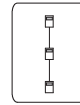

ELS

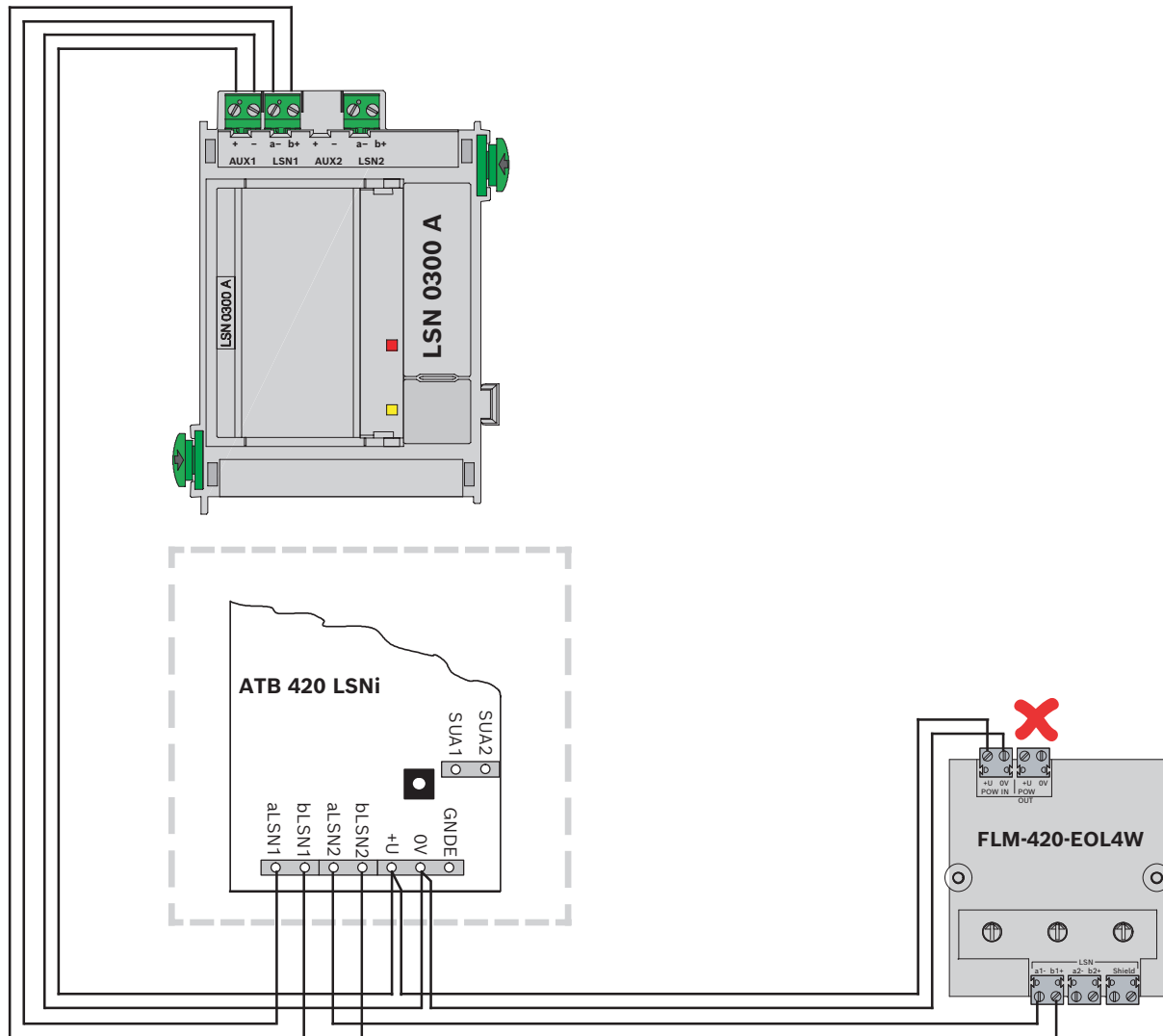

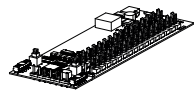

ATB 420 LSNi

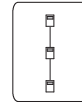

ELS

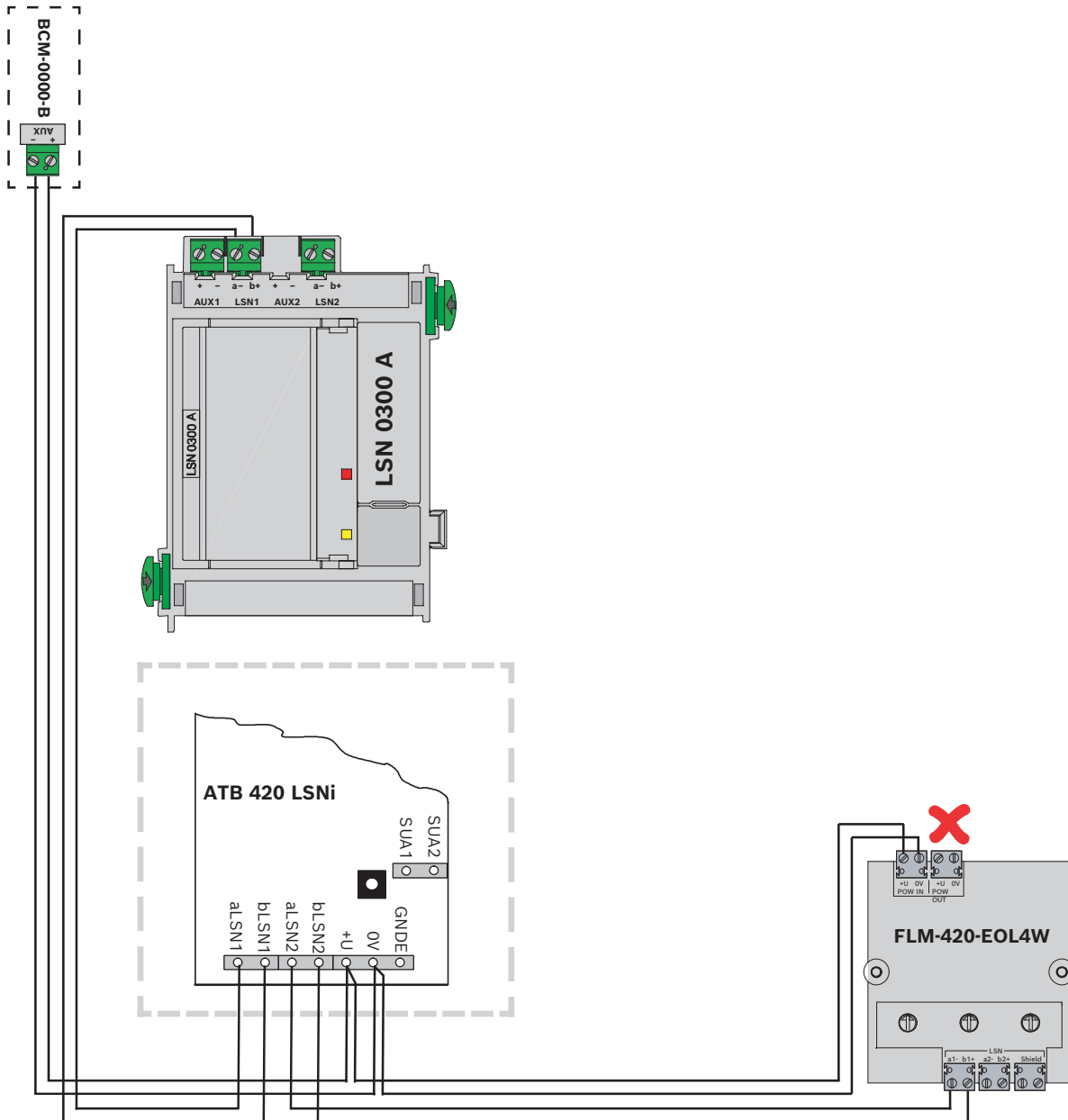

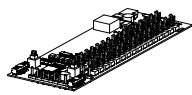

ATB 420 LSNi

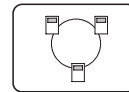

ELS

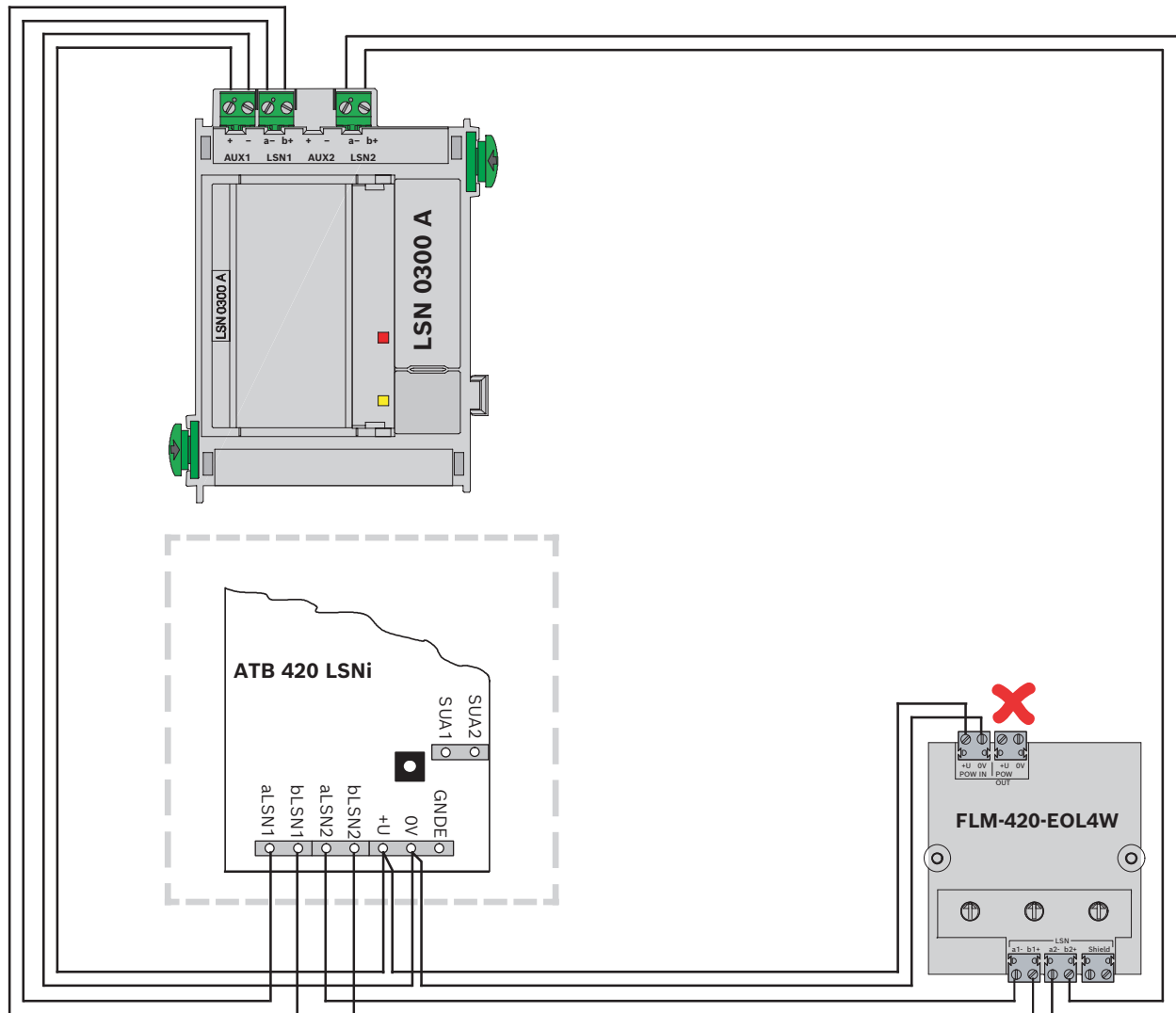

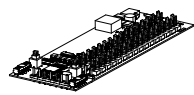

ATB 420 LSNi

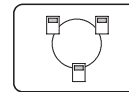

ELS

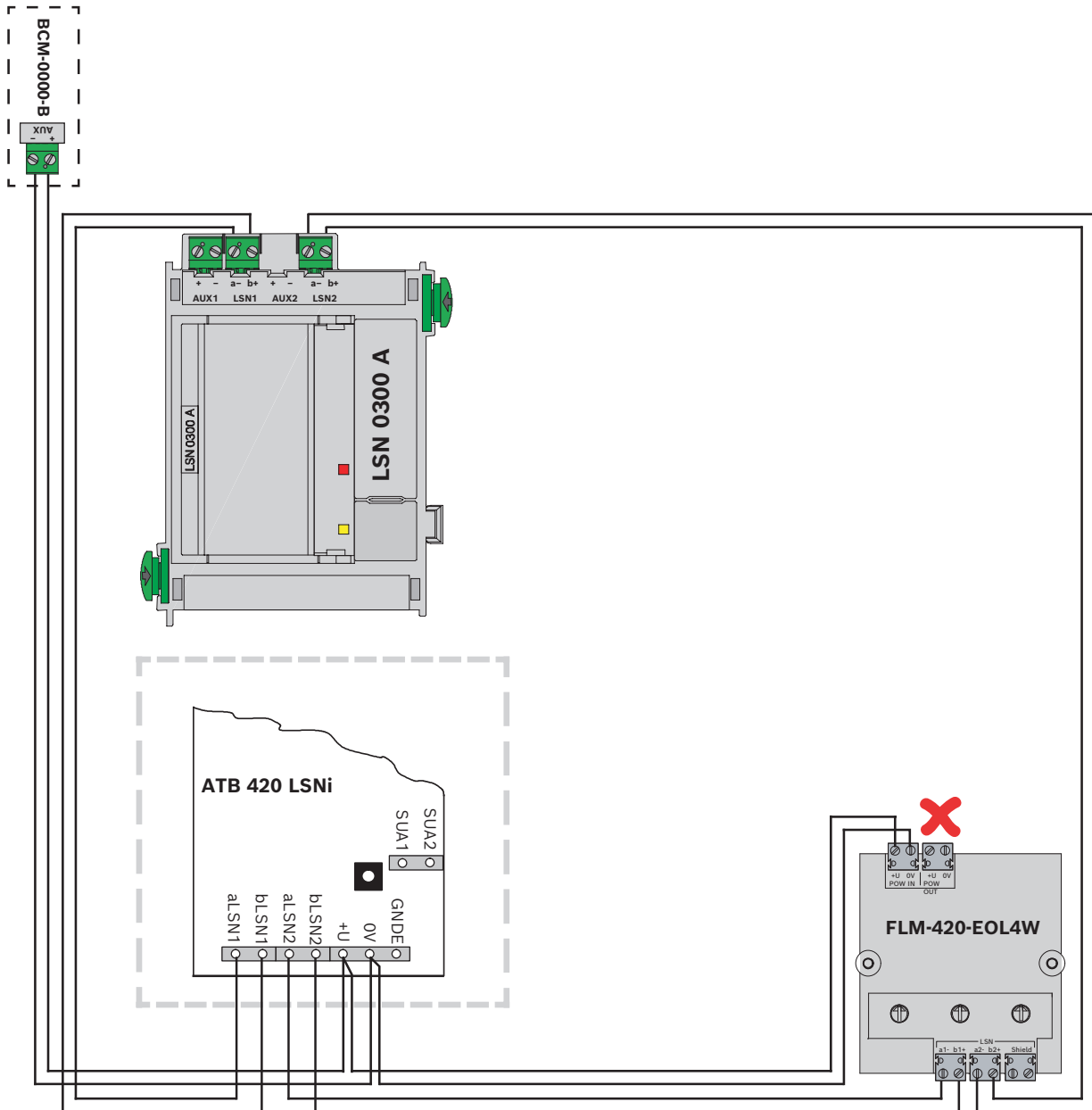



**BAT 100 LSN
ATG 420 LSNi**

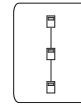

ELS

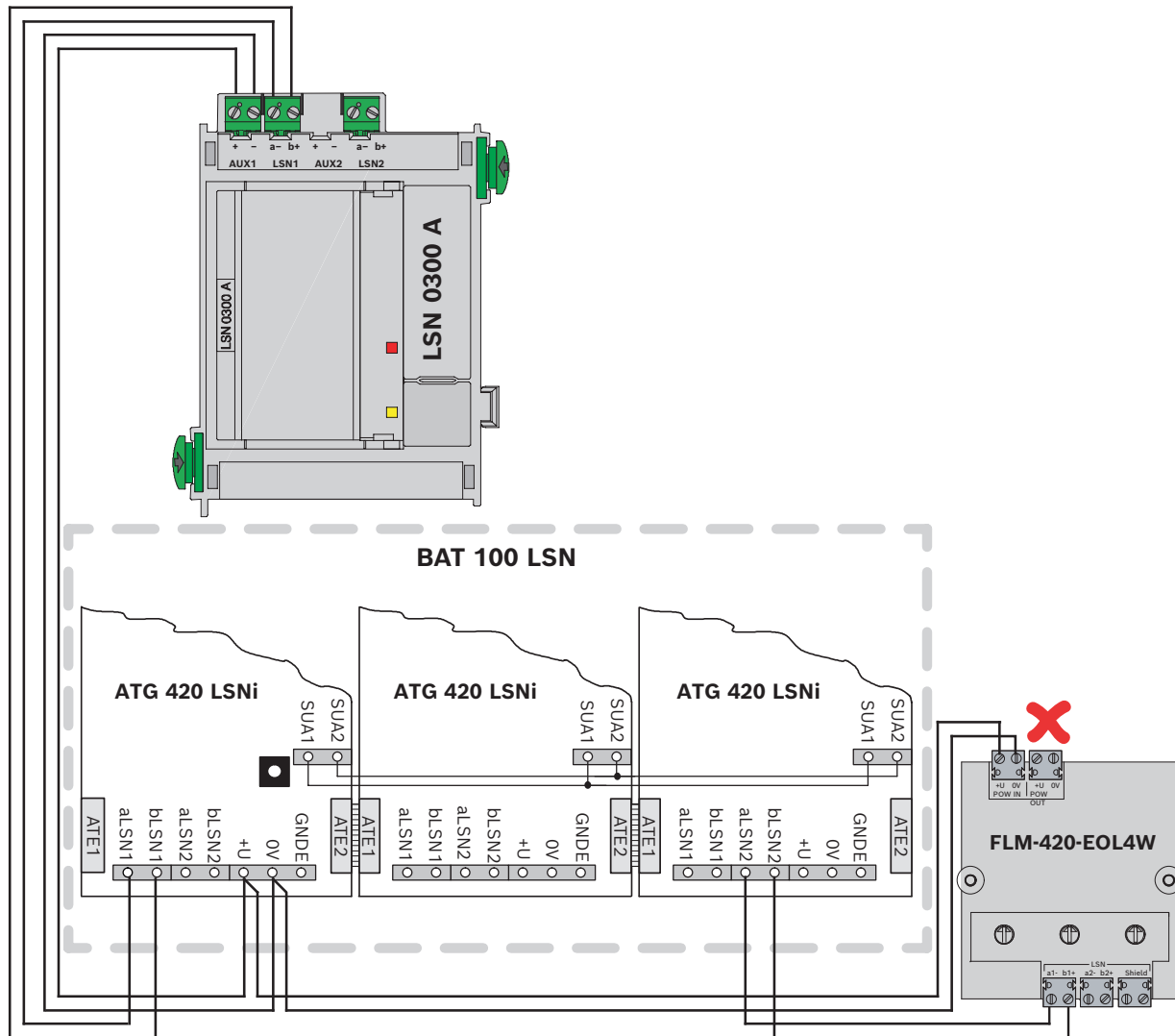



BAT 100 LSN
ATG 420 LSNi

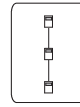

ELS

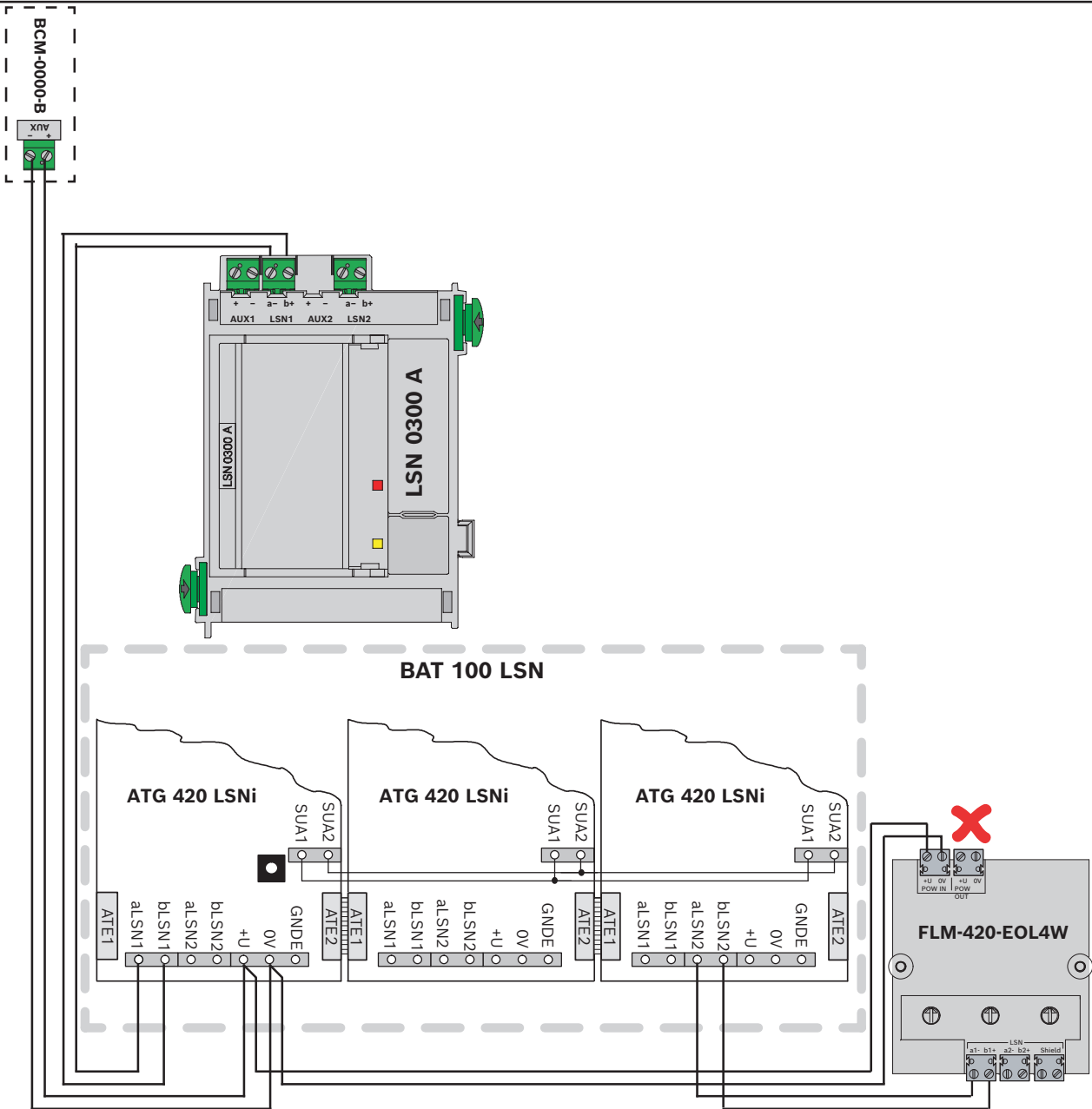



**BAT 100 LSN
ATG 420 LSNi**

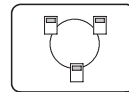

ELS

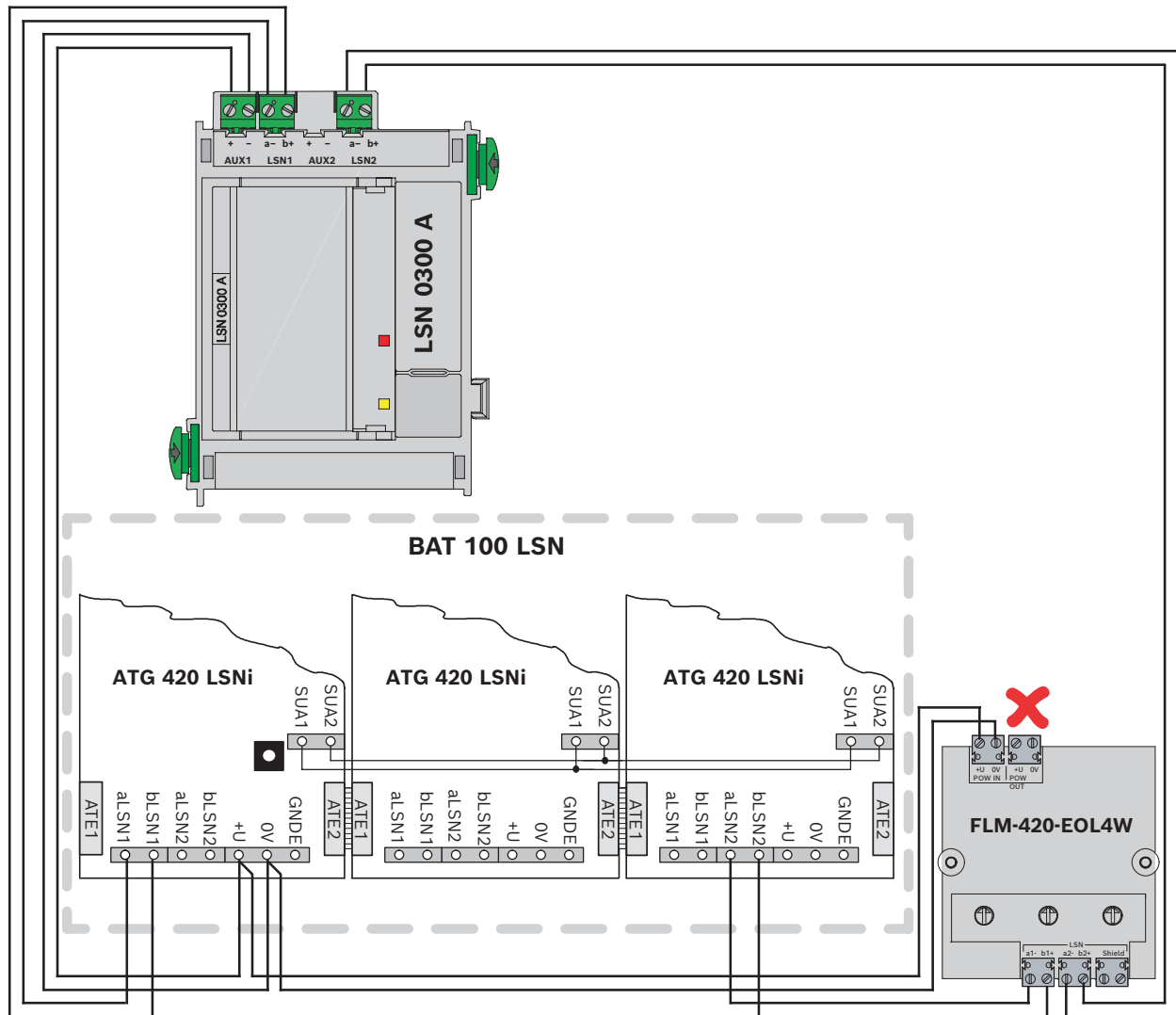



BAT 100 LSN
ATG 420 LSNi

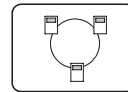

ELS

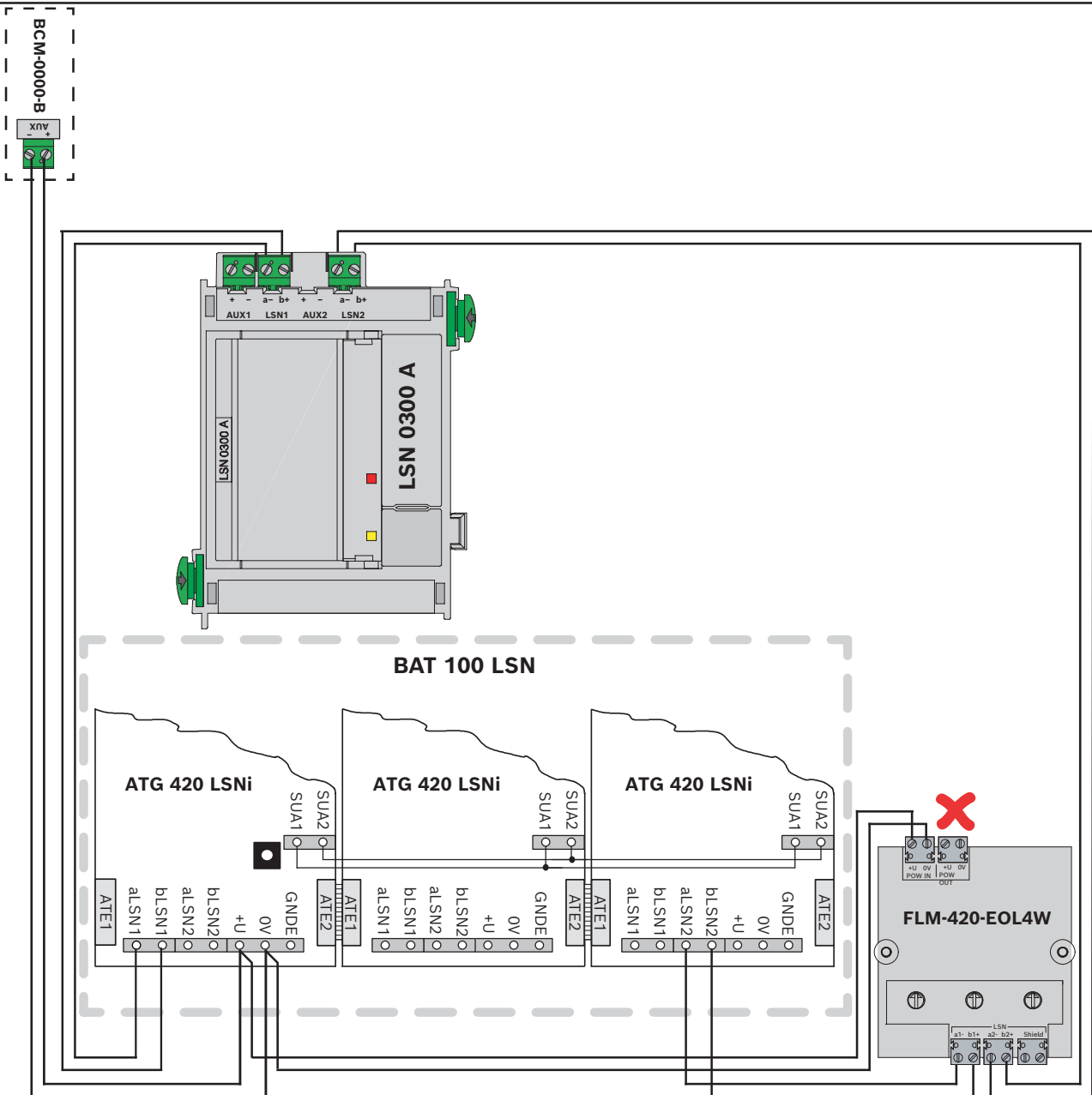



FNX-425U-WFWH
 FNX-425U-RFWH
 FNX-425U-WFRD
 FNX-425U-RFRD



ELS

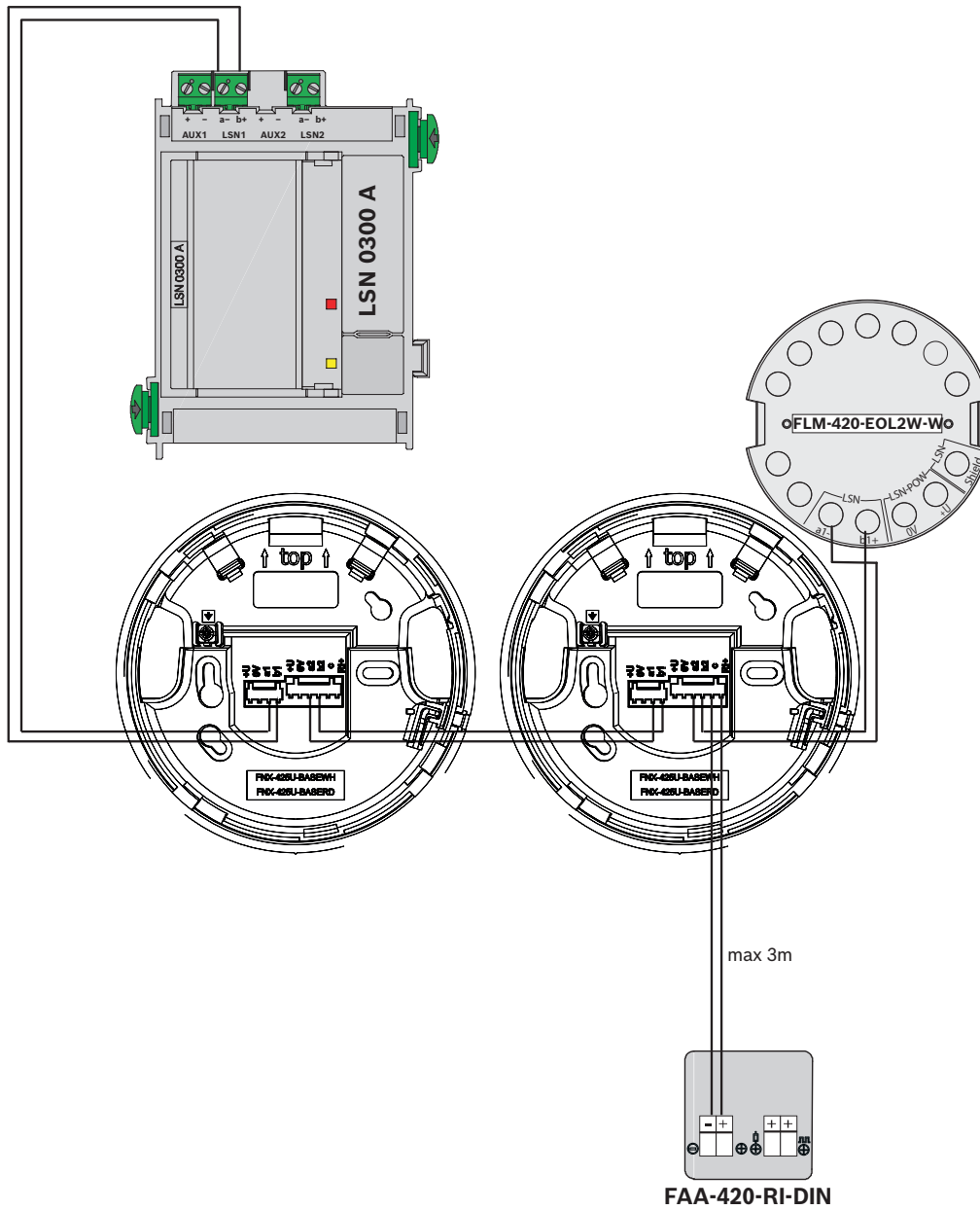



FNX-425U-WFWH
 FNX-425U-RFWH
 FNX-425U-WFRD
 FNX-425U-RFRD

+ FNX-425U-COVWH
 FNX-425U-COVRD



ELS

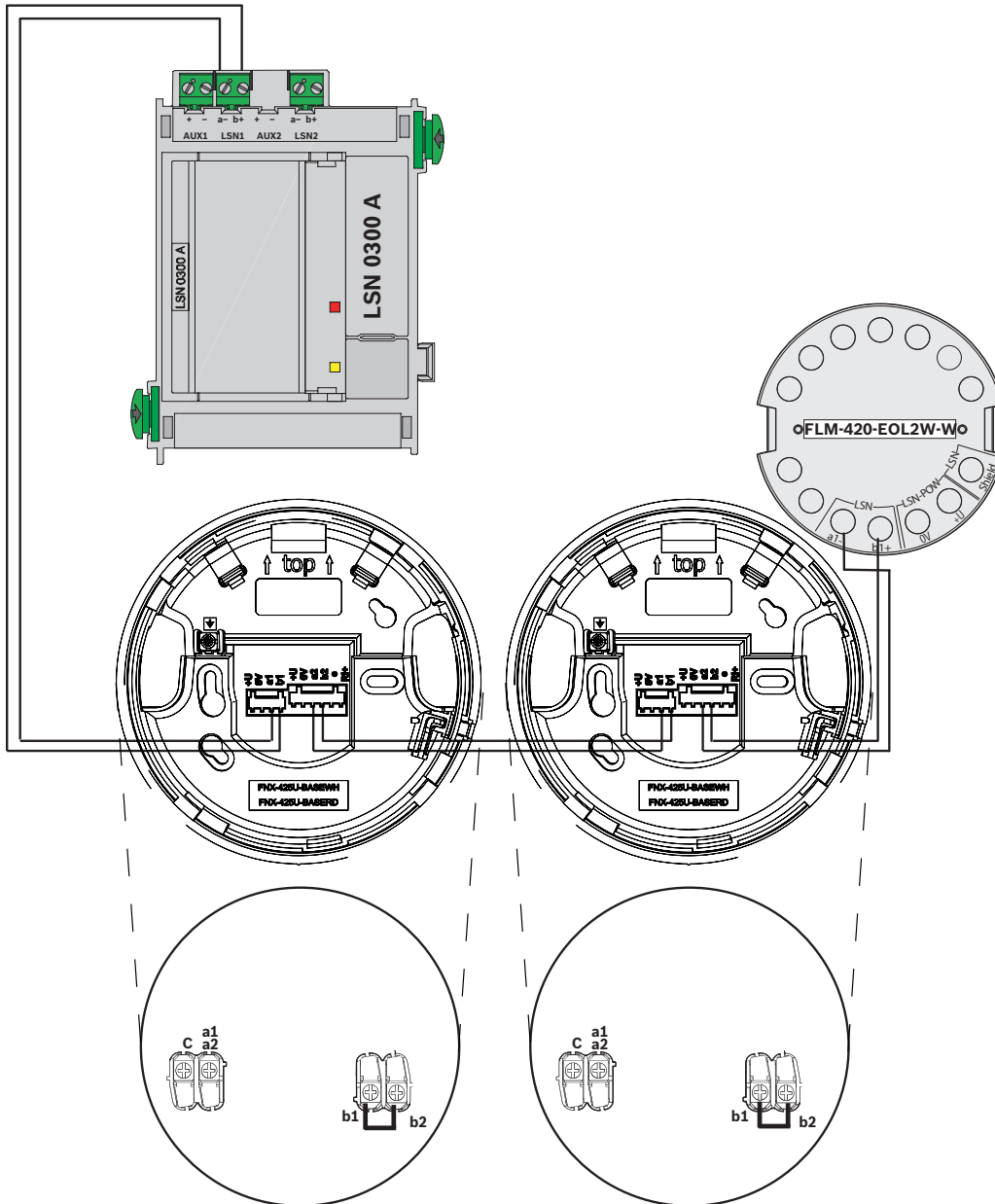

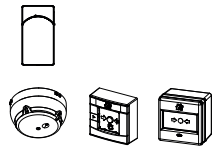

FWI-270

FDOOT271-O
FDM275-O
FDM273-O

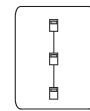

ELS

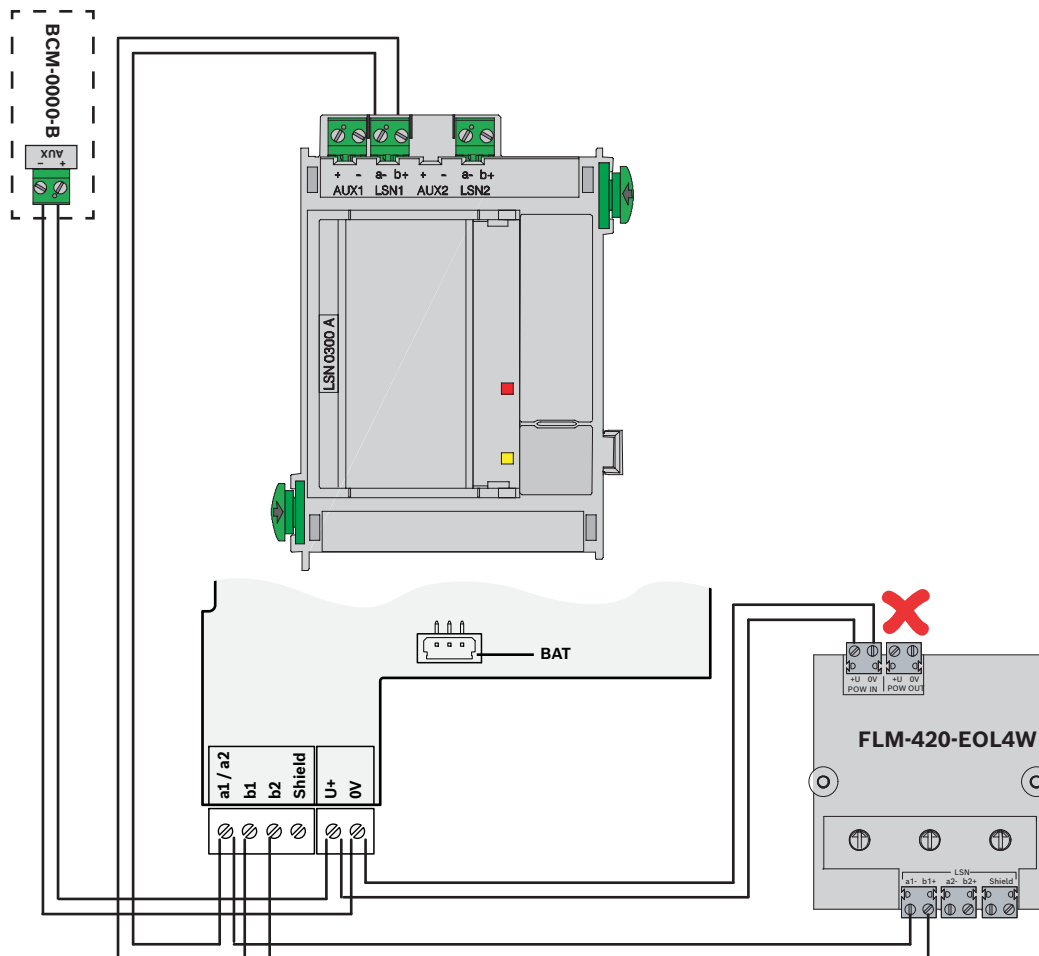

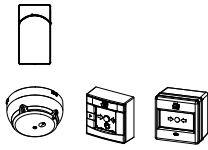

FWI-270

FDOOT271-O
FDM275-O
FDM273-O

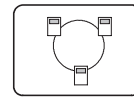

ELS

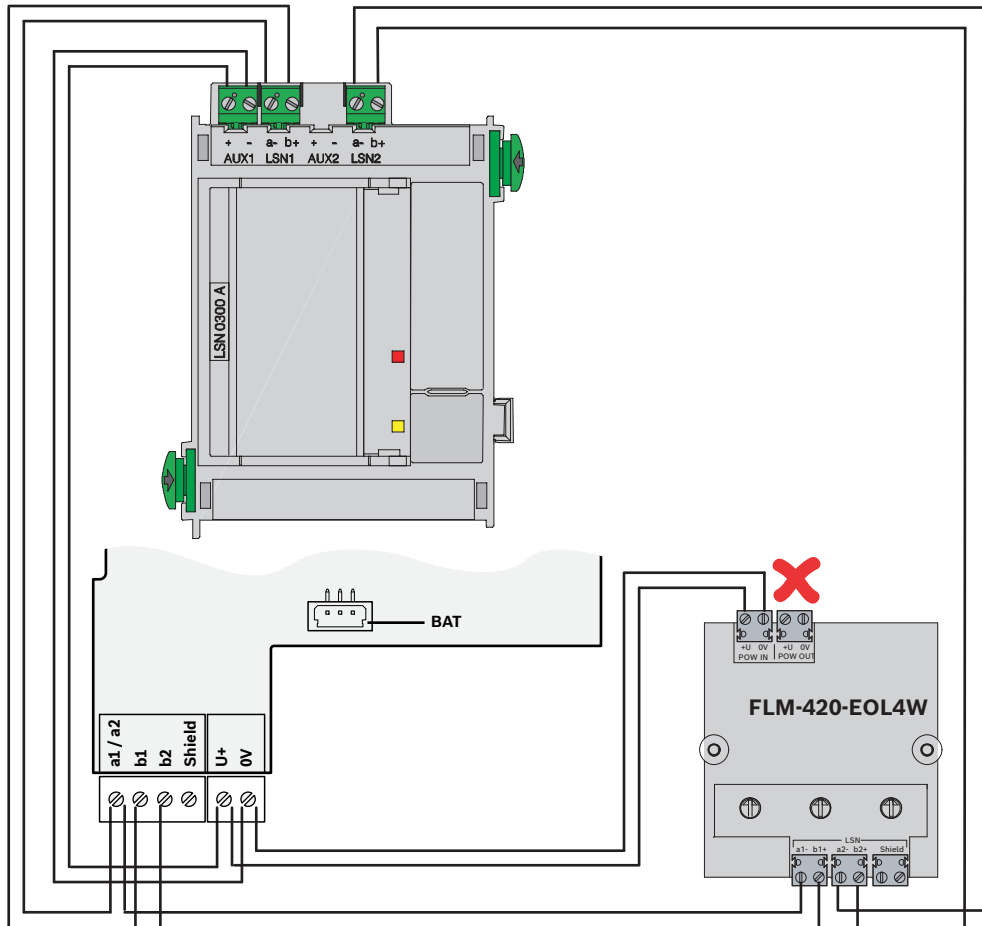

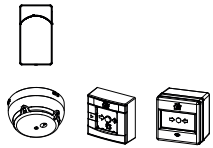

FWI-270

FDOOT271-O
FDM275-O
FDM273-O

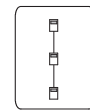

ELS

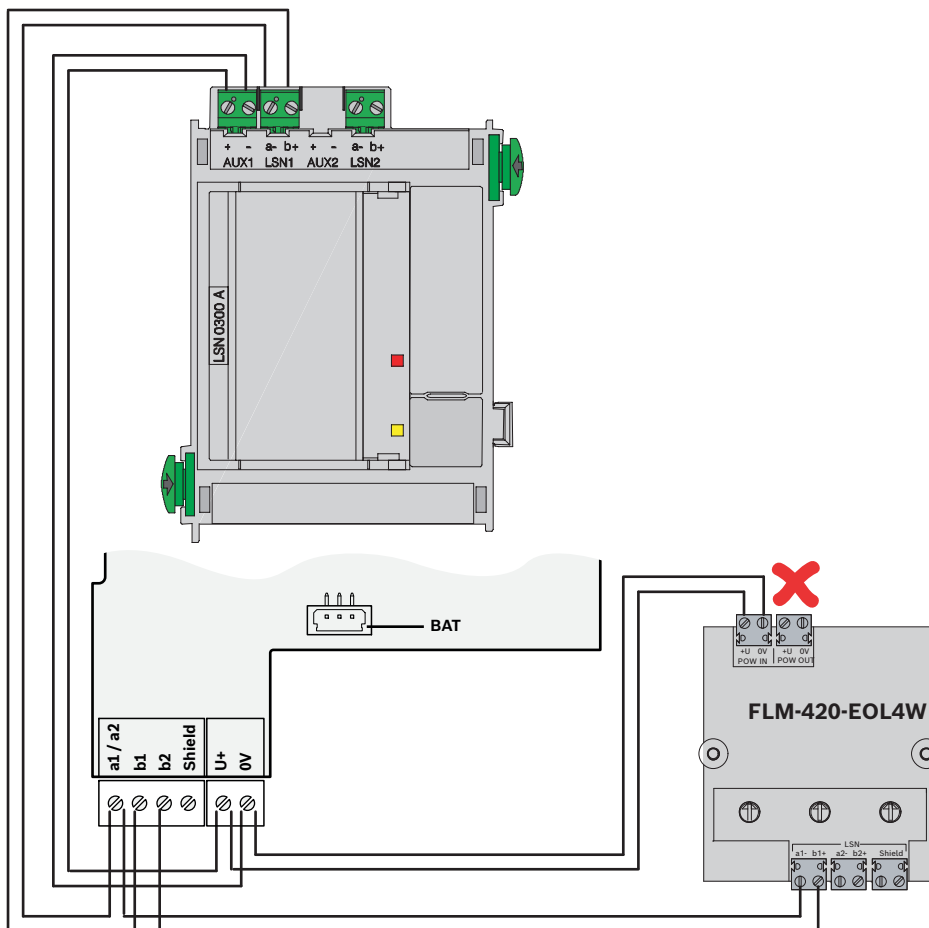

2.6.3 FLM-420/4-CON-S/D

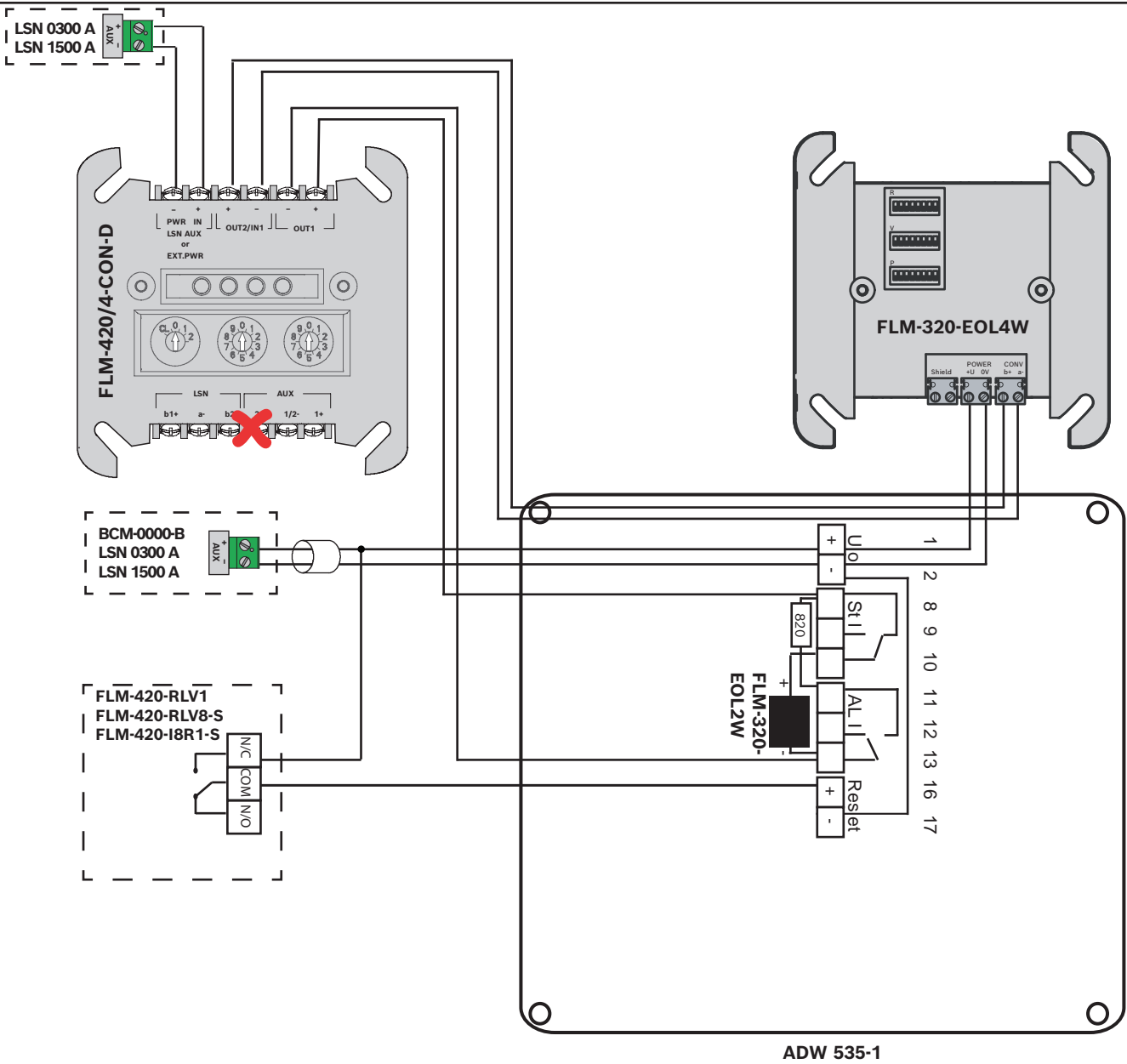
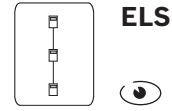

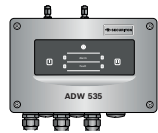

ADW 535-2

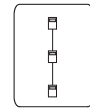

ELS

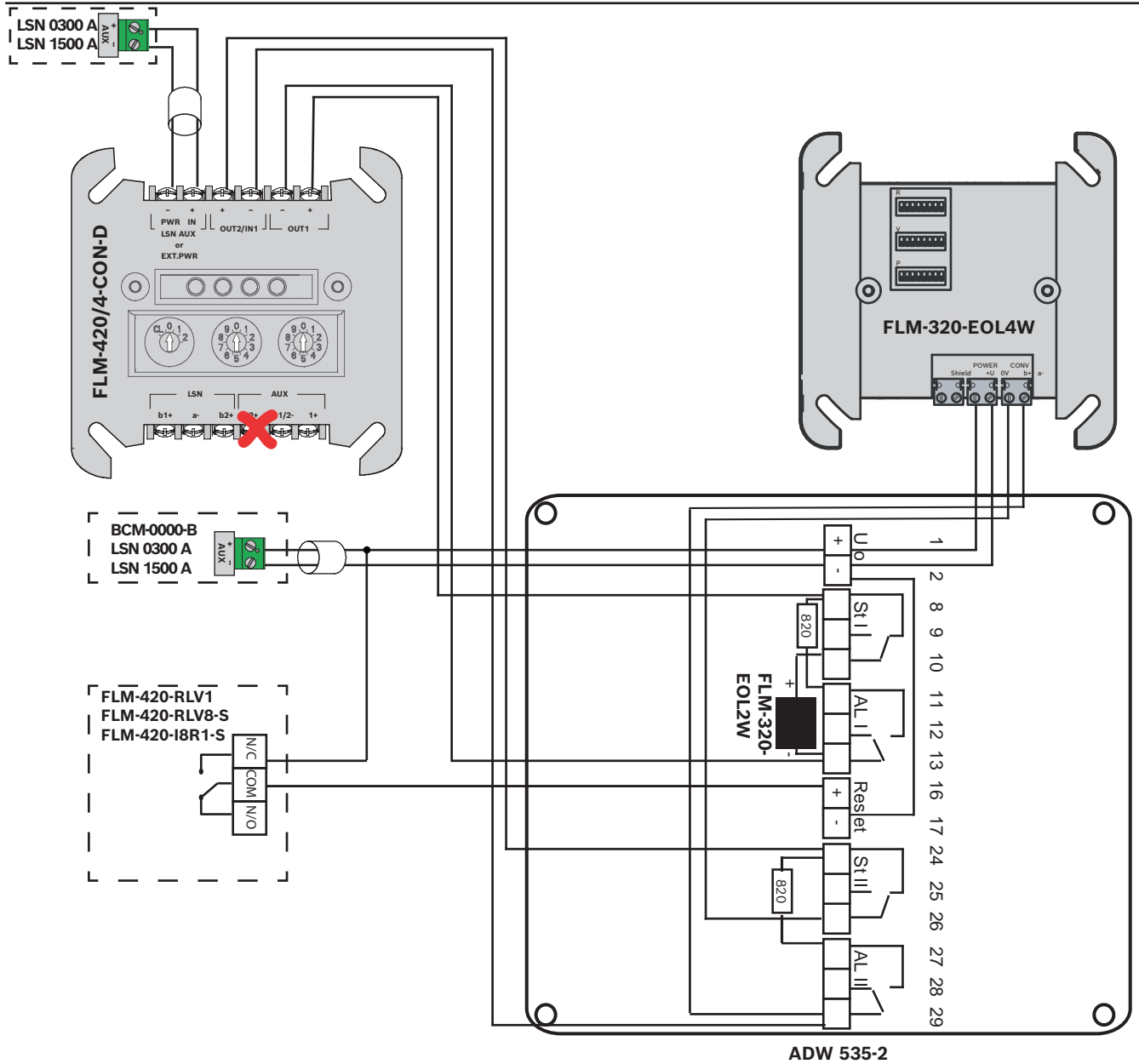

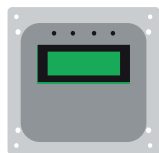

ALARMLINE II



ELS

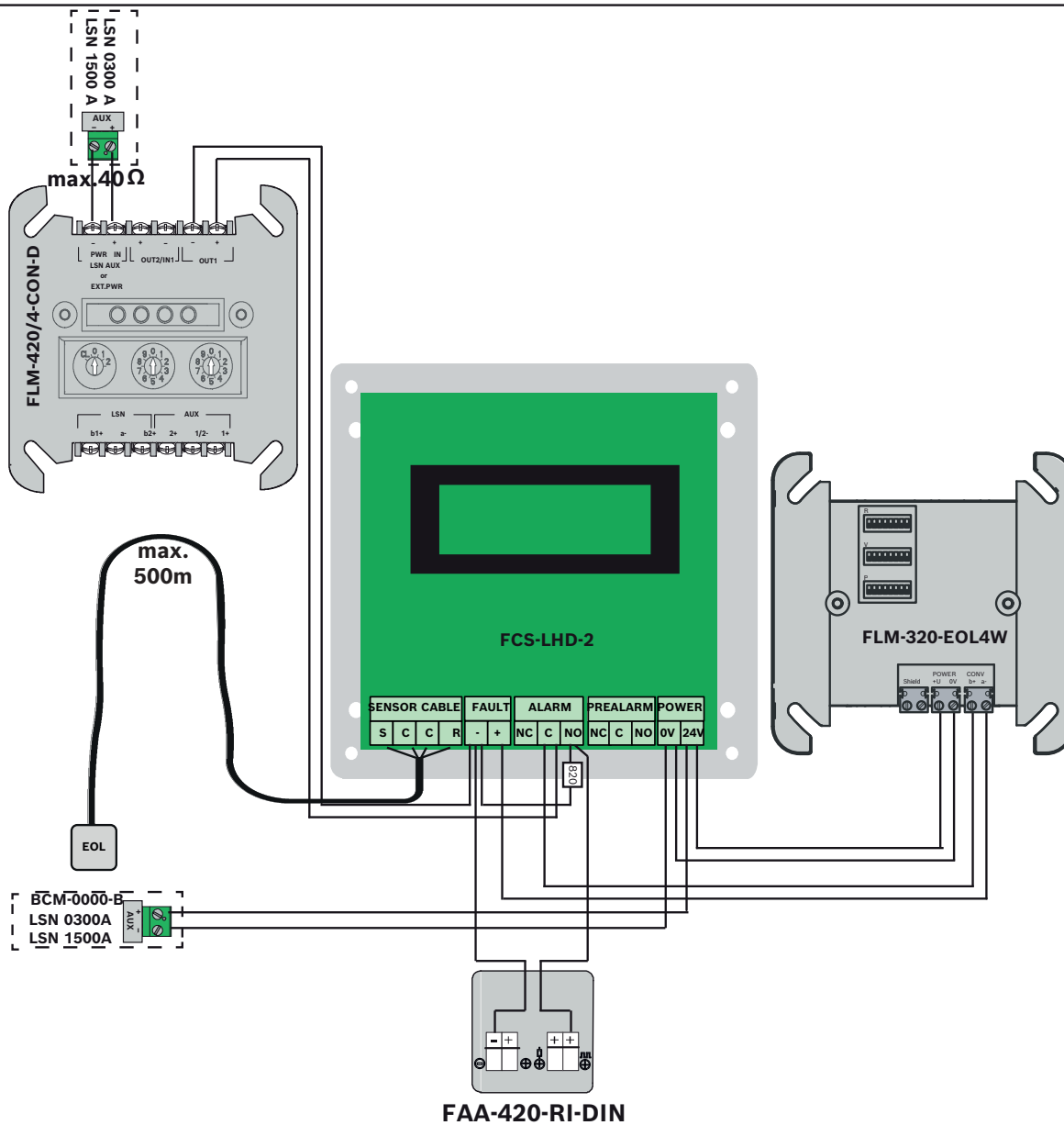



thefirebeam nano
thefirebeam standard
thefirebeam foveo

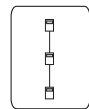

ELS

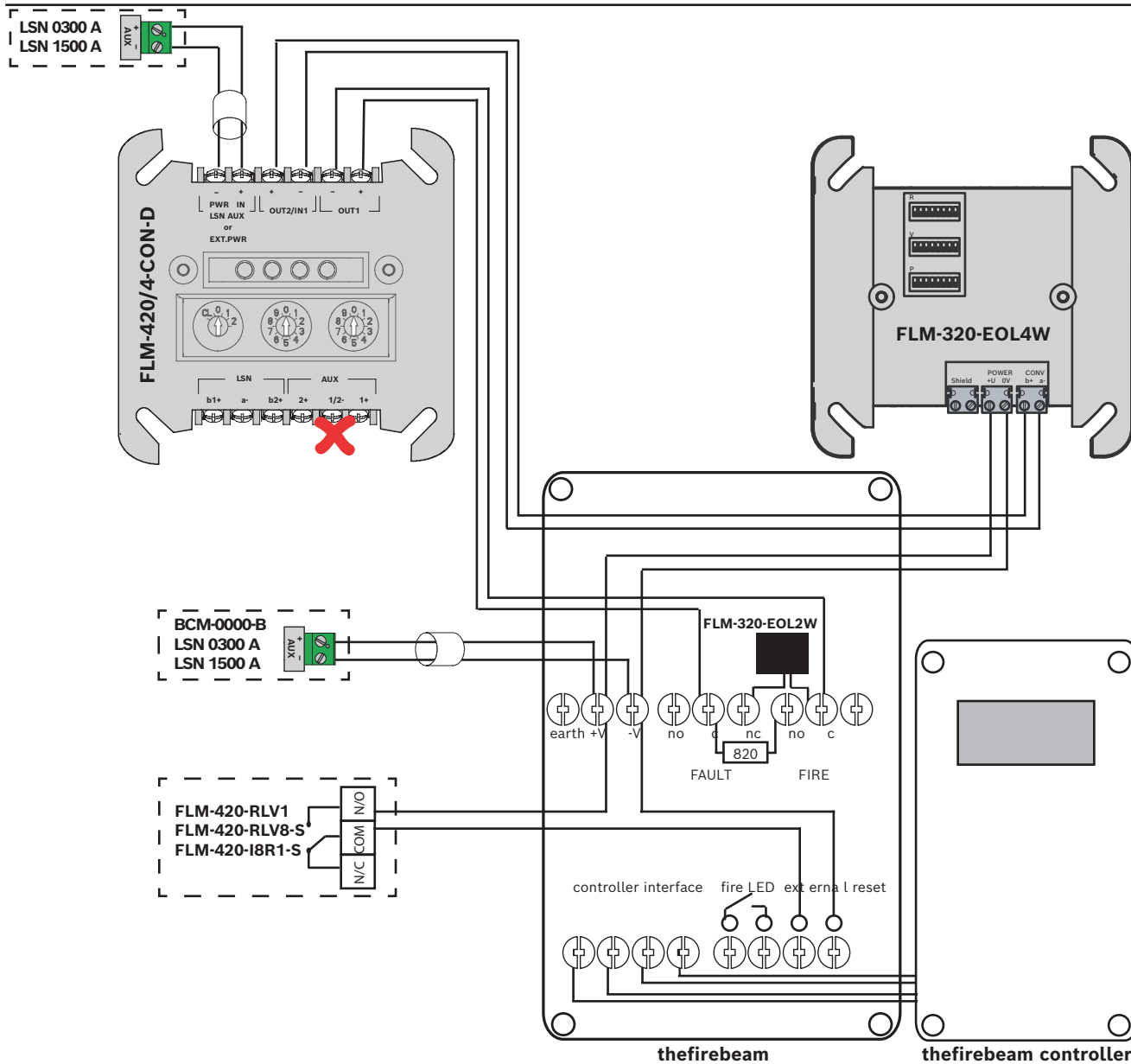

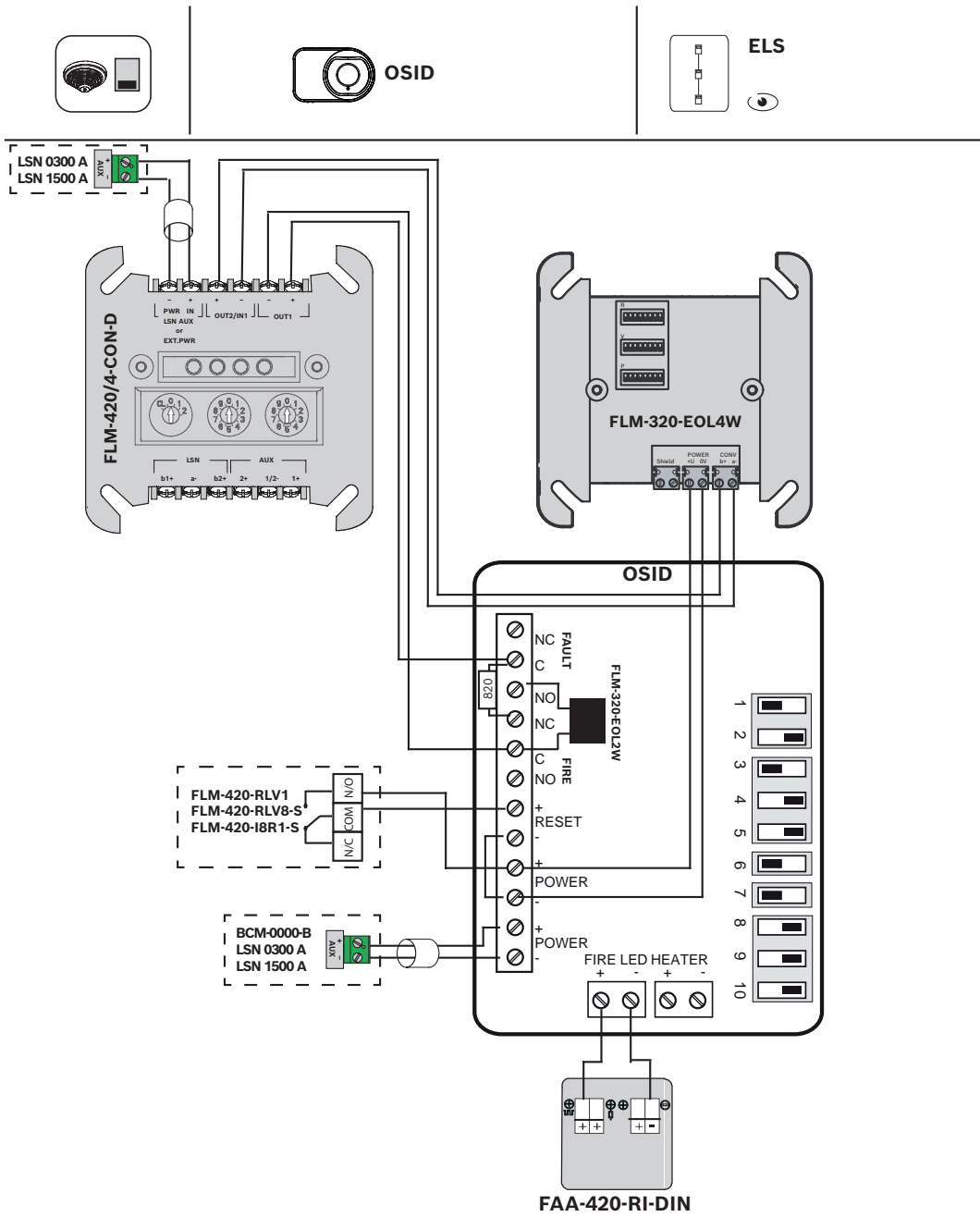

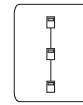

ELS

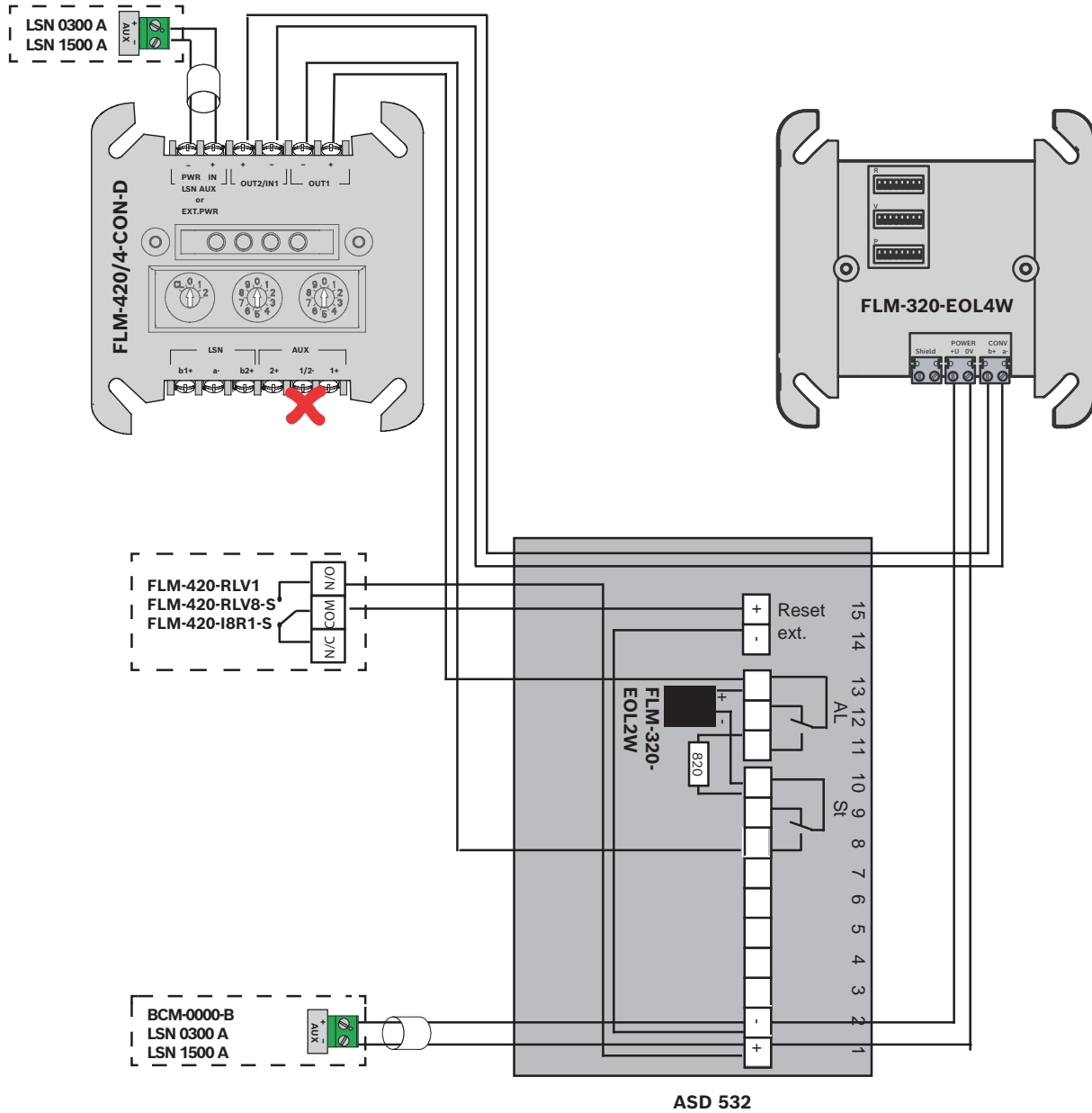

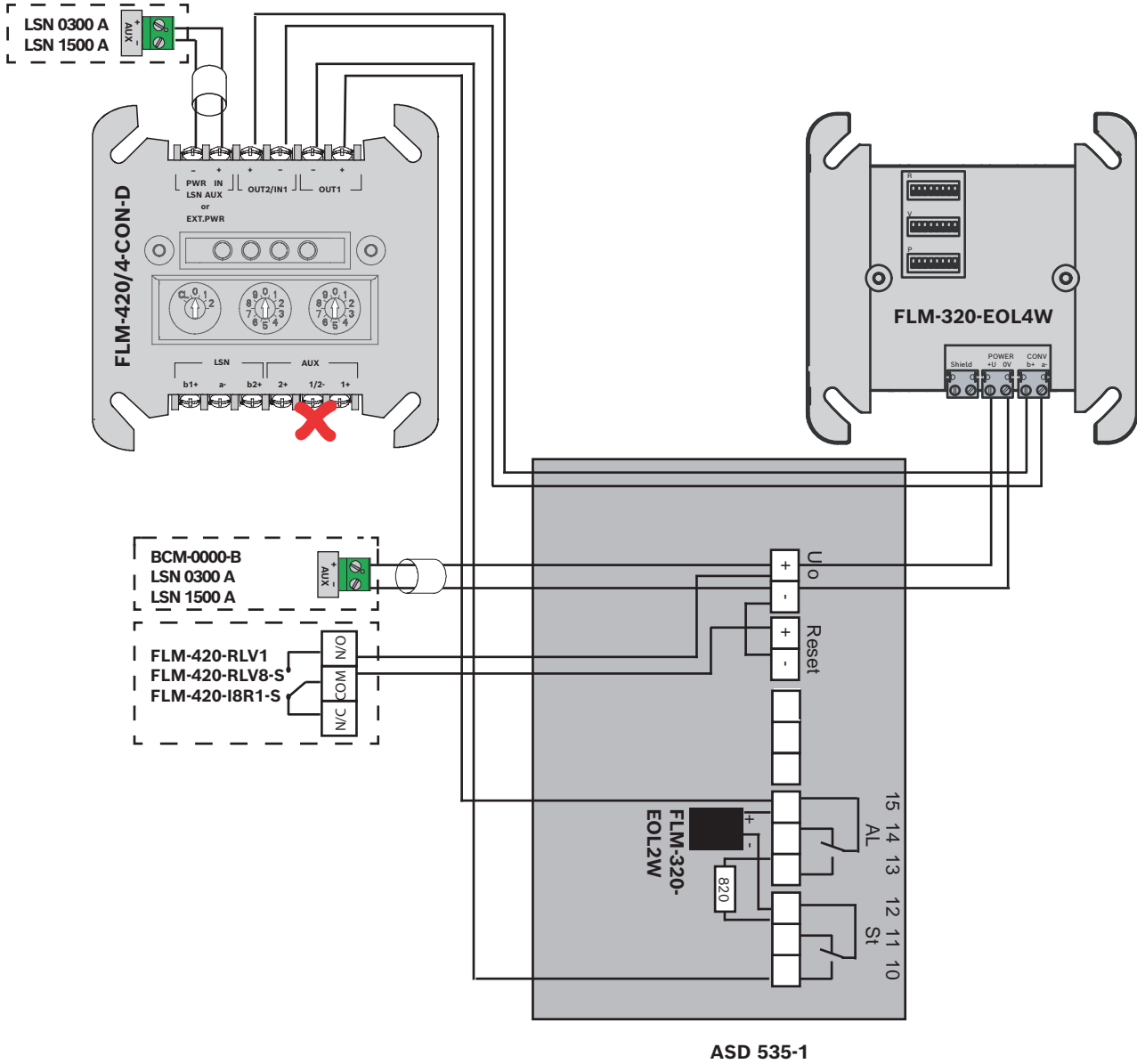
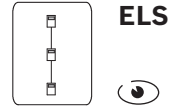

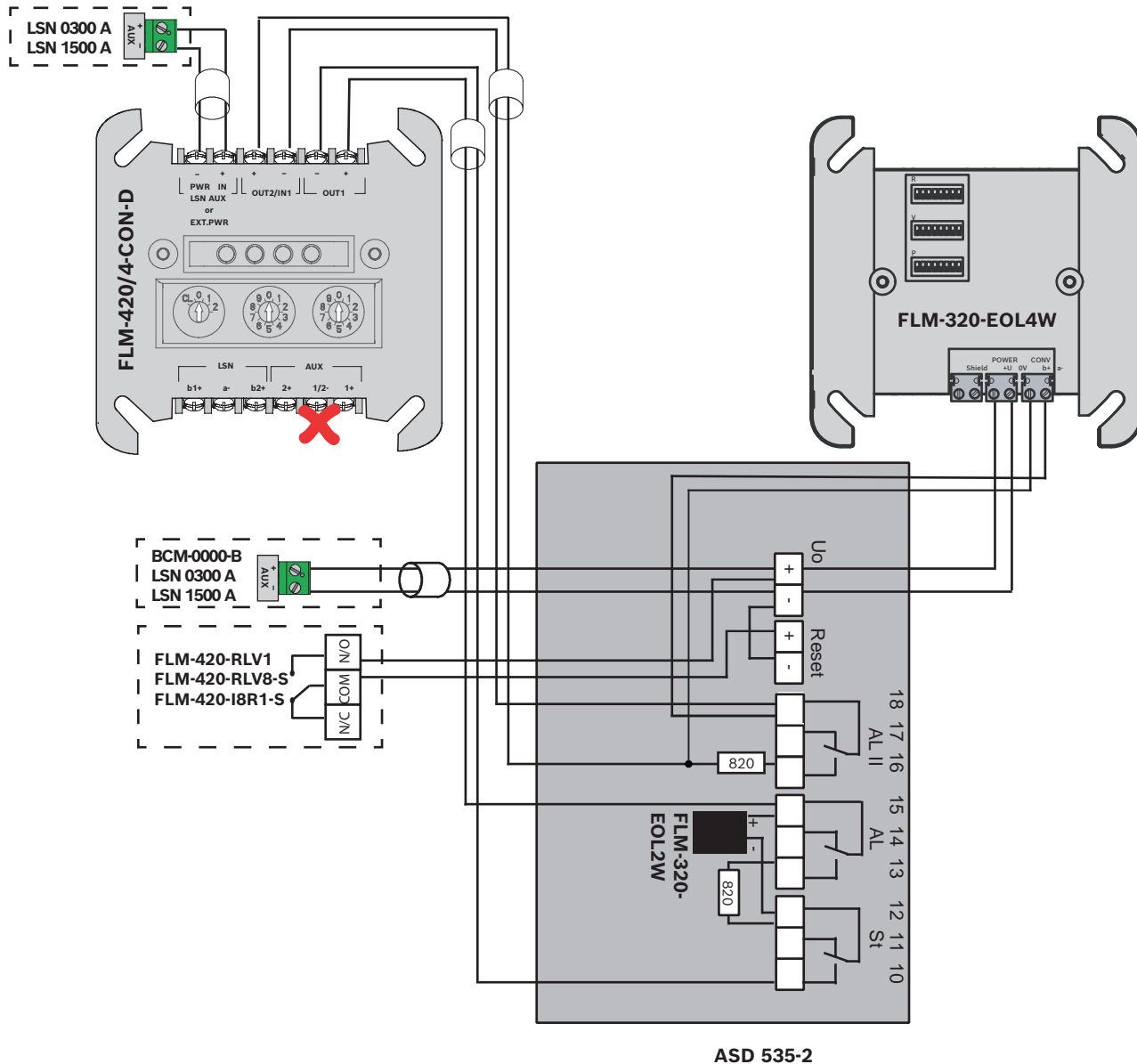
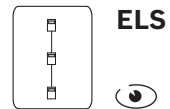

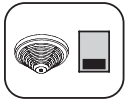

FCS-LWM-1

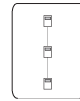

ELS

BCM-0000-B
LSN 0300 A
LSN 1500 A

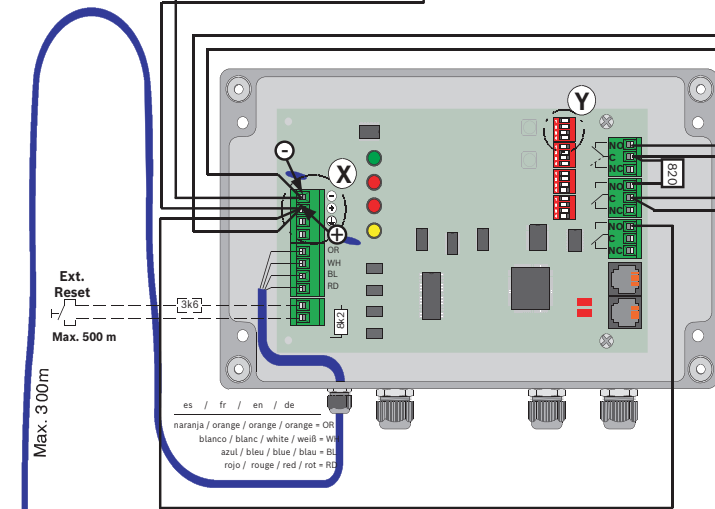
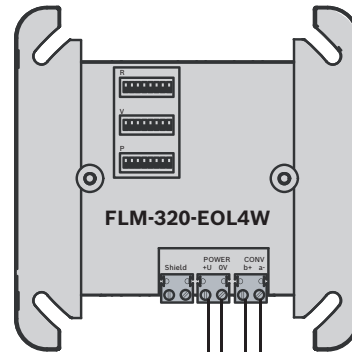
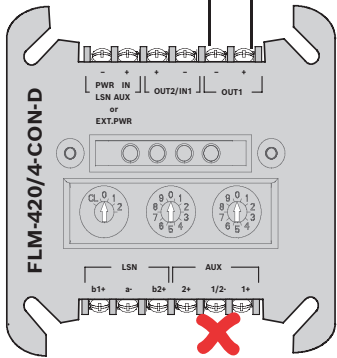

es / fr / en / de
naranja / orange / orange / orange = OR
blanco / blanc / white / weiß = WH
azul / bleu / blue / blau = BL
rojo / rouge / red / rot = RE



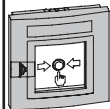
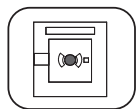

FMC-120-DKM-G-R FMC-120-DKM-G-Y
 FMC-120-DKM-H-R FMC-120-EST-G-B
 FMC-120-DKM-G-B
 FMC-120-DKM-H-B

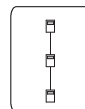

ELS

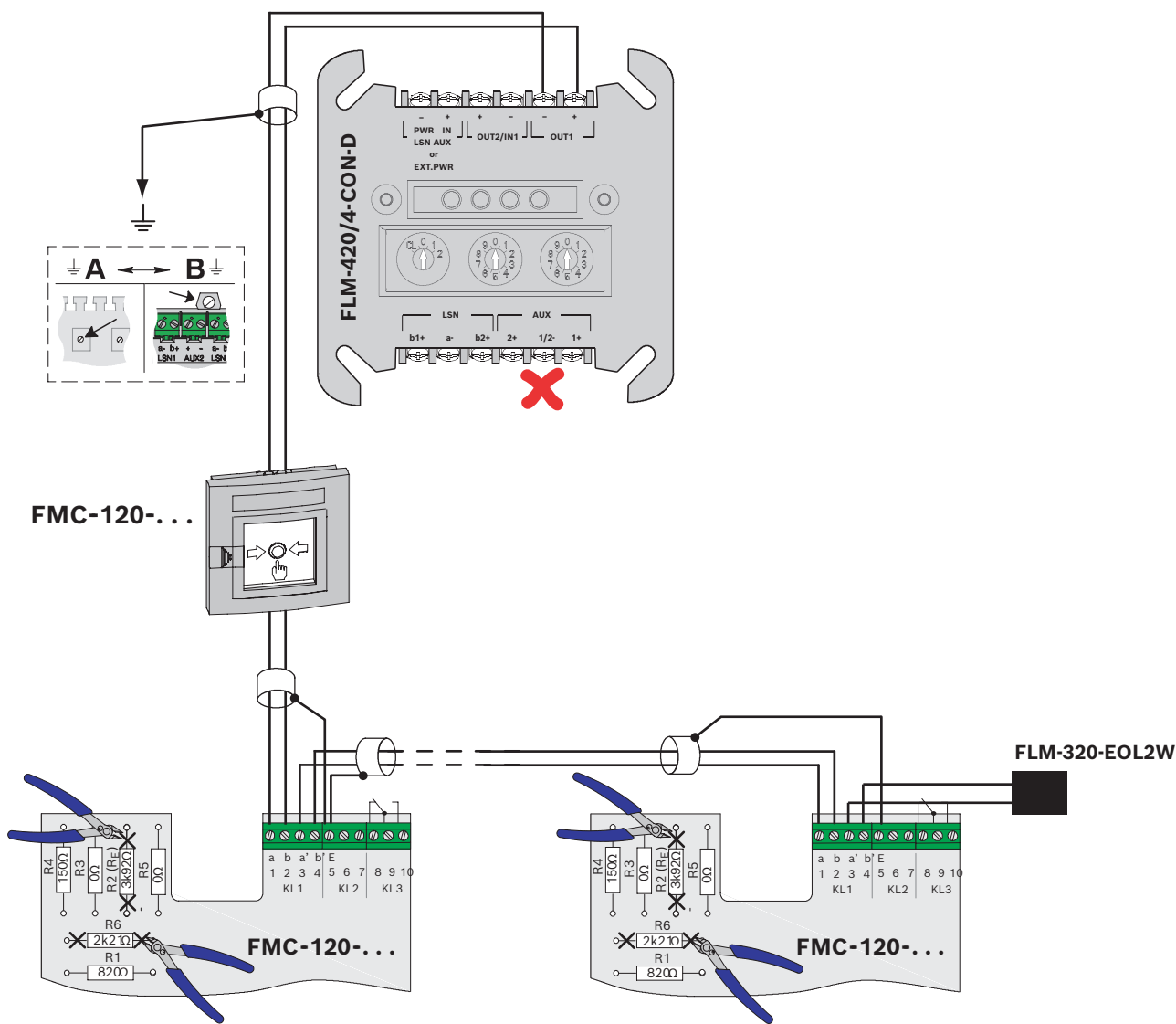



FMC-300

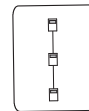

ELS

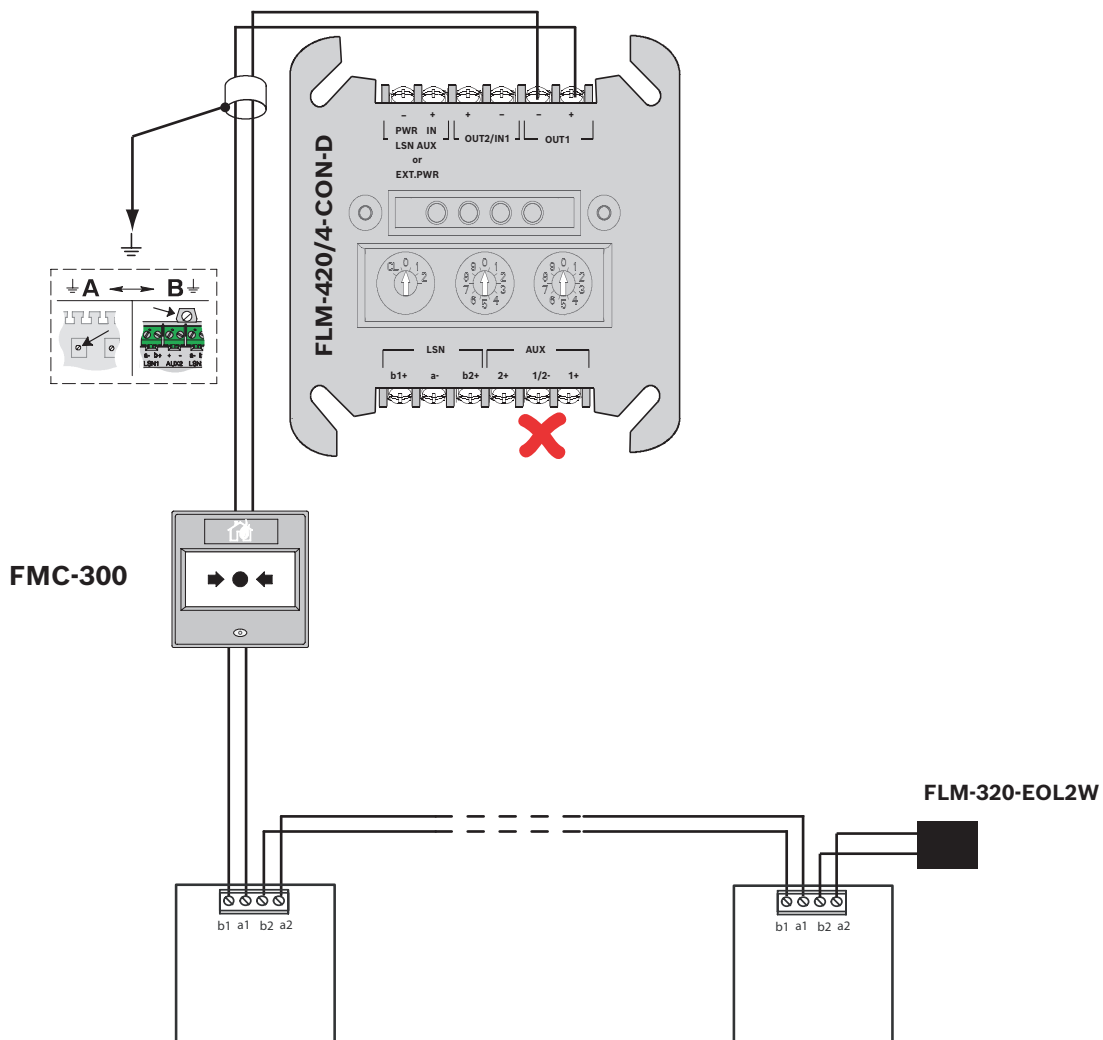

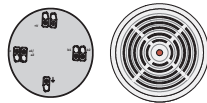

MSS 400, MSS 400 B
 FCH-320-T320
 FCH-T320-R470, FCH-T320-FSA
 FCP-O320, FCP-O320-R470
 FCP-OC320, FCP-OC320-R470
 FCP-OT320, FCP-OT320-R470



ELS

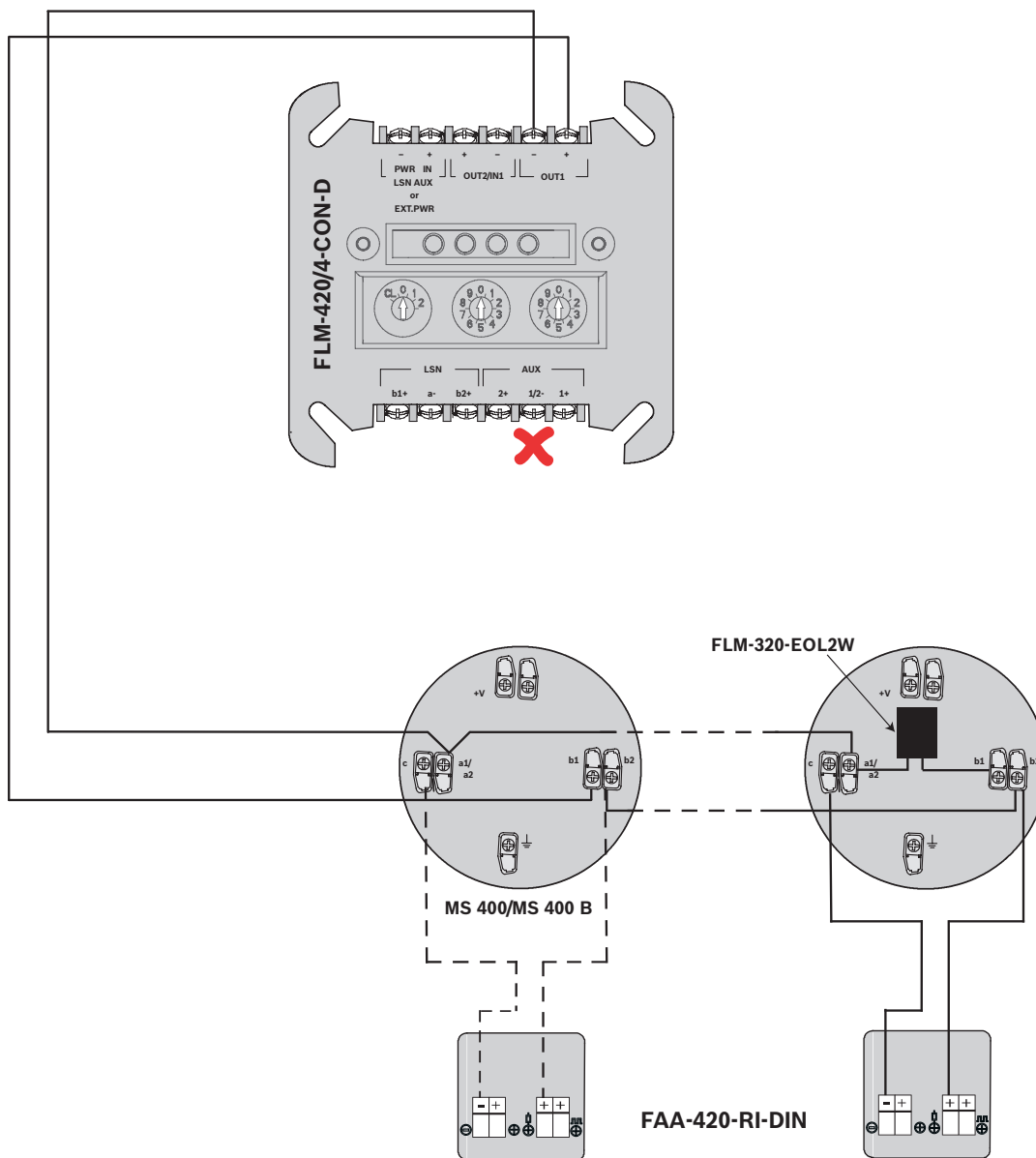



FCP-500



ELS

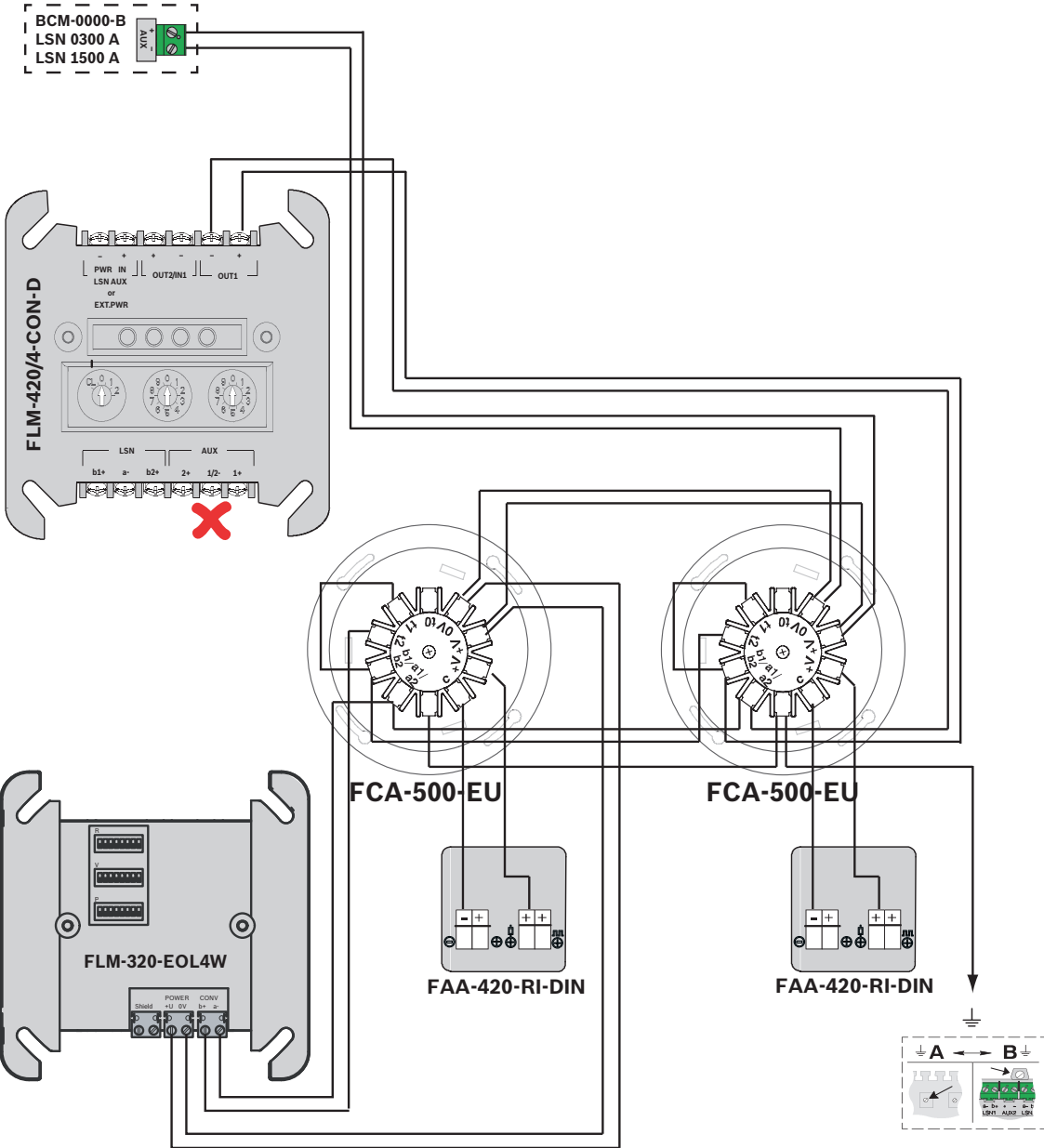

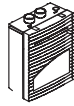

FCS-320-TM Series

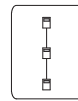

ELS

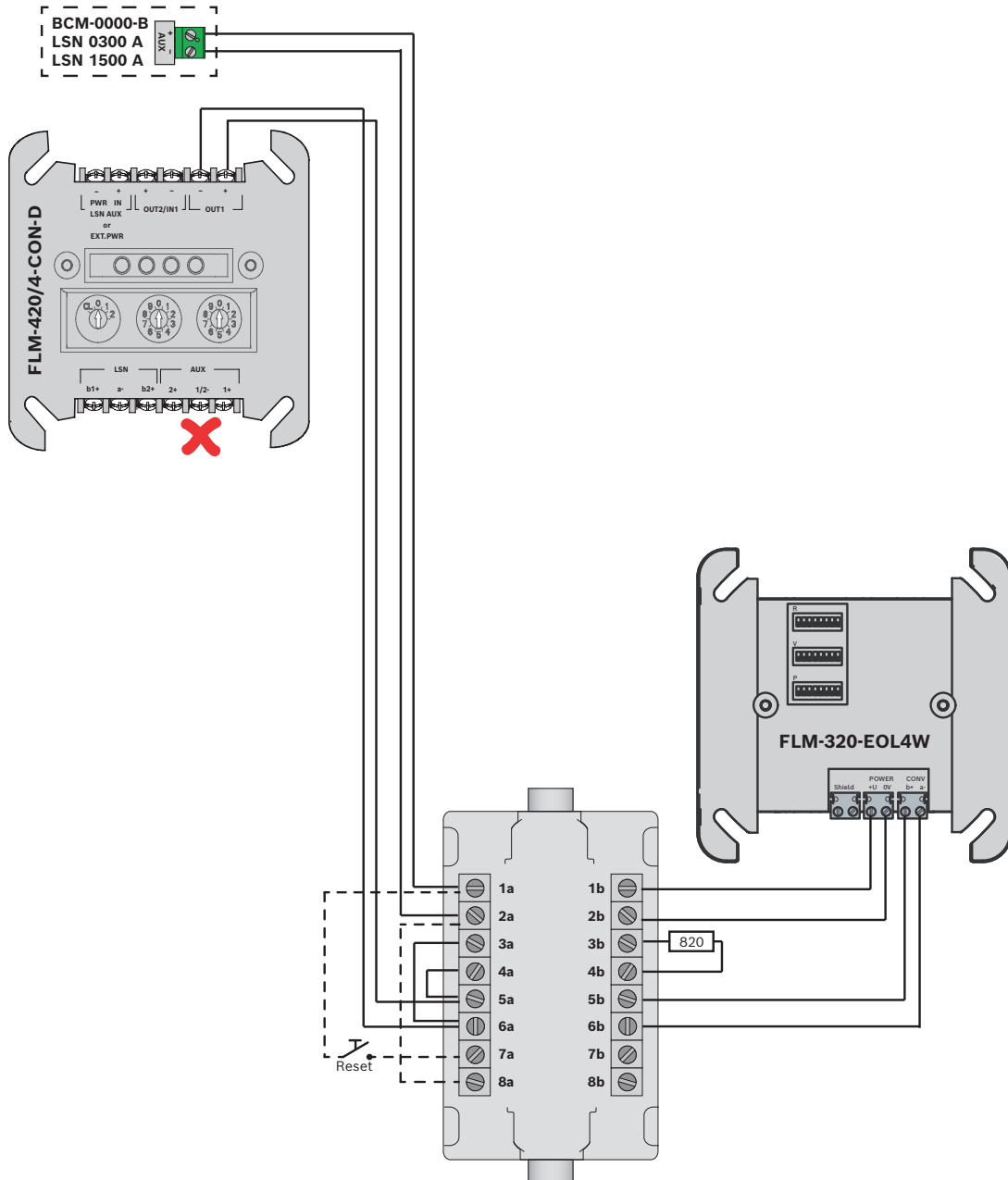

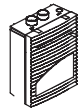

FCS-320-TP Series

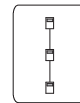

ELS

BCM-0000-B
LSN 0300 A
LSN 1500 A

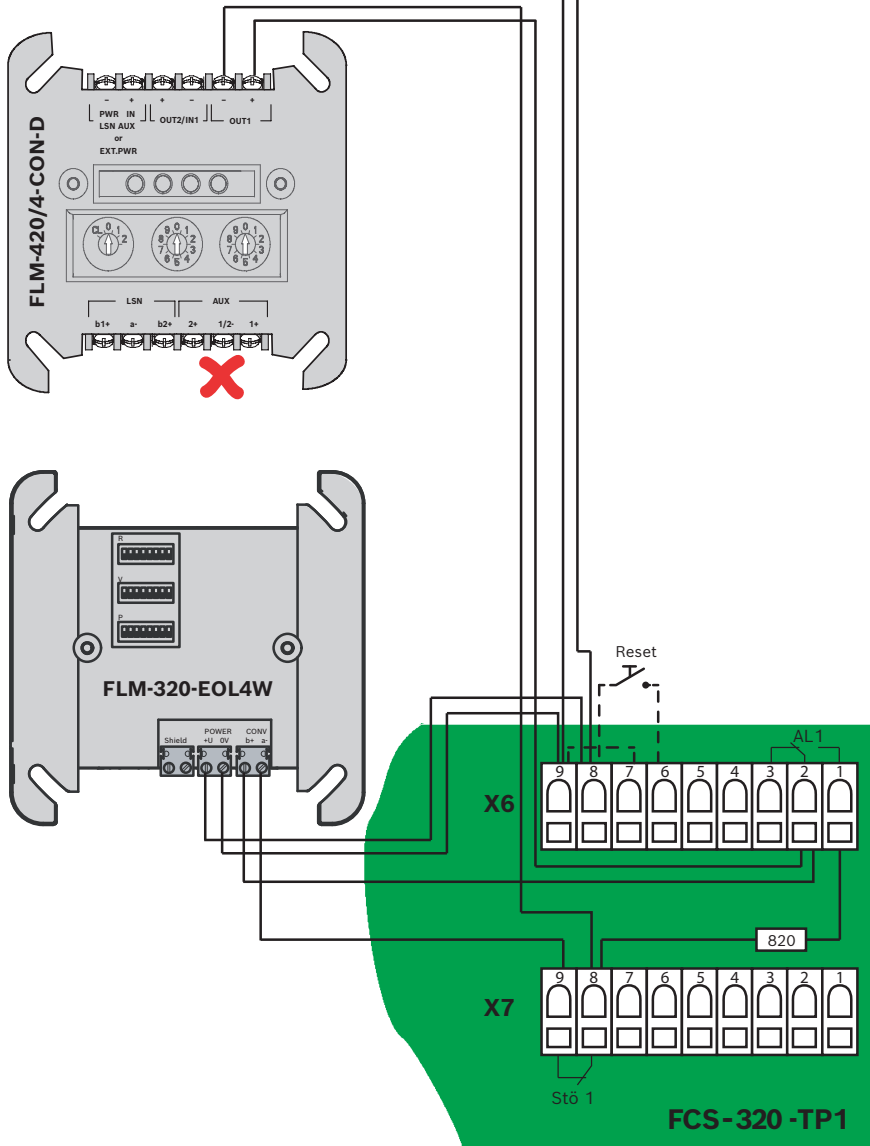

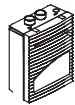

FCS-320-TP Series



ELS

BCM-0000-B
LSN 0300 A
LSN 1500 A

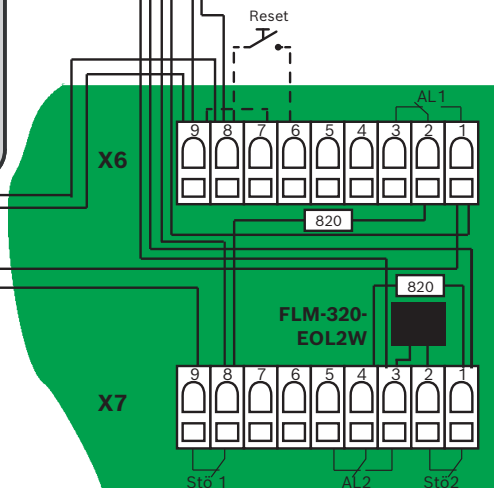
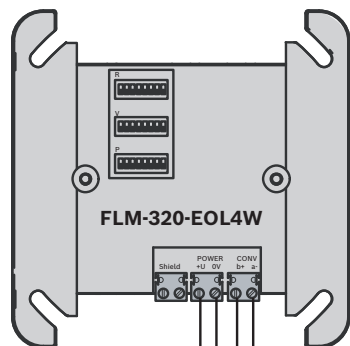
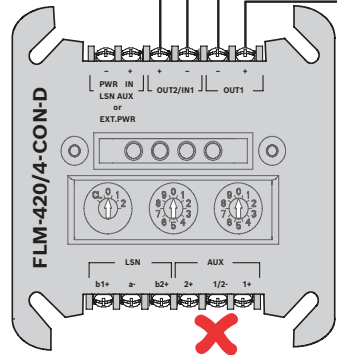

FCS-320-TP2

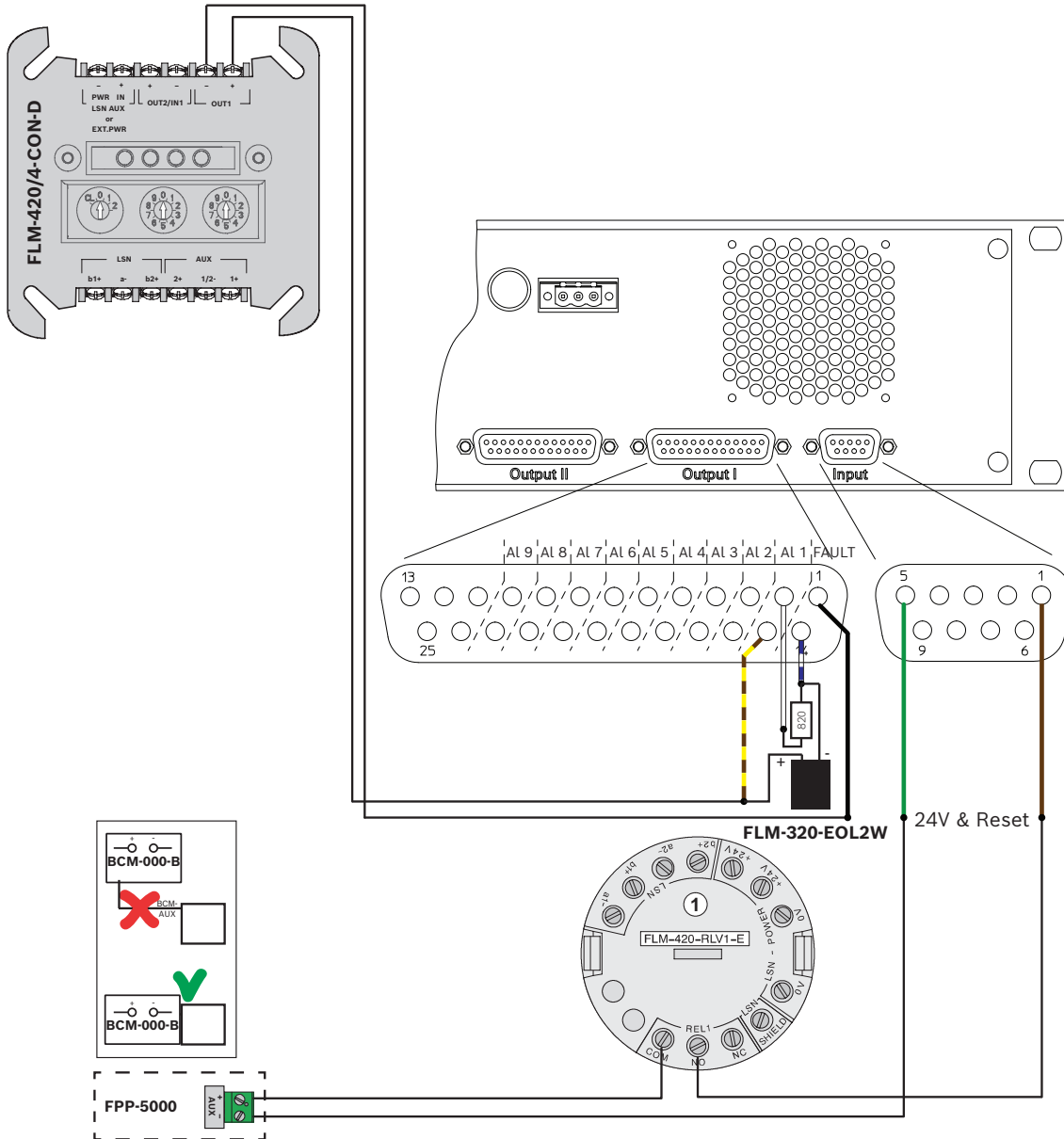
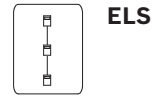

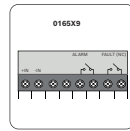

016519, 016589
IR3 Flame Detector

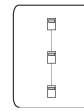

ELS

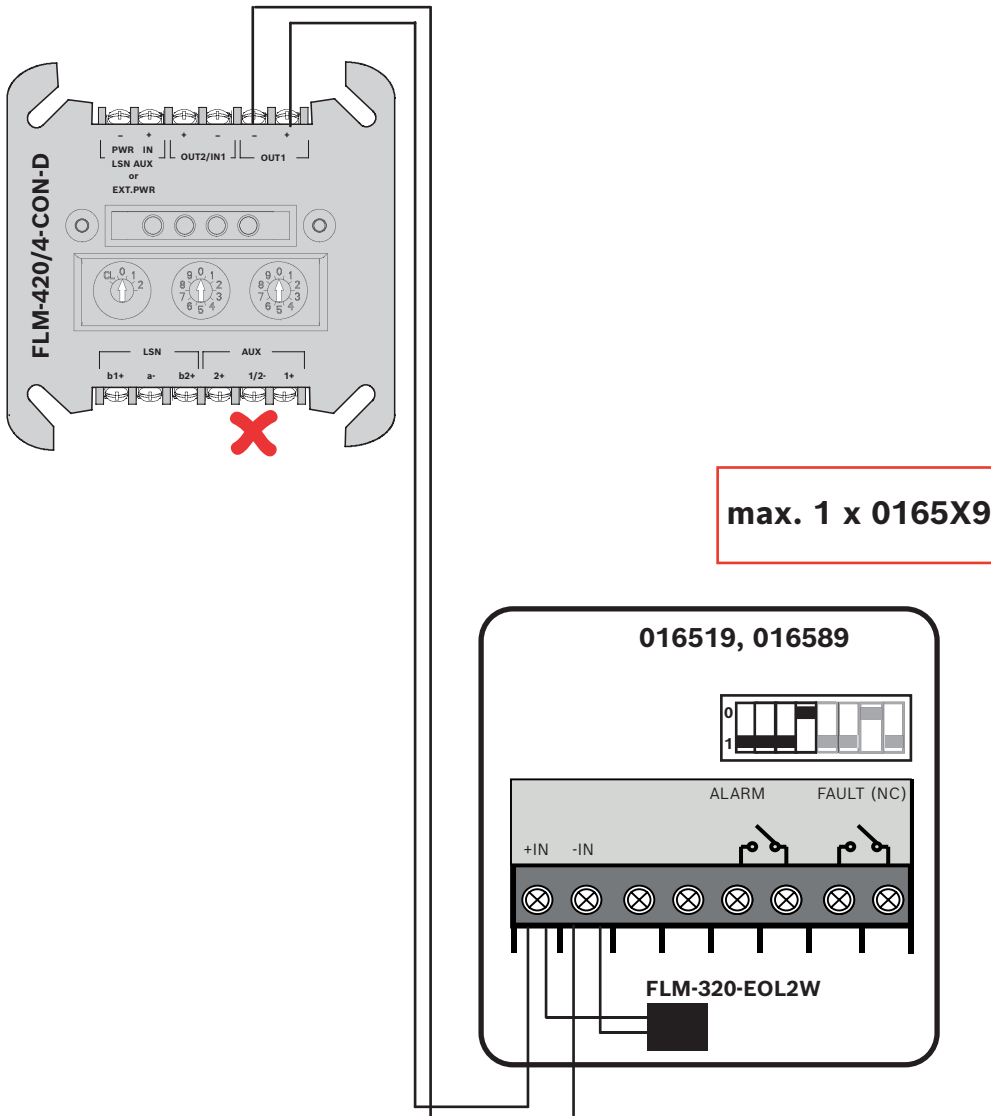

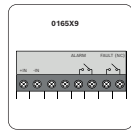

016519, 016589
IR3 Flame Detector

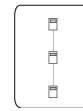

ELS

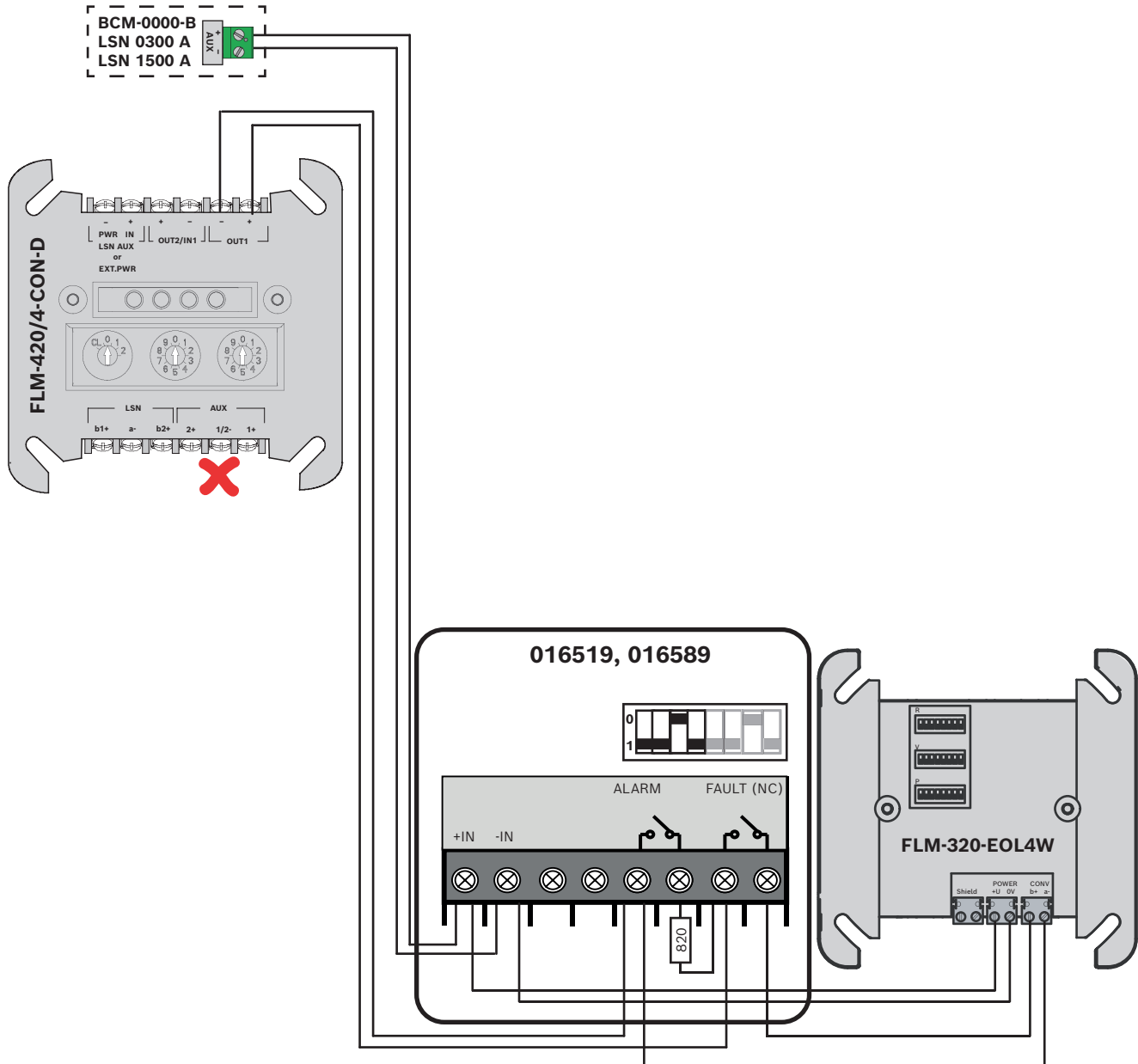



**Fireray 50RV
Fireray 100RV**

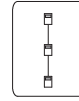

ELS

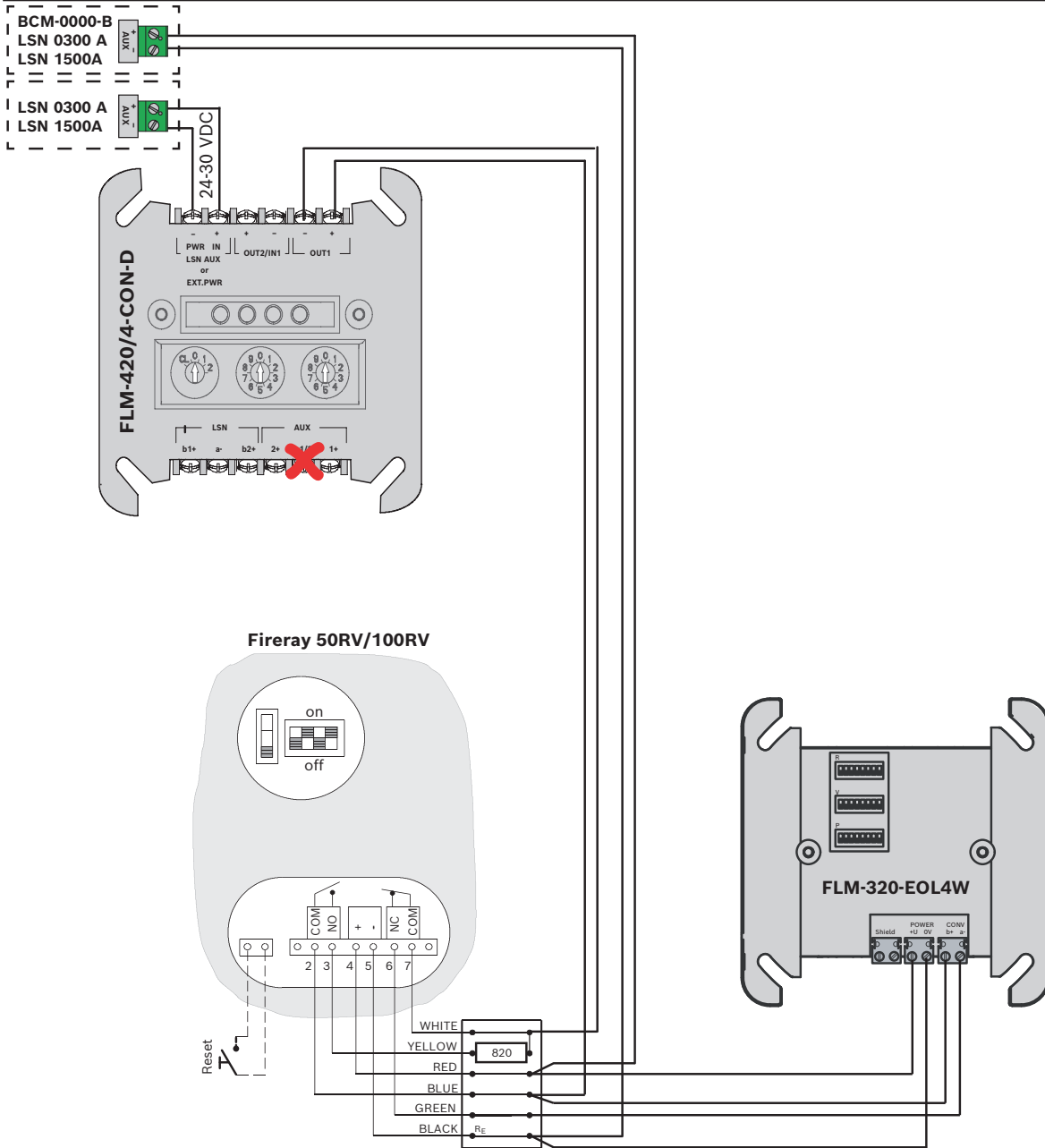



FIRERAY3000

1 x

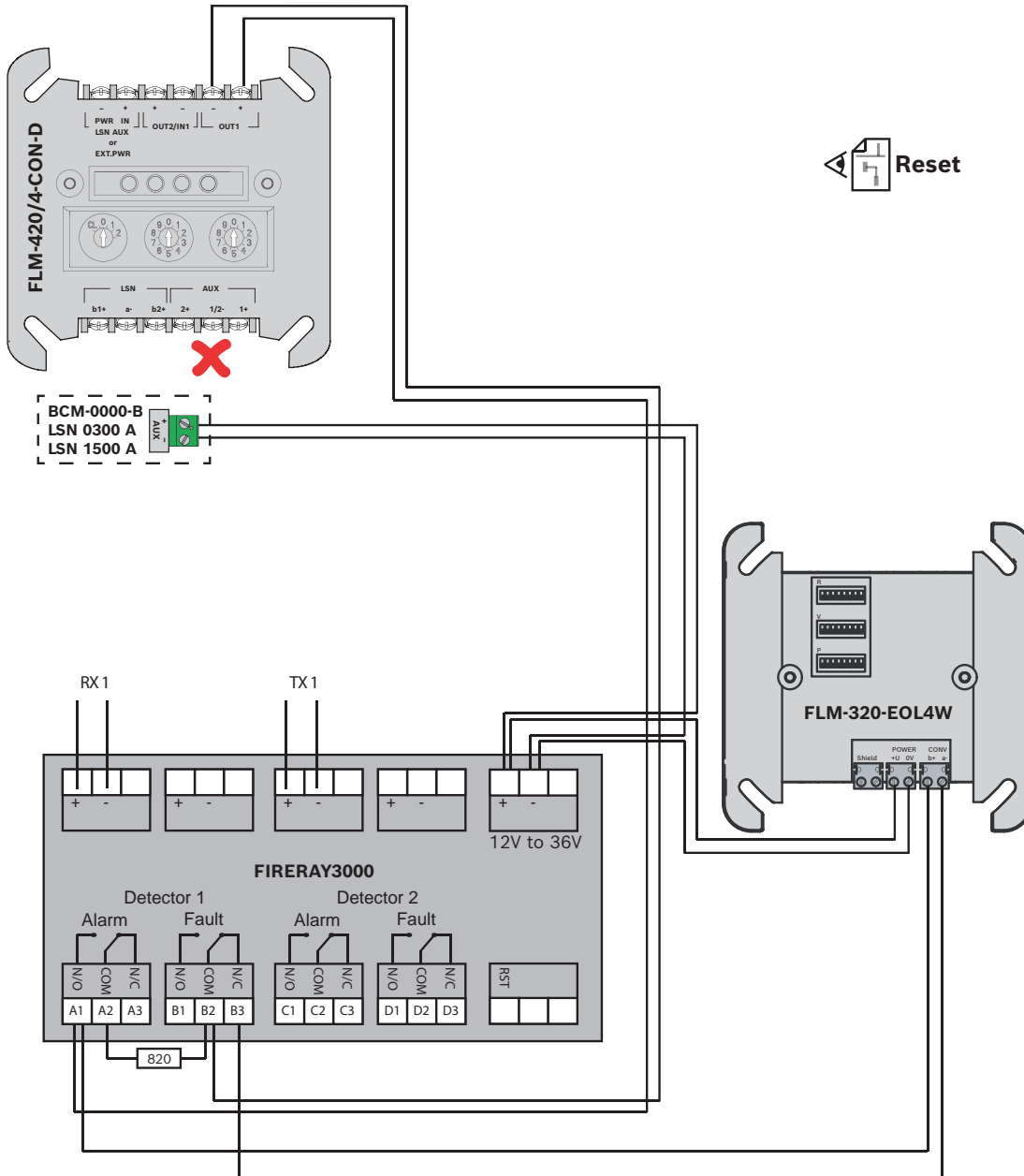
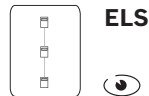



FIRERAY3000
2 x **OUT1**



ELS

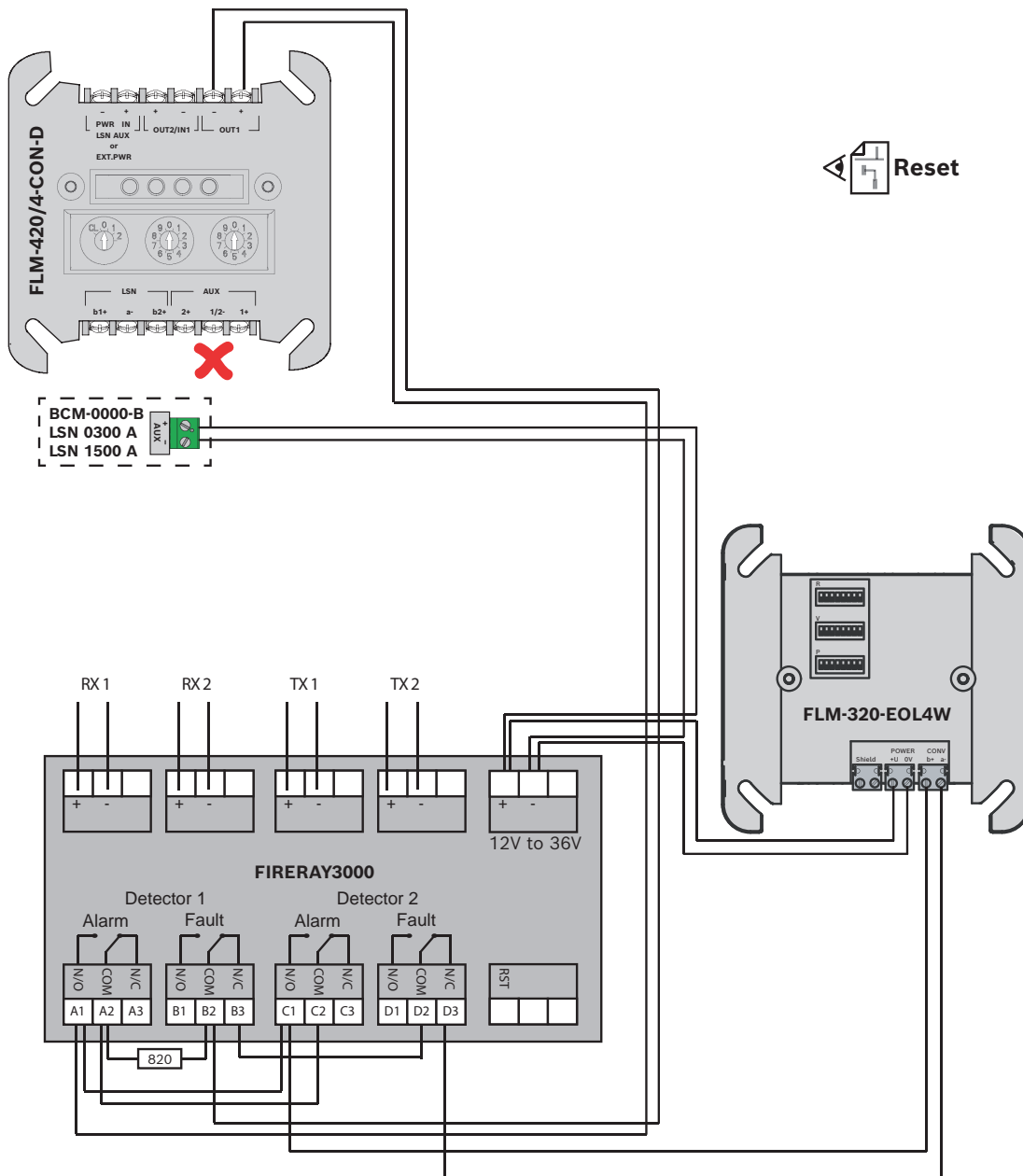



FIRERAY3000
2 x **OUT1+2**



ELS

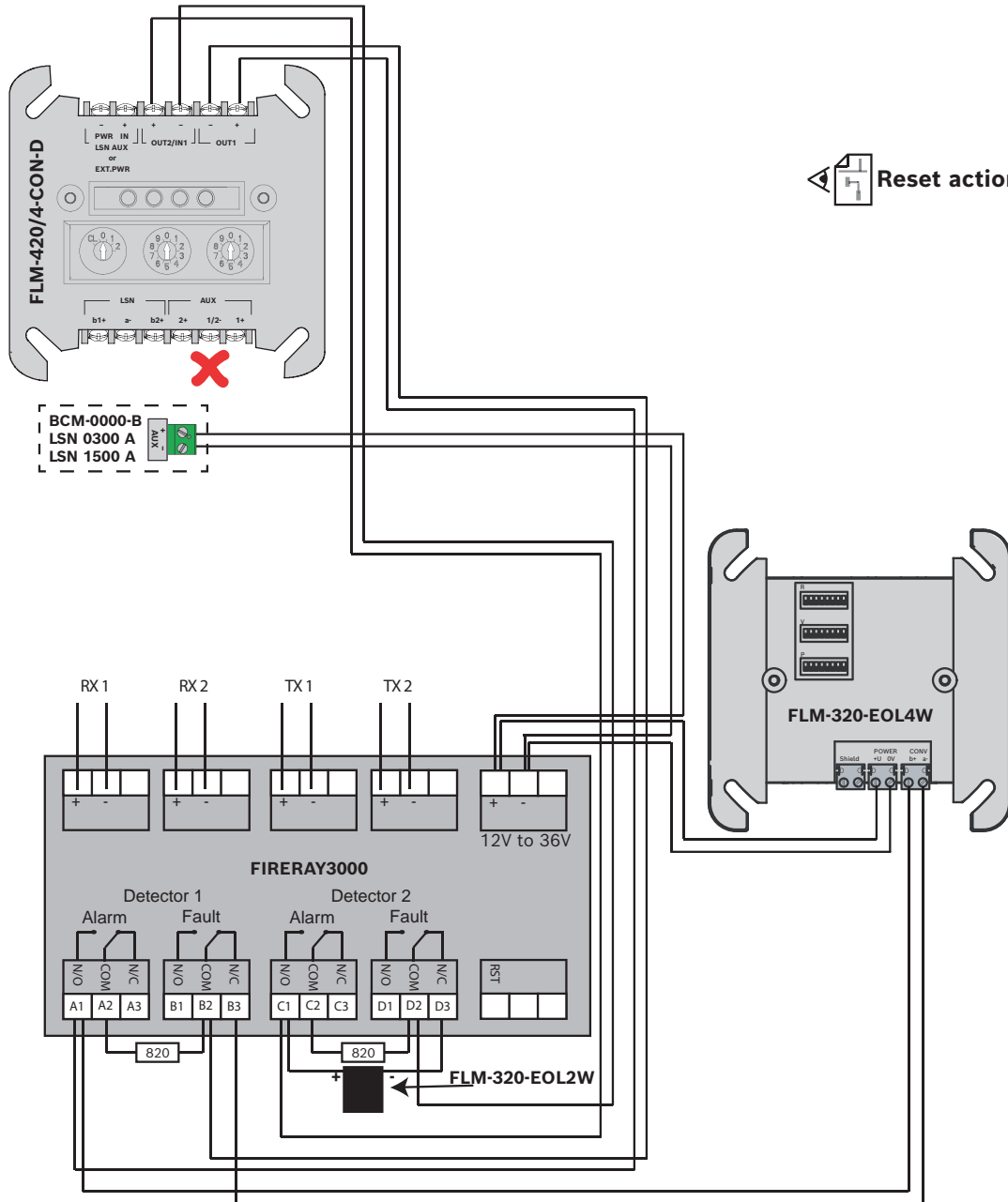



FIRERAY5000

1 x



ELS

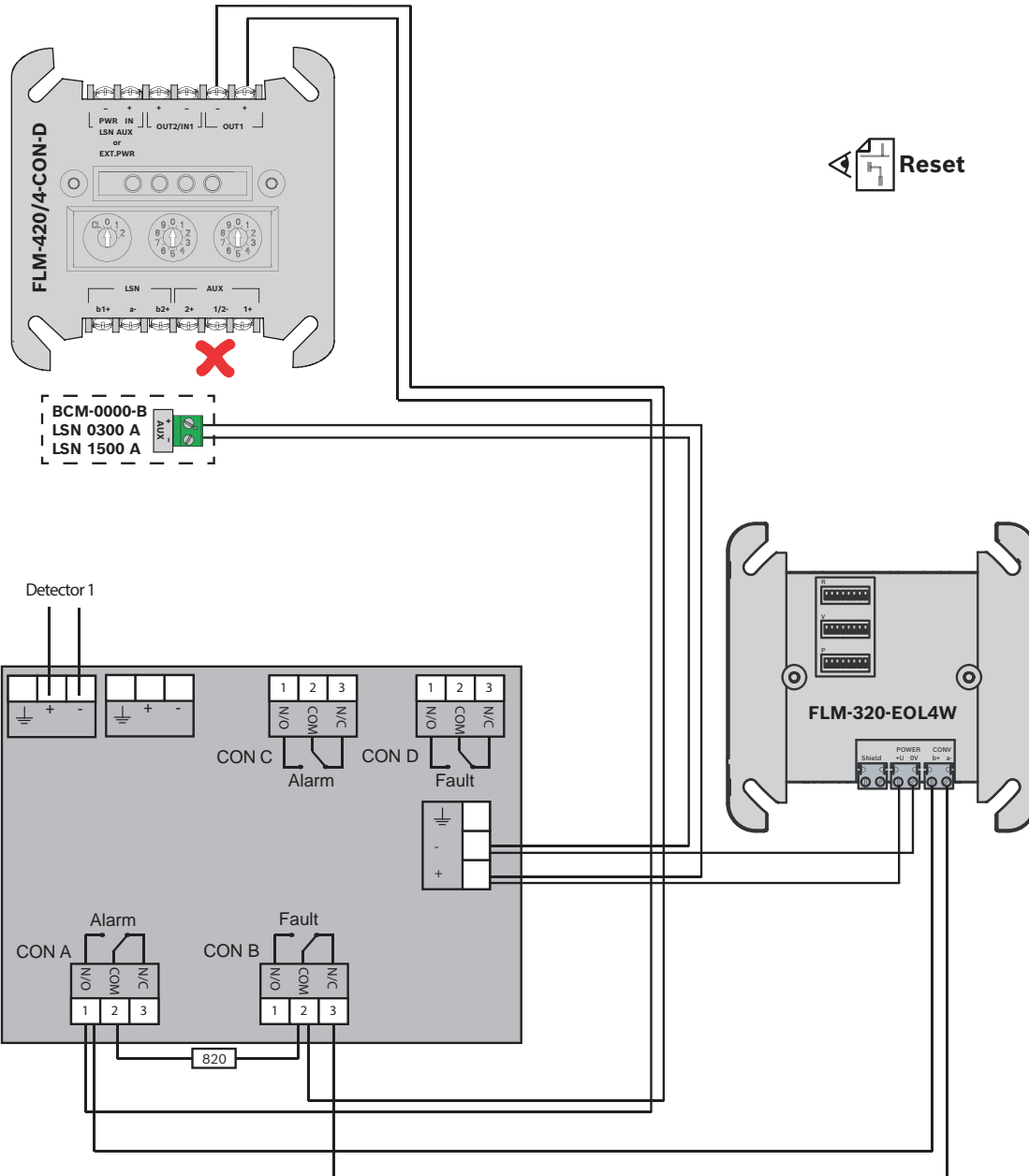



FIRERAY5000

2 x  **OUT1**



ELS

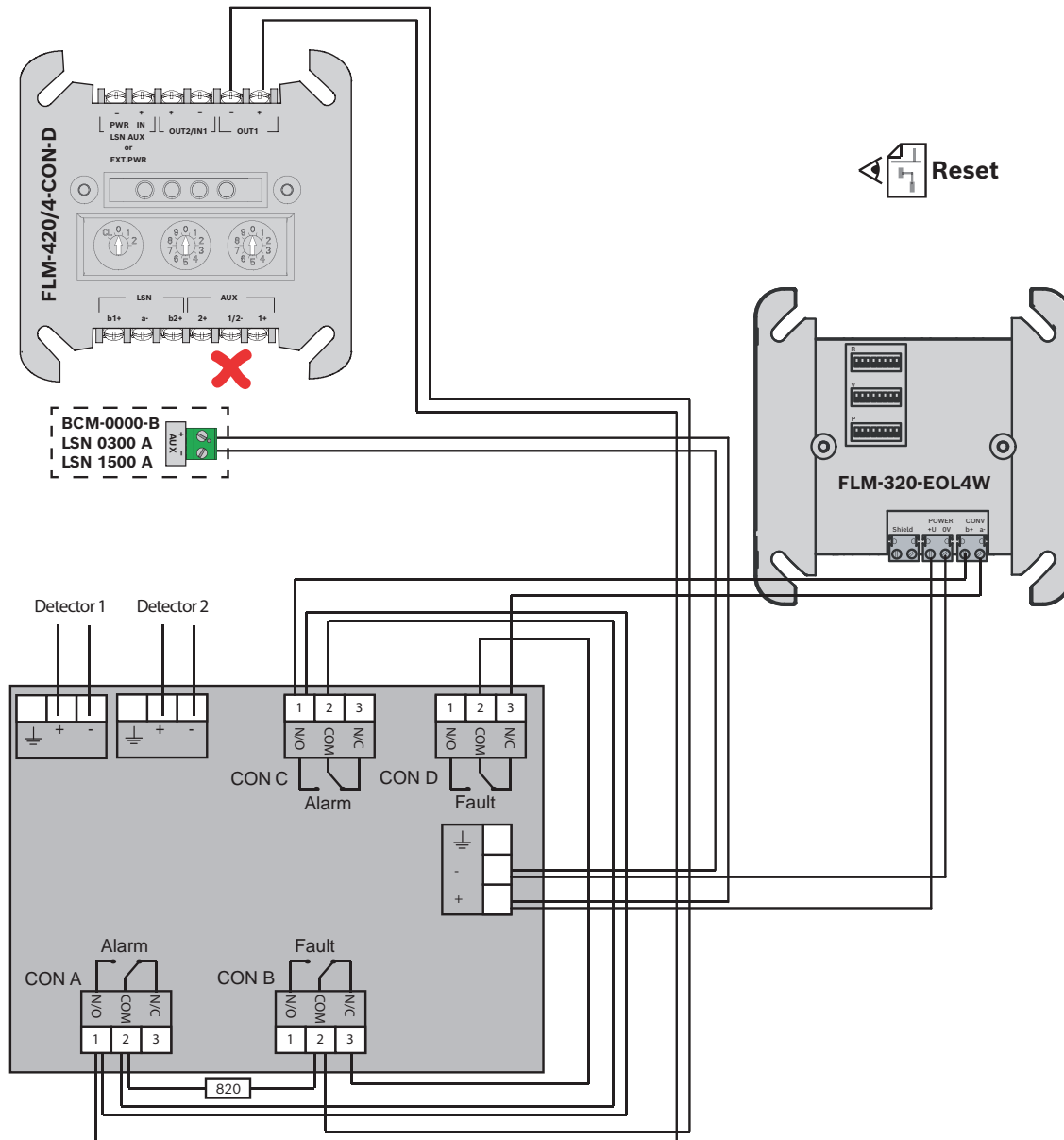



DC1192, SB3
 OOH740-A9-Ex
 DO1101A-Ex
 DT1101A-Ex/DT1102A-Ex
 DF1101-Ex
 DM1103B-Ex

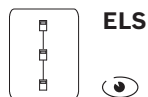

BCM-0000-B
 LSN 0300 A
 LSN 1500 A

BCM-0000-B
 LSN 0300 A
 LSN 1500 A

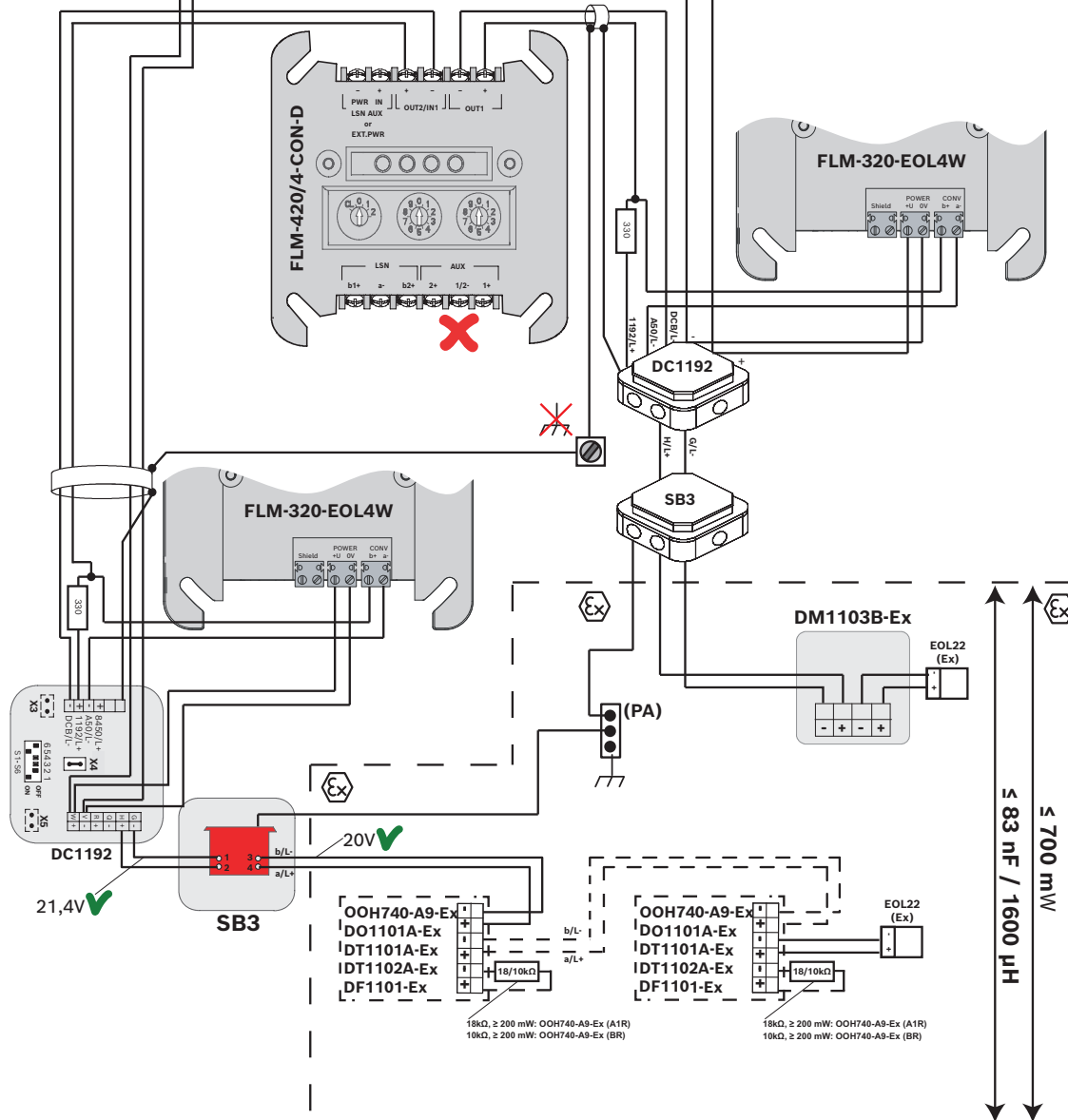

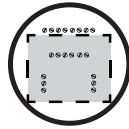
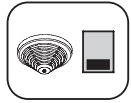

UniVario WMX5000
 UniVario FMX5000
 UniVario KMX5000

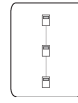

ELS

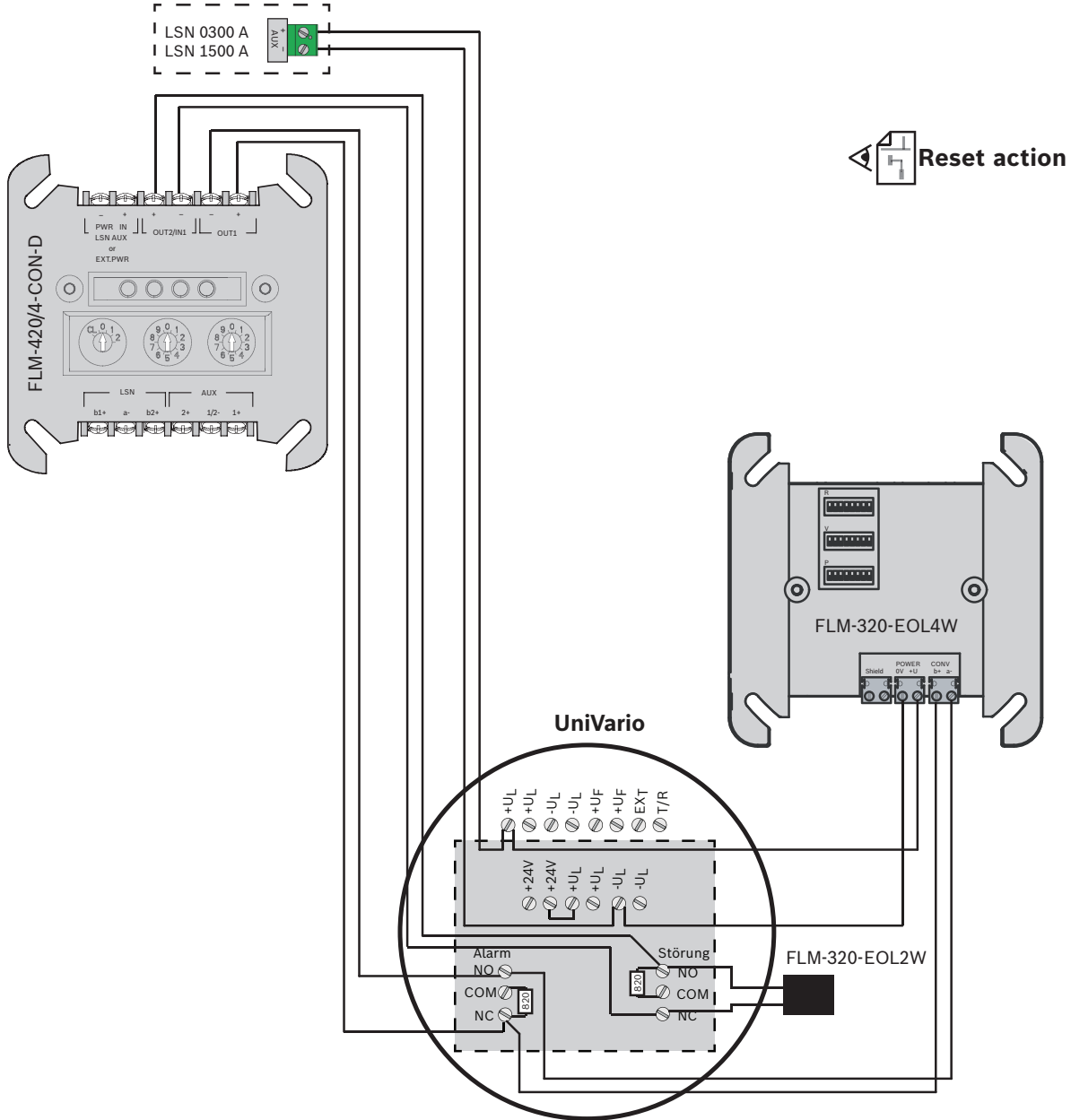

C		D	
C31B ->		DC1192, SB3 ->	
LSN 0300 A	103, 104	FLM-420/4-CON-D	149, 150
CZM 0004 A		FLM-420/4-CON-D (EOL)	271
016519	52, 53	DF 1192	
016589	52, 53	FAA-420-RI-DIN	151
FCA-500	58	DF 1192 ->	
FCS-320-TM	54	FLM-420/4-CON-D	151
FCS-320-TP1	55	DF1101-A-EX ->	
FCS-320-TP2	56	FLM-420/4-CON-D	149, 150
FCS-LWM-1	57	FLM-420/4-CON-D (EOL)	271
Fireray 100RV	45	DIBT	
Fireray 50RV	45	837 -> FAA-MSR 420	17, 18
FIRERAY3000	46, 47, 48	837 -> FLM-420-RHV	27, 28
FIRERAY5000	49, 50, 51	838 -> FAA-MSR 420	17, 18
FMC-120	59	838 -> FLM-420-RHV	27, 28
FMC-300	60	858 -> FAA-MSR 420	17, 18
		858 -> FLM-420-RHV	27, 28
		BTS 80 EMB -> FAA-MSR 420	19, 20
		BTS 80 EMB -> FLM-420-RHV	29, 30
		BTS 80 FLB -> FAA-MSR 420	19, 20
		BTS 80 FLB -> FLM-420-RHV	29, 30
		ED 100 -> FAA-MSR-420	15, 16
		ED 100 -> FLM-420-RHV	25, 26
		ED 250 -> FAA-MSR-420	15, 16
		ED 250 -> FLM-420-RHV	25, 26
		GT 40 R -> FAA-MSR 420	17, 18
		GT 40 R -> FLM-420-RHV	27, 28
		GT 42 R -> FAA-MSR 420	17, 18
		GT 42 R -> FLM-420-RHV	27, 28
		GT 50 R -> FAA-MSR 420	17, 18
		GT 50 R -> FLM-420-RHV	27, 28
		GT 60 R -> FAA-MSR 420	17, 18
		GT 60 R -> FLM-420-RHV	27, 28
		GT 63 R -> FAA-MSR 420	17, 18
		GT 63 R -> FLM-420-RHV	27, 28
		GT 70 R -> FAA-MSR 420	17, 18
		GT 70 R -> FLM-420-RHV	27, 28
		GT 70 R 050.01 Ex -> FAA-MSR 420	17, 18
		GT 70 R 050.01 Ex -> FLM-420-RHV	27, 28
		Slimdrive EMD-F -> FAA-MSR-420	21, 22
		Slimdrive EMD-F -> FLM-420-RHV	31, 32
		Slimdrive EMD-F-IS -> FAA-MSR-420	21, 22
		Slimdrive EMD-F-IS -> FLM-420-RHV	31, 32
		TS 4000 E -> FAA-MSR-420	23, 24
		TS 4000 E -> FLM-420-RHV	33, 34
		TS 4000 EFS -> FAA-MSR-420	23, 24
		TS 4000 EFS -> FLM-420-RHV	33, 34
		TS 4000 E-IS -> FAA-MSR-420	23, 24

TS 4000 E-IS -> FLM-420-RHV	33, 34	EOL	201, 202, 203
TS 5000 E -> FAA-MSR-420	23, 24	016519 -> FLM-420/4-CON-D	263, 264
TS 5000 E -> FLM-420-RHV	33, 34	016519 ->:CZM 0004 A	189, 190
TS 5000 E-IS -> FAA-MSR-420	23, 24	016589 -> FLM-420/4-CON-D	263, 264
TS 5000 E-IS -> FLM-420-RHV	33, 34	016589 ->:CZM 0004 A	190
TS 5000 E-ISM -> FAA-MSR-420	23, 24	ADW 535-1 -> FLM-420/4-CON-D	246
TS 5000 E-ISM -> FLM-420-RHV	33, 34	ADW 535-2 -> FLM-420/4-CON-D	247
TS 550 E -> FAA-MSR-420	23, 24	ALARMLINE II -> FLM-420/4-CON-D	248
TS 550 E -> FLM-420-RHV	33, 34	ASD 532 -> FLM-420/4-CON-D	251
TS 73 EMF -> FAA-MSR 420	19, 20	ASD 535-1 -> FLM-420/4-CON-D	252
TS 73 EMF -> FLM-420-RHV	29, 30	ASD 535-2 -> FLM-420/4-CON-D	253
TS 93 EMF -> FAA-MSR 420	19, 20	ATB 420 LSNi -> LSN 0300 A	233, 234, 235, 236
TS 93 EMF -> FLM-420-RHV	29, 30	ATG 420 LSNi -> LSN 0300 A	237, 238, 239, 240
TS 93 GSR/EMF1 -> FAA-MSR 420	19, 20	CZM 0004 A: FCS-320-TM	192
TS 93 GSR/EMF1 -> FLM-420-RHV	29, 30	CZM 0004 A: FCS-320-TP1	193
TS 93 GSR/EMF2 -> FAA-MSR 420	19, 20	CZM 0004 A: FCS-320-TP2	194
TS 93 GSR/EMF2 -> FLM-420-RHV	29, 30	CZM 0004 A: FIRERAY3000	195, 196, 197
TSA 160 NT F -> FAA-MSR-420	23, 24	CZM 0004 A: FIRERAY5000	198
TSA 160 NT F -> FLM-420-RHV	33, 34	CZM 0004 A: FMC-120	199
TSA 160 NT F-IS -> FAA-MSR-420	23, 24	CZM 0004 A: FMC-300	200
TSA 160 NT F-IS -> FLM-420-RHV	33, 34	CZM 0004 A:016519	190
TSA 160 NT F-IS/TS -> FAA-MSR-420	23, 24	CZM 0004 A:016589	189, 190
TSA 160 NT F-IS/TS -> FLM-420-RHV	33, 34	CZM 0004 A:FCA-500-EU	191
TSZ 0400 -> FLM-420/4-CON-D	36	CZM 0004A:016519	189
TSZ 0400 -> FLM-420-I2-E/-W	37	CZM 0004A:016589	189
TSZ 0400 -> FLM-420-O1I1-E	38	DC1192, SB3 -> FLM-420/4-CON-D	271
DM 1103B-X ->		DF1101-A-EX -> FLM-420/4-CON-D	271
FLM-420/4-CON-D	149, 150	DM 1103B-X -> FLM-420/4-CON-D	271
FLM-420/4-CON-D (EOL)	271	DO1101-A-EX -> FLM-420/4-CON-D	271
DO1101-A-EX ->		FAA-500 -> LSN 0300 A	220
FLM-420/4-CON-D	149, 150	FAA-500-R -> LSN 0300 A	220
FLM-420/4-CON-D (EOL)	271	FAA-MSR 420 -> LSN 0300 A	221
E		FAP-425	257
ED 100 ->		FAP-425 -> LSN 0300 A	221, 222
FAA-MSR-420	15, 16	FAP-520 -> LSN 0300 A	220
FLM-420-RHV	25, 26	FAS-420 -> LSN 0300 A	223, 224
ED 250 ->		FAS-420-TM -> LSN 0300 A	225, 226, 227, 228
FAA-MSR-420	15, 16	FBF 100 LSN -> LSN 0300 A	229, 230, 231, 232
FLM-420-RHV	25, 26	FCA-500-EU -> FLM-420/4-CON-D	258
ELS VdS 2489	7, 68	FCA-500-EU ->:CZM 0004 A	191
ENO 0000 A		FCH-320	257
TF2F	63	FCH-320 -> LSN 0300 A	222
ENO 0000 A/B		FCP-320	257
AT5000 IP/GPRS	61	FCP-320 -> LSN 0300 A	222
GÜ 101-B	66, 67	FCS-320-TM -> FLM-420/4-CON-D	259
MDL-F	62	FCS-320-TM ->:CZM 0004 A	192
UE-F-D/T	65	FCS-320-TP1 -> FLM-420/4-CON-D	260
ENO 0000 B		FCS-320-TP1 ->:CZM 0004 A	193
TF2F	64	FCS-320-TP2 -> FLM-420/4-CON-D	261

FCS-320-TP2 ->:CZM 0004 A	194	WMX-5000 -> FLM-420/4-CON-D	272
FCS-LHD-2 -> FLM-420/4-CON-D	248	F	
FCS-LWM-1 -> FLM-420/4-CON-D	254	FAA-420-RI-DIN ->	
FireRay 50RV/100RV -> FLM-420/4-CON-D	265	DF 1192	151
FIRERAY3000 -> FLM-420/4-CON-D	266, 267, 268	FAA-500	89, 220
FIRERAY3000 ->:CZM 0004 A	195, 196, 197	FAA-MSR 420	90, 221
FIRERAY5000 -> FLM-420/4-CON-D	269, 270	FAA-MSR-420	39, 40, 41
FIRERAY5000 ->:CZM 0004 A	198	FAD-0420	82
FLM-420/4-CON -> LSN 0300 A	212, 213	FAP-425	91, 222, 257
FLM-420-I2-D -> LSN 0300 A	205	FCA-500	58, 128, 129
FLM-420-I2-E/-W -> LSN 0300 A	206	FCA-500-EU	258
FLM-420-I8R1-S -> LSN 0300 A	207	FCH-320	91, 154, 222, 257
FLM-420-NAC-D -> LSN 0300 A	214, 215	FCP-320	91, 154, 222, 257
FLM-420-O1I1-D -> LSN 0300 A	205	FCS-LWM-1	57, 126, 127
FLM-420-O1I1-E -> LSN 0300 A	208	FNM-420-A-BS	87, 218
FLM-420-O8I2-S -> LSN 0300 A	209	FNM-420U-A-BS	87, 218
FLM-420-RHV -> LSN 0300 A	205	MS 400/MS 400 B	91, 154, 222, 257
FLM-420-RLV1-D -> LSN 0300 A	205	FAA-420-RI-ROW ->	
FLM-420-RLV1-E -> LSN 0300 A	210	FAA-MSR-420	39
FLM-I 420-S -> LSN 0300 A	211	FAA-500	
FMC-120 ->:CZM 0004 A	199	FAA-420-RI-DIN	89, 220
FMC-120-DKM -> FLM-420/4-CON-D	255	FAA-500 ->	
FMC-120-EST -> FLM-420/4-CON-D	255	LSN 0300 A	89
FMC-210-... -> LSN 0300 A	216	LSN 0300 A (EOL)	220
FMC-300 -> FLM-420/4-CON-D	256	FAA-500-R ->	
FMC-300 ->:CZM 0004 A	200	LSN 0300 A (EOL)	220
FNM-420-A/-B -> LSN 0300 A	217	FAA-MSR 420	
FNM-420-A-BS -> LSN 0300 A	218, 219	FAA-420-RI-DIN	90, 221
FNM-420U-A/-B -> LSN 0300 A	217	FAA-MSR 420 ->	
FNM-420U-A-BS -> LSN 0300 A	218, 219	63 R	17, 18
FNM-420V-A -> LSN 0300 A	217	837	17, 18
FNX-425U-RFRD ->:LSN 0300 A	241, 242	838	17, 18
FNX-425U-RFWH ->:LSN 0300 A	241, 242	858	17, 18
FNX-425U-WFRD ->:LSN 0300 A	241, 242	GT 40 R	17, 18
FNX-425U-WFWH ->:LSN 0300 A	241, 242	GT 42 R	17, 18
FWI-270 -> LSN 0300 A	243, 244, 245	GT 50 R	17, 18
KMX-5000 -> FLM-420/4-CON-D	272	GT 60 R	17, 18
LSN 0300 A:FNX-425U-RFRD	241, 242	GT 70 R	17, 18
LSN 0300 A:FNX-425U-RFWH	241, 242	GT 70 R 050.01 Ex	17, 18
LSN 0300 A:FNX-425U-WFRD	241, 242	LSN 0300 A	90
LSN 0300 A:FNX-425U-WFWH	241, 242	LSN 0300 A (EOL)	221
MS 400/MS 400 B -> FLM-420/4-CON-D	257	FAA-MSR 420 -> BTS 80 EMB	19, 20
MS 400/MS 400 B -> LSN 0300 A	222	FAA-MSR 420 -> BTS 80 FLB	19, 20
N4387A -> FLM-420/4-CON-D	262	FAA-MSR 420 -> TS 73 EMF	19, 20
OSID -> FLM-420/4-CON-D	250	FAA-MSR 420 -> TS 93 EMF	19, 20
Reset action	204	FAA-MSR 420 -> TS 93 GSR/EMF1	19, 20
thefirebeam -> FLM-420/4-CON-D	249		
Typ K -> FLM-420/4-CON-D	271		
UniVario -> FLM-420/4-CON-D	272		

FAA-MSR 420 -> TS 93 GSR/EMF2	19, 20	FCA-500-EU ->	
FAA-MSR-420		FLM-420/4-CON-D	128, 129
ED 100	15, 16	FLM-420/4-CON-D (EOL)	258
ED 250	15, 16	FCH-320	
FAA-420-RI-DIN	39, 40, 41	FAA-420-RI-DIN	91, 154, 222, 257
FAA-420-RI-ROW	39	FCH-320 ->	
Slimdrive EMD-F	21, 22	FLM-420/4-CON-D	154
Slimdrive EMD-F-IS	21, 22	FLM-420/4-CON-D (EOL)	257
TS 4000 E	23, 24	LSN 0300 A	91
TS 4000 EFS	23, 24	LSN 0300 A (EOL)	222
TS 4000 E-IS	23, 24	FCP-320	
TS 5000 E	23, 24	FAA-420-RI-DIN	91, 154, 222, 257
TS 5000 E-IS	23, 24	FCP-320 ->	
TS 5000 E-ISM	23, 24	FLM-420/4-CON-D	154
TS 550 E	23, 24	FLM-420/4-CON-D (EOL)	257
TSA 160 NT F	23, 24	LSN 0300 A	91
TSA 160 NT F-IS	23, 24	LSN 0300 A (EOL)	222
TSA 160 NT F-IS/TS	23, 24	FCP-500 ->	
FAD-0420		FLM-420/4-CON-D	128, 129
FAA-420-RI-DIN	82	FCS-320-TM ->	
FAD-420-HS-EN ->		CZM 0004 A	54
LSN 0300 A	82, 83	FCS-LWM-1	54
FAP-425		FLM-420/4-CON-D	130
FAA-420-RI-DIN	91, 222, 257	FLM-420/4-CON-D (EOL)	259
FAP-425 ->		FCS-320-TP1 ->	
FLM-420/4-CON-D	154	CZM 0004 A	55
FLM-420/4-CON-D (EOL)	257	FLM-420/4-CON-D	131, 133
LSN 0300 A	91	FLM-420/4-CON-D (EOL)	260
LSN 0300 A (EOL)	221, 222	FCS-320-TP2 ->	
FAP-520 ->		FLM-420/4-CON-D	132
LSN 0300 A	89	FLM-420/4-CON-D (EOL)	261
LSN 0300 A (EOL)	220	FCS-320-TP2->	
FAS-420 ->		CZM 0004 A	56
LSN 0300 A	84	FCS-LHD-2 ->	
LSN 0300 A (EOL)	223, 224	FLM-420/4-CON-D	125
FAS-420-TM ->		FLM-420/4-CON-D (EOL)	248
LSN 0300 A	85	FCS-LHD-2EN ->	
LSN 0300 A (EOL)	225, 226, 227, 228	FLM-420-I8R1-S	158, 159
FAT2002RE ->		FCS-LWM-1	
FPE-5000-UGM	123	FAA-420-RI-DIN	57, 126, 127
FBF 100 LSN ->		FCS-LWM-1 ->	
LSN 0300 A	96	CZM 0004 A	57
LSN 0300 A (EOL)	229, 230, 231, 232	FLM-420/4-CON-D	126, 127
FCA-500		FLM-420/4-CON-D (EOL)	254
FAA-420-RI-DIN	58, 128, 129	FireRay 100 RV ->	
FCA-500 ->		CZM 0004 A	45
CZM 0004 A	58	FLM-420/4-CON-D	138, 144
FCA-500-EU		FireRay 50 RV ->	
FAA-420-RI-DIN	258	CZM 0004 A	45

FLM-420/4-CON-D	138, 144	FCS-320-TP1 (EOL)	260
Fireray 50RV/100RV ->		FCS-320-TP2	132
FLM-420/4-CON-D (EOL)	265	FCS-320-TP2 (EOL)	261
FIRERAY3000 ->		FCS-LHD-2	125
CZM 0004 A	46, 47, 48	FCS-LHD-2 (EOL)	248
FLM-420/4-CON-D	139, 140, 141, 145, 146	FCS-LWM-1	126, 127
FLM-420/4-CON-D (EOL)	266, 267, 268	FCS-LWM-1 (EOL)	254
FIRERAY5000 ->		Fireray 100 RV	138, 144
CZM 0004 A	49, 50, 51	Fireray 50 RV	138, 144
FLM-420/4-CON-D	142, 143, 147, 148	Fireray 50RV/100RV (EOL)	265
FLM-420/4-CON-D (EOL)	269, 270	FIRERAY3000	139, 140, 141, 145, 146
FLM-420/4-CON ->		FIRERAY3000 (EOL)	266, 267, 268
LSN 0300 A	95	FIRERAY5000	142, 143, 147, 148
LSN 0300 A (EOL)	212, 213	FIRERAY5000 (EOL)	269, 270
FLM-420/4-CON-D		FMC-120-DKM	156
016519	134, 135, 136, 137	FMC-120-DKM (EOL)	255
016519 (EOL)	263, 264	FMC-120-EST (EOL)	255
016589	134, 135, 136, 137	FMC-300	152
016589 (EOL)	263, 264	FMC-300 (EOL)	256
2014/2 Ex	155	KMX-5000 (EOL)	272
2014/2 GLU-Ex	155	MS 400/MS 400 B	154
ADW 535-1 (EOL)	246	MS 400/MS 400 B (EOL)	257
ADW 535-2 (EOL)	247	N4387A	153
ALARMLINE II	125	N4387A (EOL)	262
ALARMLINE II (EOL)	248	NO-Relay	157
ASD 532 (EOL)	251	OSID (EOL)	250
ASD 535-1 (EOL)	252	thefirebeam (EOL)	249
ASD 535-2 (EOL)	253	TSZ 0400	36
DC1192, SB3	149, 150	Typ K (EOL)	271
DC1192, SB3 (EOL)	271	UniVario (EOL)	272
DF 1192	151	WMX-5000 (EOL)	272
DF1101-A-EX	149, 150	FLM-420-I2-D ->	
DF1101-A-EX (EOL)	271	FPP-3000	13
DM 1103B-X	149, 150	LSN 0300 A	69
DM 1103B-X (EOL)	271	LSN 0300 A (EOL)	205
DO1101-A-EX	149, 150	FLM-420-I2-E ->	
DO1101-A-EX (EOL)	271	FPP-3000	13
FAP-425	154	FLM-420-I2-E/-W	
FAP-425 (EOL)	257	TSZ 0400	37
FCA-500-EU	128, 129	FLM-420-I2-E/-W ->	
FCA-500-EU (EOL)	258	LSN 0300 A	70
FCH-320	154	LSN 0300 A (EOL)	206
FCH-320 (EOL)	257	FLM-420-I2-W ->	
FCP-320	154	FPP-3000	13
FCP-320 (EOL)	257	FLM-420-I8R1-S	
FCP-500	128, 129	FCS-LHD-2EN	158, 159
FCS-320-TM	130	FLM-420-I8R1-S ->	
FCS-320-TM (EOL)	259	FPP-3000	13
FCS-320-TP1	131, 133	LSN 0300 A	71

LSN 0300 A (EOL)	207	TS 5000 E	33, 34
FLM-420-NAC-D		TS 5000 E-IS	33, 34
FNM-320	170, 171	TS 5000 E-ISM	33, 34
FNS-320	168, 169	TS 550 E	33, 34
FPP-5000	43	TS 73 EMF	29, 30
PA 10	162, 163	TS 93 EMF	29, 30
PA 5	160, 161	TS 93 GSR/EMF1	29, 30
PB 2005	166, 167	TS 93 GSR/EMF2	29, 30
PY X-M-10-SSM R	164, 165	TSA 160 NT F	33, 34
PY X-M-10-SSM W	164, 165	TSA 160 NT F-IS	33, 34
ROLP-R-LX	170, 171	TSA 160 NT F-IS/TS	33, 34
ROLP-W-LX	170, 171	FLM-420-RHV ->	
SOL-LX	168, 169	63 R	27, 28
FLM-420-NAC-D ->		837	27, 28
FPP-3000	14	838	27, 28
FPP-5000	44	858	27, 28
LSN 0300 A	74, 75	GT 40 R	27, 28
LSN 0300 A (EOL)	214, 215	GT 42 R	27, 28
LSN 300 A, BCM 0000 B	76	GT 50 R	27, 28
FLM-420-O1I1-D ->		GT 60 R	27, 28
LSN 0300 A	78, 79	GT 70 R	27, 28
LSN 0300 A (EOL)	205	GT 70 R 050.01 Ex	27, 28
FLM-420-O1I1-E		LSN 0300 A	69
TSZ 0400	38	LSN 0300 A (EOL)	205
FLM-420-O1I1-E ->		FLM-420-RLE-S	
LSN 0300 A	80	LA	184
LSN 0300 A (EOL)	208	FLM-420-RLE-S ->	
FLM-420-O8I2-S ->		LSN 0300 A	77
FPP-3000	13	FLM-420-RLV1-D ->	
LSN 0300 A	72, 73	LSN 0300 A	69
LSN 0300 A (EOL)	209	LSN 0300 A (EOL)	205
FLM-420-RHV		FLM-420-RLV1-E	
ADW 535-1	178, 179	Plena	185
ADW 535-2	180, 181	FLM-420-RLV1-E ->	
ASD 532	176, 177	LSN 0300 A	70
ASD 535-1	172, 173	LSN 0300 A (EOL)	210
ASD 535-2	174, 175	FLM-420-RLV8-S	
ASD 535-3	172, 173	Plena	186
ASD 535-4	174, 175	FLM-420-RLV8-S ->	
BTS EMB	29, 30	LSN 0300 A	81
BTS FLB	29, 30	FLM-I 420-S ->	
ED 100	25, 26	LSN 0300 A	69
ED 250	25, 26	LSN 0300 A (EOL)	211
FRAY-ONE-EN	182, 183	FMC-120->	
Slimdrive EMD-F	31, 32	CZM 0004 A	59
Slimdrive EMD-F-IS	31, 32	FMC-120-DKM ->	
TS 4000 E	33, 34	FLM-420/4-CON-D	156
TS 4000 EFS	33, 34	FLM-420/4-CON-D (EOL)	255
TS 4000 E-IS	33, 34	FMC-120-EST ->	

FLM-420/4-CON-D (EOL)	255	FMF-FBF-FAT ->FMF-ADP-FBF	187
FMC-210-... ->		FMF-FIBS ->	
LSN 0300 A	100	FPE-5000-UGM	122, 123
LSN 0300 A (EOL)	216	IOS 0020 A	121
FMC-210-IP66-R ->		FNM-320 ->	
LSN 0300 A	101	FLM-420-NAC-D	170, 171
FMC-300 ->		NZM 0002 A	114, 115
FLM-420/4-CON-D	152	FNM-420-A/-B ->	
FLM-420/4-CON-D (EOL)	256	LSN 0300 A	86
FMC-300->		LSN 0300 A (EOL)	217
CZM 0004 A	60	FNM-420-A-BS	
FMC-420RW ->		FAA-420-RI-DIN	87, 218
LSN 0300 A	102	FNM-420-A-BS ->	
FMF-ADP ->		LSN 0300 A	87, 88
FPE-5000-UGM	122, 123	LSN 0300 A (EOL)	218, 219
IOS 0020 A	121	FNM-420U-A/-B ->	
FMF-ADP-FAT		LSN 0300 A	86
FMF-FAT	187	LSN 0300 A (EOL)	217
FMF-FBF-FAT	187	FNM-420U-A-BS	
FMF-FAT ->		FAA-420-RI-DIN	87, 218
FPE-5000-UGM	122	FNM-420U-A-BS ->	
IOS 0020 A	121	LSN 0300 A	87, 88
FMF-FAT ->FMF-ADP-FBF	187	LSN 0300 A (EOL)	218, 219
FMF-FBF-FAT ->		FNM-420V-A ->	
FPE-5000-UGM	122, 123	LSN 0300 A	86
IOS 0020 A	121	LSN 0300 A (EOL)	217
		FNS-320 ->	
		FLM-420-NAC-D	168, 169
		NZM 0002 A	111, 112, 113
		FNS-P400RTH ->	
		RMH 0002 A	119
		FNX-425U-RFRD ->	
		LSN 0300 A	98, 99
		LSN 0300 A (EOL)	241, 242
		FNX-425U-RFWH ->	
		LSN 0300 A	98, 99
		LSN 0300 A (EOL)	241, 242
		FNX-425U-WFRD ->	
		LSN 0300 A	98, 99
		LSN 0300 A (EOL)	241, 242
		FNX-425U-WFWH ->	
		LSN 0300 A	98, 99
		LSN 0300 A (EOL)	241, 242
		FPE-5000-UGM	
		FAT2002RE	123
		FMF-ADP	122, 123
		FMF-FAT	122
		FMF-FBF-FAT	122, 123
		FMF-FIBS	122, 123

FPP-3000			
FLM-420-I2-D	13		
FLM-420-I2-E	13		
FLM-420-I2-W	13		
FLM-420-I8R1-S	13		
FLM-420-NAC-D	14		
FLM-420-O8I2-S	13		
FPP-5000			
FLM-420-NAC-D	44		
FPP-5000 ->			
FLM-420-NAC-D	43		
FPP-5000-TI			
BCM-0000-B	11		
FPP-5000-TI13			
BCM-0000-B	12		
FRAY-ONE-EN ->			
FLM-420-RHV	182, 183		
FWI-270 ->			
LSN 0300 A	105		
LSN 0300 A (EOL)	243, 244, 245		
G			
GSME-L3 ->			
LSN 0300 A	92		
GT 40 R ->			
FAA-MSR 420	17, 18		
FLM-420-RHV	27, 28		
GT 42 R ->			
FAA-MSR 420	17, 18		
FLM-420-RHV	27, 28		
GT 50 R ->			
FAA-MSR 420	17, 18		
FLM-420-RHV	27, 28		
GT 60 R ->			
FAA-MSR 420	17, 18		
FLM-420-RHV	27, 28		
GT 63 R ->			
FAA-MSR 420	17, 18		
FLM-420-RHV	27, 28		
GT 70 R ->			
FAA-MSR 420	17, 18		
FLM-420-RHV	27, 28		
GT 70 R 050.01 Ex ->			
FAA-MSR 420	17, 18		
FLM-420-RHV	27, 28		
GÜ 101-B ->			
ENO 0000 A/B	66, 67		
I			
IOS 0020 A			
FMF-ADP		121	
FMF-FAT		121	
FMF-FBF-FAT		121	
FMF-FIBS		121	
Plena		120	
K			
KMX-5000 ->			
FLM-420/4-CON-D (EOL)		272	

L					
LA ->					
FLM-420-RLE-S		184		FLM-420-RLV1-D	69
LSN 0300 A (FLM-420-RLE-S)		97		FLM-420-RLV1-D (EOL)	205
LSN 0300 A				FLM-420-RLV1-E	70
ATB 420 LSNi		93		FLM-420-RLV1-E (EOL)	210
ATB 420 LSNi (EOL)	233, 234, 235, 236			FLM-420-RLV8-S	81
ATG 420 LSNi		94		FLM-I 420-S	69
ATG 420 LSNi (EOL)	237, 238, 239, 240			FLM-I 420-S (EOL)	211
C31B		103, 104		FMC-210-...	100
FAA-500		89		FMC-210-... (EOL)	216
FAA-500 (EOL)		220		FMC-210-IP66-R	101
FAA-500-R (EOL)		220		FMC-420RW	102
FAA-MSR 420		90		FNM-420-A/-B	86
FAA-MSR 420 (EOL)		221		FNM-420-A/-B (EOL)	217
FAD-420-HS-EN		82, 83		FNM-420-A-BS	87, 88
FAP-425		91		FNM-420-A-BS (EOL)	218, 219
FAP-425 (EOL)	221, 222			FNM-420U-A/-B	86
FAP-520		89		FNM-420U-A/-B (EOL)	217
FAP-520 (EOL)		220		FNM-420U-A-BS	87, 88
FAS-420		84		FNM-420U-A-BS (EOL)	218, 219
FAS-420 (EOL)	223, 224			FNM-420V-A	86
FAS-420-TM		85		FNM-420V-A (EOL)	217
FAS-420-TM (EOL)	225, 226, 227, 228			FNX-425U-RFRD	98, 99
FBF 100 LSN		96		FNX-425U-RFRD (EOL)	241, 242
FBF 100 LSN (EOL)	229, 230, 231, 232			FNX-425U-RFWH	98, 99
FCH-320		91		FNX-425U-RFWH (EOL)	241, 242
FCH-320 (EOL)		222		FNX-425U-WFRD	98, 99
FCP-320		91		FNX-425U-WFRD (EOL)	241, 242
FCP-320 (EOL)		222		FNX-425U-WFWH	98, 99
FLM-420/4-CON		95		FNX-425U-WFWH (EOL)	241, 242
FLM-420/4-CON (EOL)	212, 213			FWI-270	105
FLM-420-I2-D		69		FWI-270 (EOL)	243, 244, 245
FLM-420-I2-D (EOL)		205		GSME-L3	92
FLM-420-I2-E/-W		70		LA (FLM-420-RLE-S)	97
FLM-420-I2-E/-W (EOL)		206		MS 400/MS 400 B	91
FLM-420-I8R1-S		71		MS 400/MS 400 B (EOL)	222
FLM-420-I8R1-S (EOL)		207			
FLM-420-NAC-D		74, 75		M	
FLM-420-NAC-D (EOL)	214, 215			MDL-F ->	
FLM-420-O1I1-D		78, 79		ENO 0000 A/B	62
FLM-420-O1I1-D (EOL)		205		MS 400	
FLM-420-O1I1-E		80		TSZ 0400 (FCP-O320 / FCH-T320 FSA)	35
FLM-420-O1I1-E (EOL)		208		MS 400/MS 400 B	
FLM-420-O8I2-S	72, 73			FAA-420-RI-DIN	91, 154, 222, 257
FLM-420-O8I2-S (EOL)		209		MS 400/MS 400 B ->	
FLM-420-RHV		69		FLM-420/4-CON-D	154
FLM-420-RHV (EOL)		205		FLM-420/4-CON-D (EOL)	257
FLM-420-RLE-S		77		LSN 0300 A	91
				LSN 0300 A (EOL)	222

N

N4387A ->	
FLM-420/4-CON-D	153
FLM-420/4-CON-D (EOL)	262
NO-Relay ->	
FLM-420/4-CON-D	157
NZM 0002 A	
FNM-320	114, 115
FNS-320	111, 112, 113
NZM 0002 A	110
PA 10	108, 109
PA 5	106, 107
PB 2005	116, 117, 118
ROLP-W-LX	114, 115
SOL-LX	111, 112, 113
NZM 0002 A ->	
NZM 0002 A	110

O

OSID ->	
FLM-420/4-CON-D (EOL)	250

P

PA 10 ->	
FLM-420-NAC-D	162, 163
NZM 0002 A	108, 109
PA 5 ->	
FLM-420-NAC-D	160, 161
NZM 0002 A	106, 107
PB 2005 ->	
FLM-420-NAC-D	166, 167
NZM 0002 A	116, 117, 118
Plena ->	
FLM-420-RLV1-E	185
FLM-420-RLV8-S	186
IOS 0020 A	120
PY X-M-10-SSM R ->	
FLM-420-NAC-D	164, 165
PY X-M-10-SSM W ->	
FLM-420-NAC-D	164, 165

R

Redundancy	
ENO	67
LSN 0300 A	97
NZM 0002 A	110
Panel controller	97

Reset action	204
RMH 0002 A	
FNS-P400RTH	119
ROLP-R-LX ->	
FLM-420-NAC-D	170, 171
ROLP-W-LX ->	
FLM-420-NAC-D	170, 171
NZM 0002 A	114, 115

Simboli]

Slimdrive EMD-F ->	
FAA-MSR-420	21, 22
FLM-420-RHV	31, 32
Slimdrive EMD-F-IS ->	
FAA-MSR-420	21, 22
FLM-420-RHV	31, 32
SOL-LX ->	
FLM-420-NAC-D	168, 169
NZM 0002 A	111, 112, 113

T			
TF2F ->			
ENO 0000 A	63	FLM-420-RHV	33, 34
ENO 0000 B	64	TSZ 0400 ->	
thefirebeam ->		FLM-420/4-CON-D	36
FLM-420/4-CON-D (EOL)	249	FLM-420-I2-E/-W	37
TS 4000 E ->		FLM-420-O1I1-E	38
FAA-MSR-420	23, 24	MS 400 (FCP-O320 / FCH-T320 FSA)	35
FLM-420-RHV	33, 34	Typ K ->	
TS 4000 EFS ->		FLM-420/4-CON-D (EOL)	271
FAA-MSR-420	23, 24	U	
FLM-420-RHV	33, 34	UE-F-D/T ->	
TS 4000 E-IS ->		ENO 0000 A/B	65
FAA-MSR-420	23	UniVario ->	
FLM-420-RHV	33, 34	FLM-420/4-CON-D (EOL)	272
TS 4000 E-IS->		W	
FAA-MSR-420	24	WMX-5000 ->	
TS 5000 E ->		FLM-420/4-CON-D (EOL)	272
FAA-MSR-420	23, 24		
FLM-420-RHV	33, 34		
TS 5000 E-IS ->			
FAA-MSR-420	23, 24		
FLM-420-RHV	33, 34		
TS 5000 E-ISM ->			
FAA-MSR-420	23, 24		
FLM-420-RHV	33, 34		
TS 550 E ->			
FAA-MSR-420	23, 24		
FLM-420-RHV	33, 34		
TS 73 EMF ->			
FAA-MSR 420	19, 20		
FLM-420-RHV	29, 30		
TS 93 EMF ->			
FAA-MSR 420	19, 20		
FLM-420-RHV	29, 30		
TS 93 GSR/EMF1 ->			
FAA-MSR 420	19, 20		
FLM-420-RHV	29, 30		
TS 93 GSR/EMF2 ->			
FAA-MSR 420	19, 20		
FLM-420-RHV	29, 30		
TSA 160 NT F ->			
FAA-MSR-420	23, 24		
FLM-420-RHV	33, 34		
TSA 160 NT F-IS ->			
FAA-MSR-420	23, 24		
FLM-420-RHV	33, 34		
TSA 160 NT F-IS/TS ->			
FAA-MSR-420	23, 24		

Bosch Sicherheitssysteme GmbH

Robert-Bosch-Ring 5

85630 Grasbrunn

Germany

www.boschsecurity.com

© Bosch Sicherheitssysteme GmbH, 2023

Building solutions for a better life.

202307120836