

# AVENAR panel series

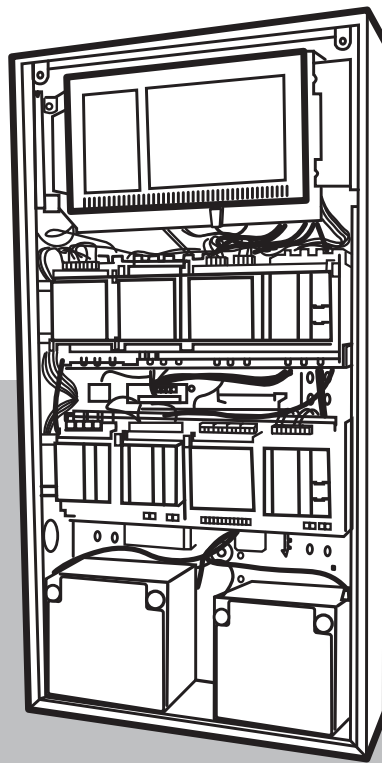





## Sommaro

<b>1</b>	<b>Avvisi</b>	<b>4</b>
1.1	Contenuto	4
1.2	Informazioni sul prodotto	5
1.3	Note importanti	5
1.4	Note per l'utente	5
1.4.1	Simboli capitolo	7
1.4.2	Simboli collegamento	7
1.4.3	Alimentazione e cablaggio	8
1.5	Valori di resistenza	8
<b>2</b>	<b>Wiring</b>	<b>10</b>
2.1	FPP-5000 Power supply	11
2.2	FPP-3000 Power supply (ZSP135-DR-5A-3/ZSP135-OUT6)	13
2.3	DIBT	15
2.4	Functional Modules	42
2.4.1	BCM-000-B	43
2.4.2	CZM 0004 A	45
2.4.3	ENO 0000 A/B	61
2.4.4	LSN 0300 A	68
2.4.5	NZM 0002 A	106
2.4.6	RMH 0002 A	119
2.4.7	IOS 0020 A	120
2.4.8	FPE-5000-UGM	122
2.5	Interface Modules	124
2.5.1	FLM-420-4/CON-D/S	125
2.5.2	FLM-420-I8R1-S	158
2.5.3	FLM-420-NAC-D/S	160
2.5.4	FLM-420-RHV	172
2.5.5	FLM-420-RLE-S	184
2.5.6	FLM-420-RLV1-E	185
2.5.7	FLM-420-RLV8-S	186
2.5.8	FMF-ADP-FBF/FMF-ADP-TTY	187
2.6	EOL	188
2.6.1	CZM 0004 A	189
2.6.2	LSN 0300 A	201
2.6.3	FLM-420/4-CON-S/D	246
		<b>273</b>

# 1 Avvisi

## 1.1 Contenuto

La presente guida al cablaggio illustra in linea di principio le modalità di collegamento dei dispositivi periferici alla centrale antincendio. Le normative nazionali e locali non vengono prese in considerazione. L'applicazione dei requisiti nazionali e locali può comportare ulteriori collegamenti.

**Avviso!**

I collegamenti descritti in questo documento sono validi anche per la AVENAR panel 2000, a condizione che i singoli componenti siano estensioni approvate da Bosch Sicherheitssysteme GmbH della AVENAR panel 2000.

**Avviso!**

I collegamenti LSN 0300 A riportati nel presente documento si applicano anche al modulo LSN 1500 A.

Per quanto riguarda il modulo LSN 1500 A, tenere presente che per le installazioni in Germania, dove è richiesta la conformità a VdS 2540, la linea AUX e la linea LSN devono essere in cavi separati.

## 1.2 Informazioni sul prodotto

- Le istruzioni di installazione per i singoli componenti della centrale FACP sono riportate nel manuale di installazione in dotazione.
- Ulteriori informazioni (manuali utente, guida al collegamento in rete, manuale di sistema) sono disponibili su Internet all'indirizzo: [www.boschsecurity.com](http://www.boschsecurity.com)

## 1.3 Note importanti

- Utilizzare solo i materiali necessari all'installazione consigliati da Bosch Security Systems.
- Indossare sempre un cinturino con messa a terra quando si effettuano modifiche e lavori di saldatura.
- L'assemblaggio e l'installazione devono essere eseguiti solo da personale qualificato.
- Osservare i criteri di collegamento stabiliti dalle normative locali vigenti.



### Pericolo!

Il contatto con componenti scoperti potrebbe avere conseguenze letali.  
Prima di eseguire l'installazione, scollegare l'alimentazione.

### Cavo schermato

Per tutti i collegamenti a due fili a CZM 0004 A e per il collegamento dei seguenti prodotti è necessario un cavo schermato:

- FBF 100 LSN
- FMF-ADP, FMF-FAT, FMF-FBF-FAT, FMF-FIBS-A4, FMF-FIBS-A3

Il cablaggio di esempio seguente mostra come applicare un cavo schermato.

### Avviso!

Se è necessario collegare un cavo schermato per il cavo LSN, procedere secondo le specifiche LSN.

- Collegare il filo schermato LSN sul lato della centrale al connettore di messa a terra funzionale designato:

due connessioni all'inizio e alla fine di un loop  
una connessione all'inizio di una linea aperta

- Eseguire il loop-through del filo schermato su tutte le periferiche LSN mediante i terminali forniti

- Non sono consentite connessioni aggiuntive del filo schermato LSN, né ai connettori di messa a terra in qualsiasi posizione, né ad altri potenziali elettrici



## 1.4 Note per l'utente

La Guida di cablaggio presenta la struttura seguente:

- Il capitolo Cablaggio è organizzato in base al dispositivo al quale è collegata la periferica. Un cablaggio mostra il collegamento diretto di un dispositivo a un altro dispositivo (senza collegamenti a cascata).
- Una raccolta di tutti i cablaggi arricchiti con moduli EOL aggiuntivi per il monitoraggio delle interruzioni di circuito lente si trova nella sezione EOL.

Per trovare il cablaggio necessario, utilizzare anche:

- il sommario all'inizio del capitolo Cablaggio e all'inizio delle sezioni Moduli funzionali, Moduli interfaccia e EOL.
- l'Index (non ordinato per lingua),
- e la ricerca di testo completo.

Vedere il seguente cablaggio esemplificativo:

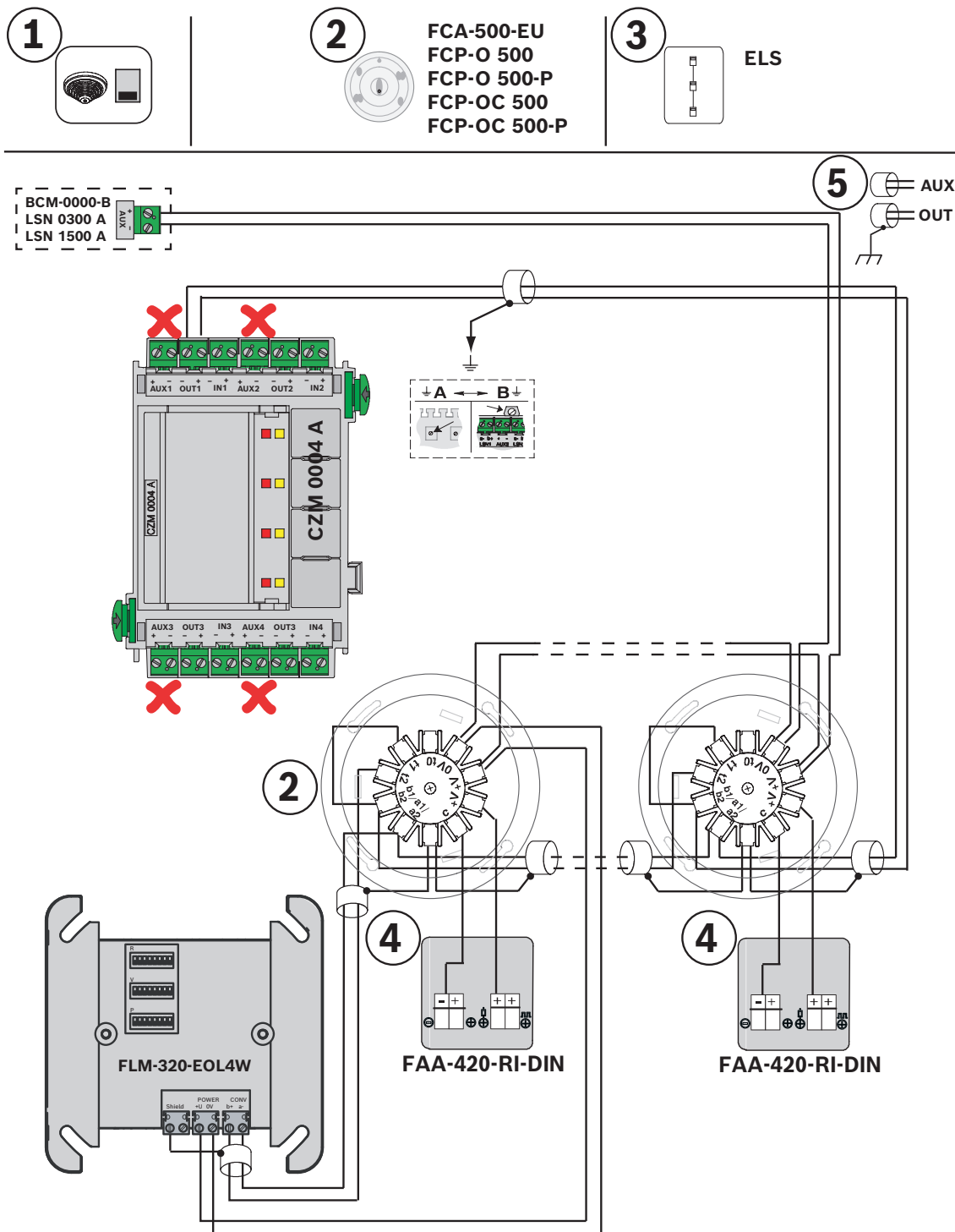

















1	Simboli capitolo ( <i>Simboli capitolo, pagina 7</i> )
2	Dispositivo periferico collegabile
3	Simboli collegamento ( <i>Simboli collegamento, pagina 7</i> )
4	Componenti opzionali
5	Alimentazione e cablaggio ( <i>Alimentazione e cablaggio, pagina 8</i> )

### 1.4.1 Simboli capitolo



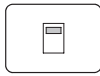
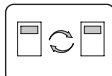

	Rivelatori automatici		Pannelli operativi e display		Stampante
	Alimentazione		Moduli funzionali		Dispositivi per il servizio antincendio
	Moduli interfaccia		Sistemi di spegnimento		Pulsanti manuali
	Dispositivi di segnalazione		Controlli porte		Unità di trasmissione

### 1.4.2 Simboli collegamento

	Cablaggio obbligatorio		Cablaggio opzionale		Non consentito
	Ridondanza		Cablaggio in loop		Cablaggio in loop con elemento ridondante
	Cablaggio in linea aperta		Cablaggio in linea aperta ridondante		Cablaggio in linea aperta con elemento ridondante
	Cablaggio in linea aperta ridondante con elemento ridondante	ELS	<p>Questo cablaggio è conforme allo standard VdS 2489 / VdS 2540 / VdS 2541 / VdS 2543. ELS sta per supervisione di linea estesa (Extended Line Supervision), che significa monitoraggio dei cortocircuiti e delle interruzioni di circuito lenti. Il cablaggio presenta ELS.</p> <p>Un cortocircuito lento viene rilevato dai seguenti moduli: LSN 0300 A, LSN 1500 A e BCM-0000-B con utilizzo di FPP-5000-TI13.</p>		Questo cablaggio in loop è conforme allo standard VdS 2489 / VdS 2540 / VdS 2541 / VdS 2543. Offre la funzione ELS. Non sono necessari moduli EOL aggiuntivi.
	Sincronizzazione		Aree con pericolo di esplosione		Centrale

	Centrale autonoma		Centrale autonoma con ridondanza		Per le basi del rivelatore: il cablaggio è valido unicamente per la base del rivelatore in cui quest'ultimo è installato.
EN 54-2, DIBT ecc.	Per assicurare la conformità a questo standard, utilizzare il cablaggio specificato.				

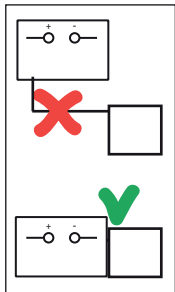
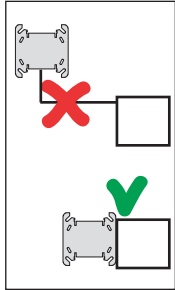
### 1.4.3 Alimentazione e cablaggio

	È necessario un cavo a 2 fili.
	È necessario un cavo schermato a 2 fili.
	L'alloggiamento del prodotto contenente l'alimentatore deve essere montato ad incasso con l'elemento.
	Per il modulo interfaccia è necessario il montaggio ad incasso.
 <b>Reset action</b>	Consultare il cablaggio nel presente manuale. Per fornire il ripristino automatico del dispositivo è necessario implementare l'azione di ripristino.

## 1.5 Valori di resistenza

La seguente tabella mostra una panoramica delle codifiche dei colori per le resistenze. Le resistenze della pellicola di metallo fornite con il prodotto presentano 5 bande colorate che ne indicano il valore.

Colore	1. banda	2. banda	3. banda	4. banda (moltiplicatore)	5. banda (tolleranza)
Argento				$10^{-2}$	$\pm 10\%$
Oro				$10^{-1}$	$\pm 5\%$
Nero		0	0	$10^0$	
Marrone	1	1	1	$10^1$	$\pm 1\%$

<b>Colore</b>	<b>1. banda</b>	<b>2. banda</b>	<b>3. banda</b>	<b>4. banda (moltiplicatore)</b>	<b>5. banda (tolleranza)</b>
Rosso	2	2	2	10 <sup>2</sup>	±2%
Arancione	3	3	3	10 <sup>3</sup>	±0.05%
Giallo	4	4	4	10 <sup>4</sup>	±0.02%
Verde	5	5	5	10 <sup>5</sup>	±0.5%
Blu	6	6	6	10 <sup>6</sup>	±0.25%
Viola	7	7	7	10 <sup>7</sup>	±0.1%
Grigio	8	8	8	10 <sup>8</sup>	±0.01%
Bianco	9	9	9	10 <sup>9</sup>	

Conforme a DIN EN 60062:2017

*Arancione - Bianco - Nero - Marrone - Marrone:* resistenza di 3.900 Ohm con tolleranza dell'1%

*Rosso - Rosso - Nero - Marrone - Marrone:* resistenza di 2.200 Ohm con tolleranza dell'1%

## 2 Wiring



*FPP-5000 Power supply, pagina 11*

*FPP-3000 Power supply (ZSP135-DR-5A-3/ZSP135-OUT6), pagina 13*

*DIBT, pagina 15*

*Functional Modules, pagina 42*

*BCM-000-B, pagina 43*

*CZM 0004 A, pagina 45*

*ENO 0000 A/B, pagina 61*

*LSN 0300 A, pagina 68*

*NZM 0002 A, pagina 106*

*RMH 0002 A, pagina 119*

*IOS 0020 A, pagina 120*

*FPE-5000-UGM, pagina 122*

*Interface Modules, pagina 124*

*FLM-420-4/CON-D/S, pagina 125*

*FLM-420-I8R1-S, pagina 158*

*FLM-420-NAC-D/S, pagina 160*

*FLM-420-RHV, pagina 172*

*FLM-420-RLE-S, pagina 184*

*FLM-420-RLV1-E, pagina 185*

*FLM-420-RLV8-S, pagina 186*

*FMF-ADP-FBF/FMF-ADP-TTY, pagina 187*

*EOL, pagina 188*

*CZM 0004 A, pagina 189*

*LSN 0300 A, pagina 201*

*FLM-420/4-CON-S/D, pagina 246*



## 2.1 FPP-5000 Power supply

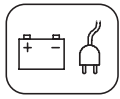

FPP-5000-TI

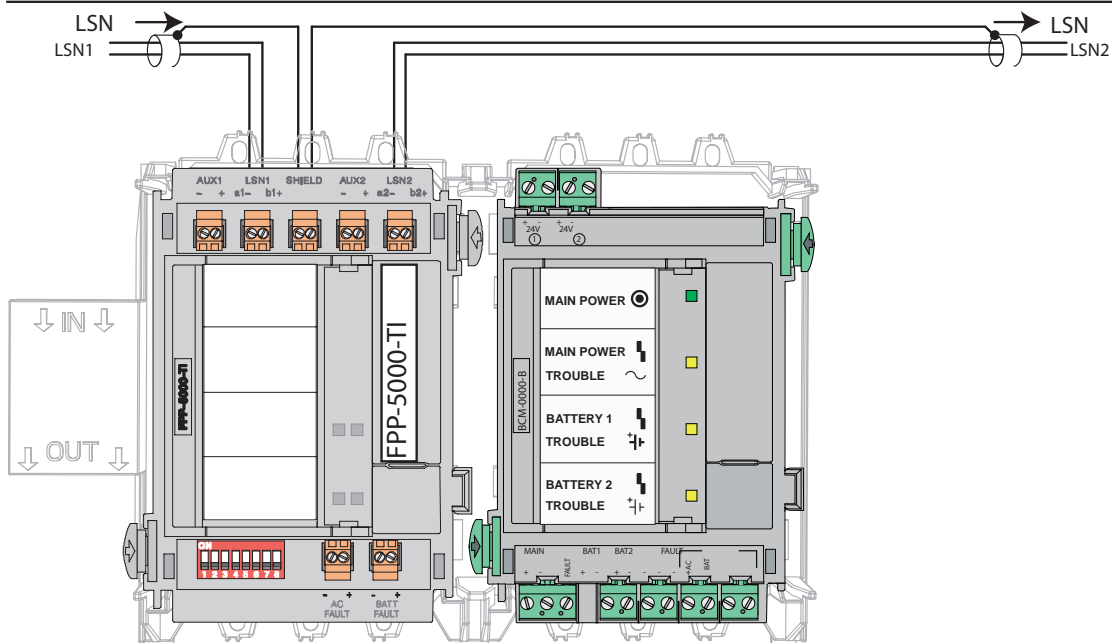

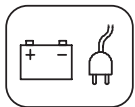

FPP-5000-TI13

ELS

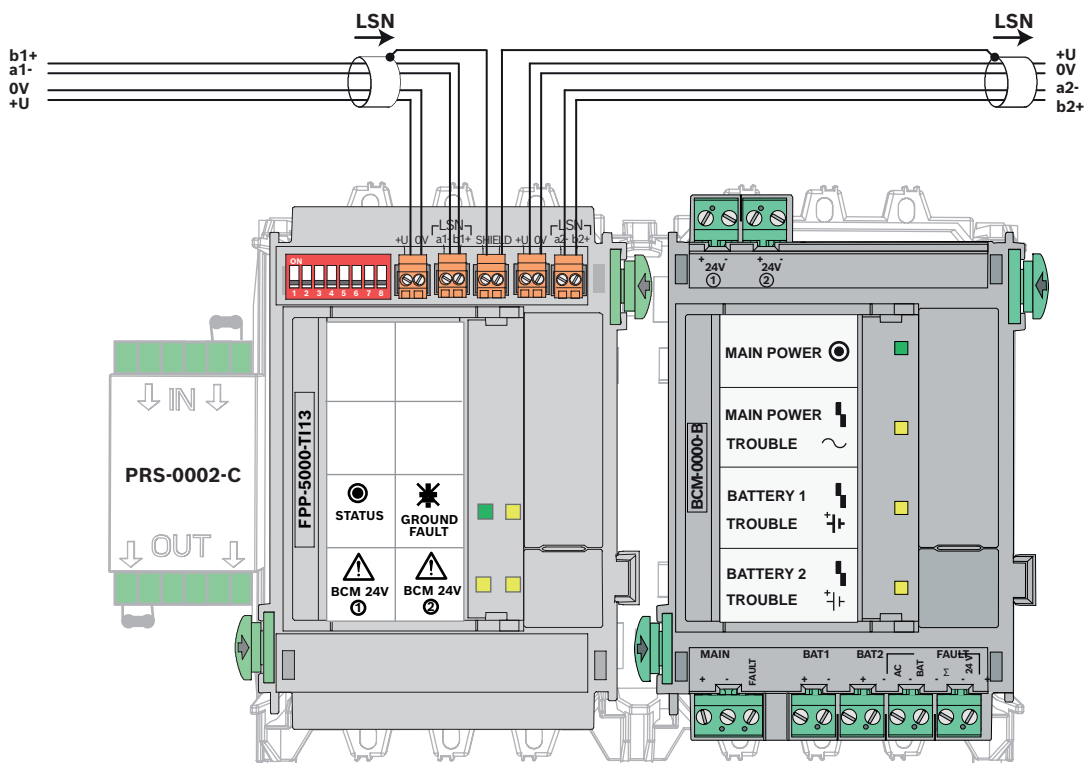

## 2.2 FPP-3000 Power supply (ZSP135-DR-5A-3/ZSP135-OUT6)

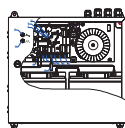
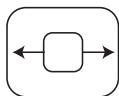

ZSP135-DR-5A-3  
ZSP135-OUT6  
FPP-3000

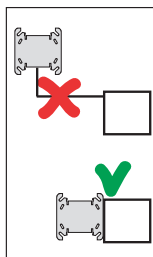
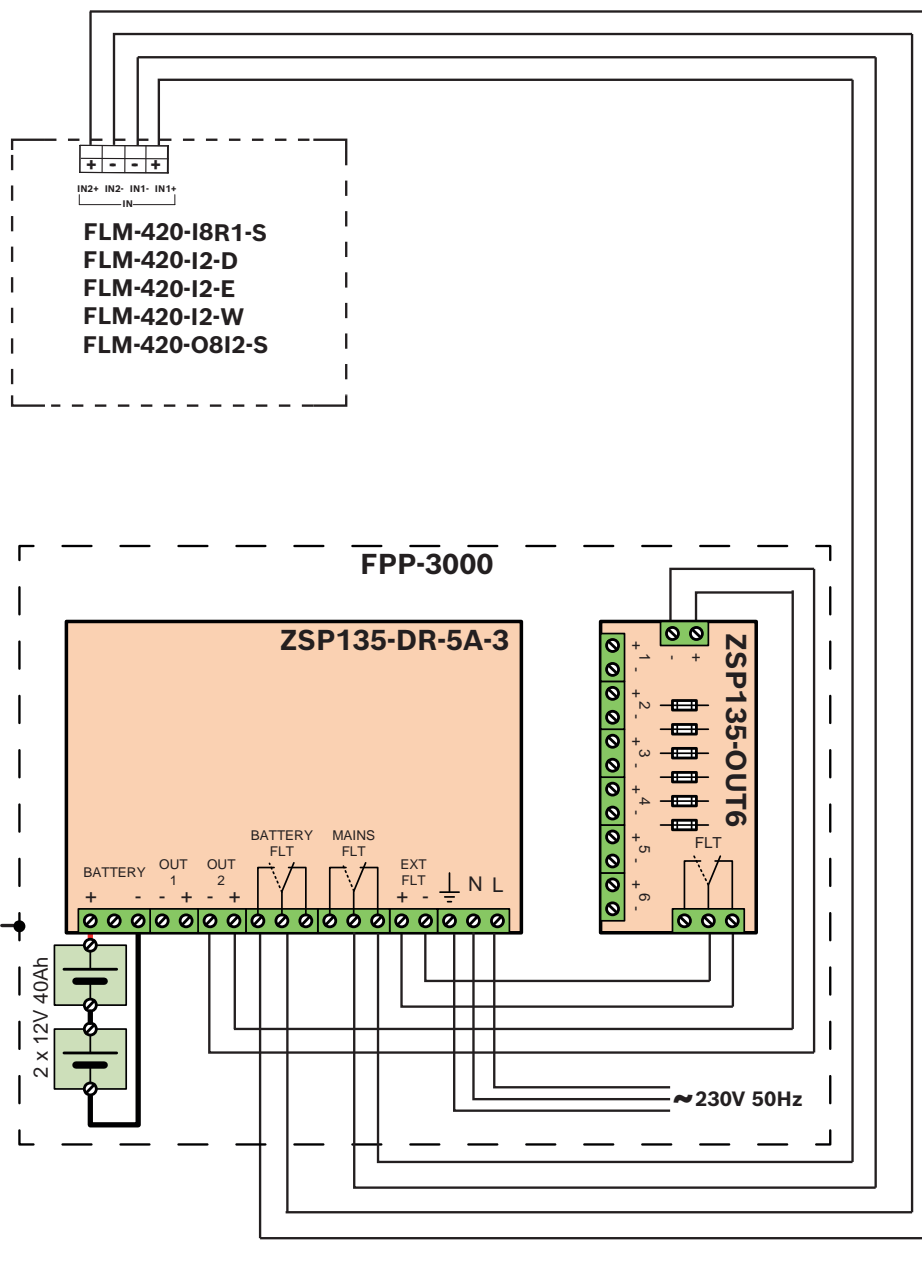

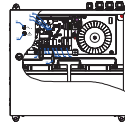
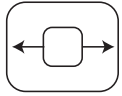

ZSP135-DR-5A-3  
ZSP135-OUT6  
FPP-3000

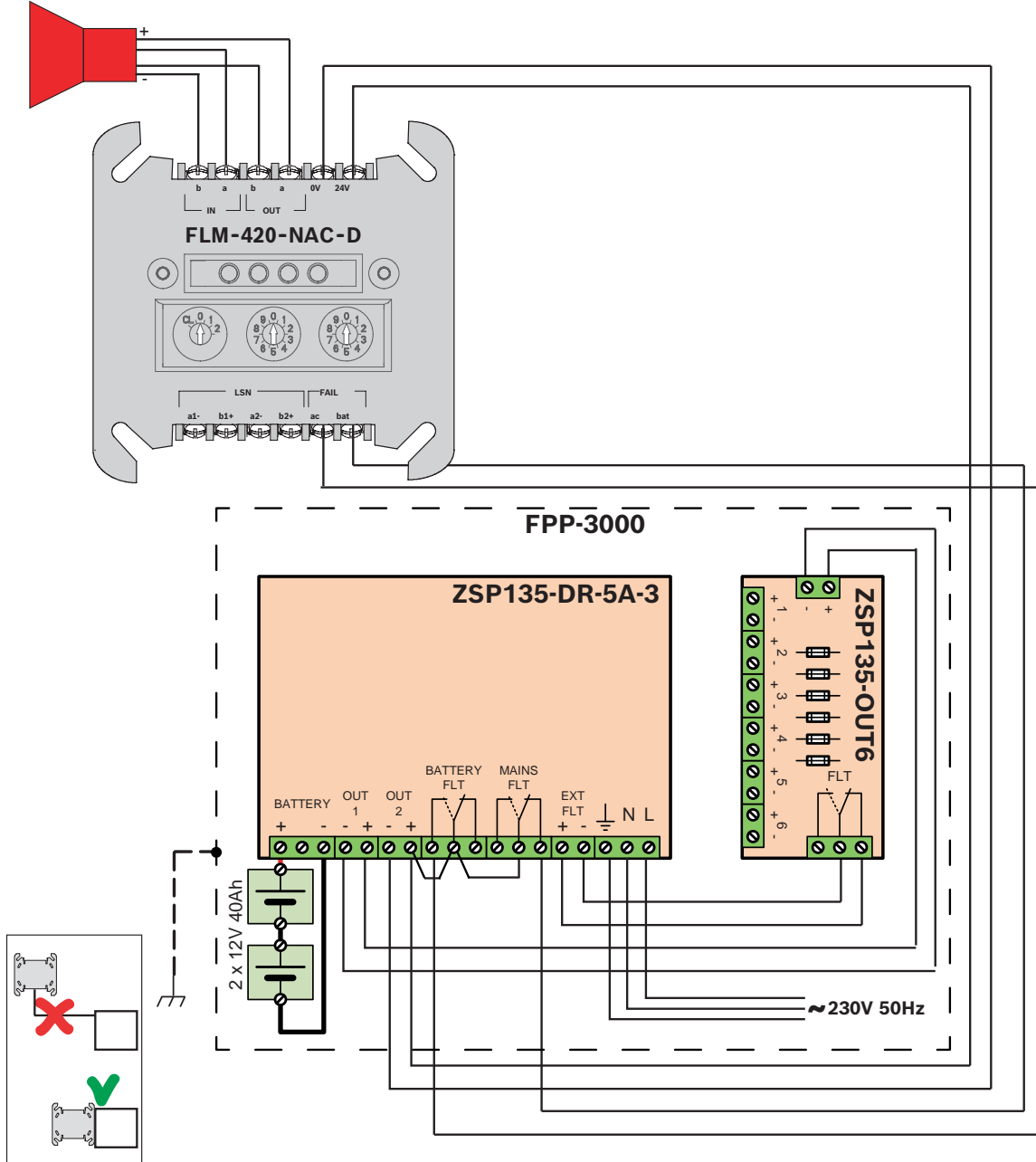

### 2.3 DIBT

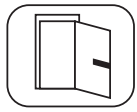

**ED 100  
ED 250  
(+Upgrade Card B)**

**DIBT**

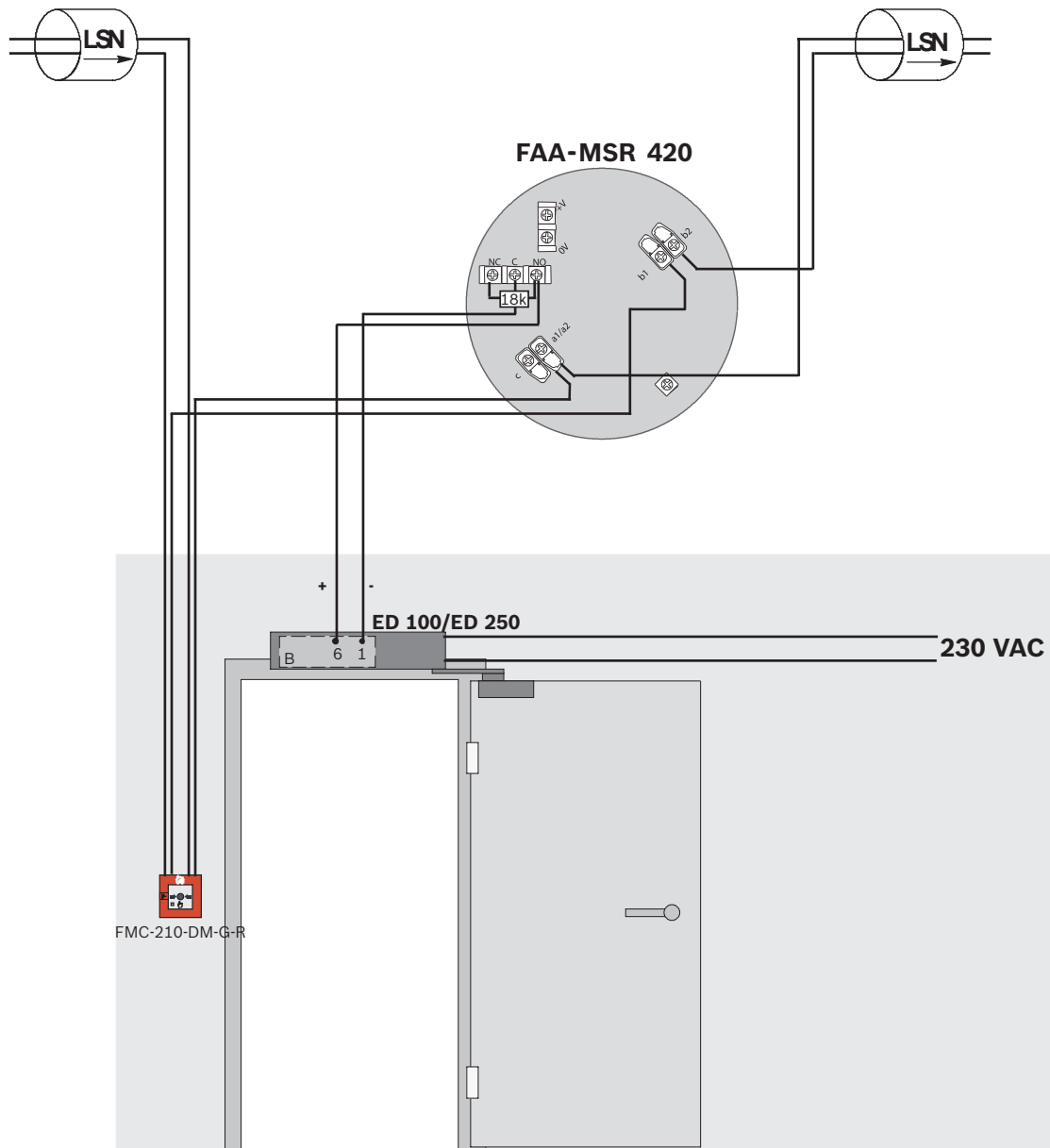



**ED 100  
ED 250  
(+Upgrade Card B)**

**DIBT**

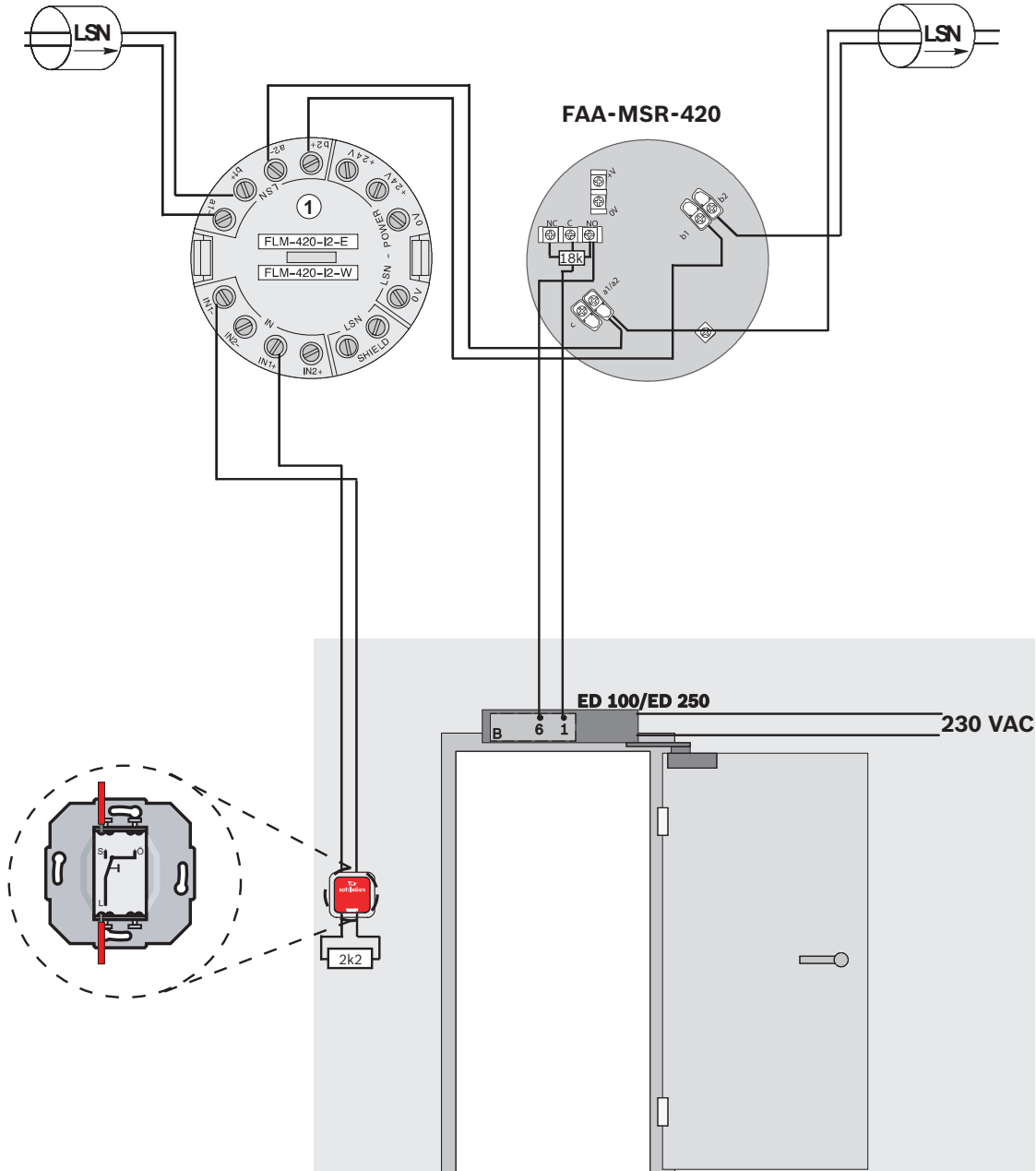

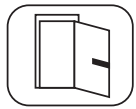

DIBT

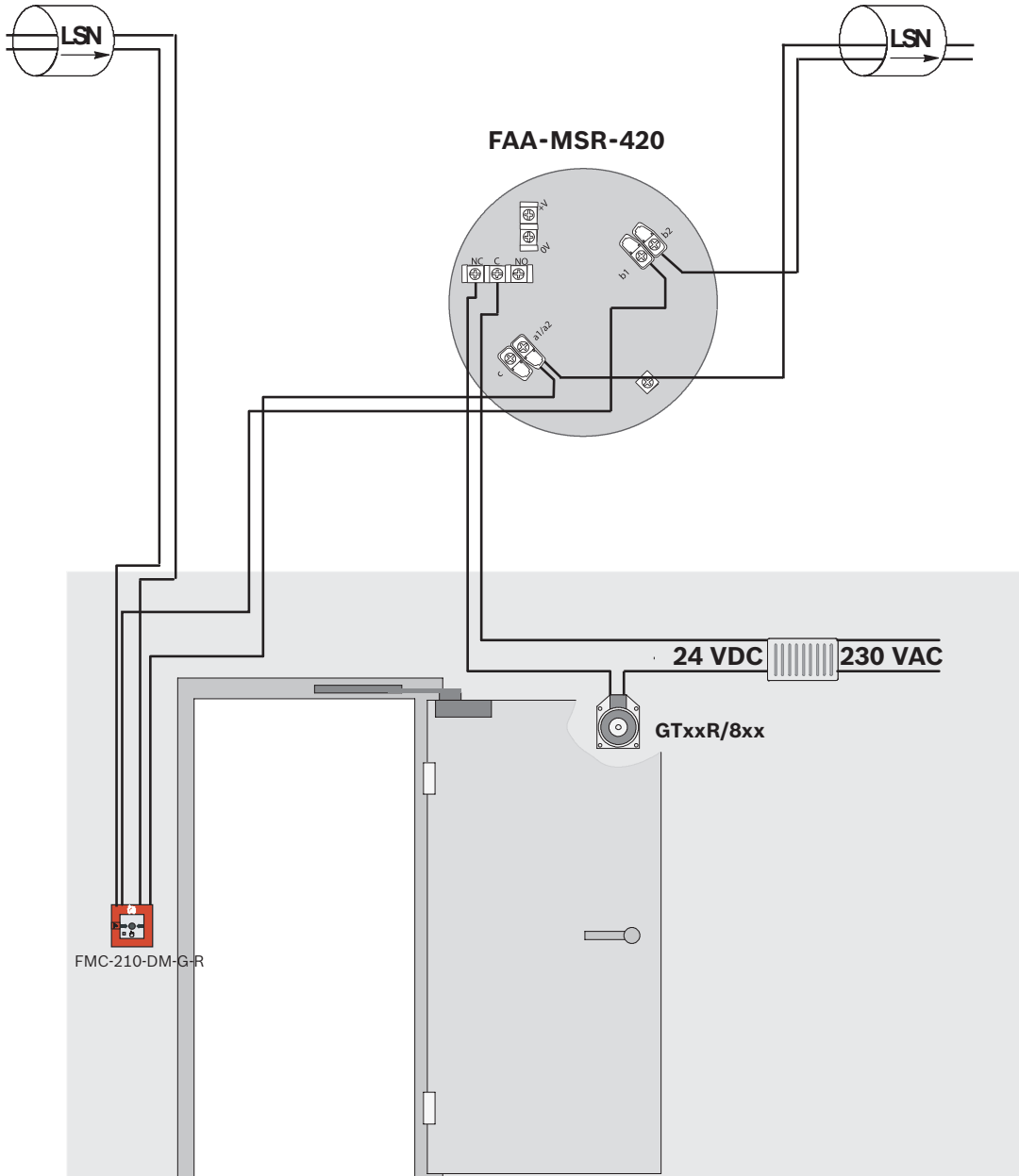

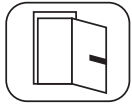

DIBT

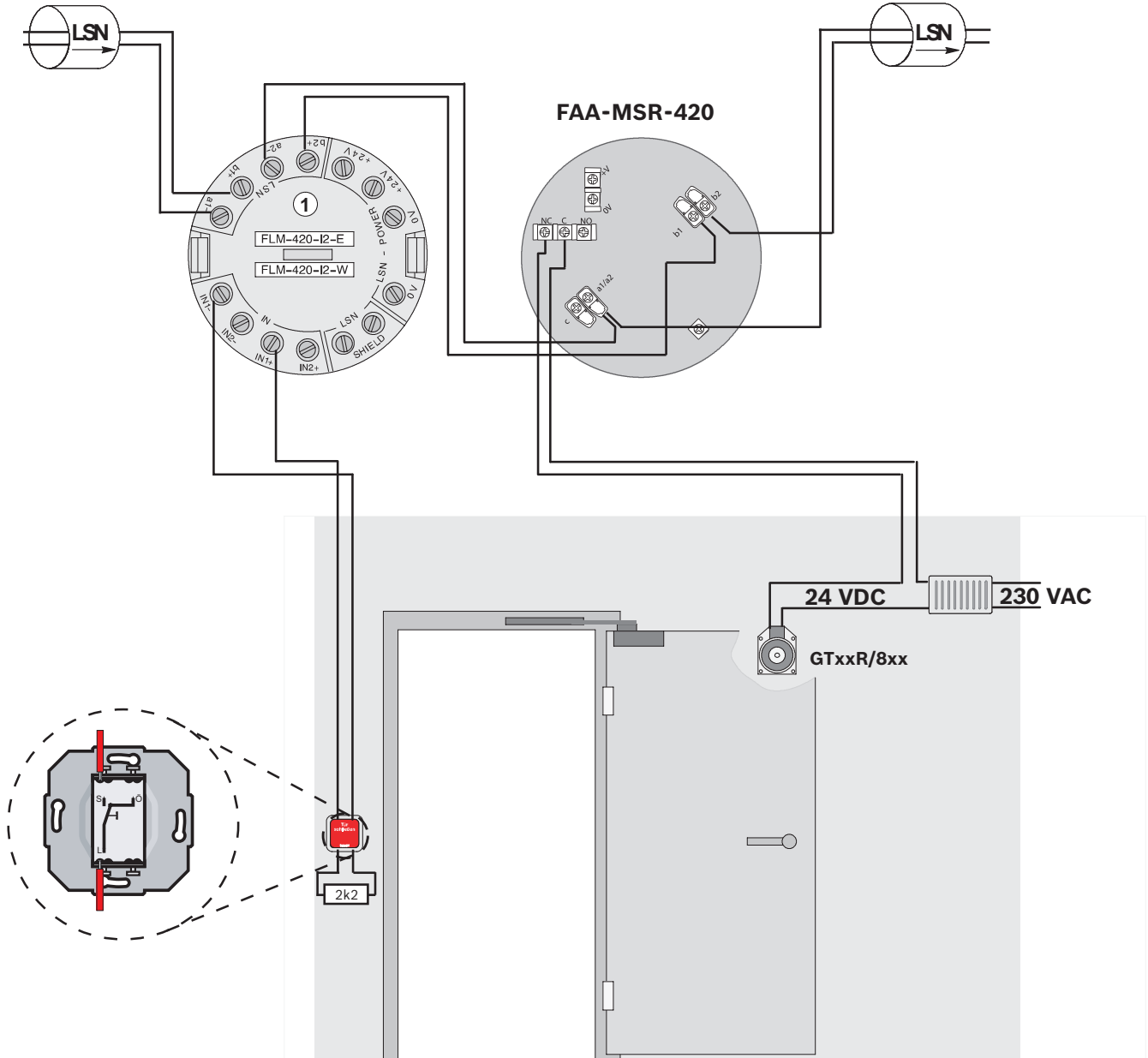



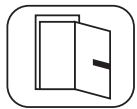

TS 73 EMF  
 TS 93 EMF  
 TS 93 GSR  
 BTS 80 EMB  
 BTS 80 FLB

**DIBT**

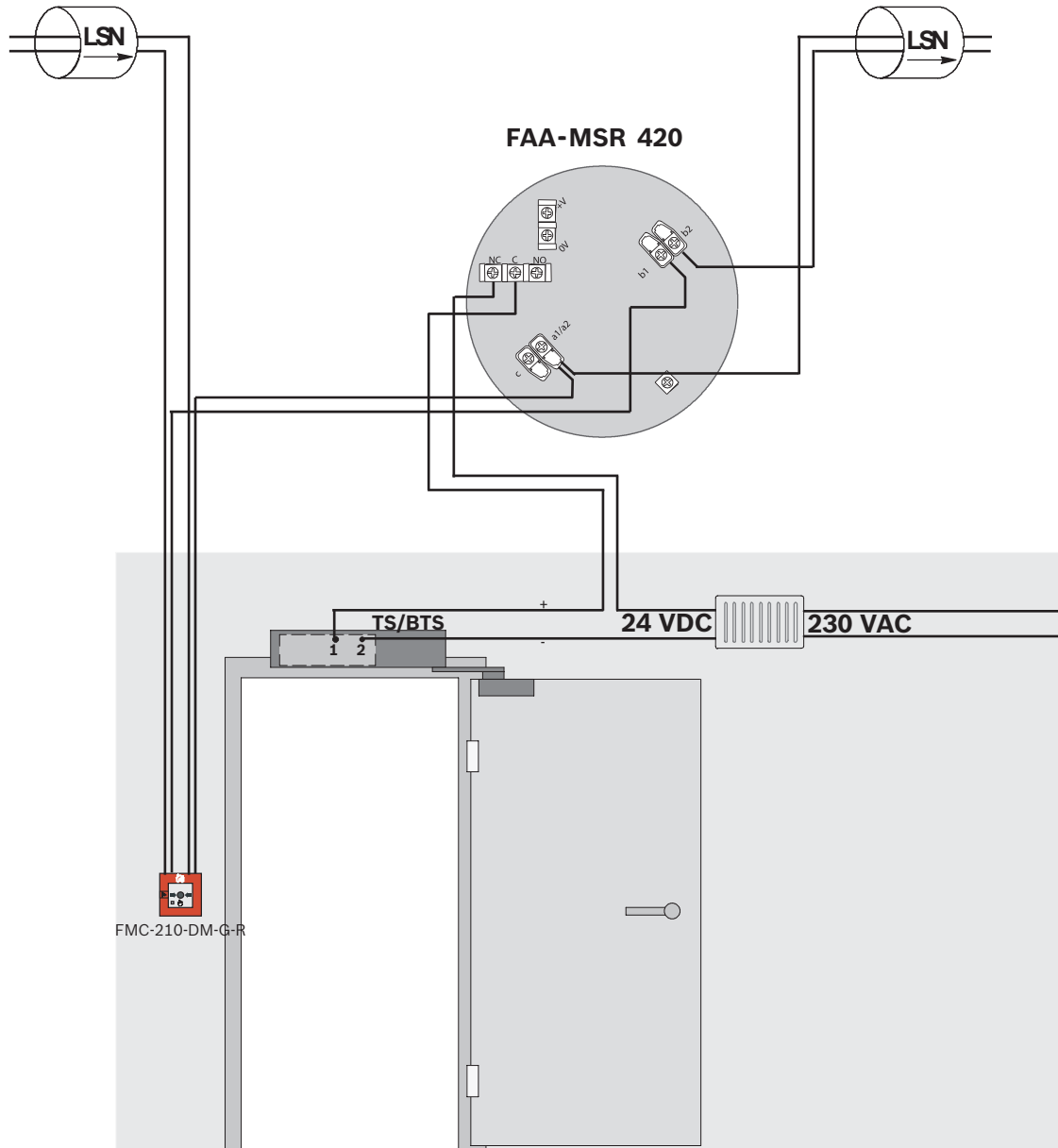



TS 73 EMF  
 TS 93 EMF  
 TS 93 GSR  
 BTS 80 EMB  
 BTS 80 FLB

DIBT

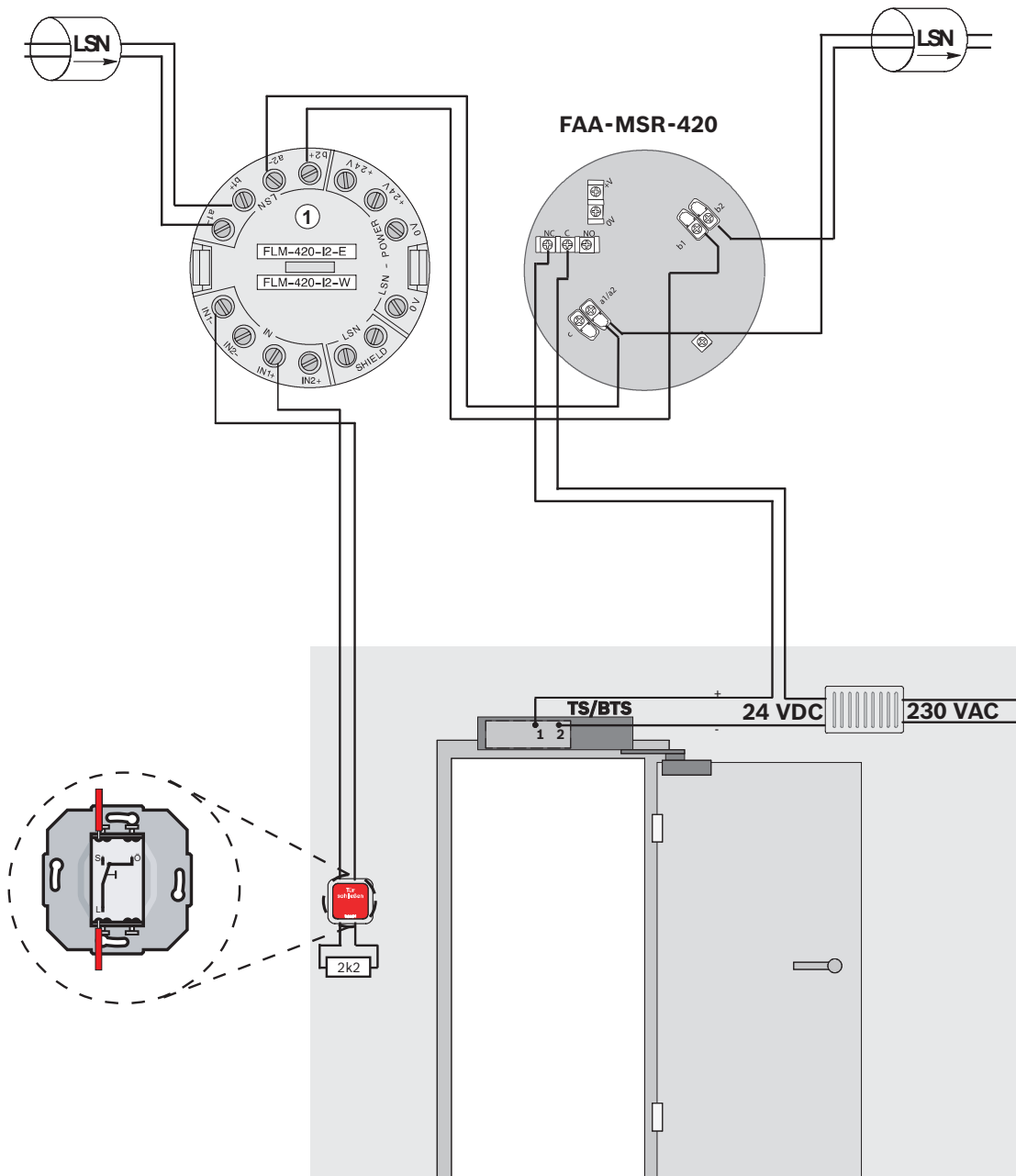

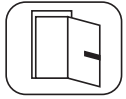

Slimdrive EMD-F/EMD F-IS

DIBT

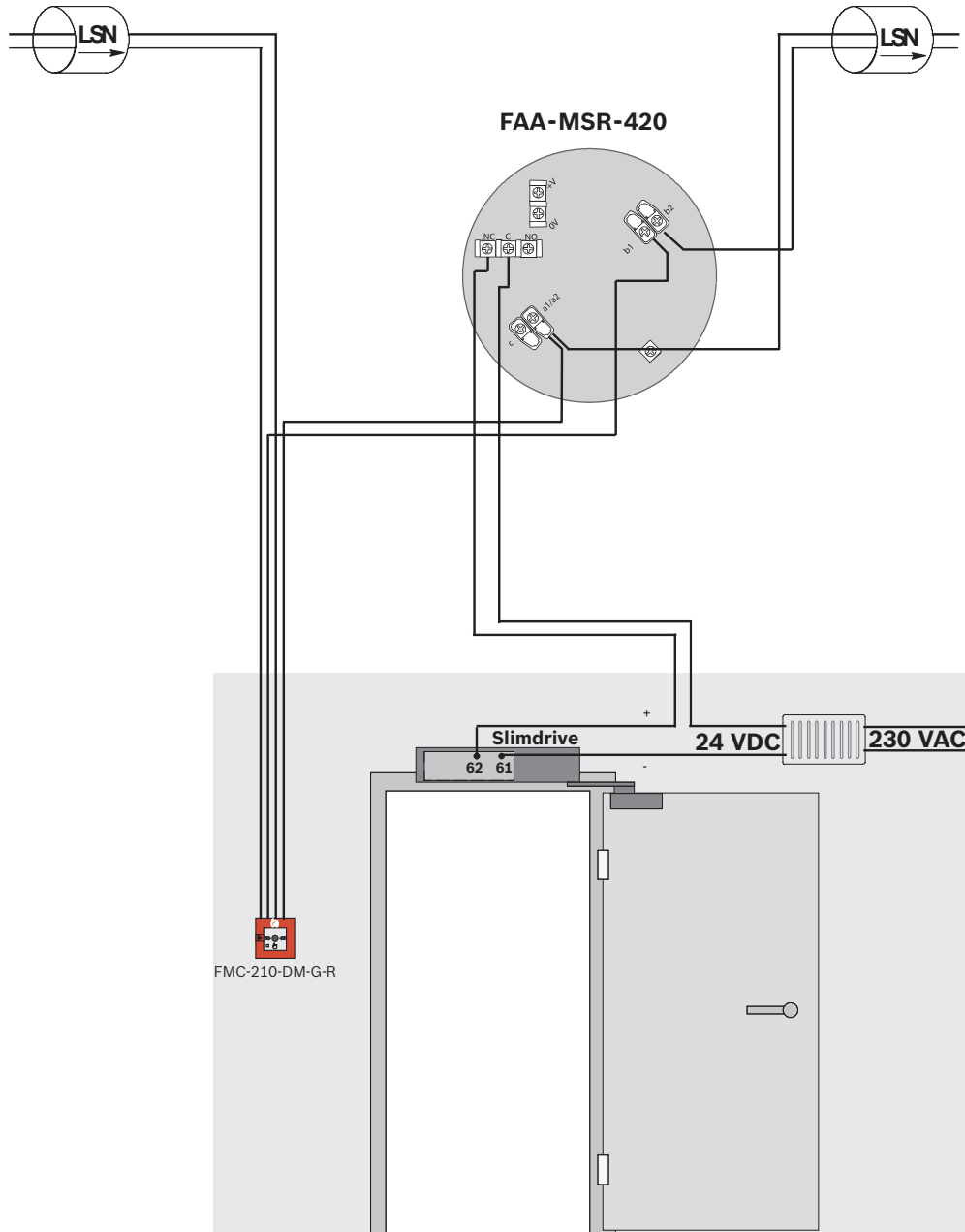



Slimdrive EMD-F/EMD F-IS

DIBT

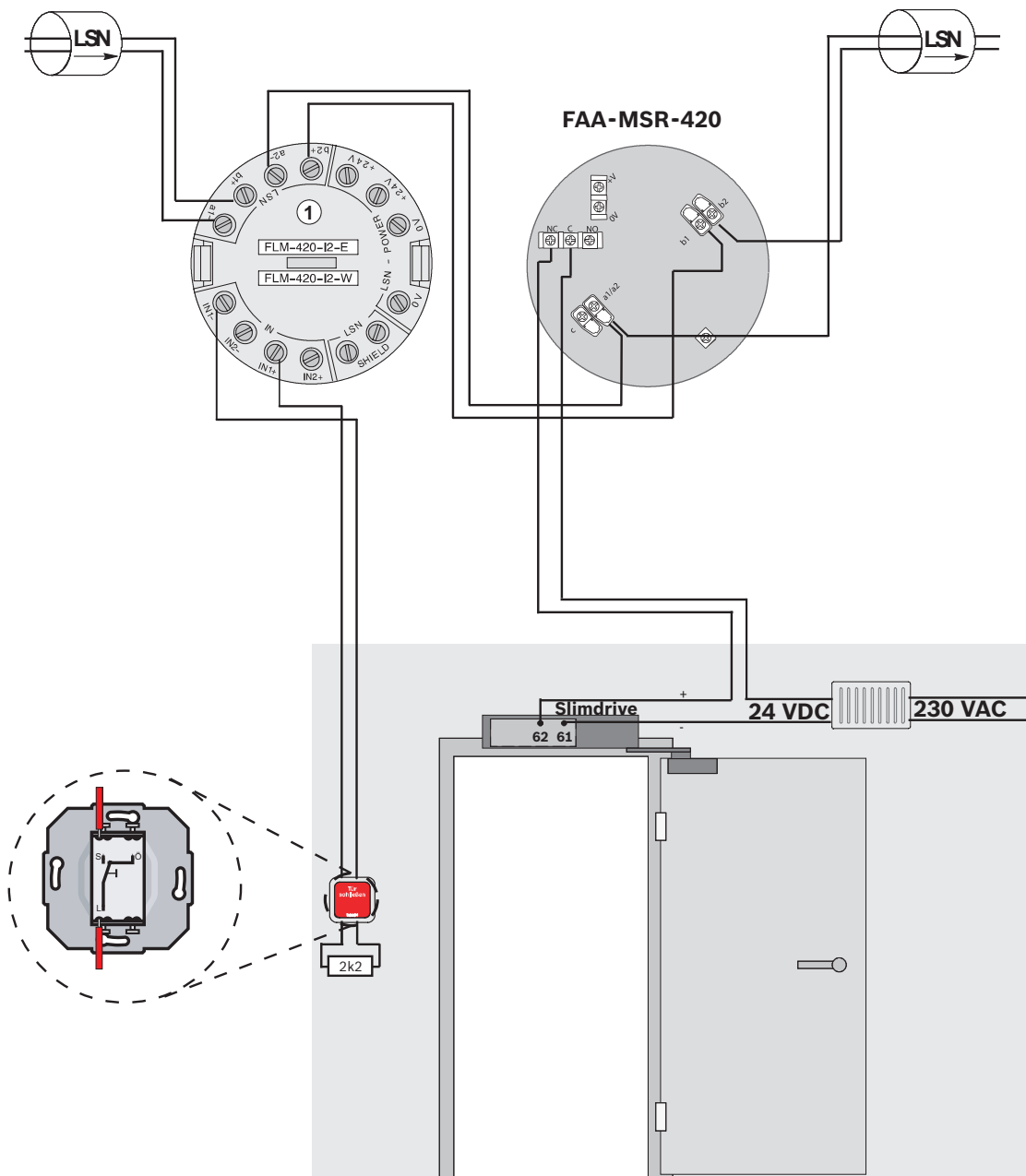

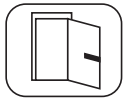

TS 4000 E/E-IS/EFS  
 TS 5000 E/E-IS/E-ISM  
 TS 550 E  
 TSA 160 NT F/F-IS/F-IS/TS

DIBT

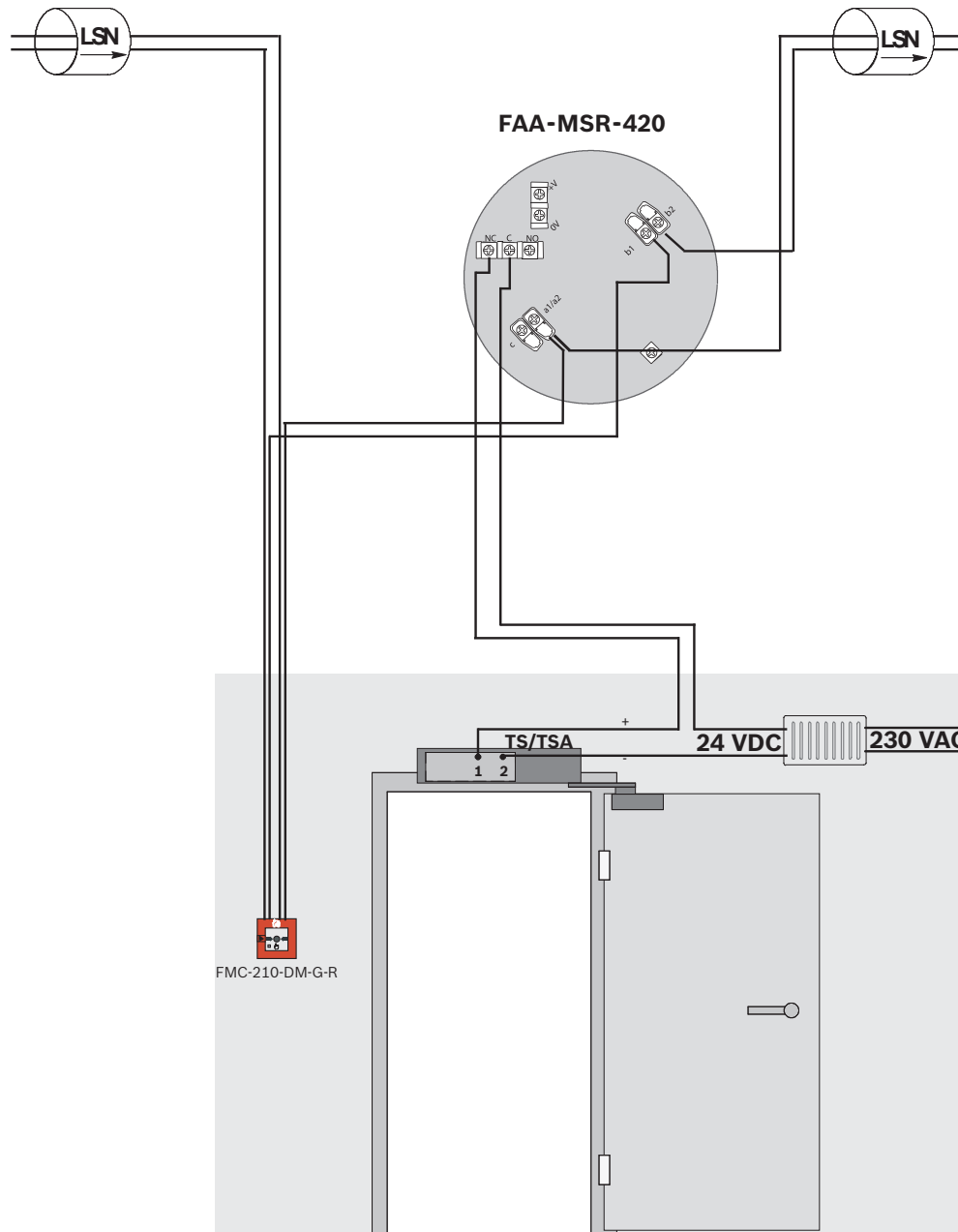

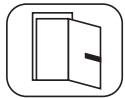

TS 4000 E/E-IS/EFS  
 TS 5000 E/E-IS/E-ISM  
 TS 550 E  
 TSA 160 NT F/F-IS/F-IS/TS

DIBT

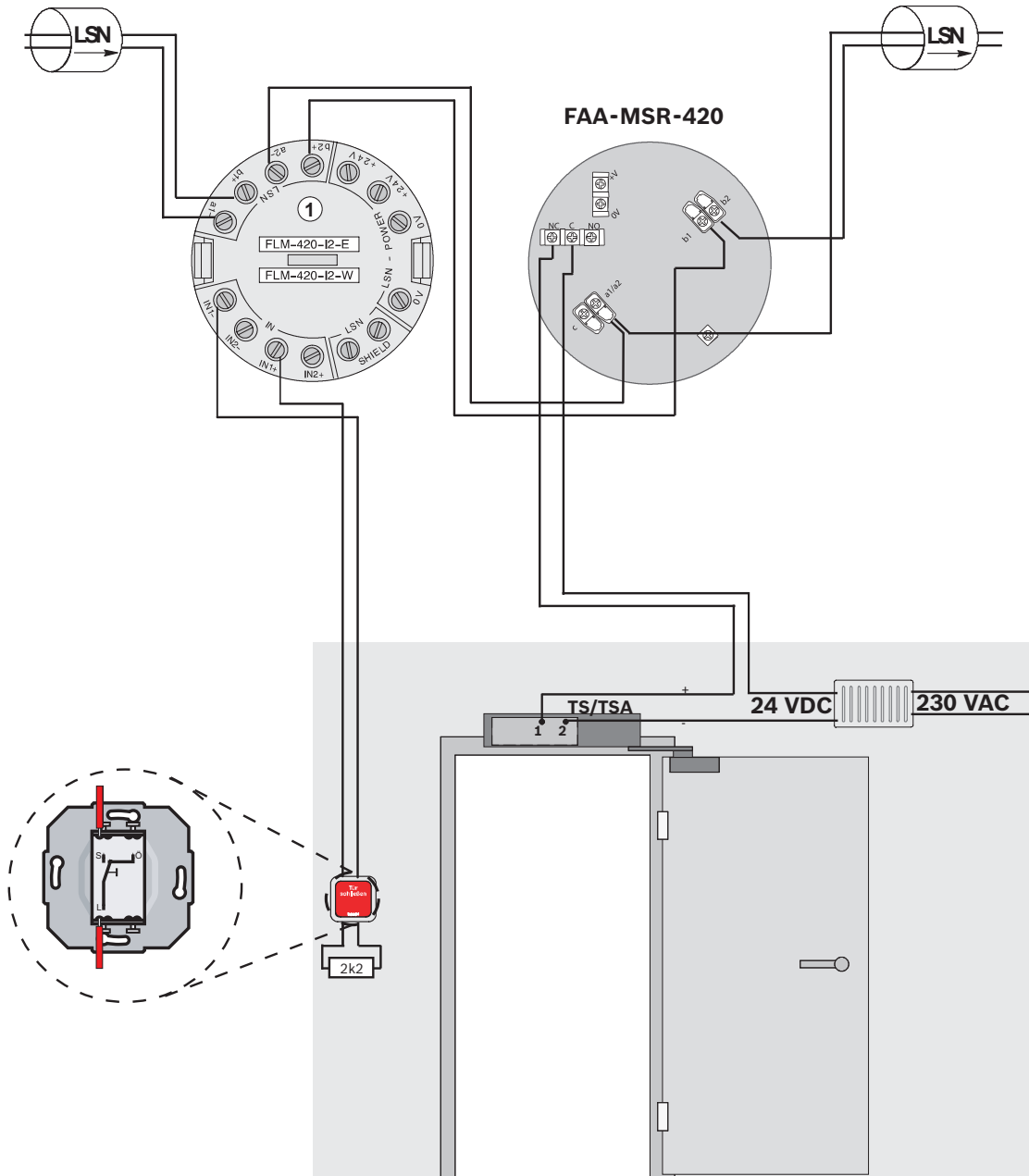

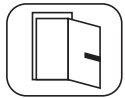

**ED 100  
ED 250  
(+Upgrade Card B**

**DIBT**

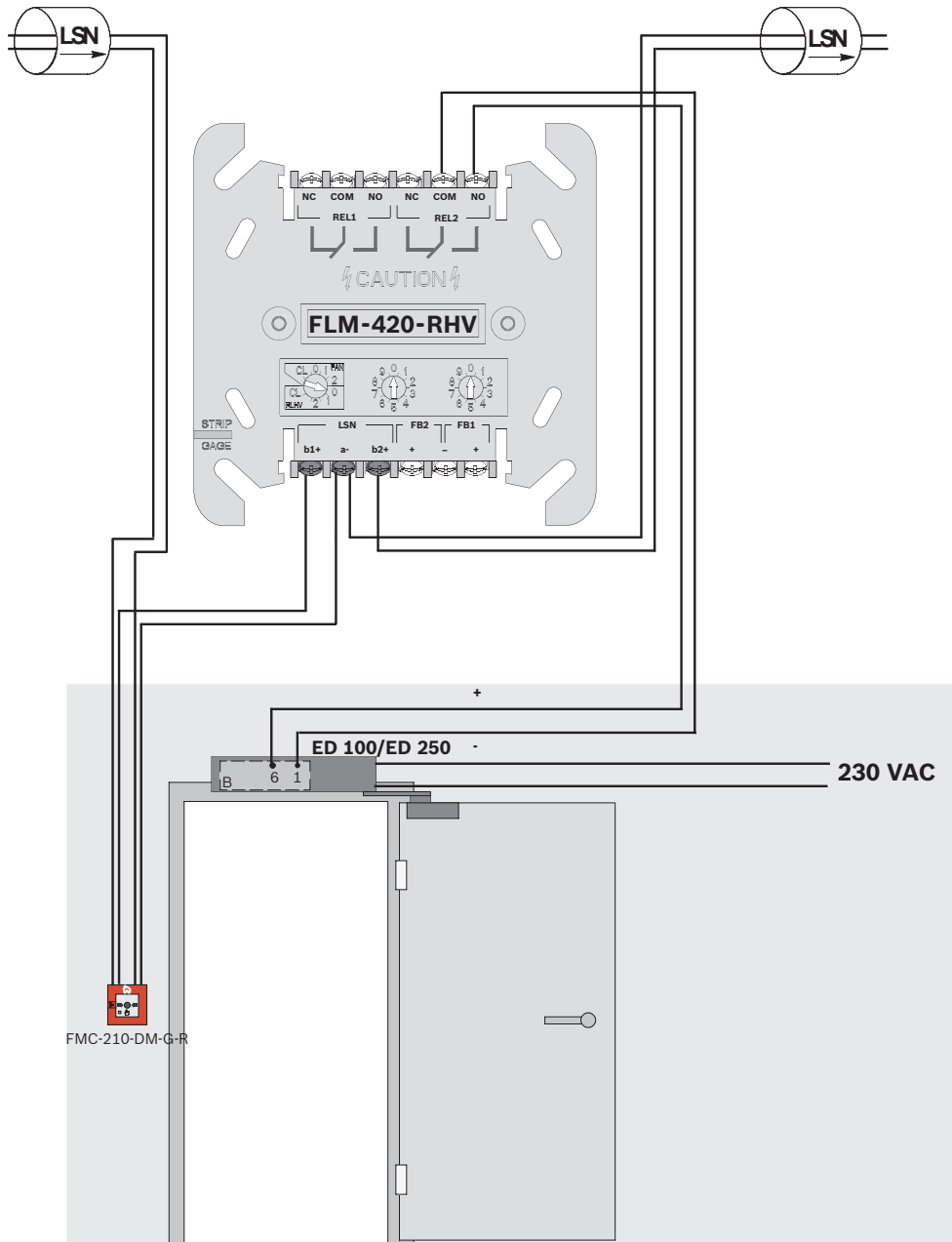



**ED 100  
ED 250  
(+Upgrade Card B)**

**DIBT**

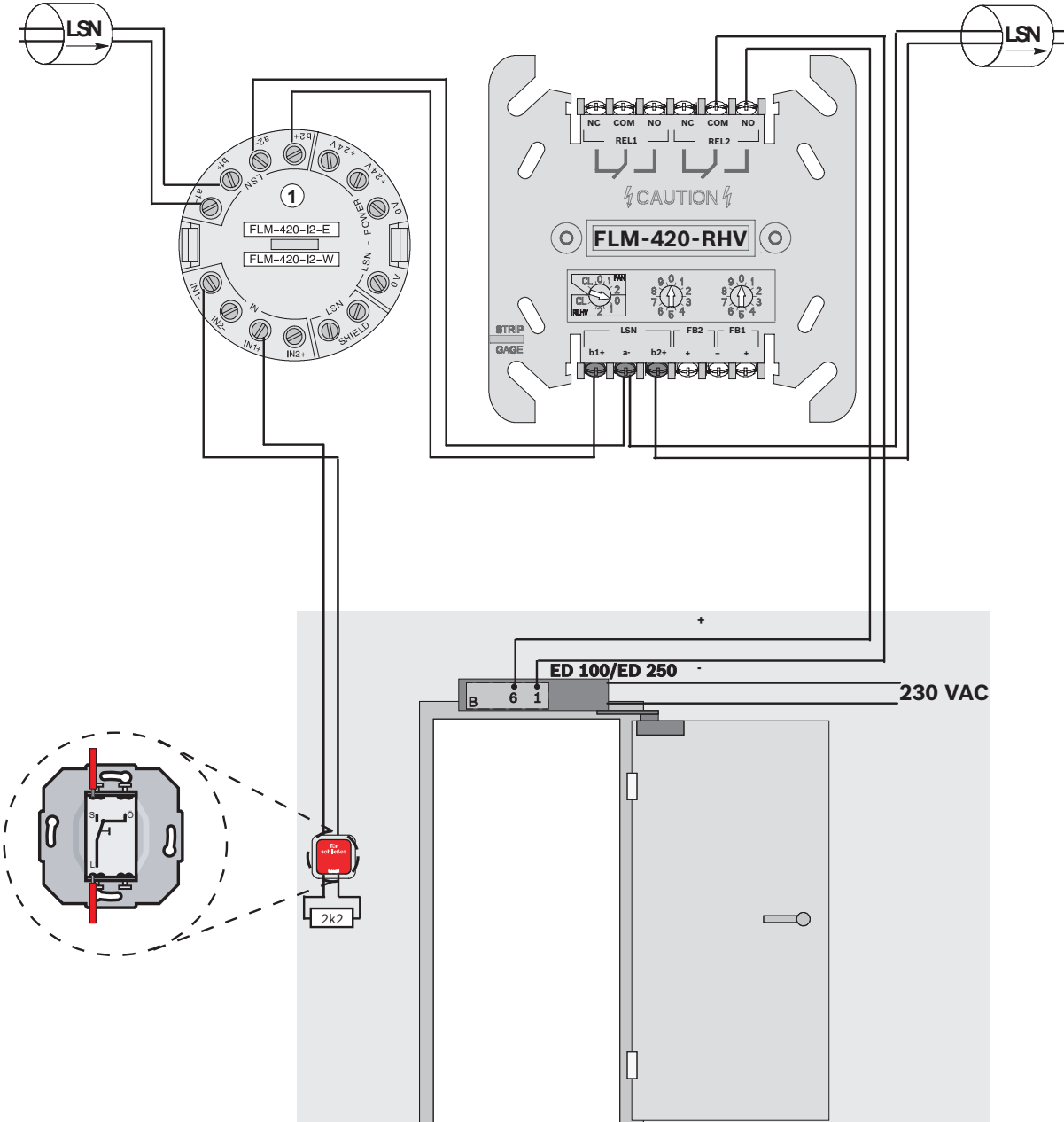



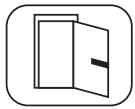

DIBT

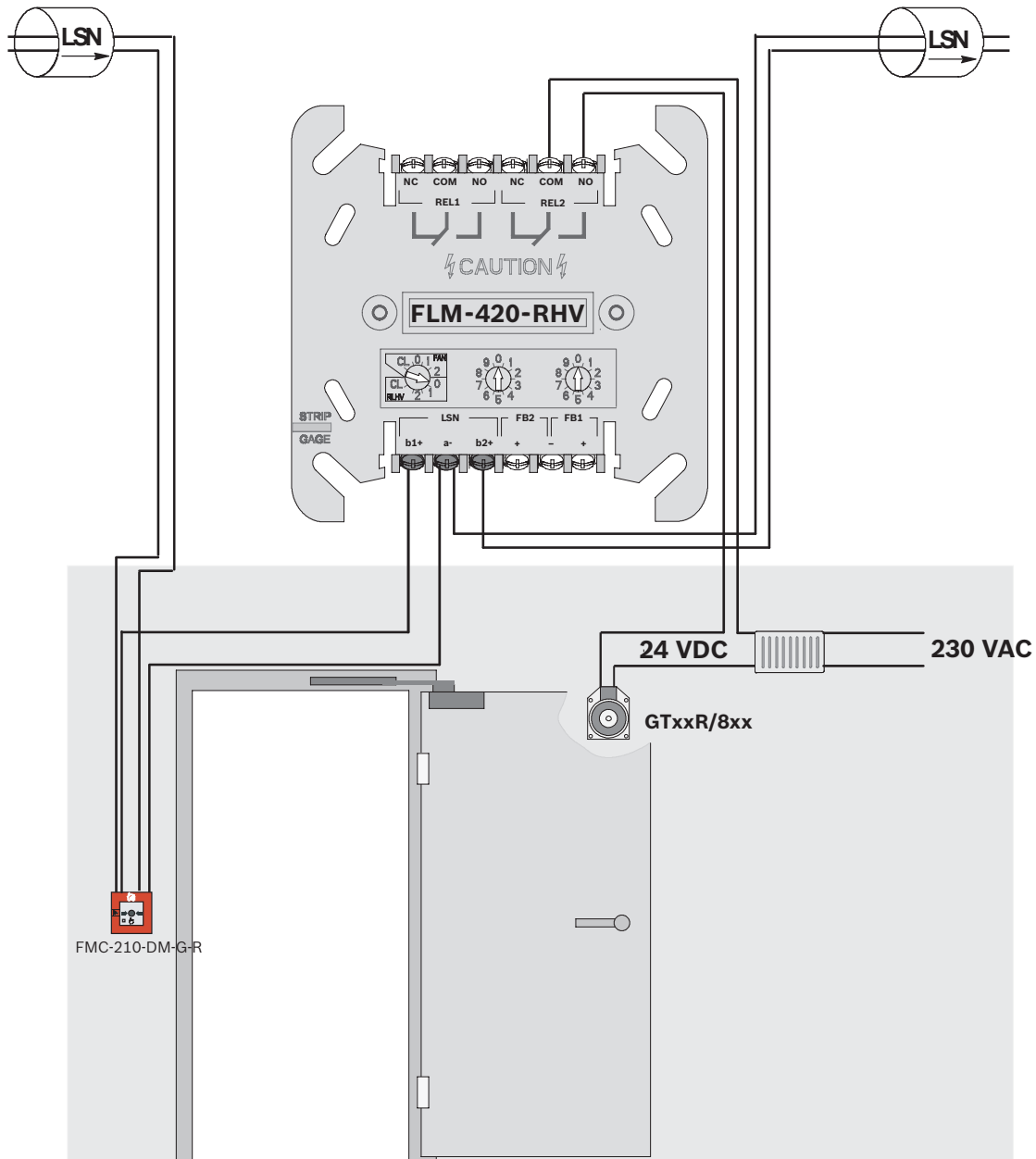



GT xx R

8 xx

DIBT

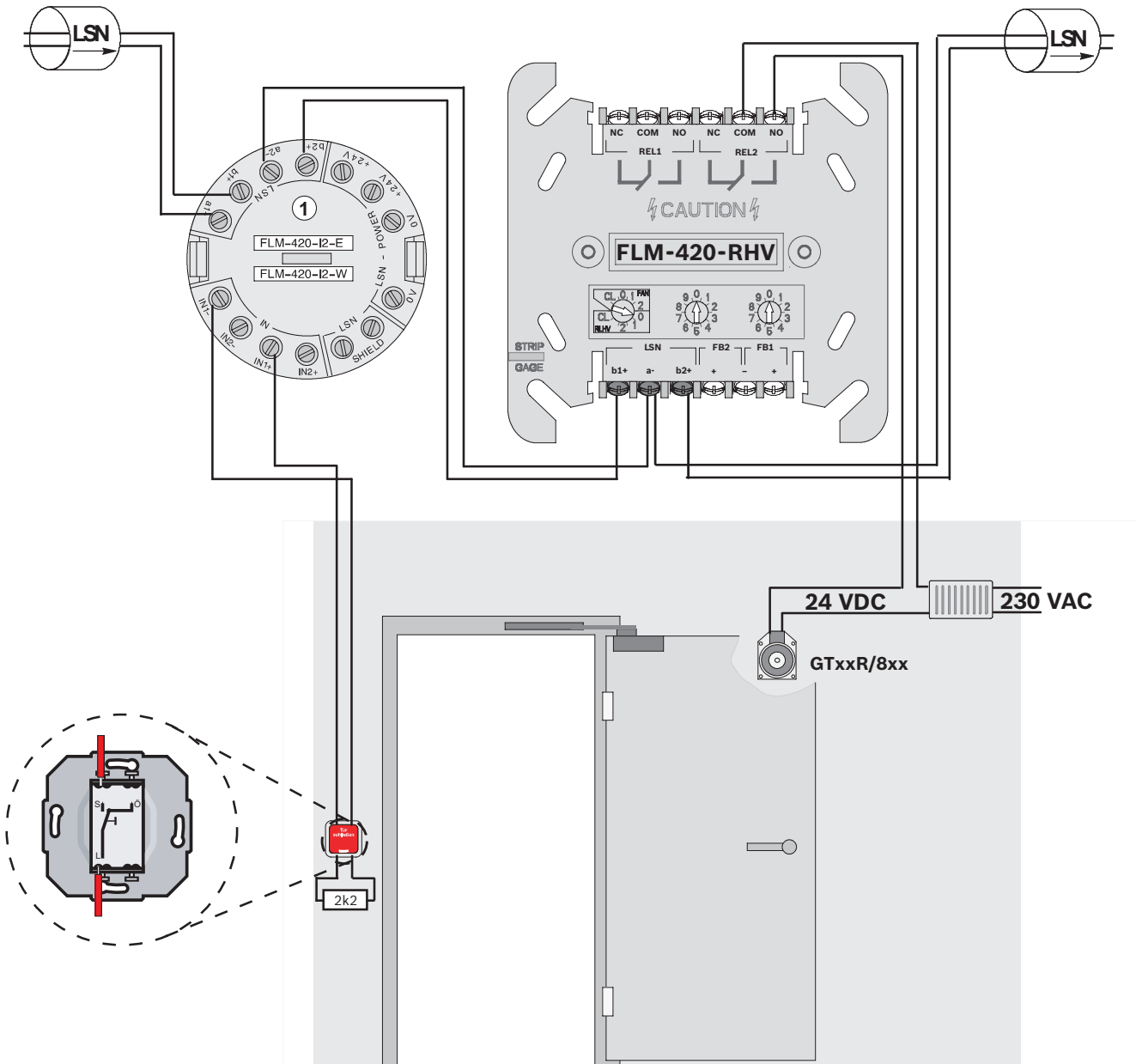

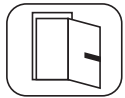

TS 73 EMF  
 TS 93 EMF  
 TS 93 GSR  
 BTS 80 EMB  
 BTS 80 FLB

DIBT

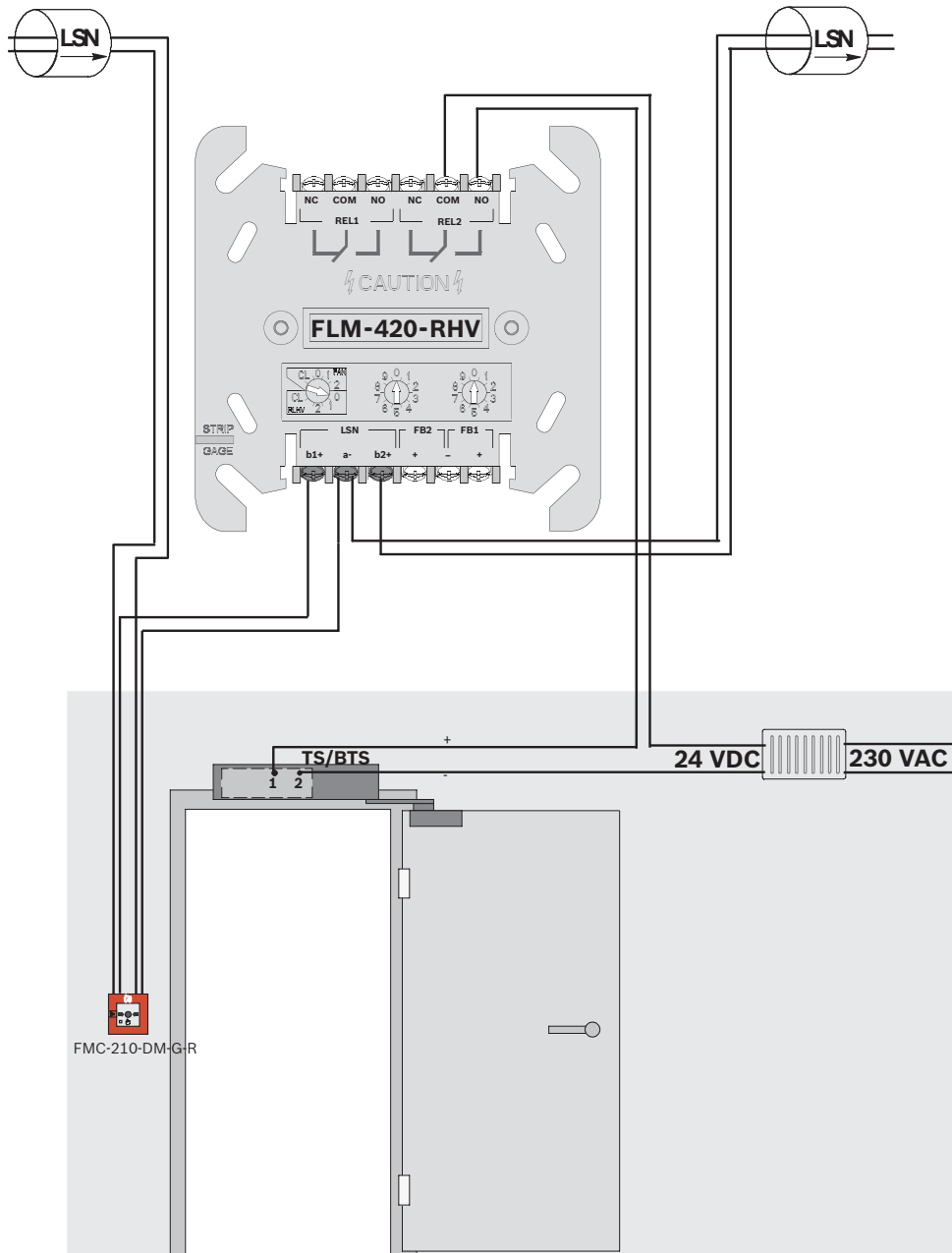



TS 73 EMF  
 TS 93 EMF  
 TS 93 GSR  
 BTS 80 EMB  
 BTS 80 FLB

DIBT

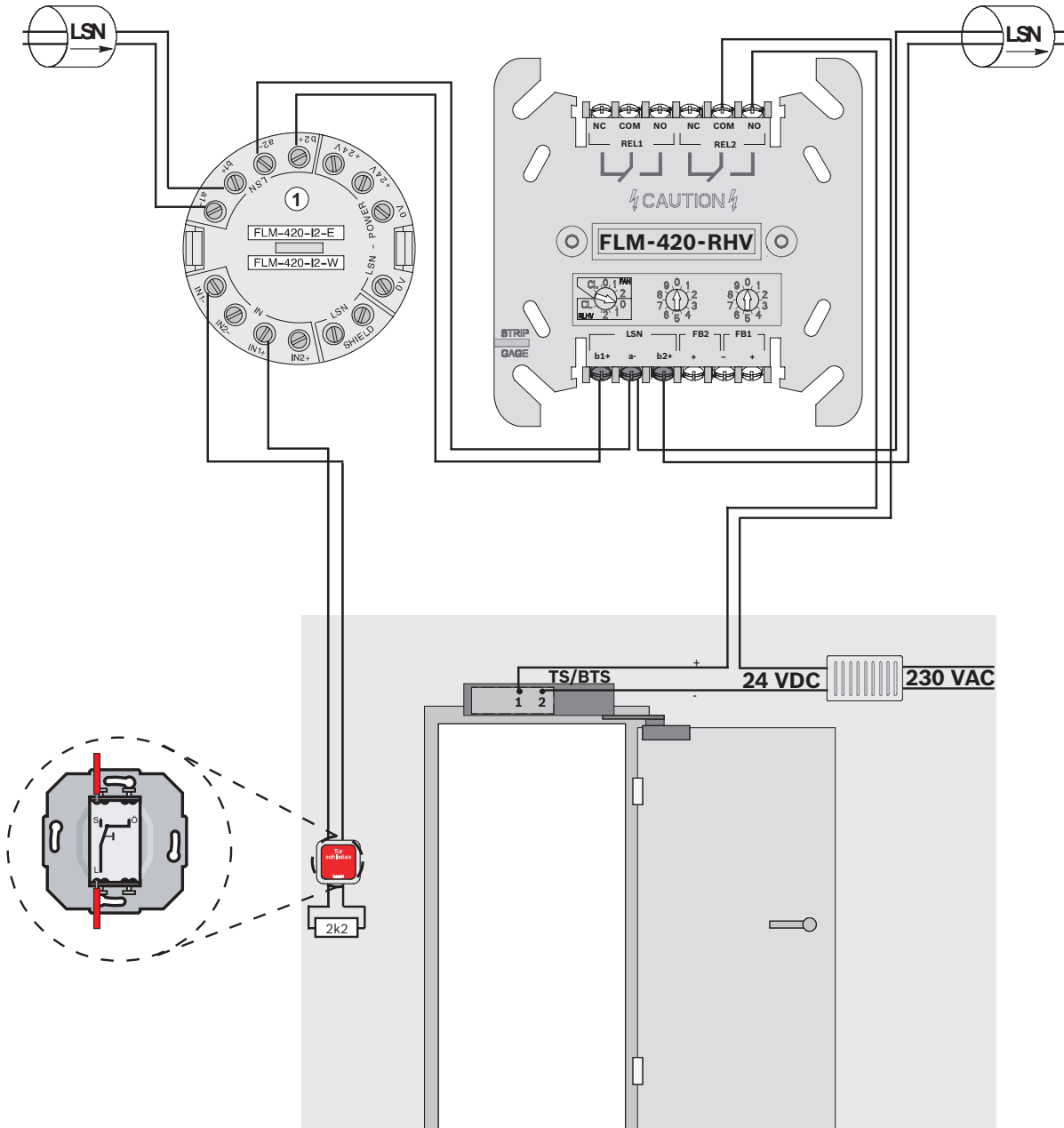



Slimdrive EMD-F/EMD F-IS

DIBT

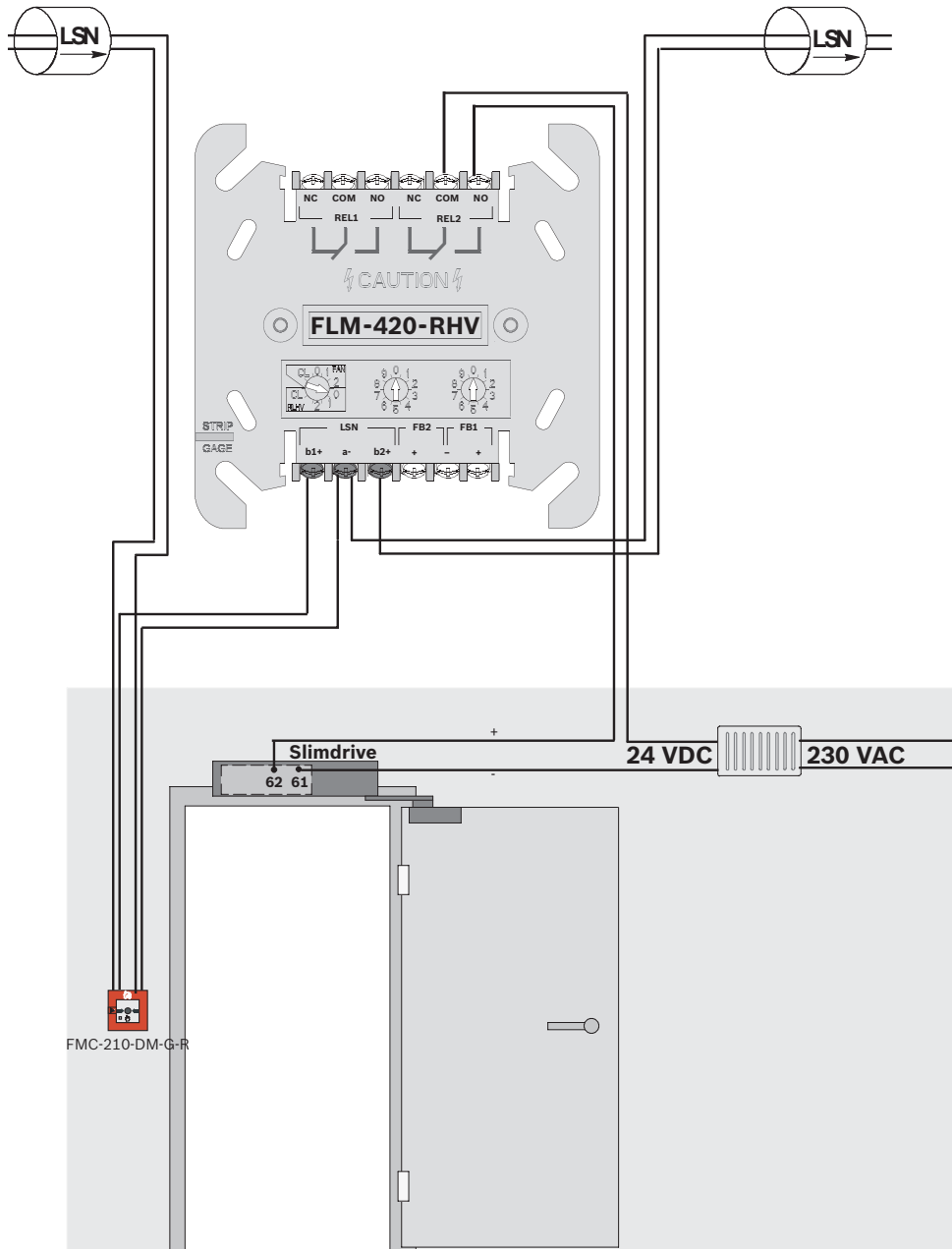

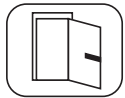

Slimdrive EMD-F/EMD F-IS

DIBT

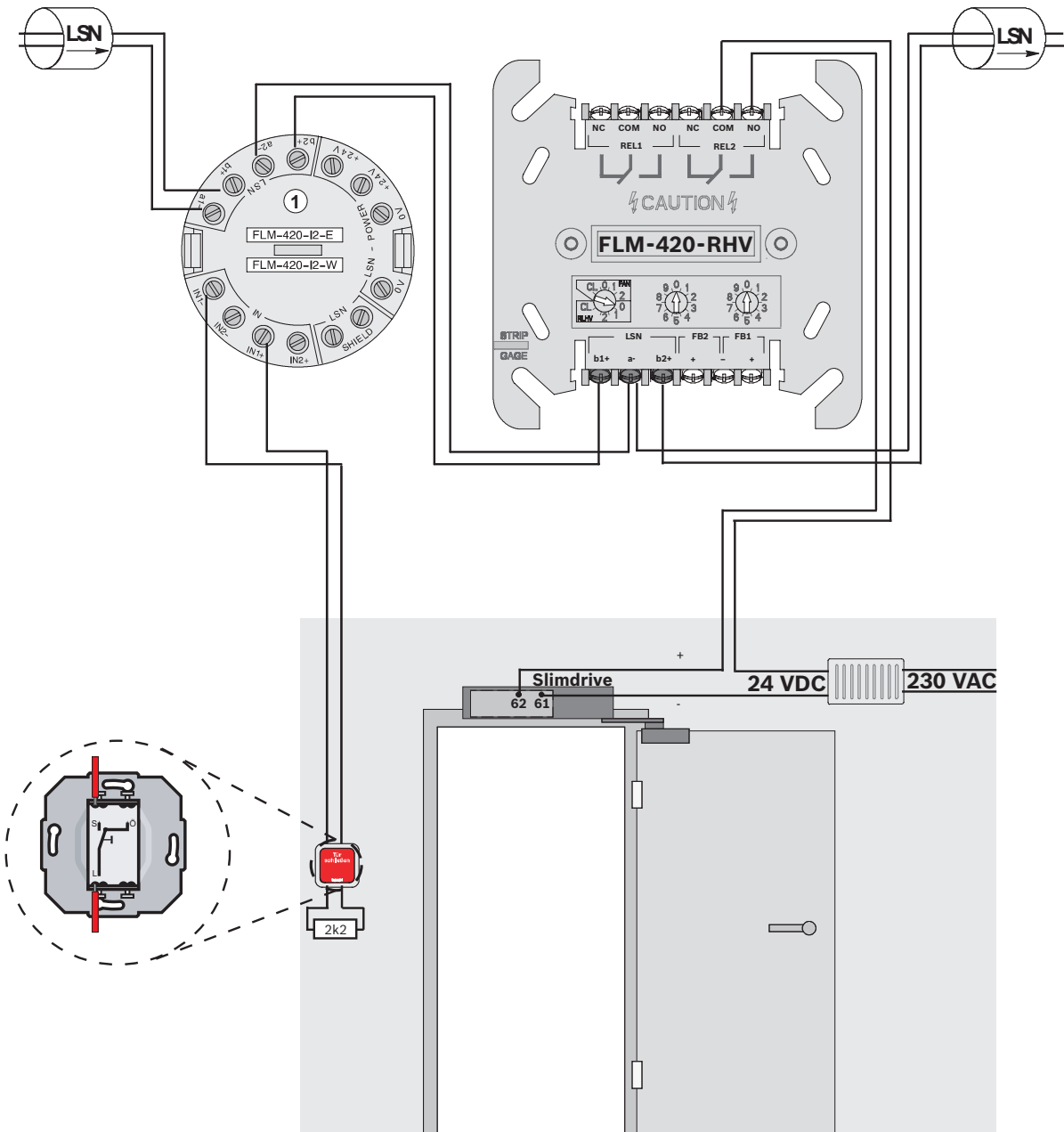

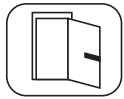

TS 4000 E/E-IS/EFS  
 TS 5000 E/E-IS/E-ISM  
 TS 550 E  
 TSA 160 NT F/F-IS/F-IS/TS

DIBT

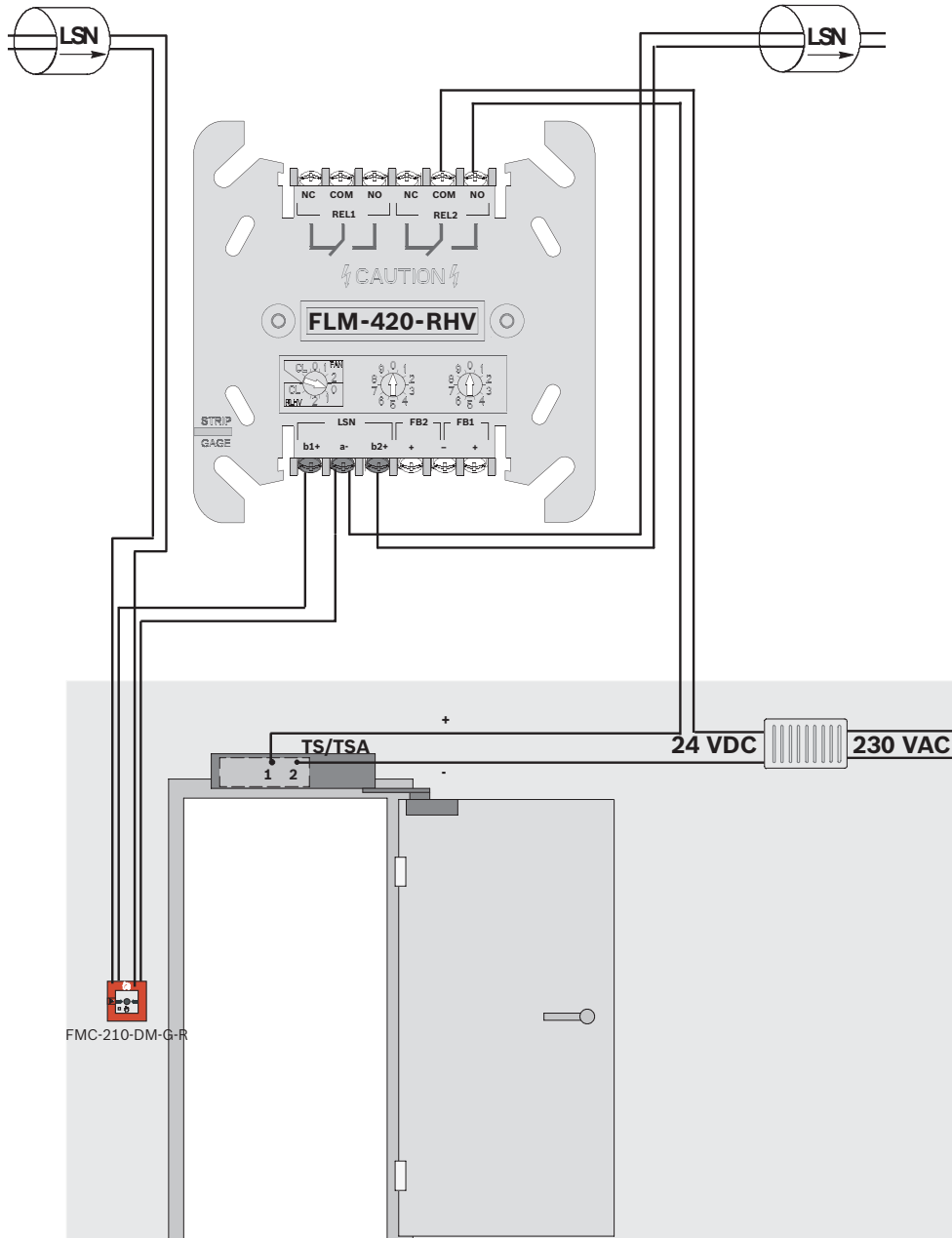





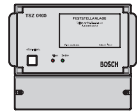
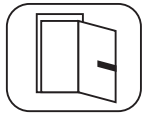

TSZ 0400

DIBT

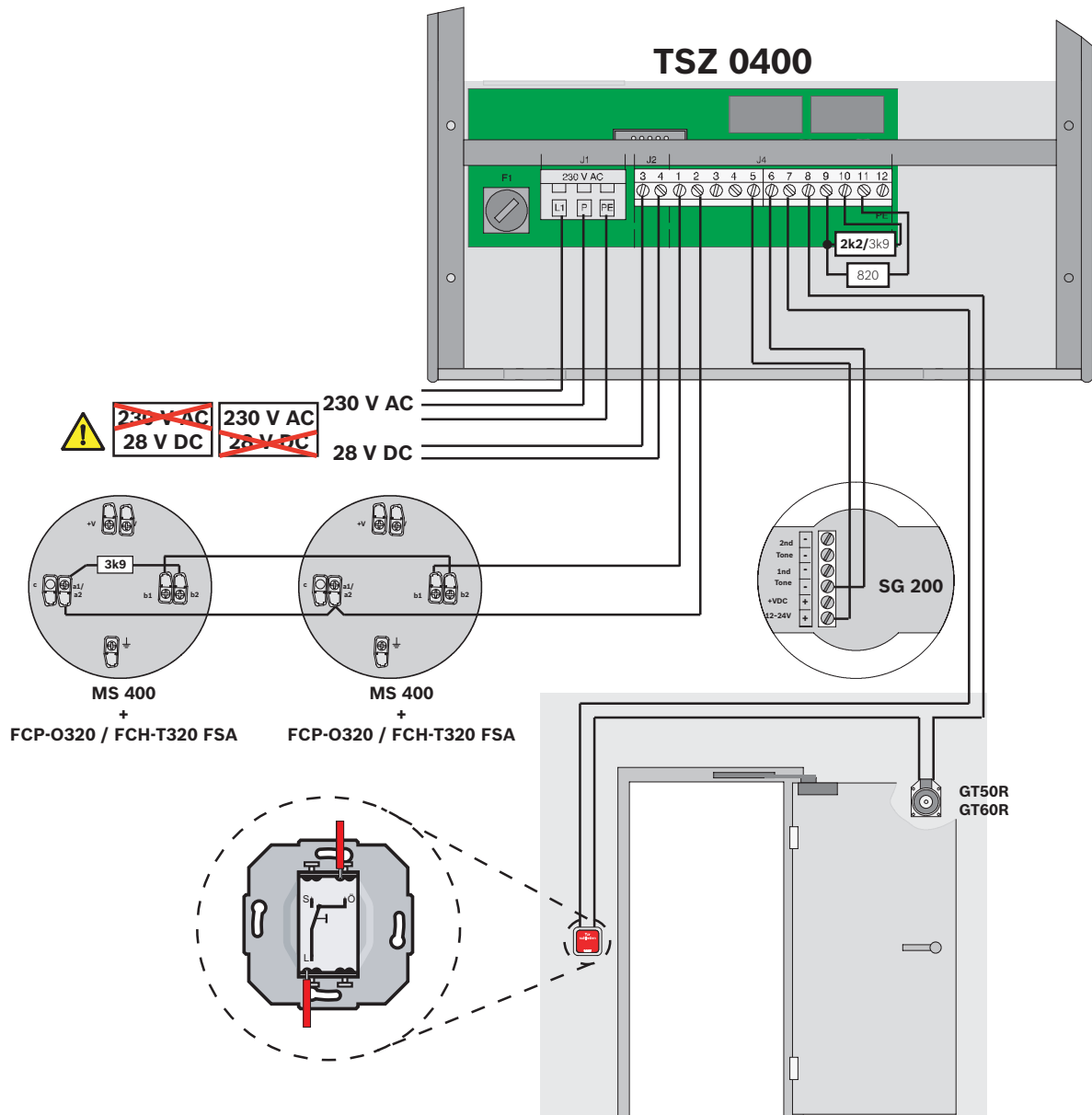

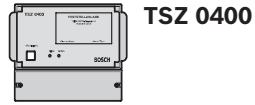

DIBT

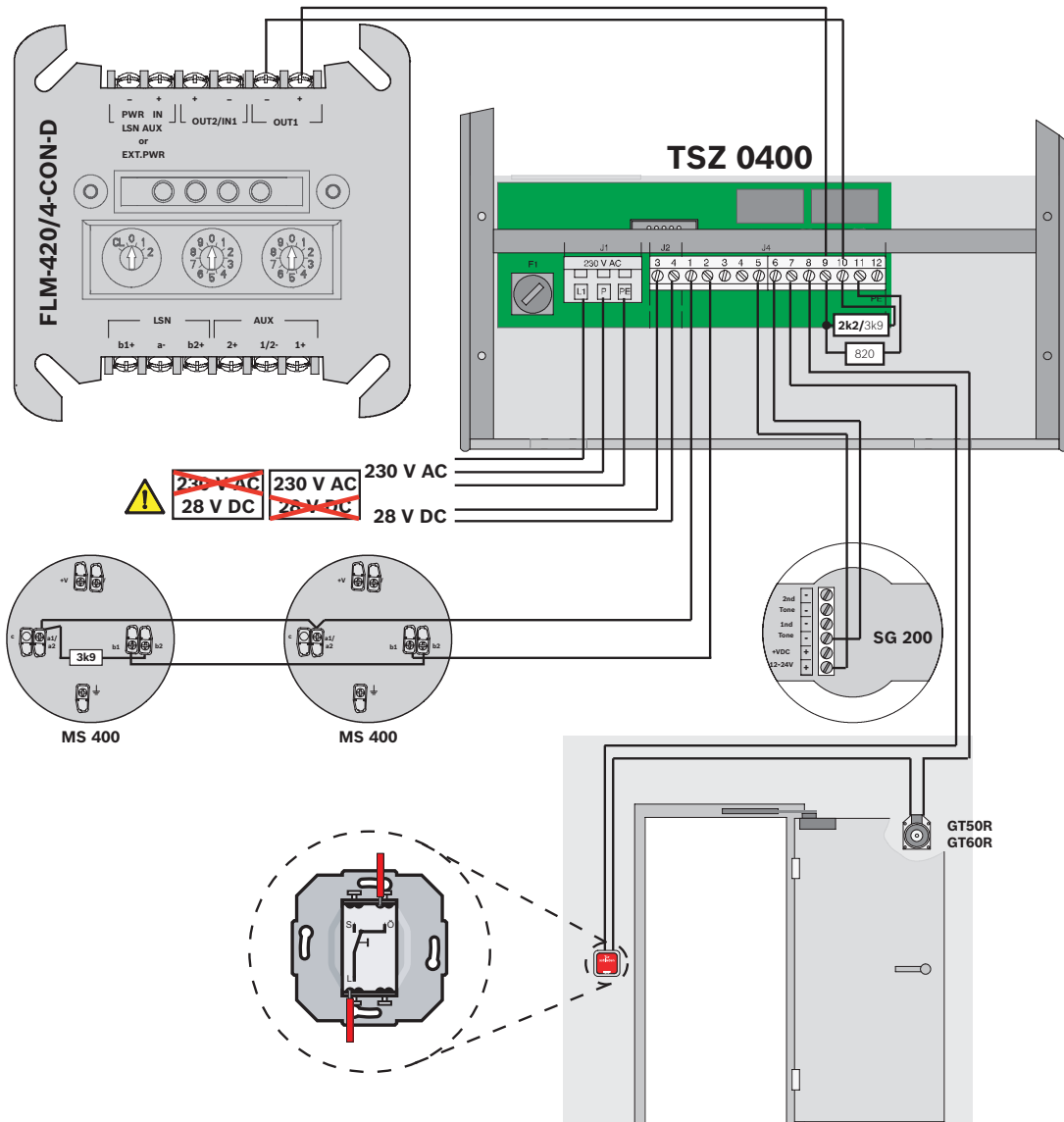

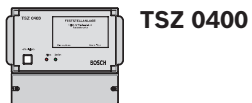

**DIBT**

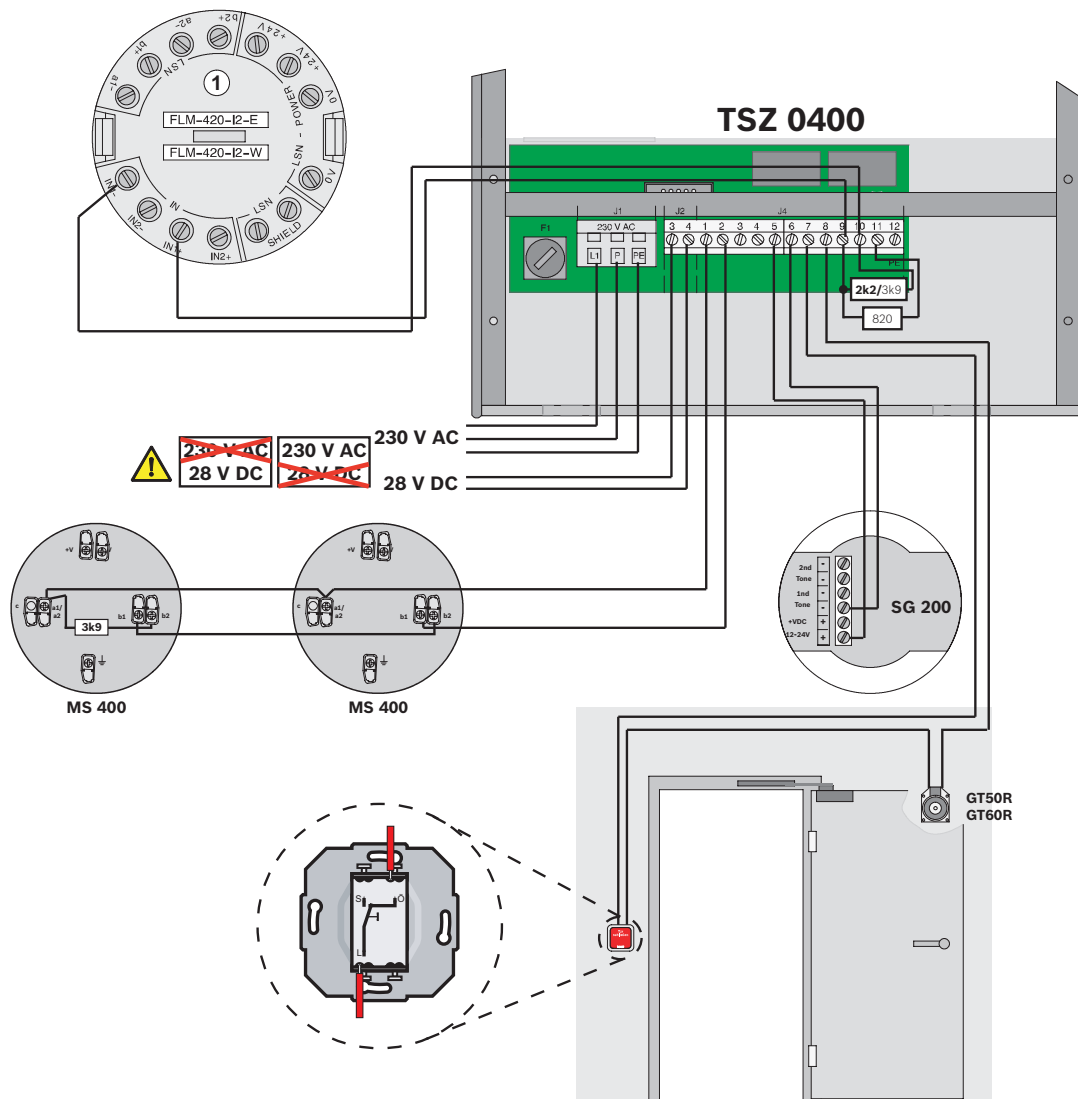

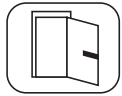

DIBT

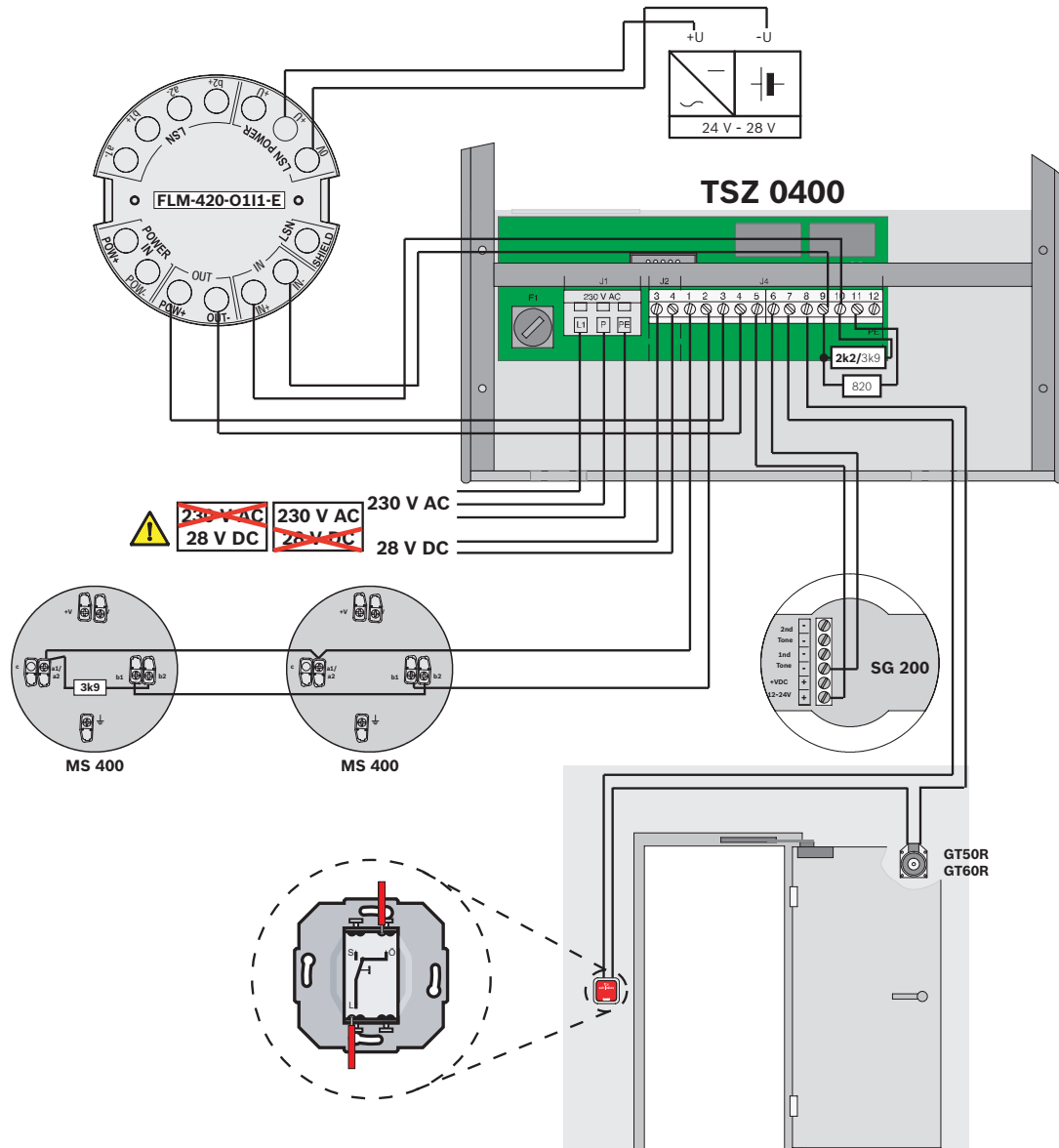

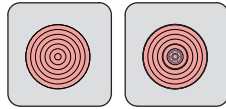

**FAA-420-RI-ROW**  
**FAA-420-RI-DIN**

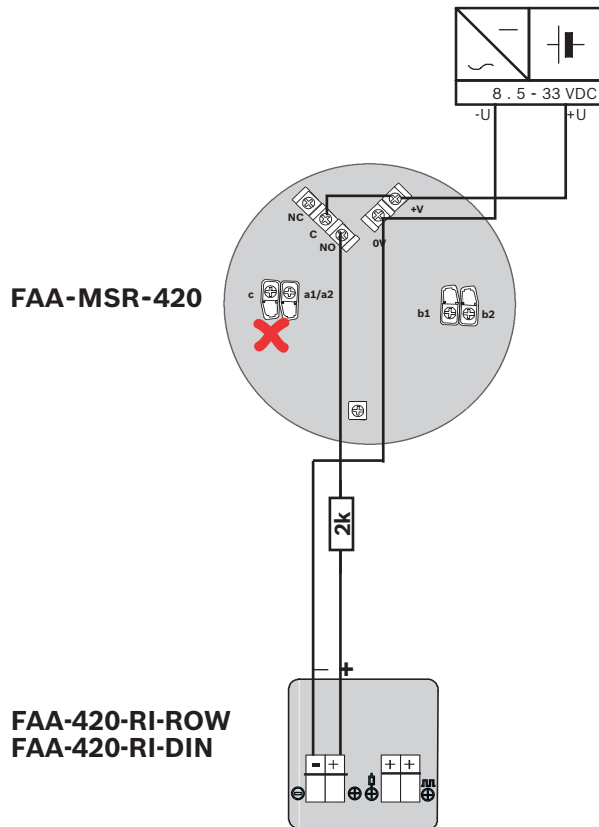
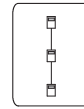

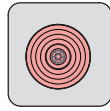

**FAA-420-RI-DIN**

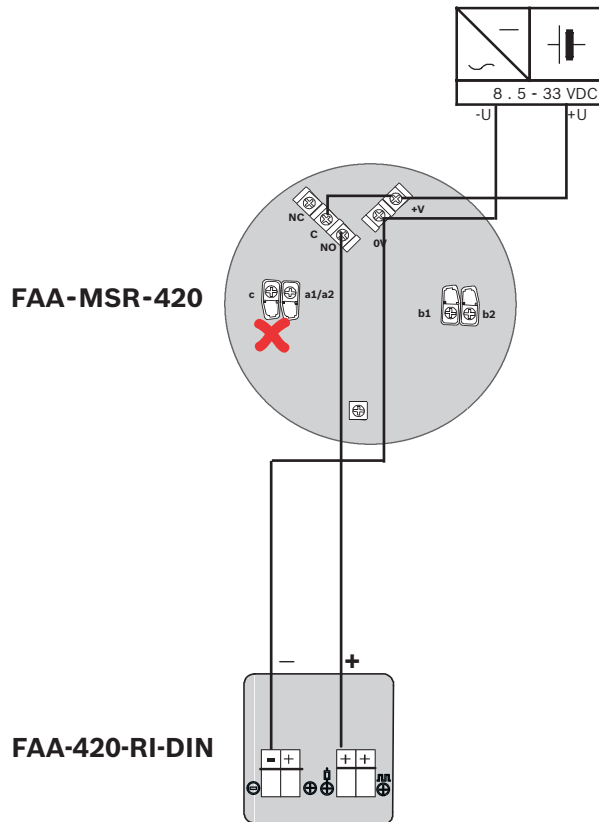
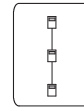

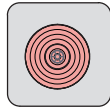

**FAA-420-RI-DIN**

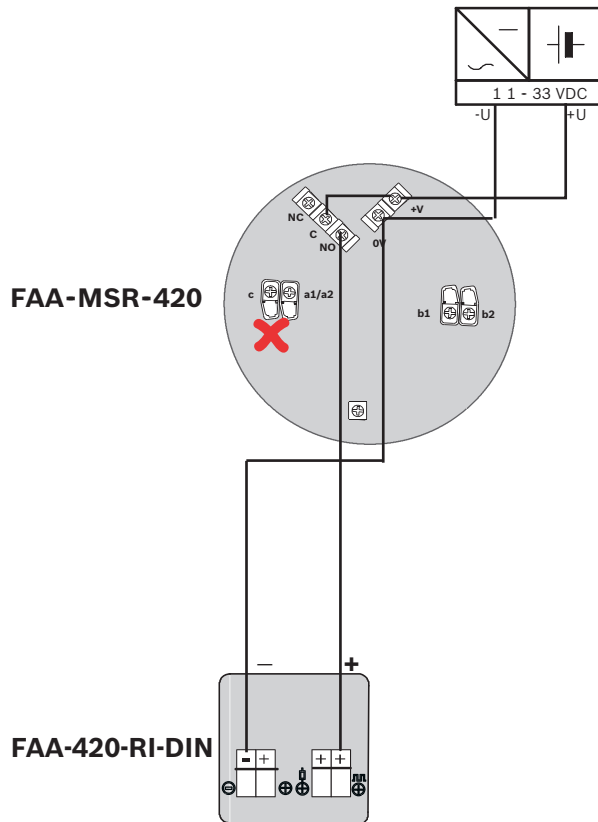
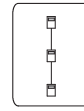

## 2.4

### Functional Modules



*BCM-000-B, pagina 43*

*CZM 0004 A, pagina 45*

*ENO 0000 A/B, pagina 61*

*LSN 0300 A, pagina 68*

*NZM 0002 A, pagina 106*

*RMH 0002 A, pagina 119*

*IOS 0020 A, pagina 120*

*FPE-5000-UGM, pagina 122*



2.4.1

BCM-000-B

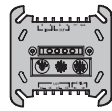
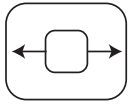

FLM-420-NAC-D

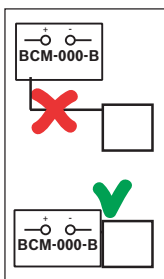
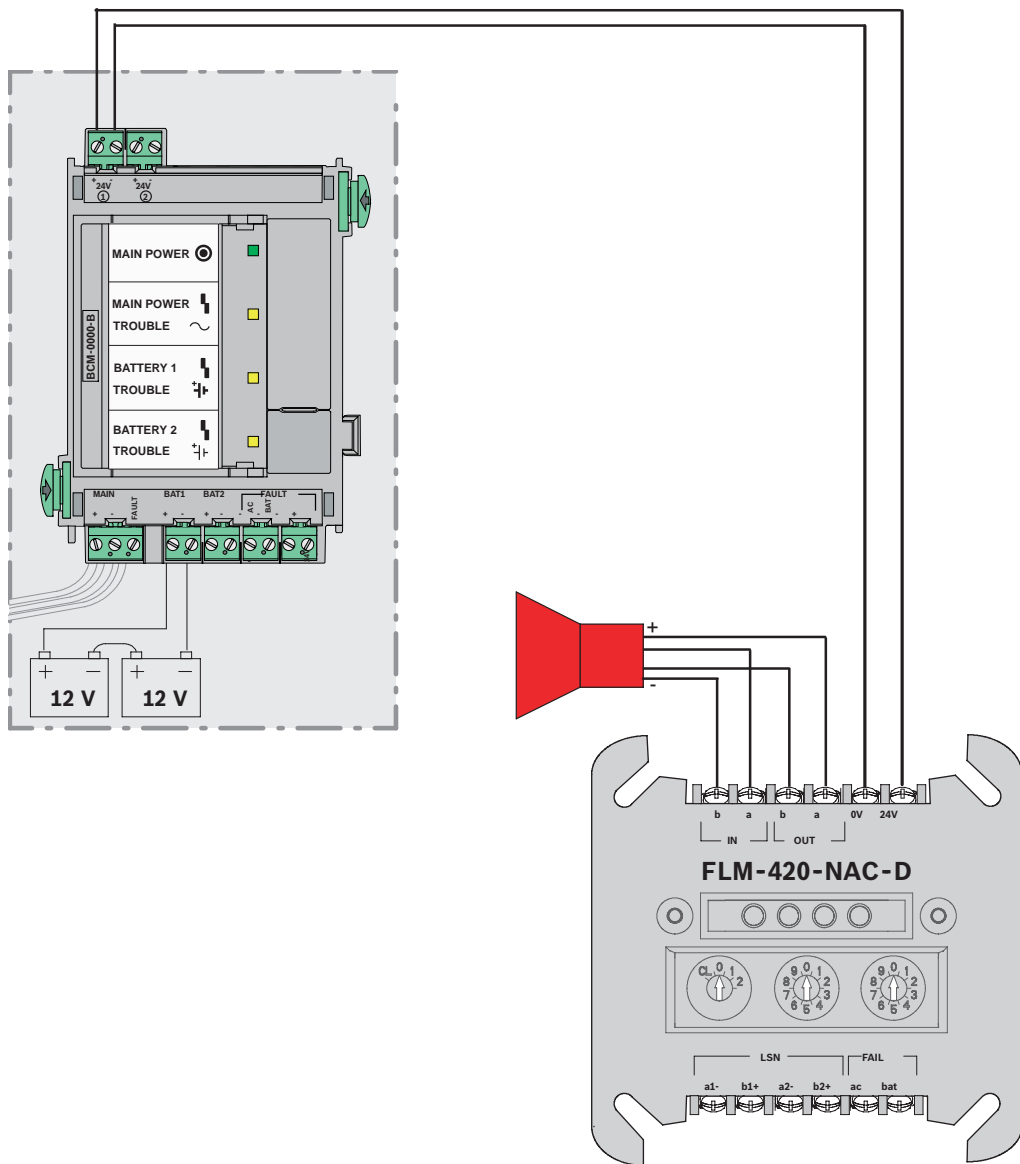
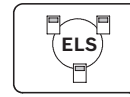

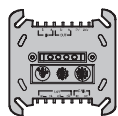
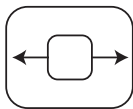

FLM-420-NAC-D

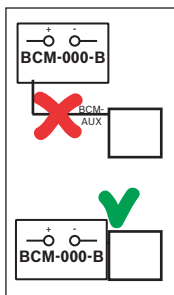
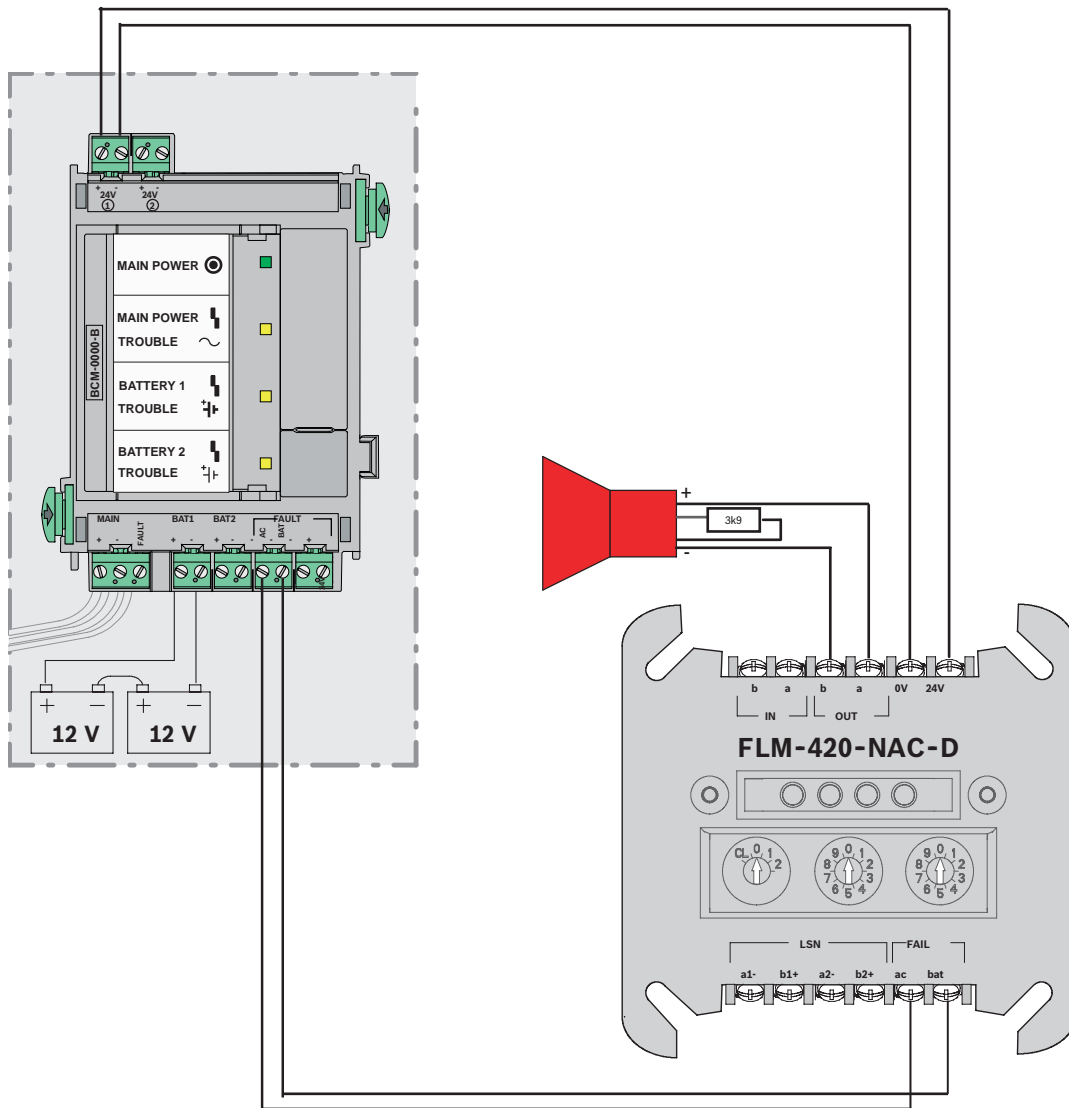
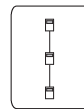

2.4.2

CZM 0004 A



**Firearay 50RV**  
**Firearay 100RV**

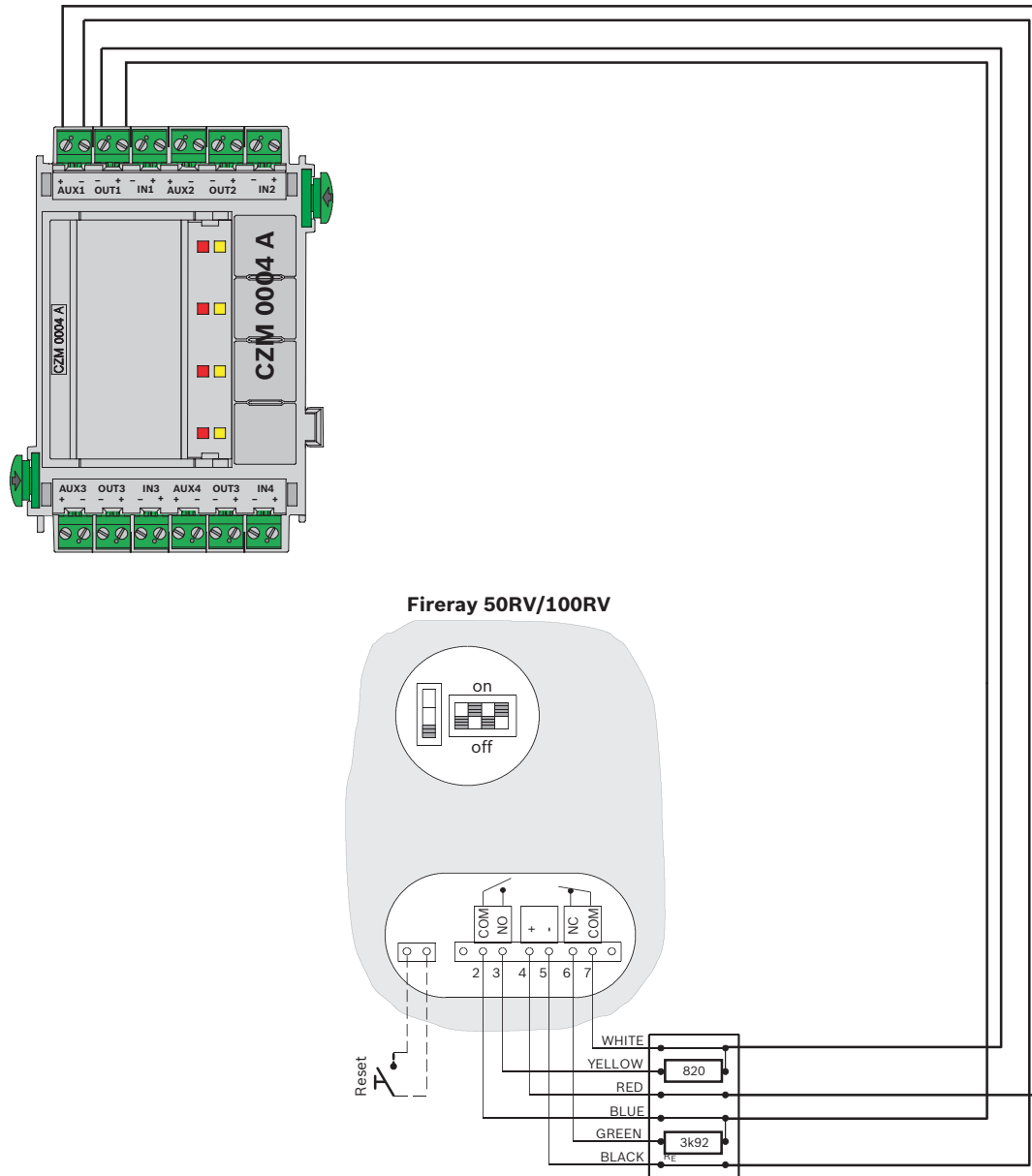



**FIRERAY3000**

1 x



BCM-0000-B  
LSN 0300 A  
LSN 1500 A

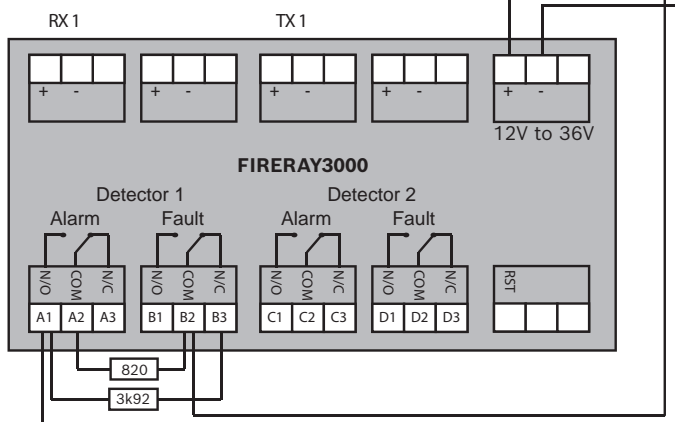
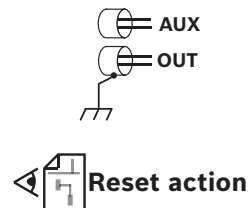
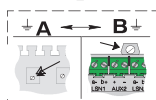
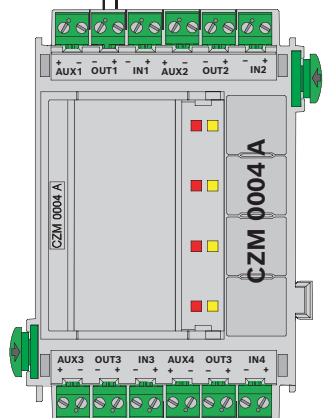



**FIRERAY3000**

2 x  **OUT1**



BCM-000-B  
LSN 0300 A  
LSN 1500 A

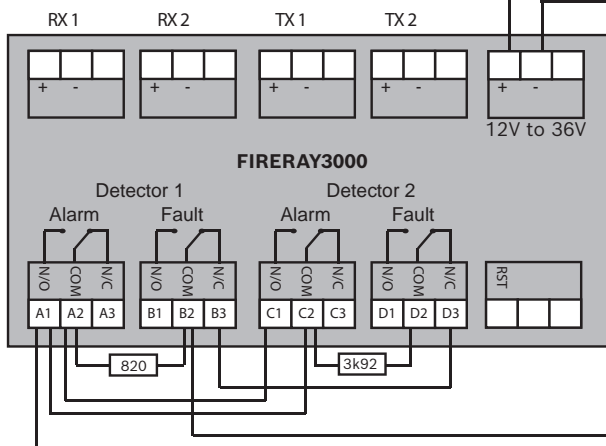
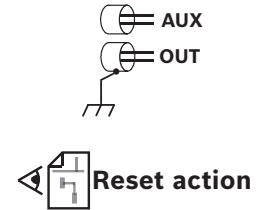
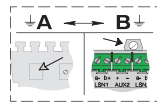
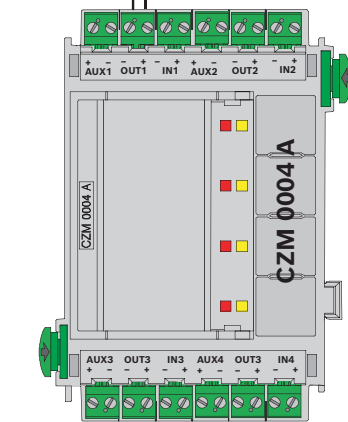

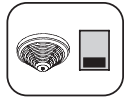

**FIRERAY3000**  
2 x **OUT1+2**



BCM-0000-B  
LSN 0300 A  
LSN 1500 A

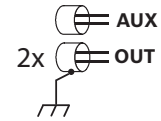
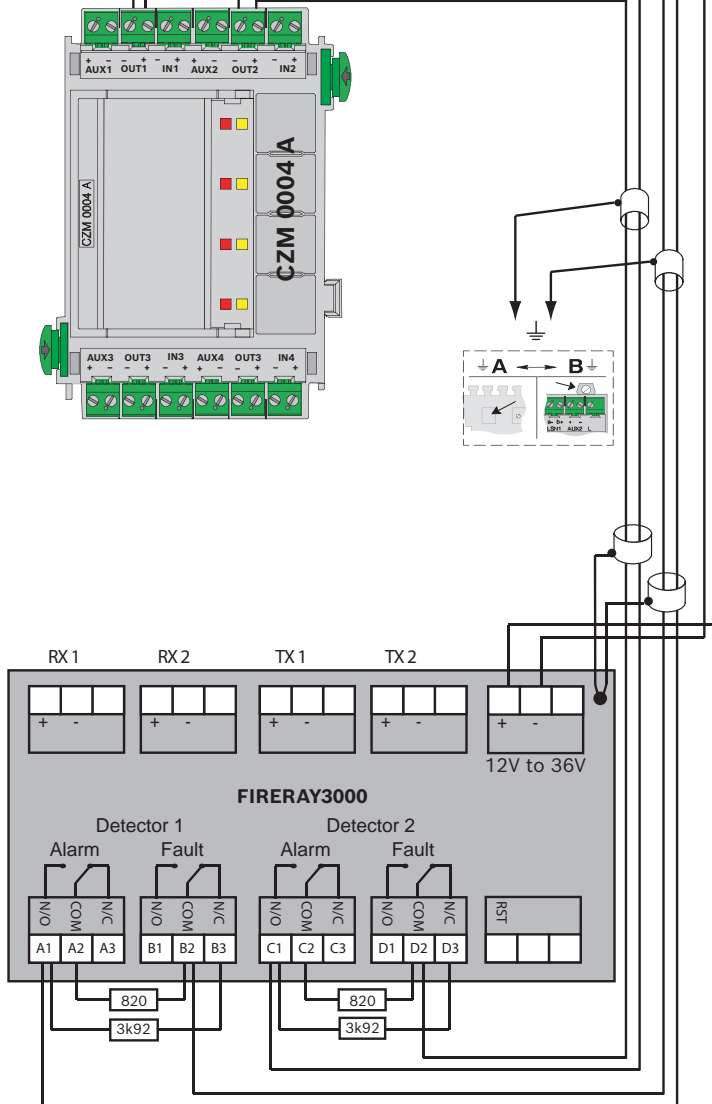

**Reset action**



**FIRERAY5000**

1 x



BCM-0000-B  
LSN 0300 A  
LSN 1500 A

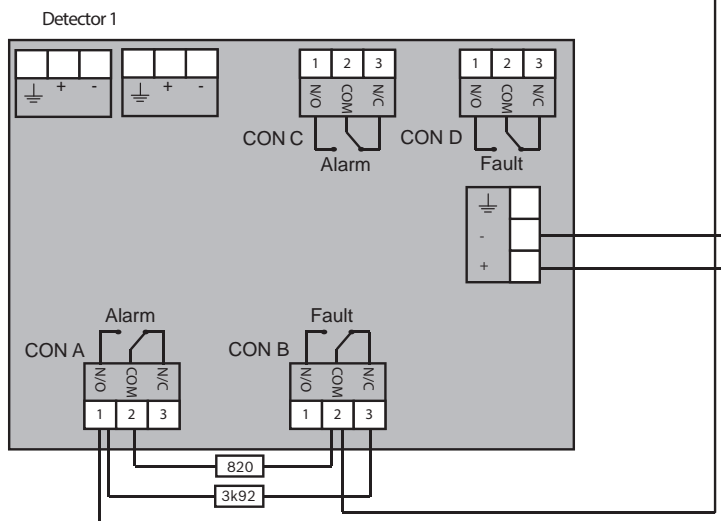
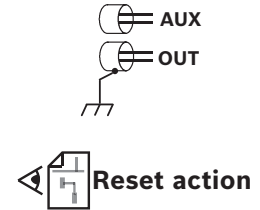
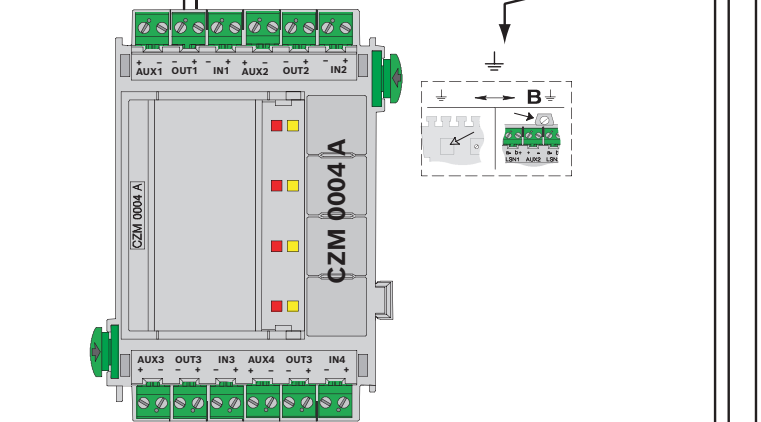



**FIRERAY5000**

**2 x OUT1**

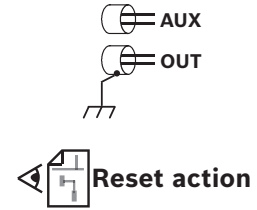
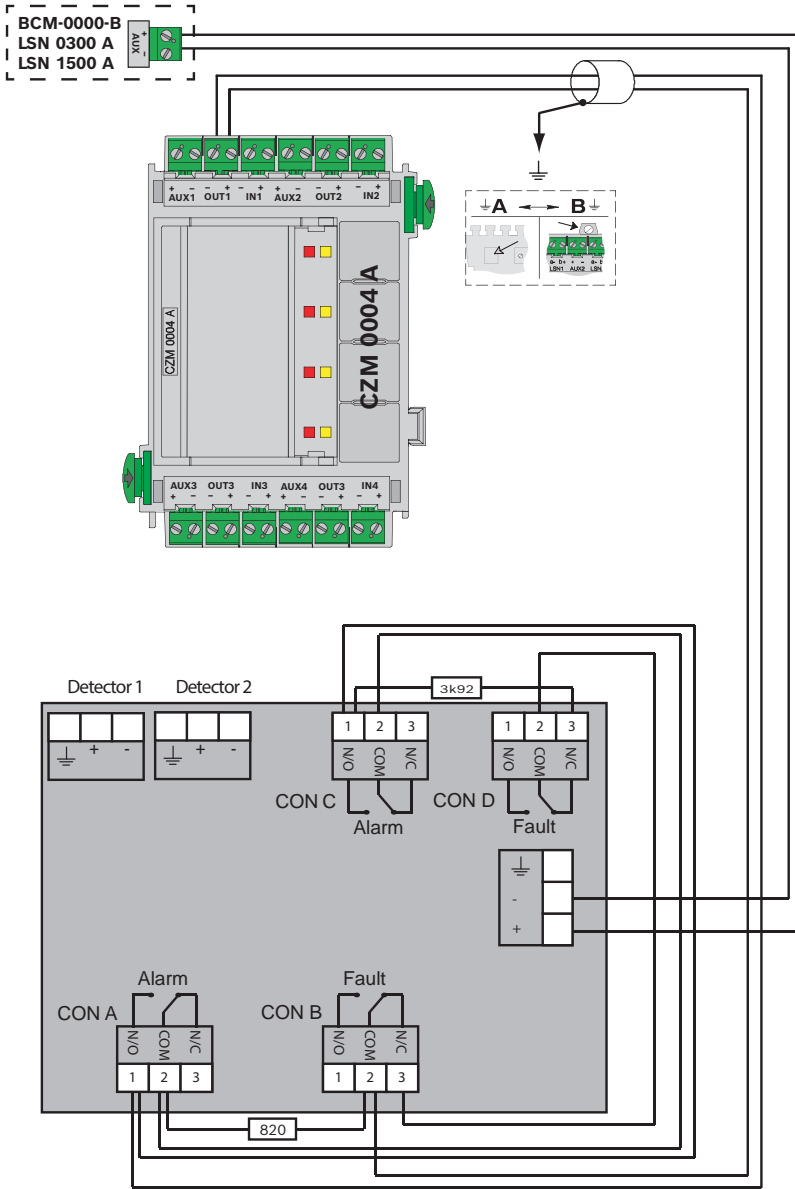



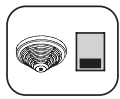

**FIRERAY5000**  
2 x  **OUT1**

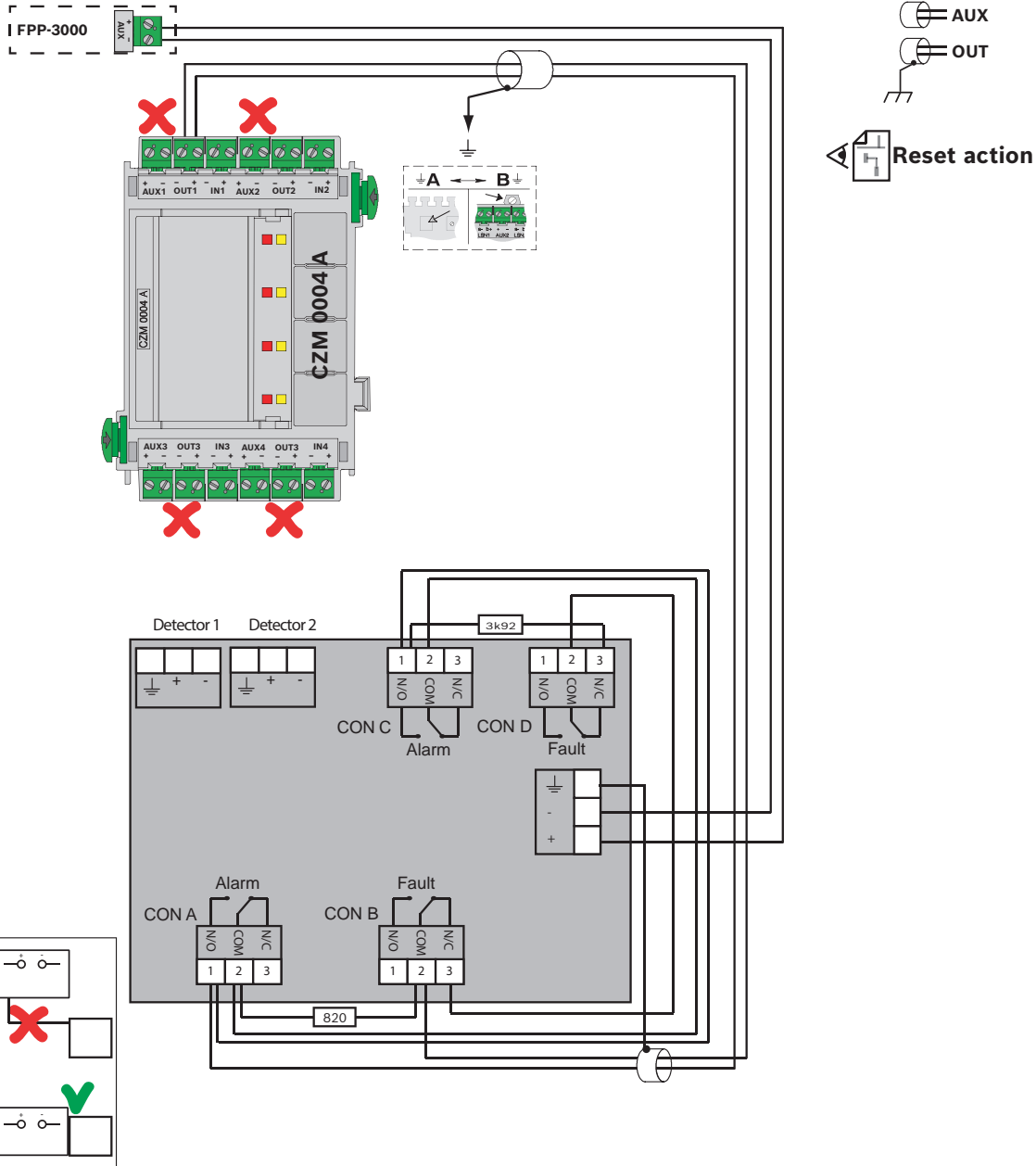

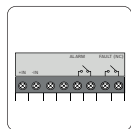

**016519, 016589**  
**IR3 Flame Detector**

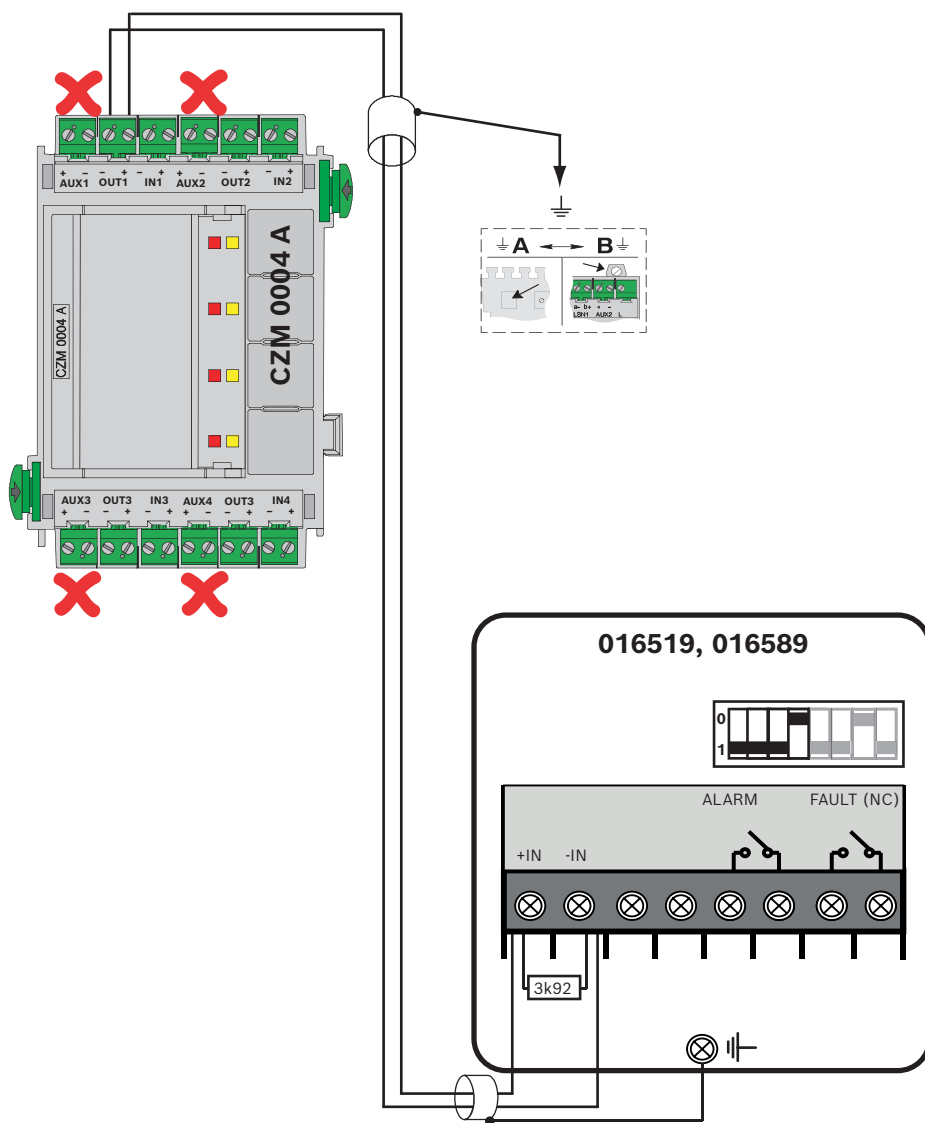
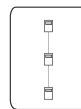

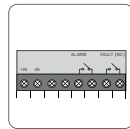

**016519, 016589  
IR3 Flame Detector**

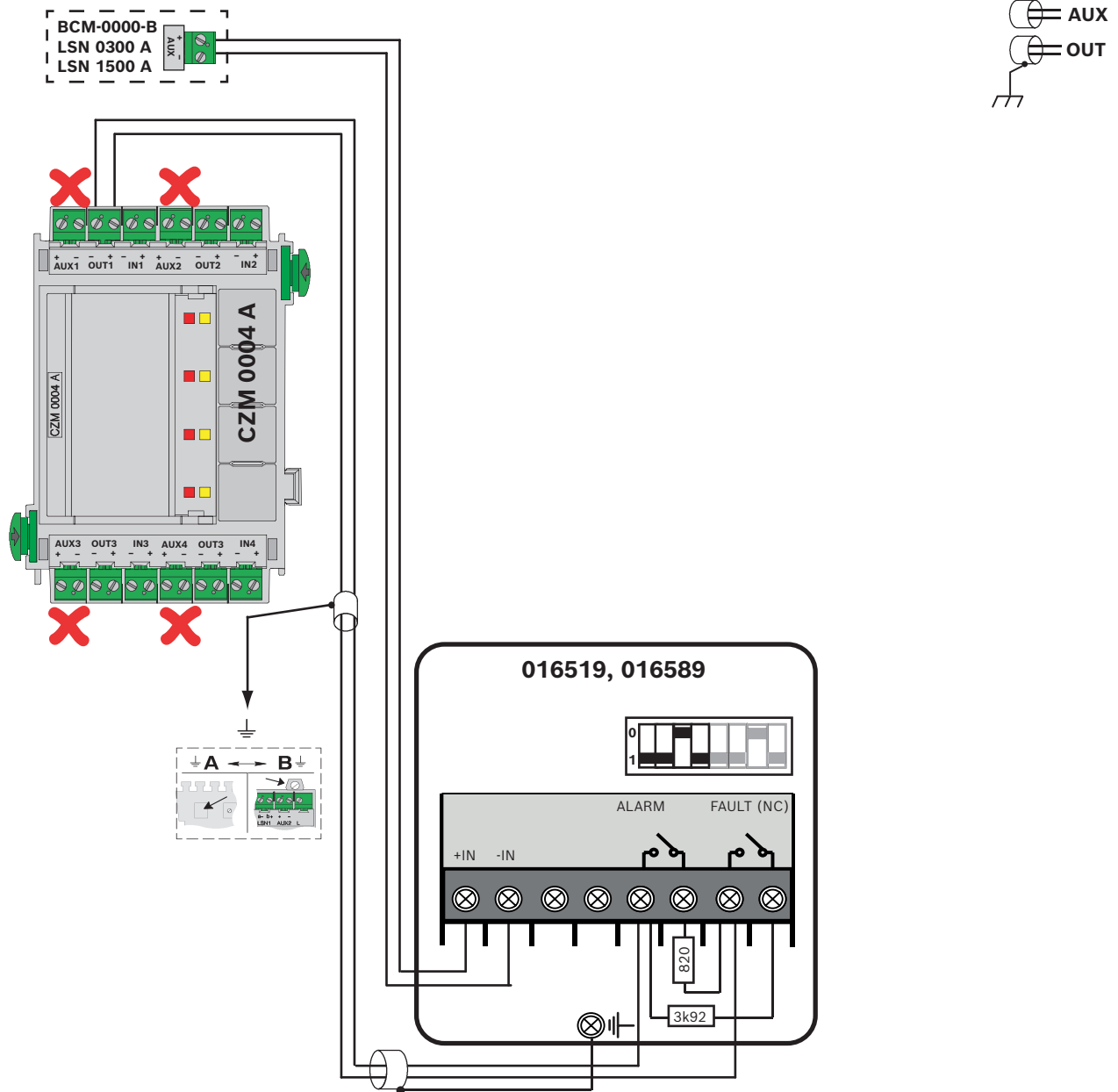
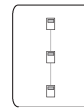

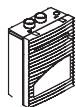

FCS-320-TM Series



BCM-0000-B  
LSN 0300 A  
LSN 1500 A

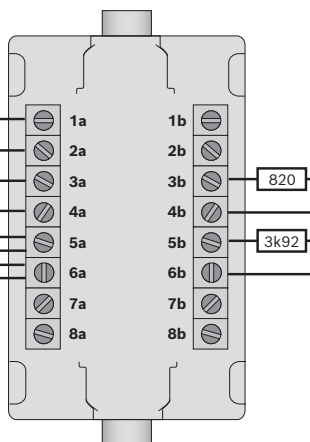
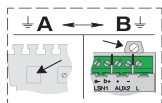
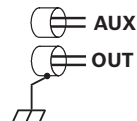
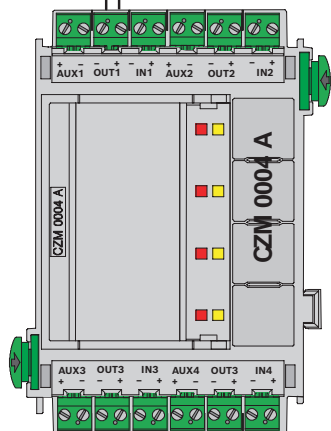

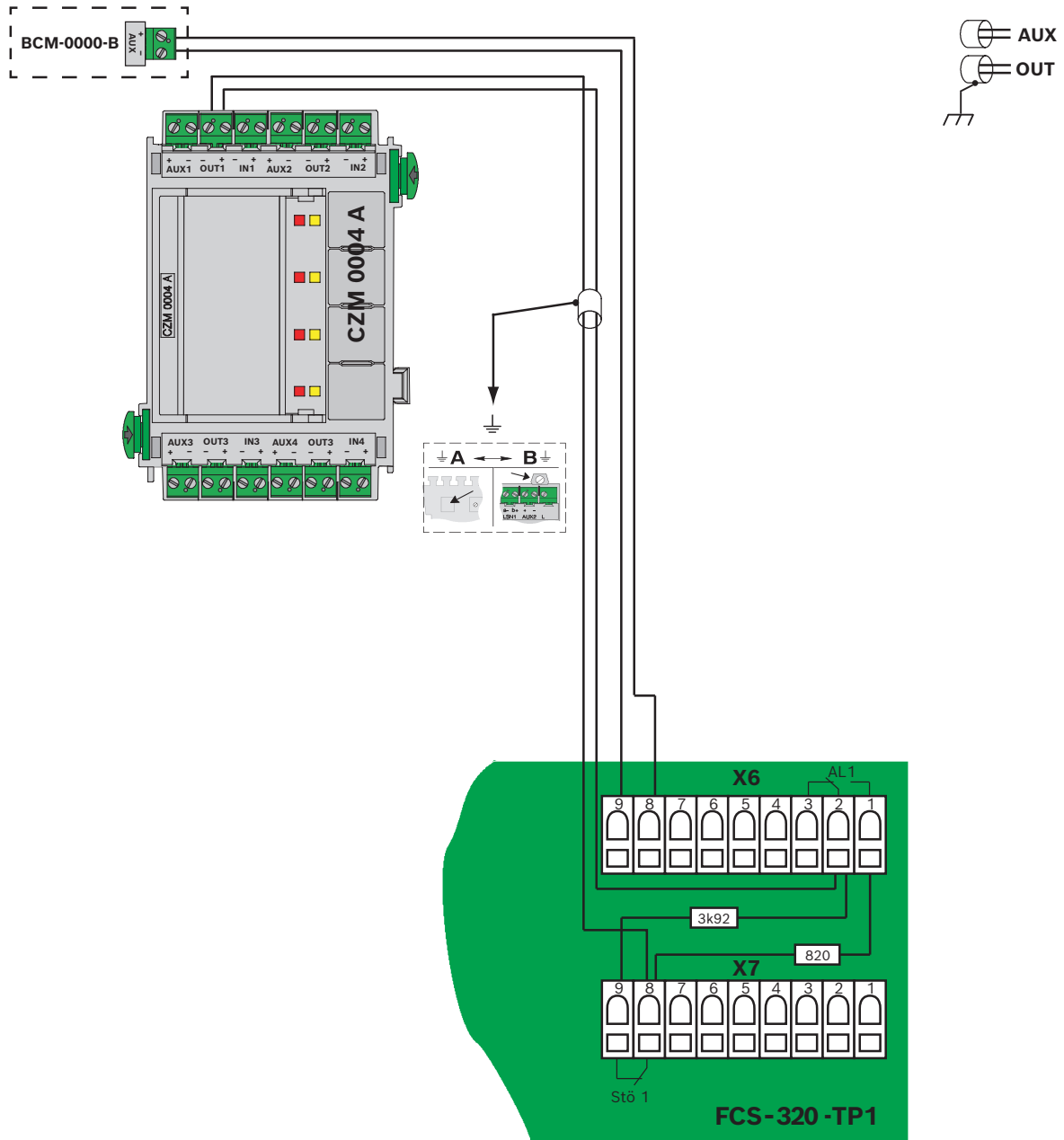
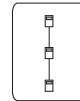
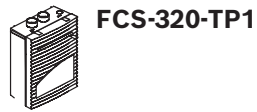

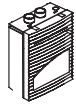

FCS-320-TP2

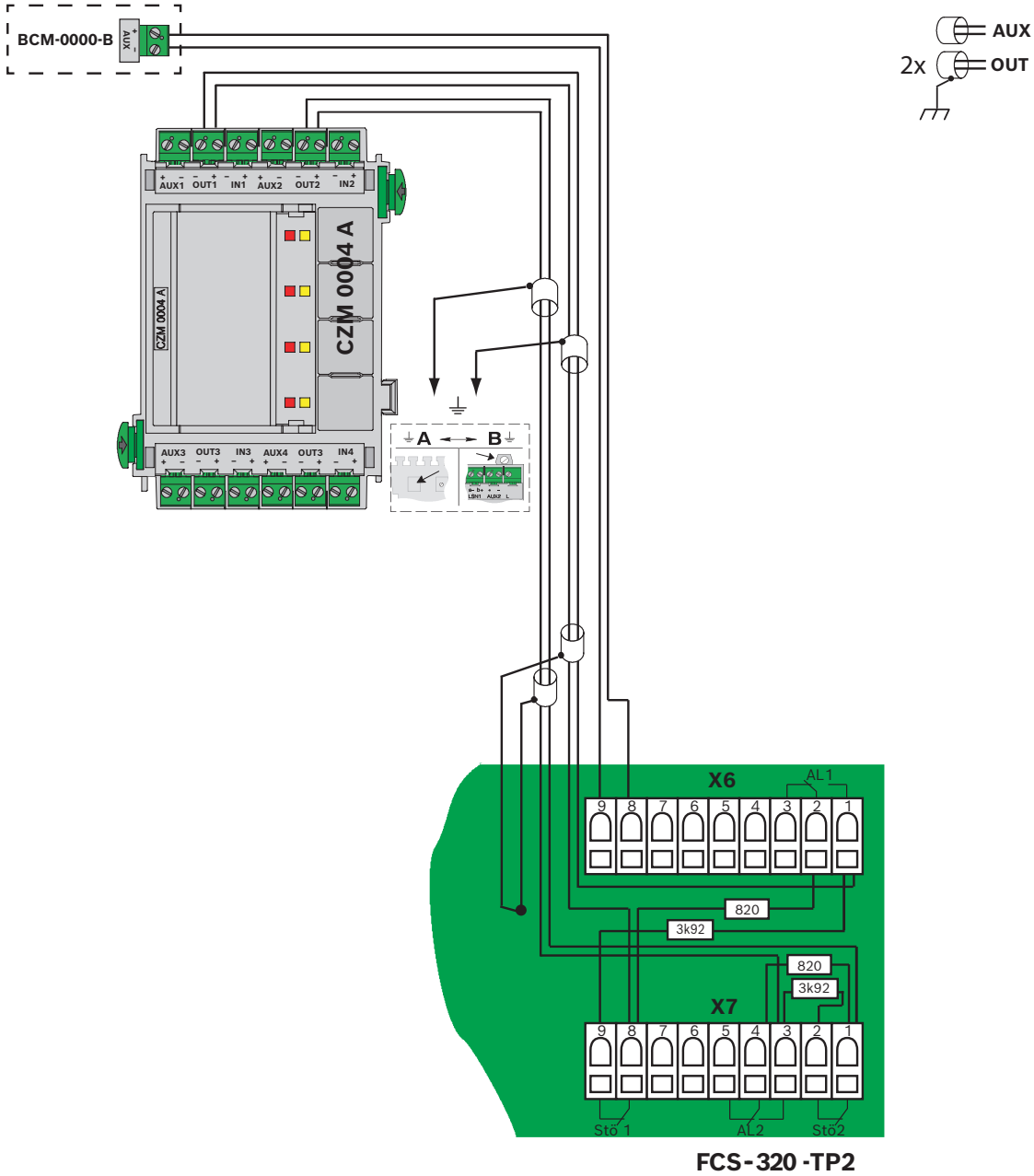

FCS-320-TP2



FCS-LWM-1

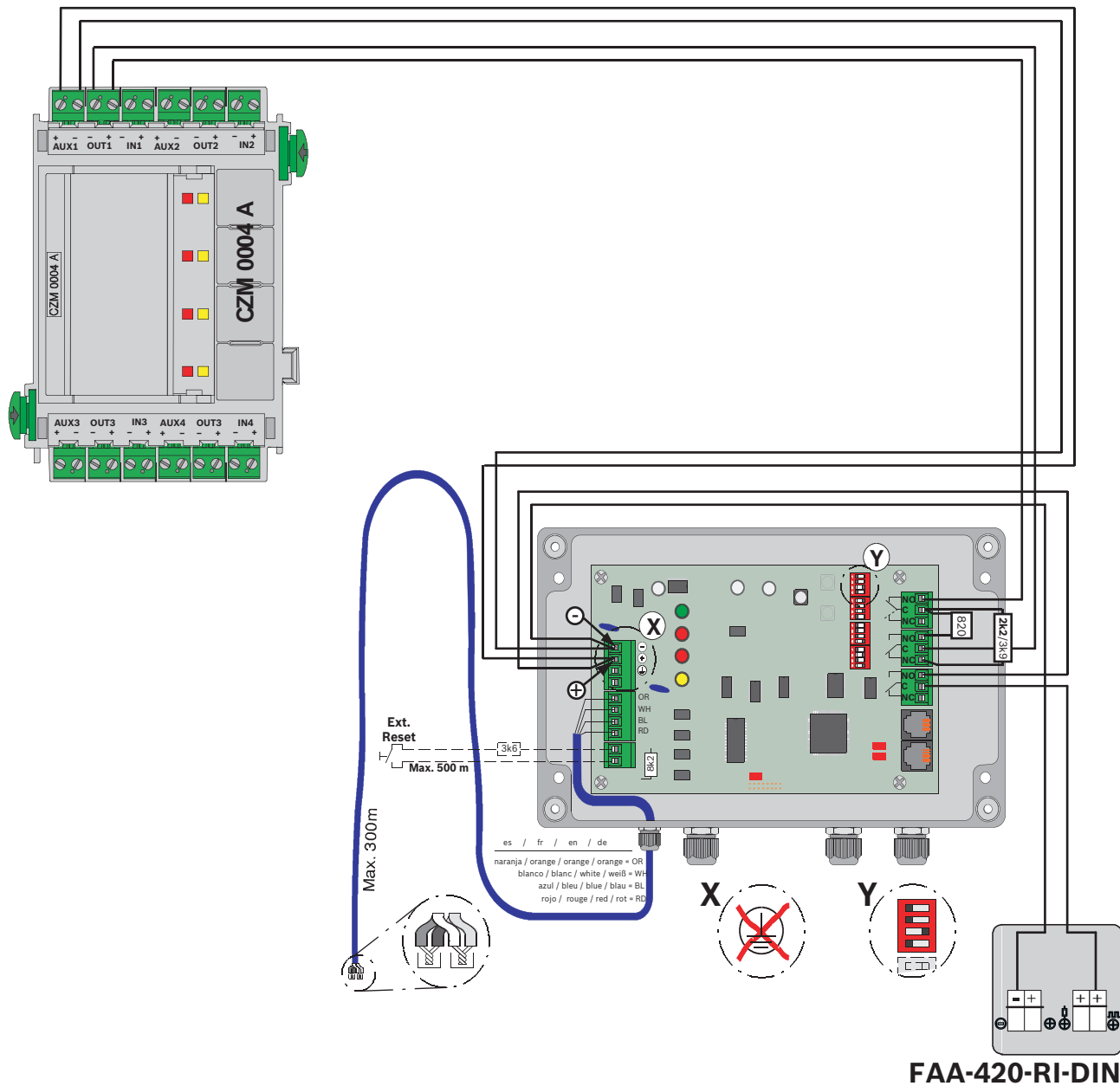



FCA-500-EU  
 FCP-O 500  
 FCP-O 500-P  
 FCP-OC 500  
 FCP-OC 500-P

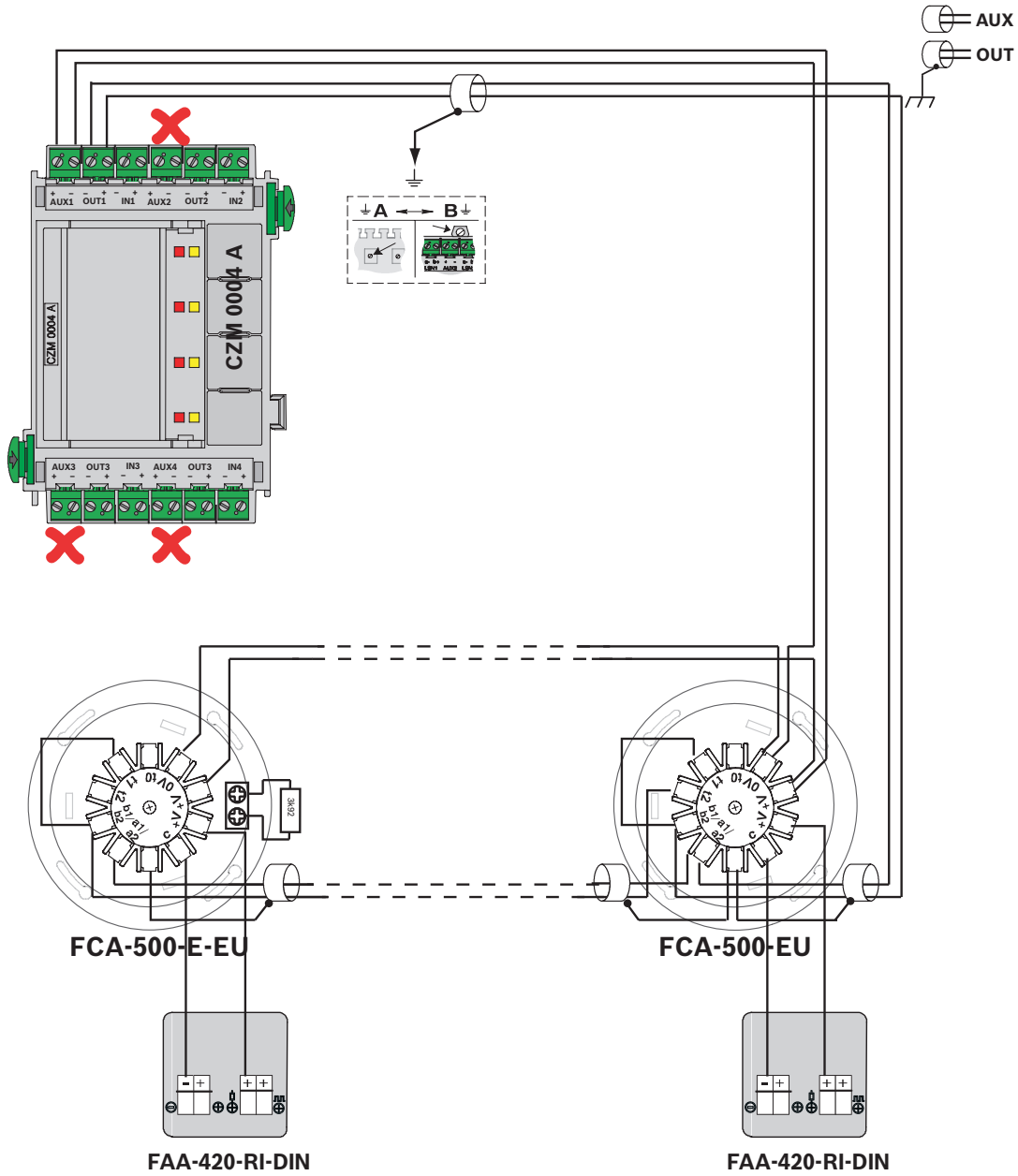



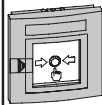

**FMC-120-DKM-G-R**  
**FMC-120-DKM-H-R**  
**FMC-120-DKM-G-B**  
**FMC-120-DKM-H-B**  
**FMC-120-DKM-G-Y**

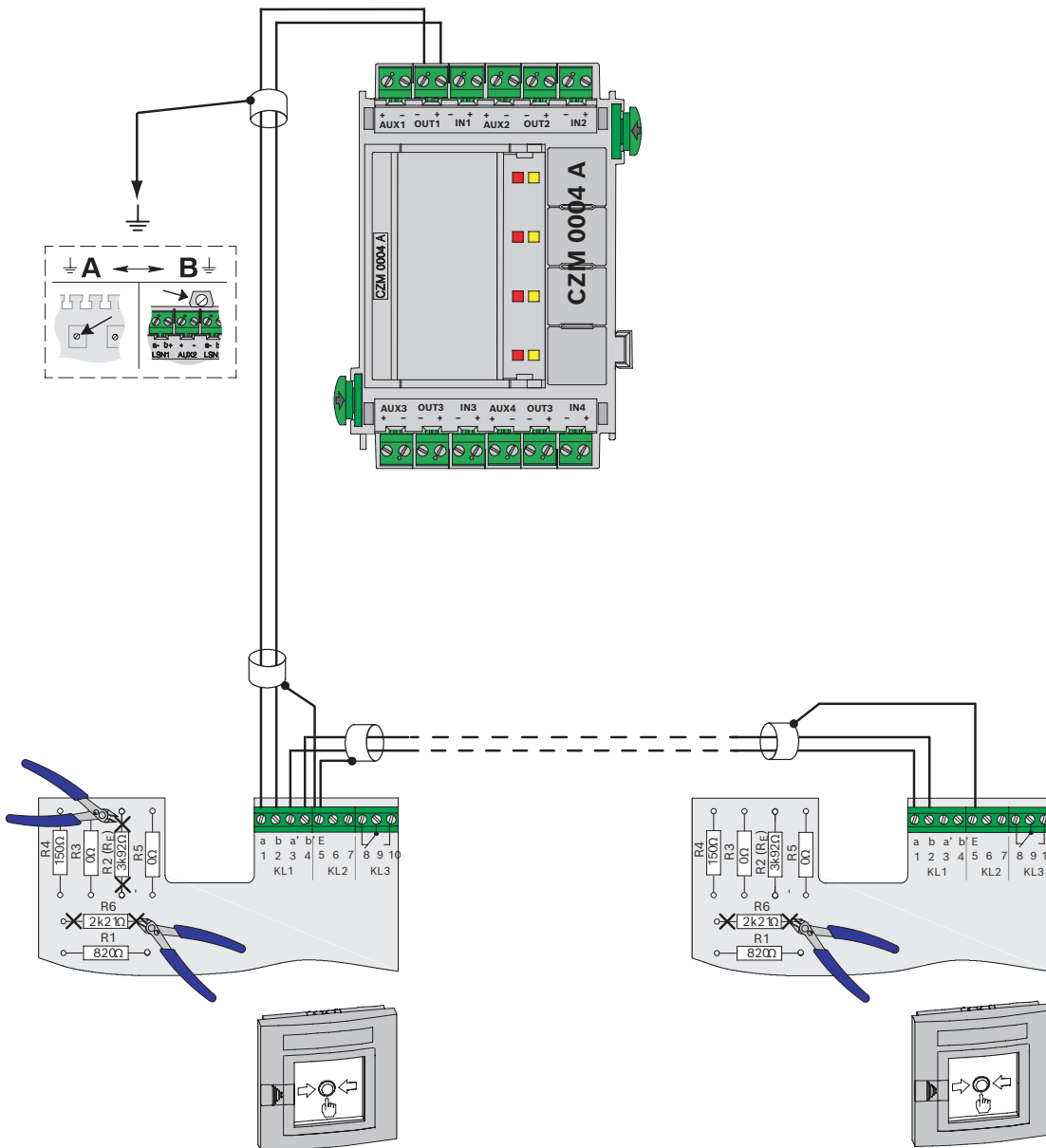
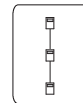

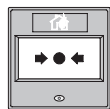
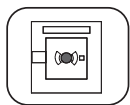

**FMC-300RW-GSGBU**  
**FMC-300RW-GSRBU**  
**FMC-300RW-GSGRD**  
**FMC-300RW-GSRRD**  
**FMC-300RW-GSGYE**  
**FMC-300RW-GSRYE**

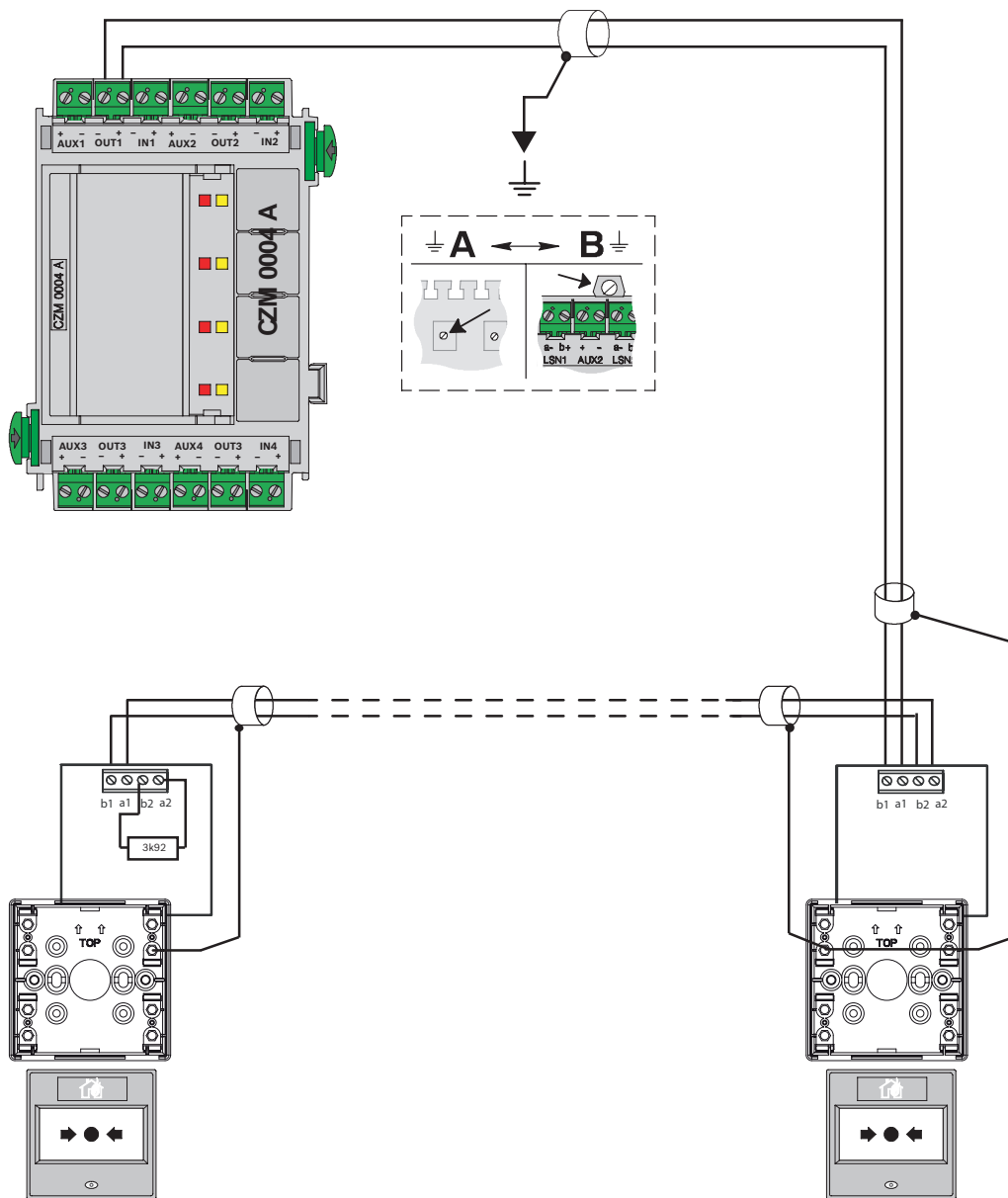
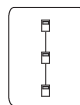

### 2.4.3 ENO 0000 A/B



AT5000 IP/GPRS

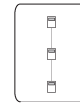

EN 54-2

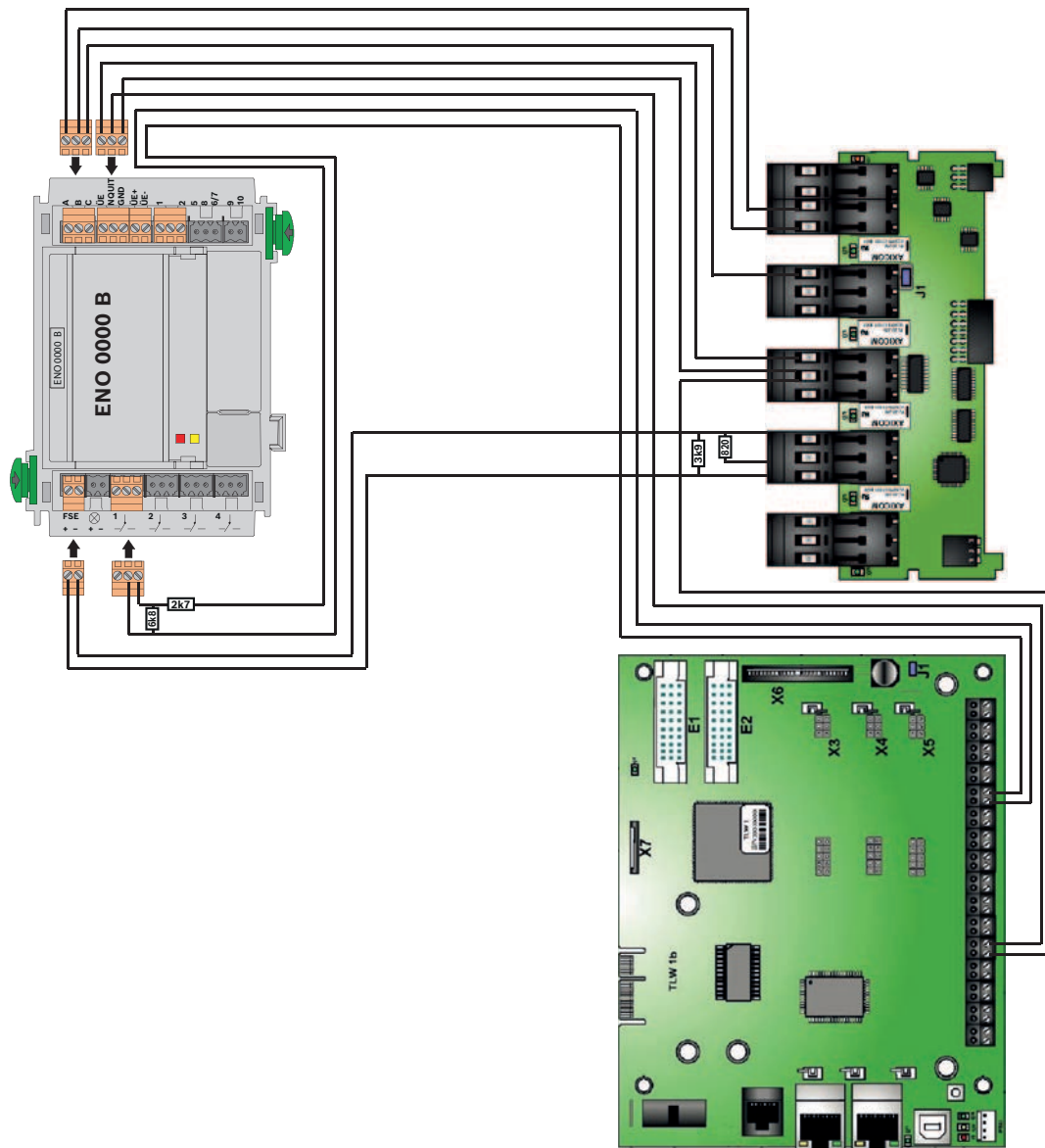

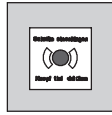
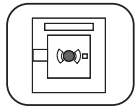

**MDL-F**

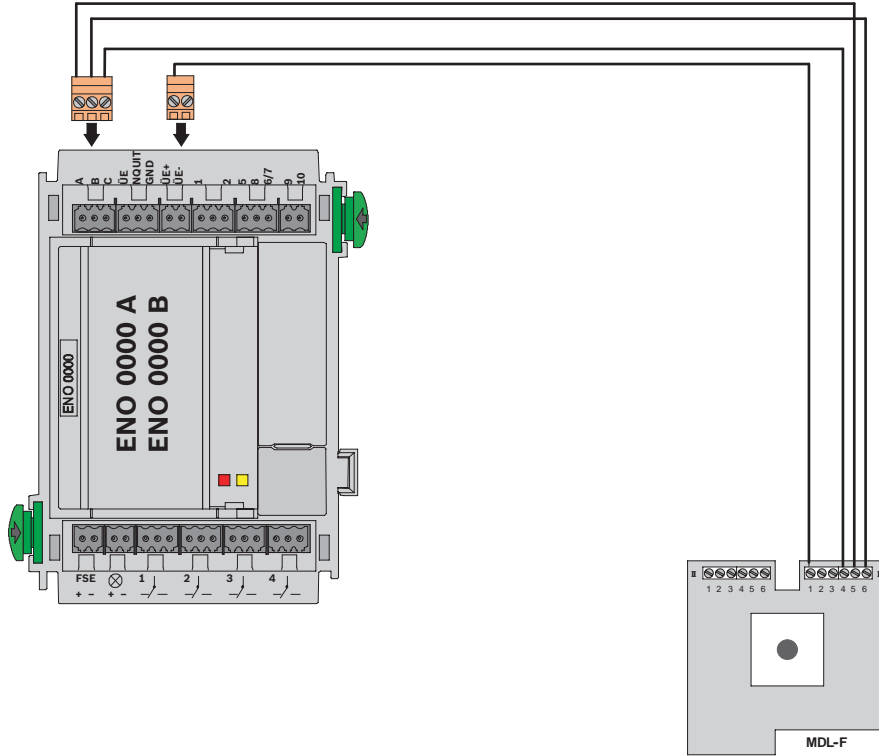

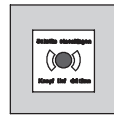
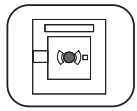

TF2F

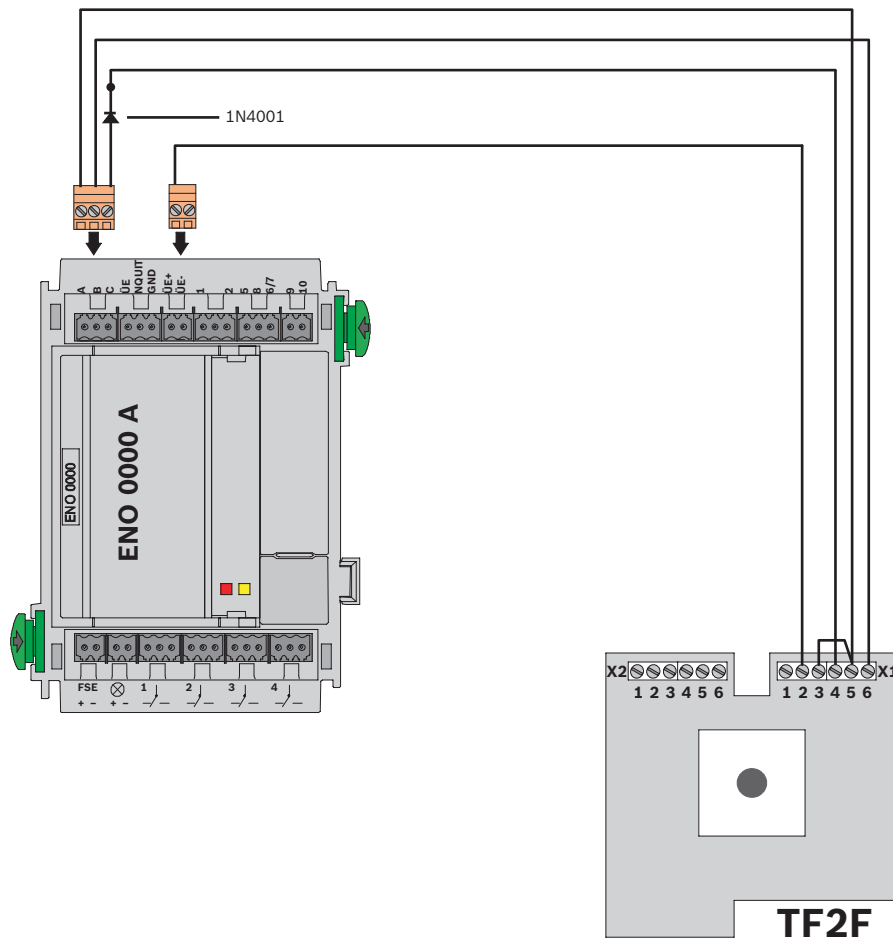
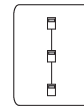

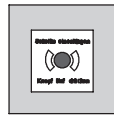
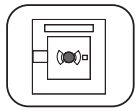

TF2F

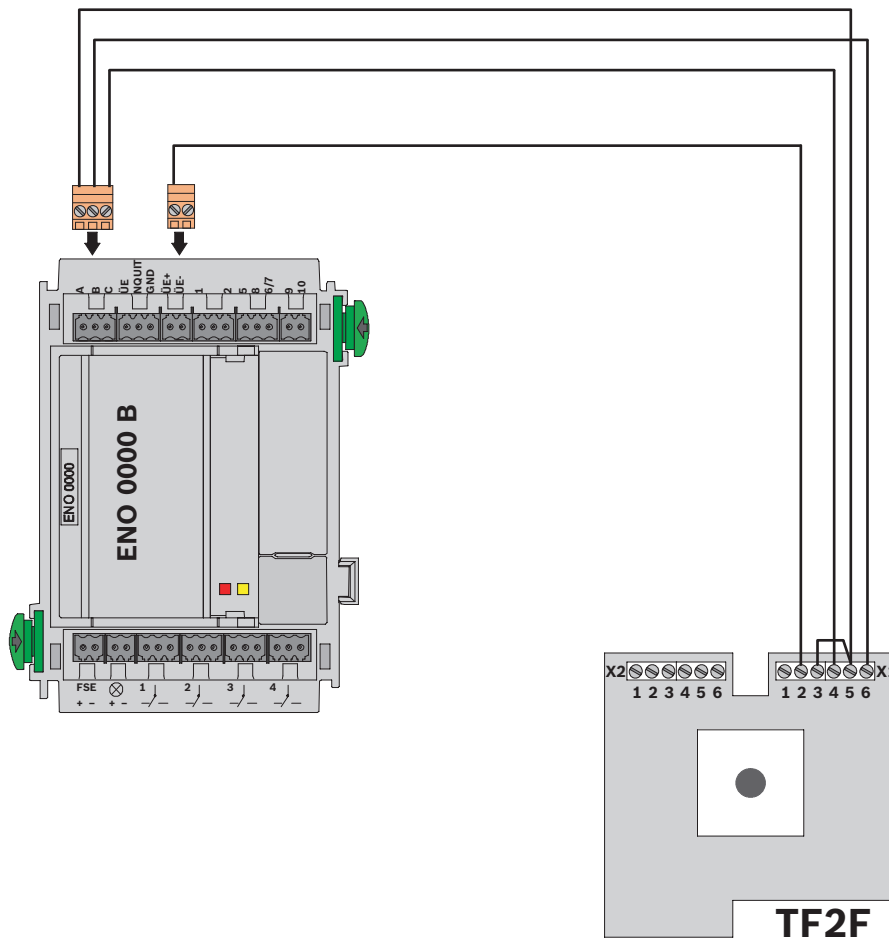
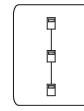

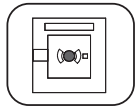

**UE-F-D/T**

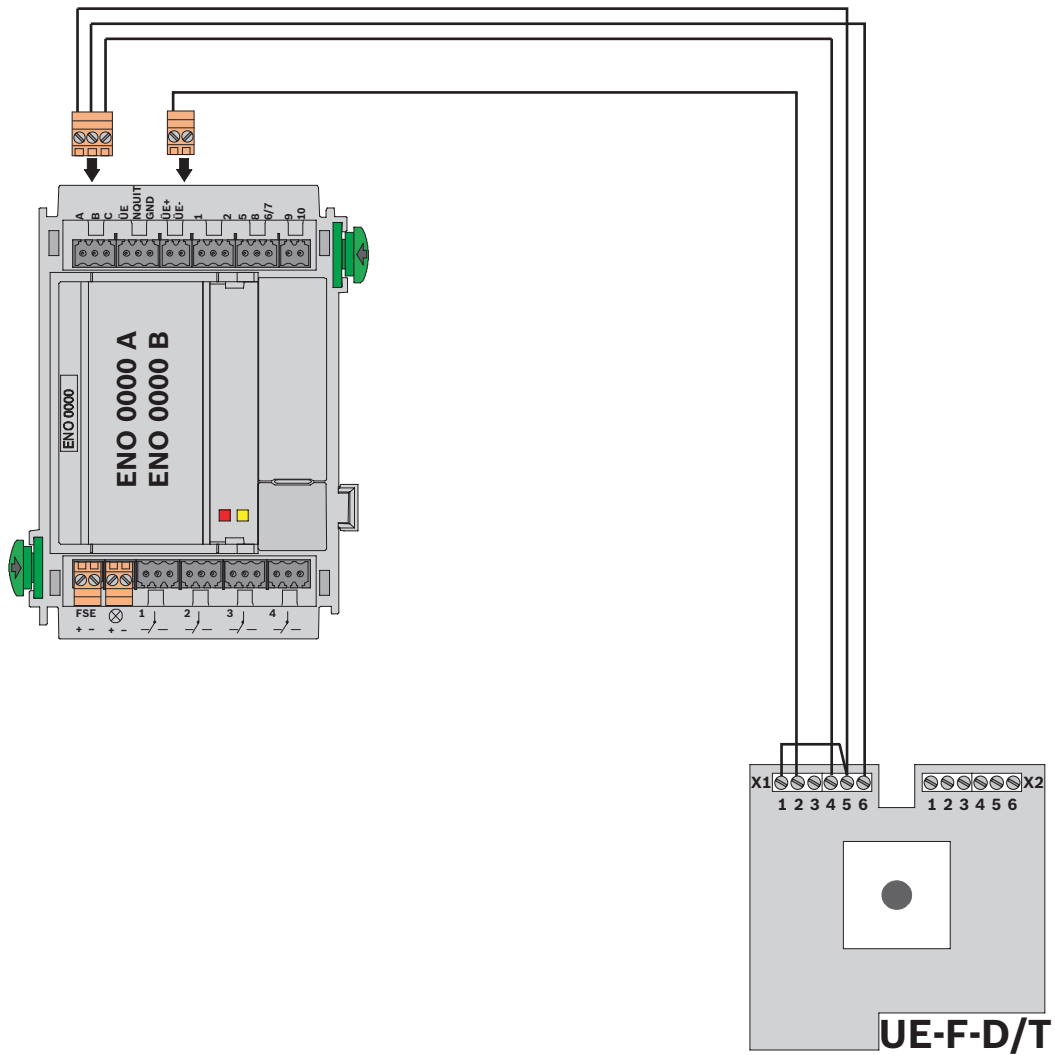

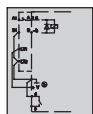

**GÜ 101-B**

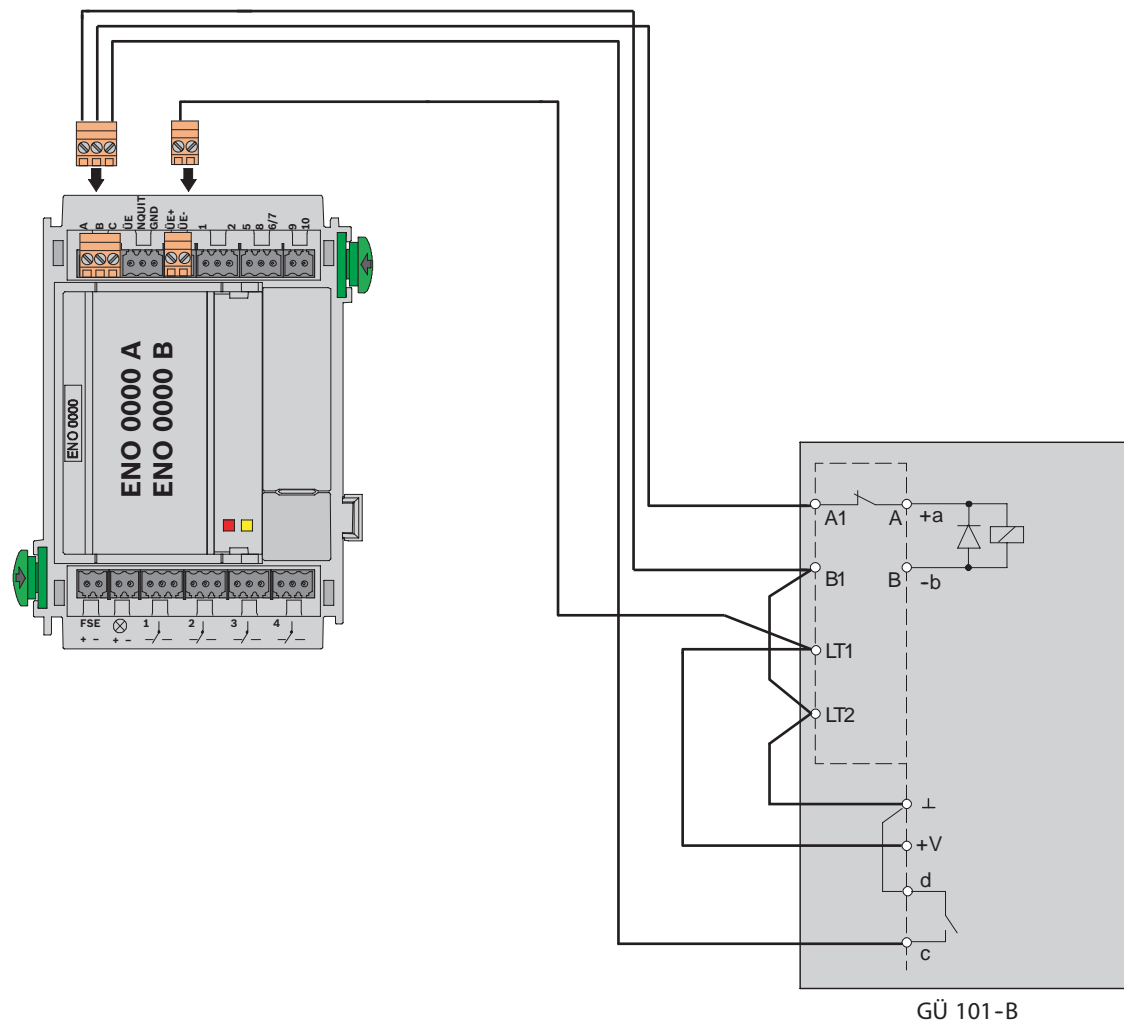
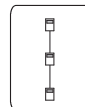



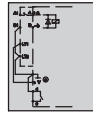

**GÜ 101-B**

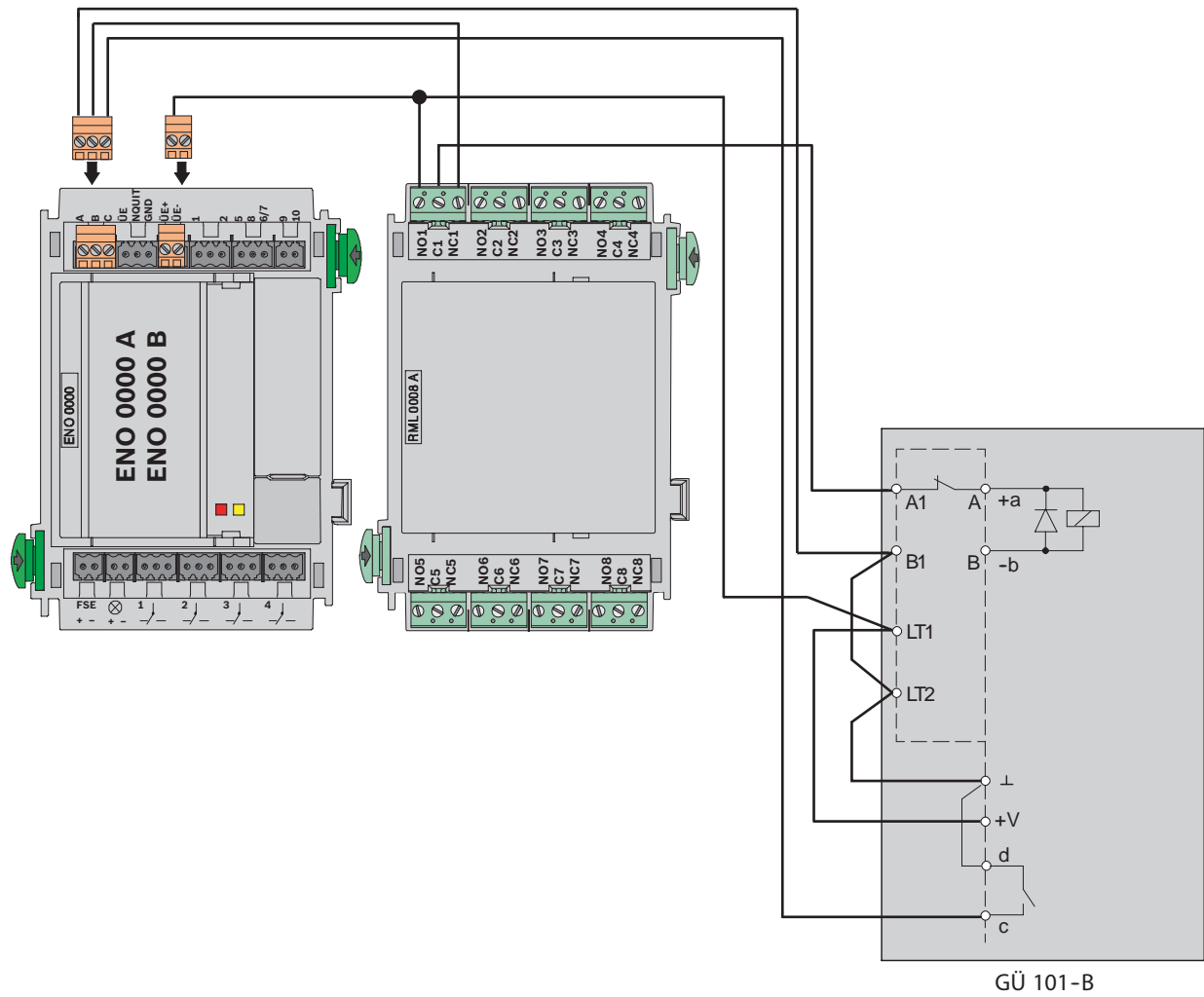
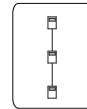

2.4.4

LSN 0300 A

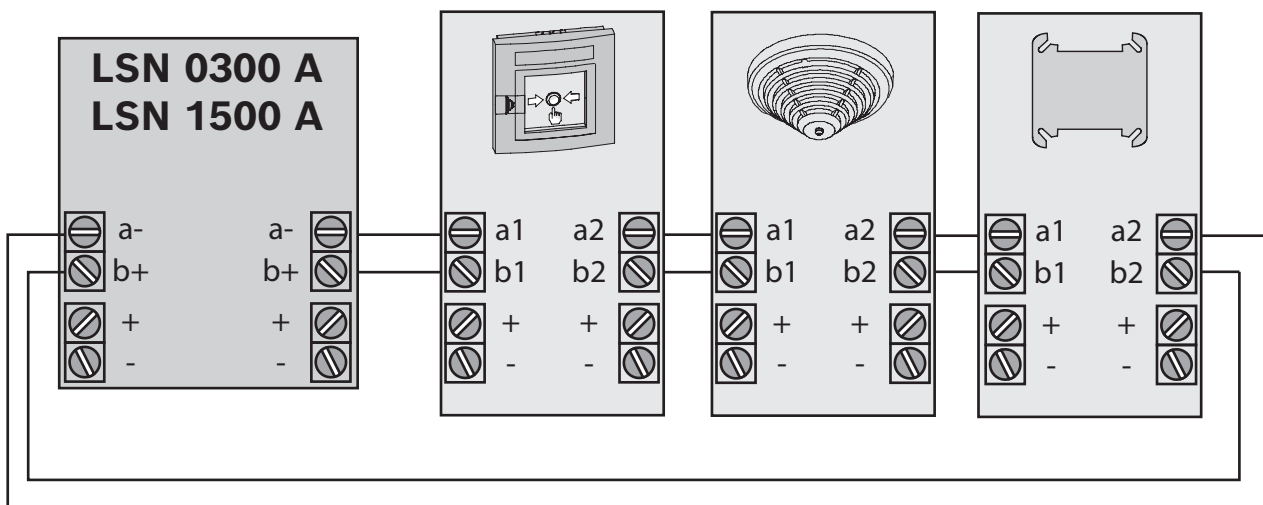
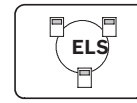

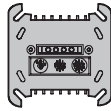
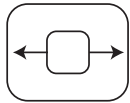

**FLM-I 420-S**  
**FLM-420-I2-D**  
**FLM-420-O1I1-D**  
**FLM-420-RHV-D/S**  
**FLM-420-RLV1-D**

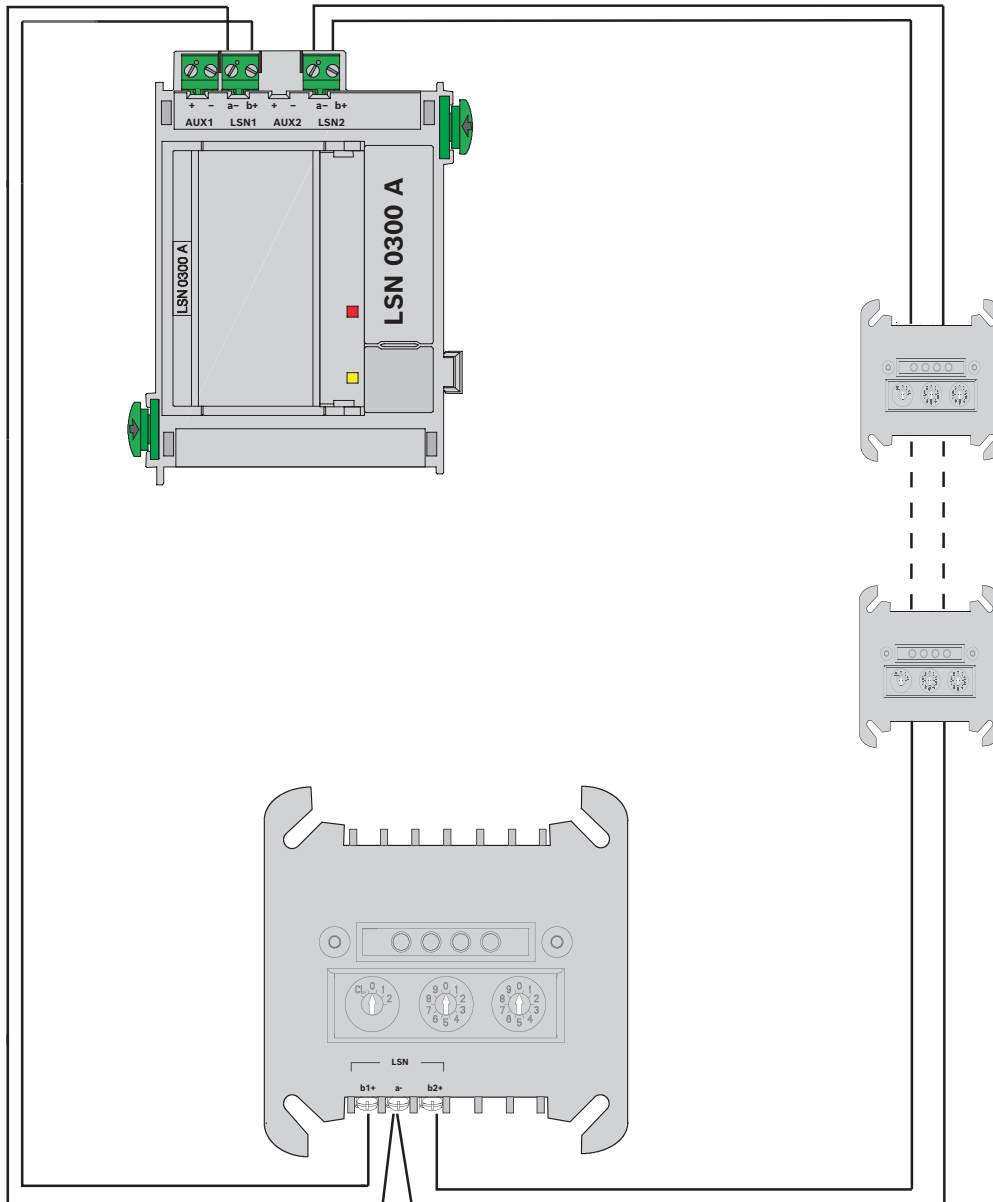
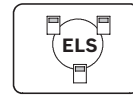

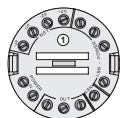
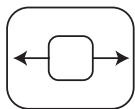

**FLM-420-12-E/W**  
**FLM-420-RLV1-E**

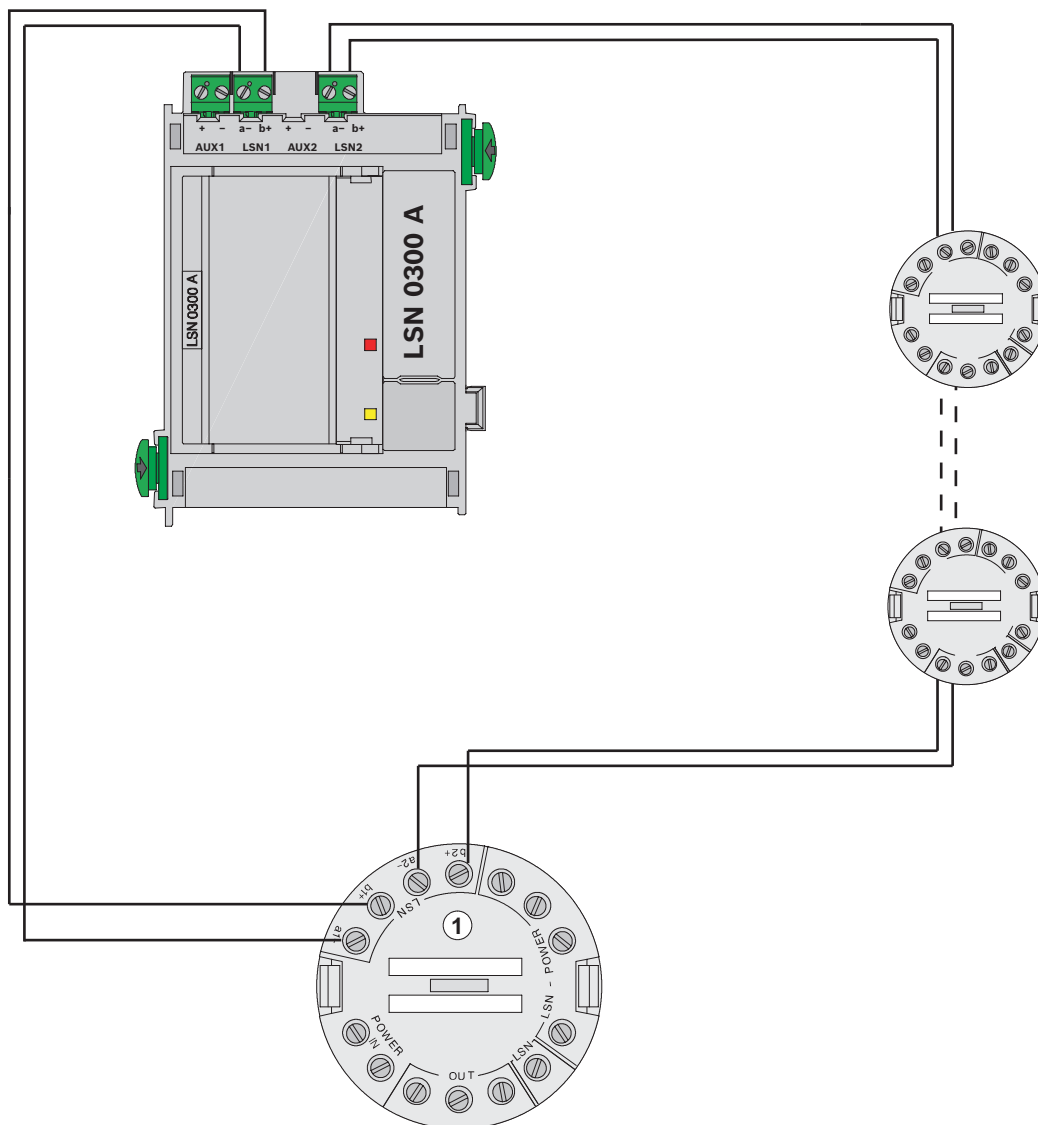
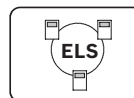

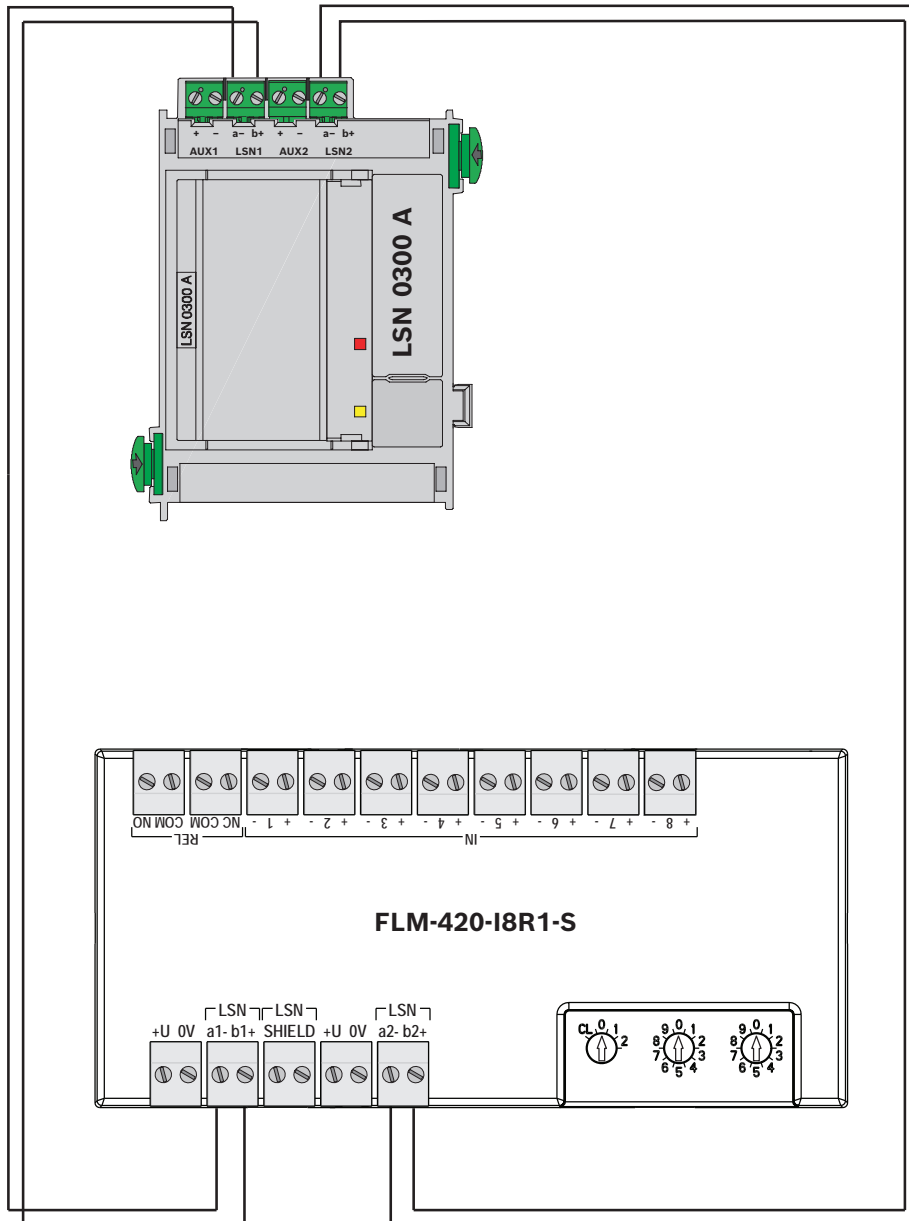
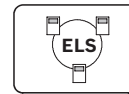
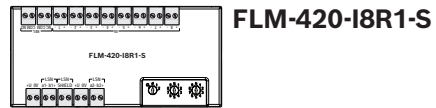
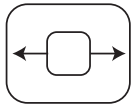

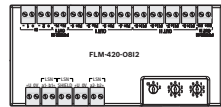
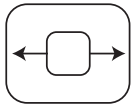

**FLM-420-0812-S**

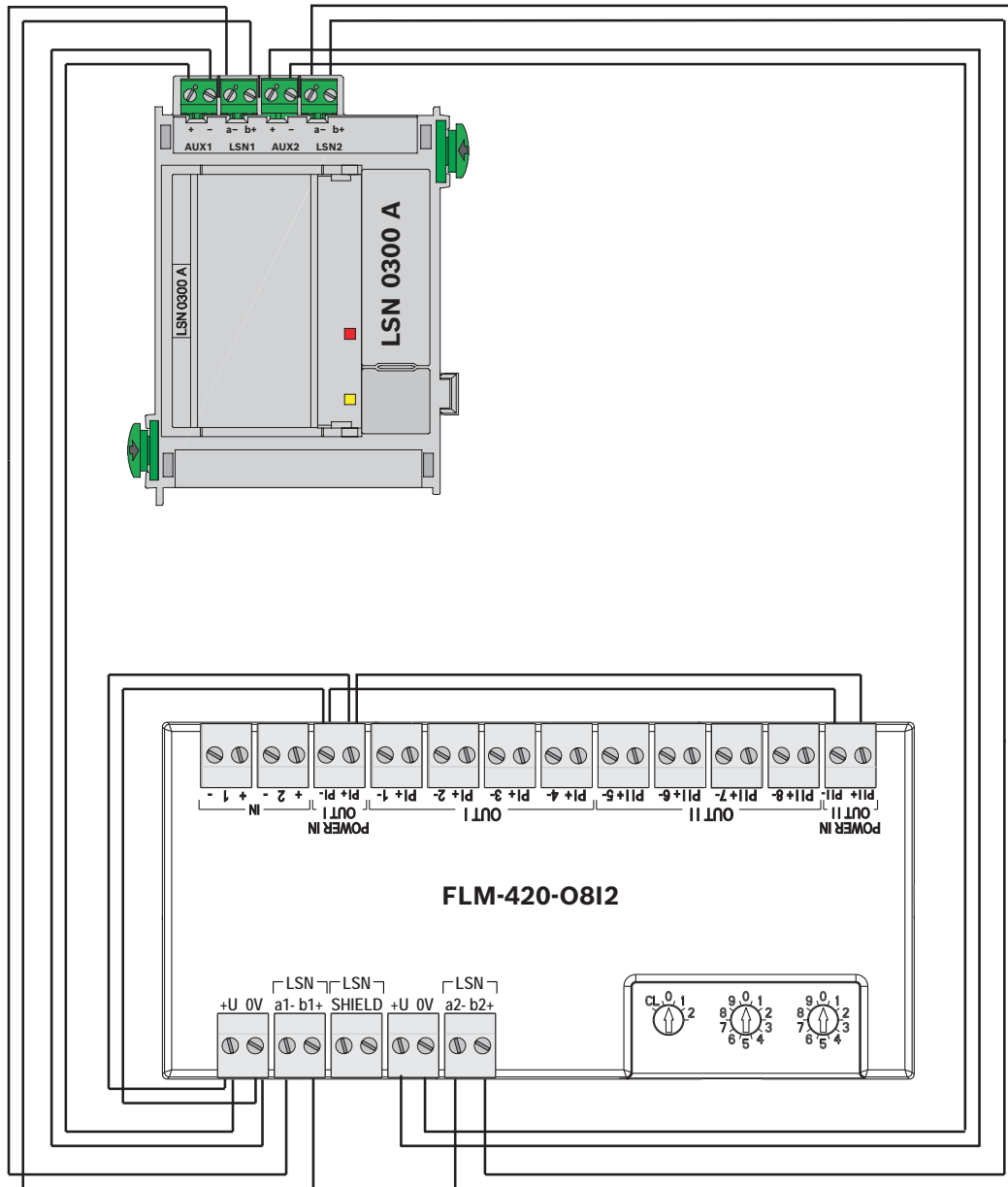
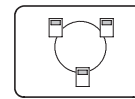

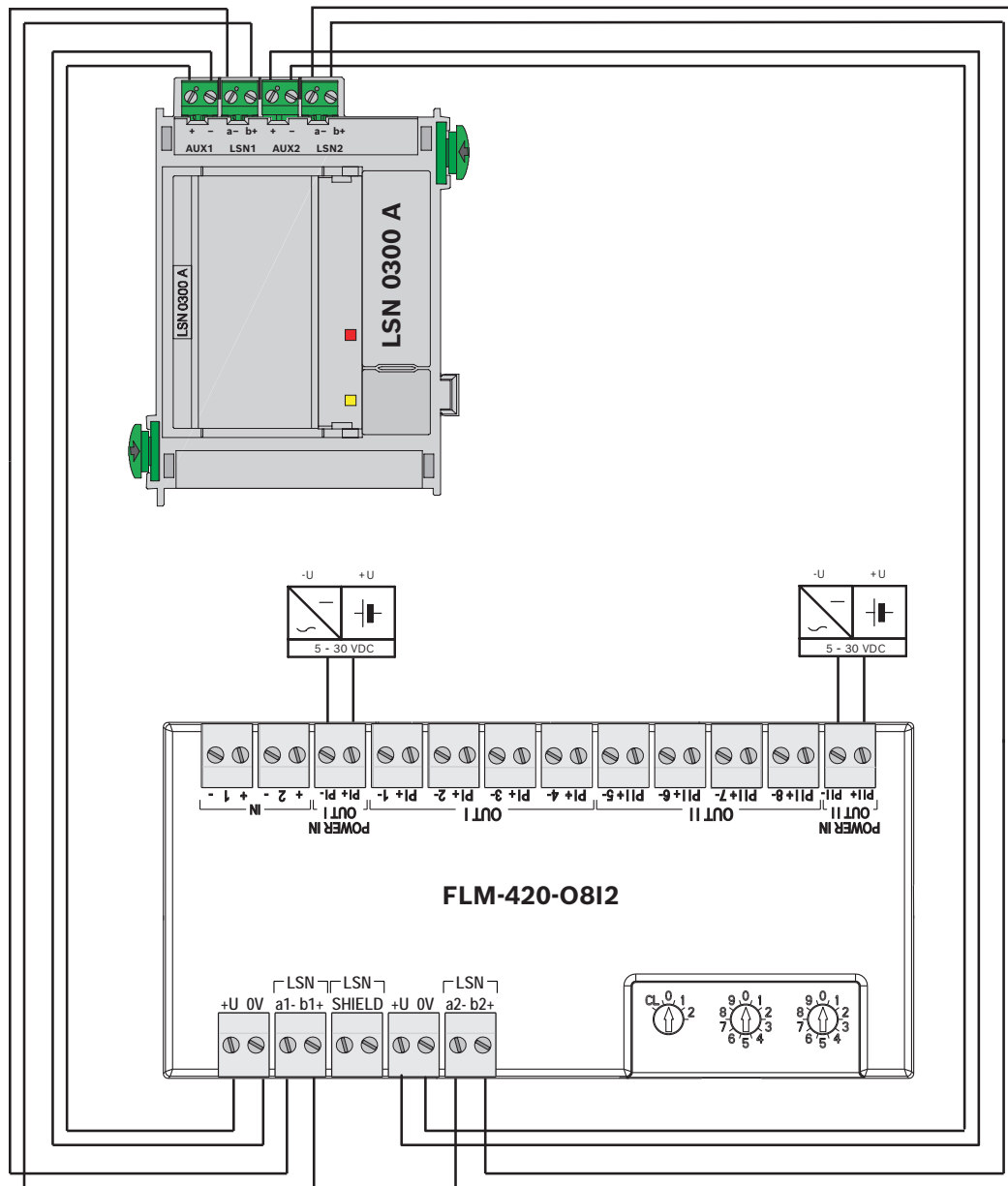
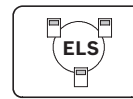
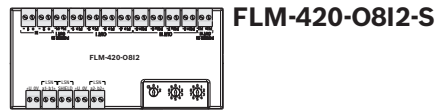
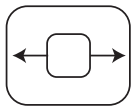

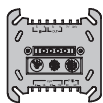
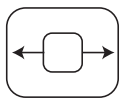

FLM-420-NAC-D/S

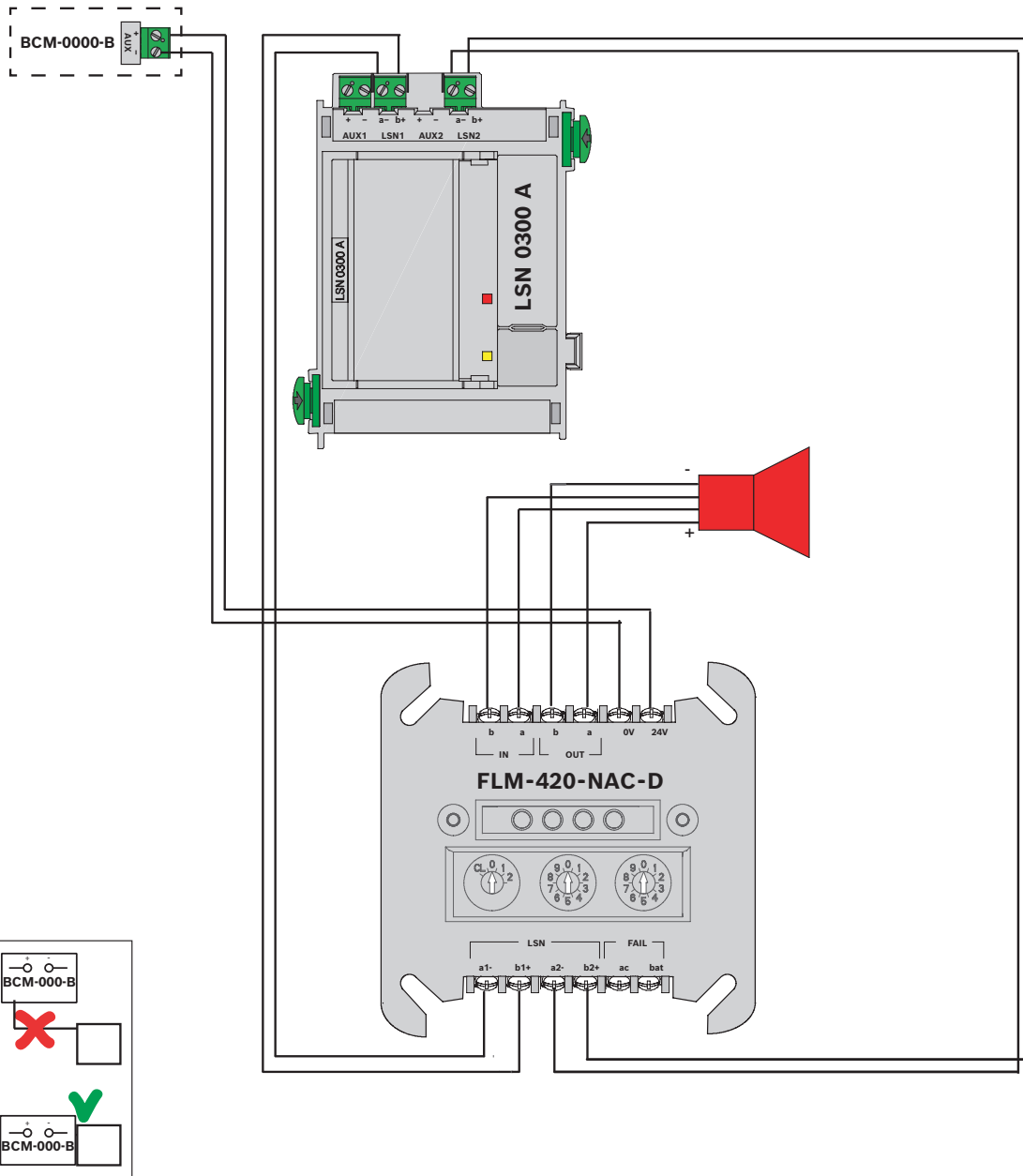
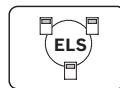



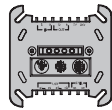
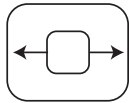

**FLM-420-NAC-D/S**

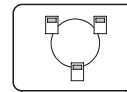

**EN 54-2**

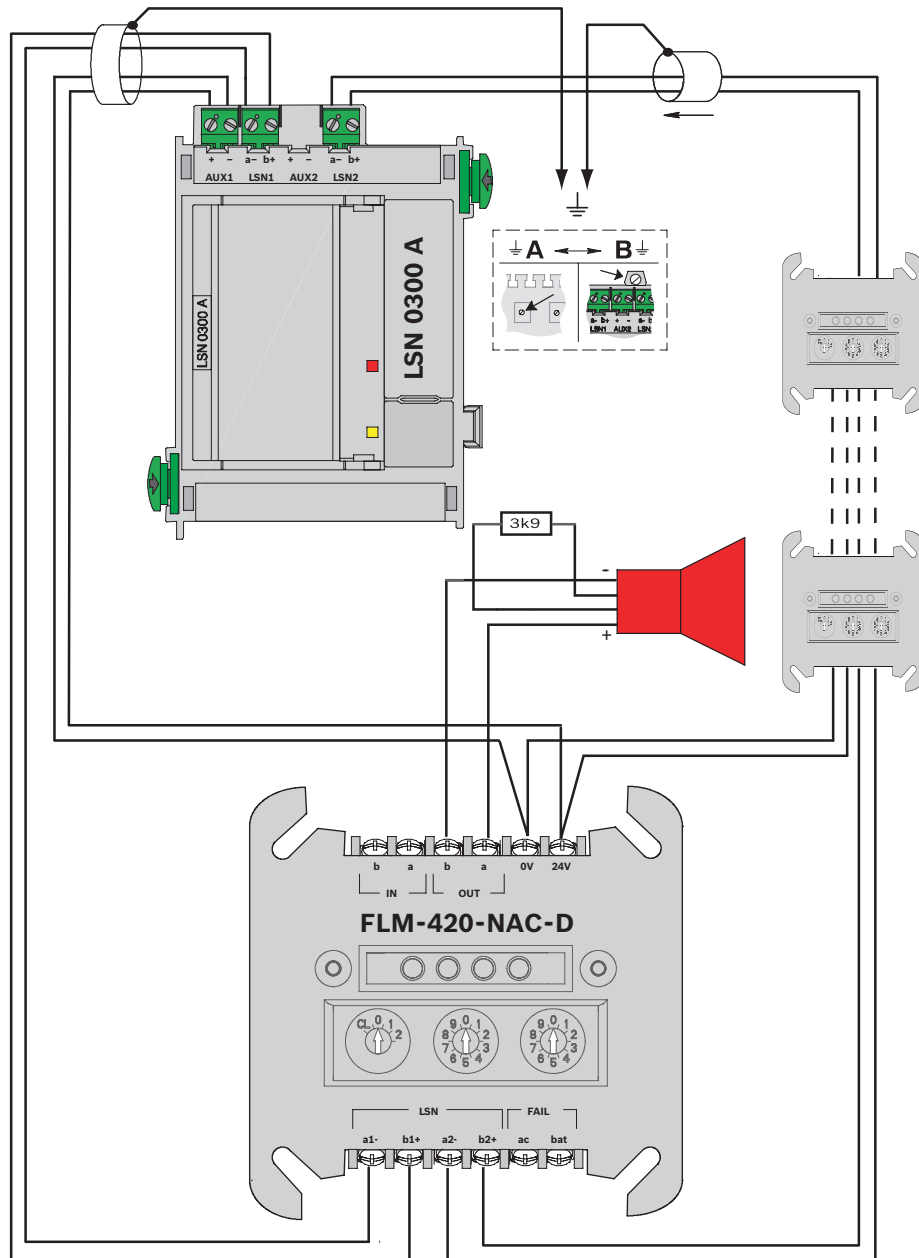

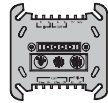
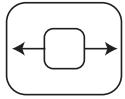

FLM-420-NAC-D/S

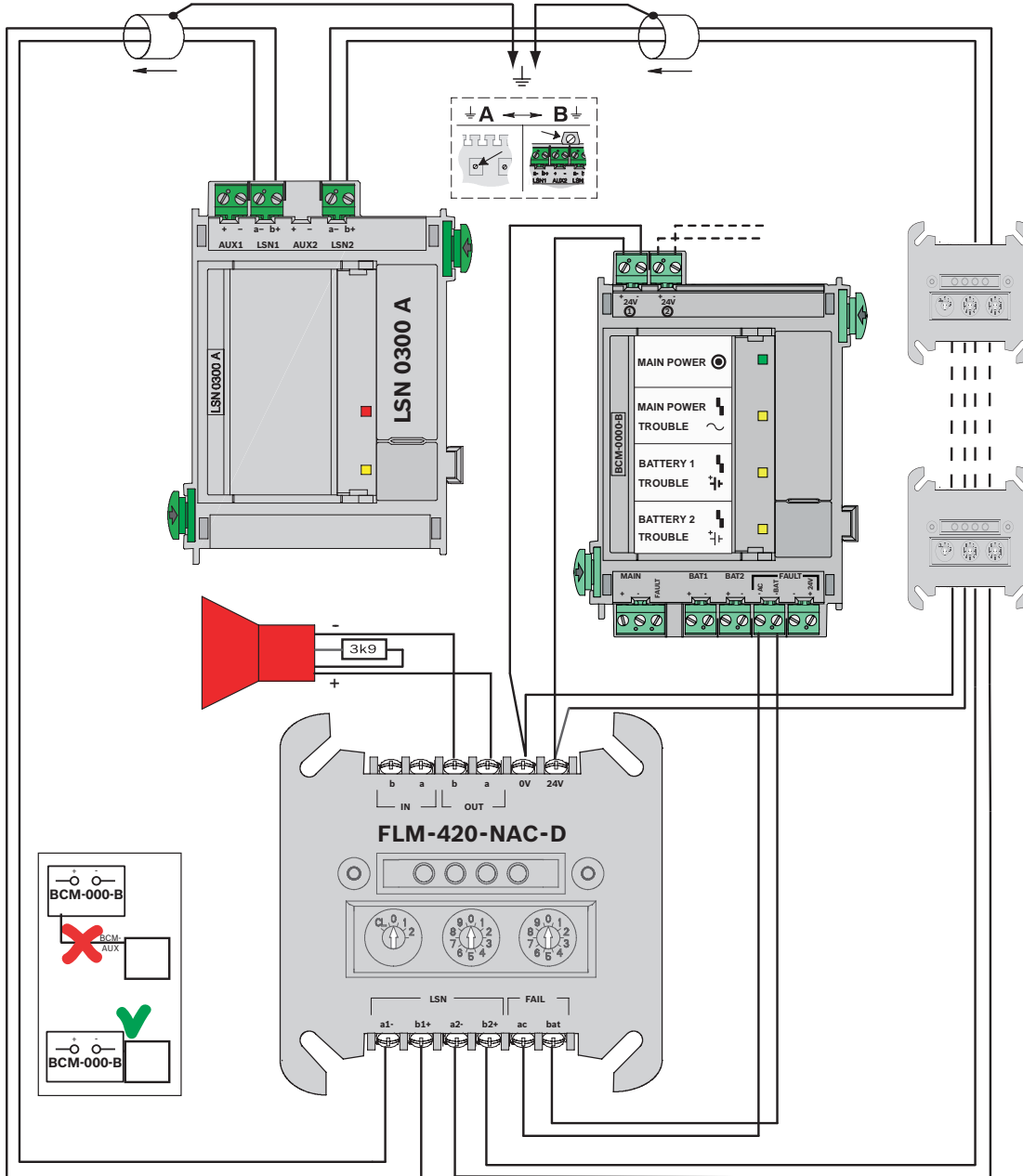
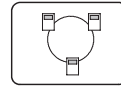

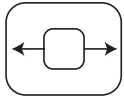

FLM-420-RLE-S

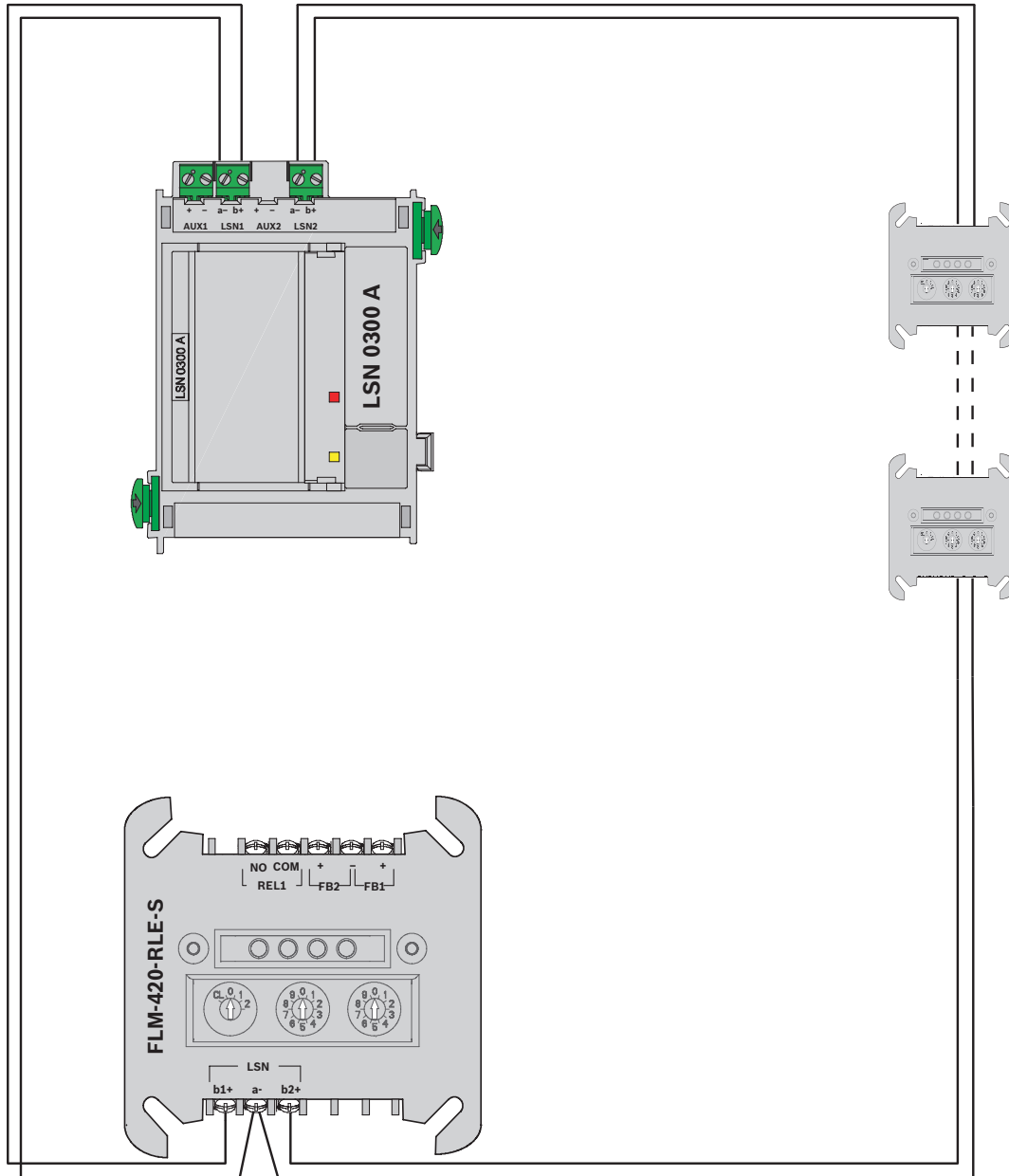
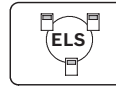

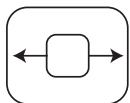

**FLM-420-O111-D**

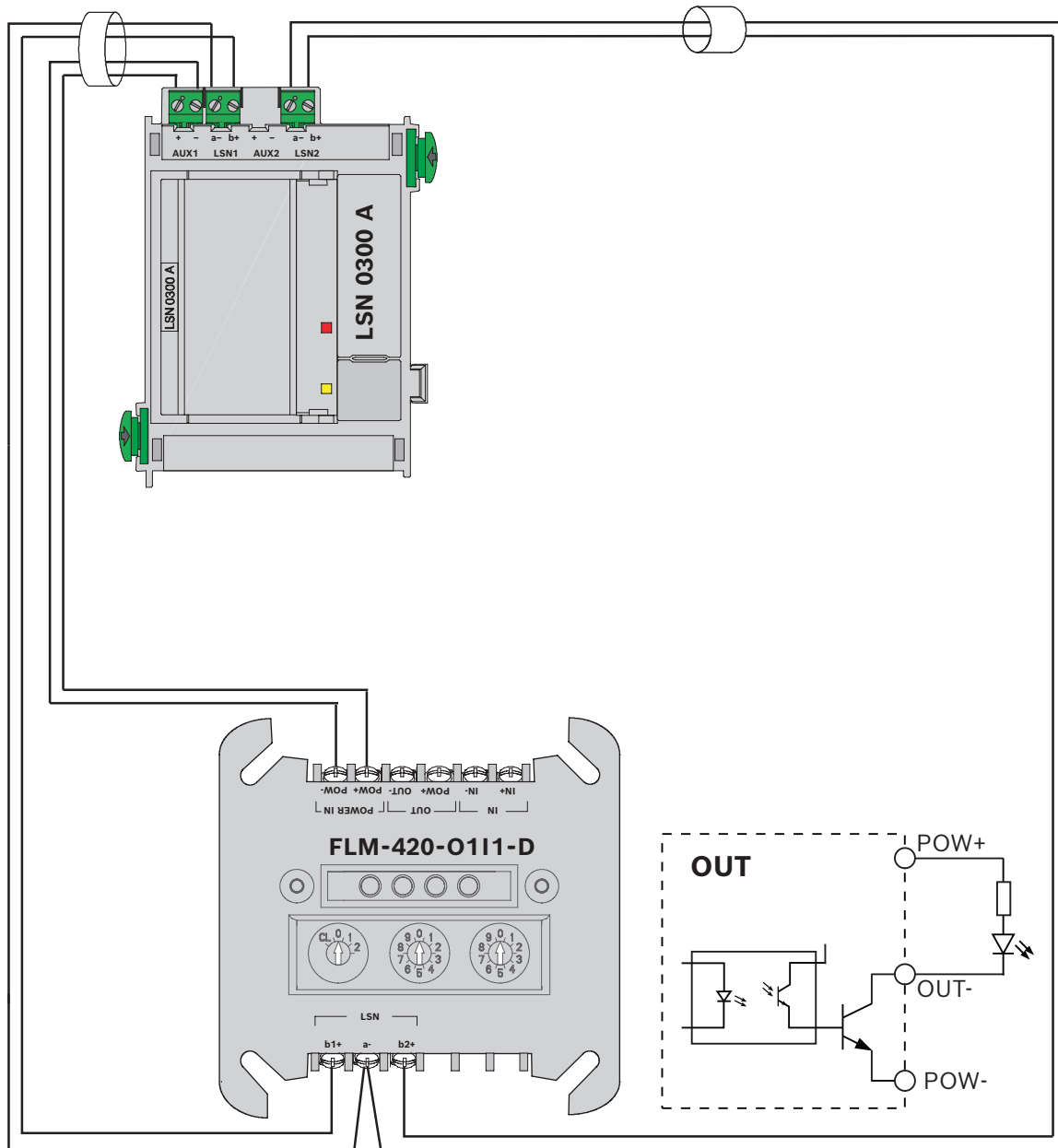
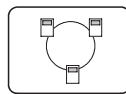

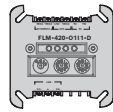
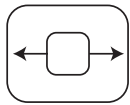

**FLM-420-O111-D**

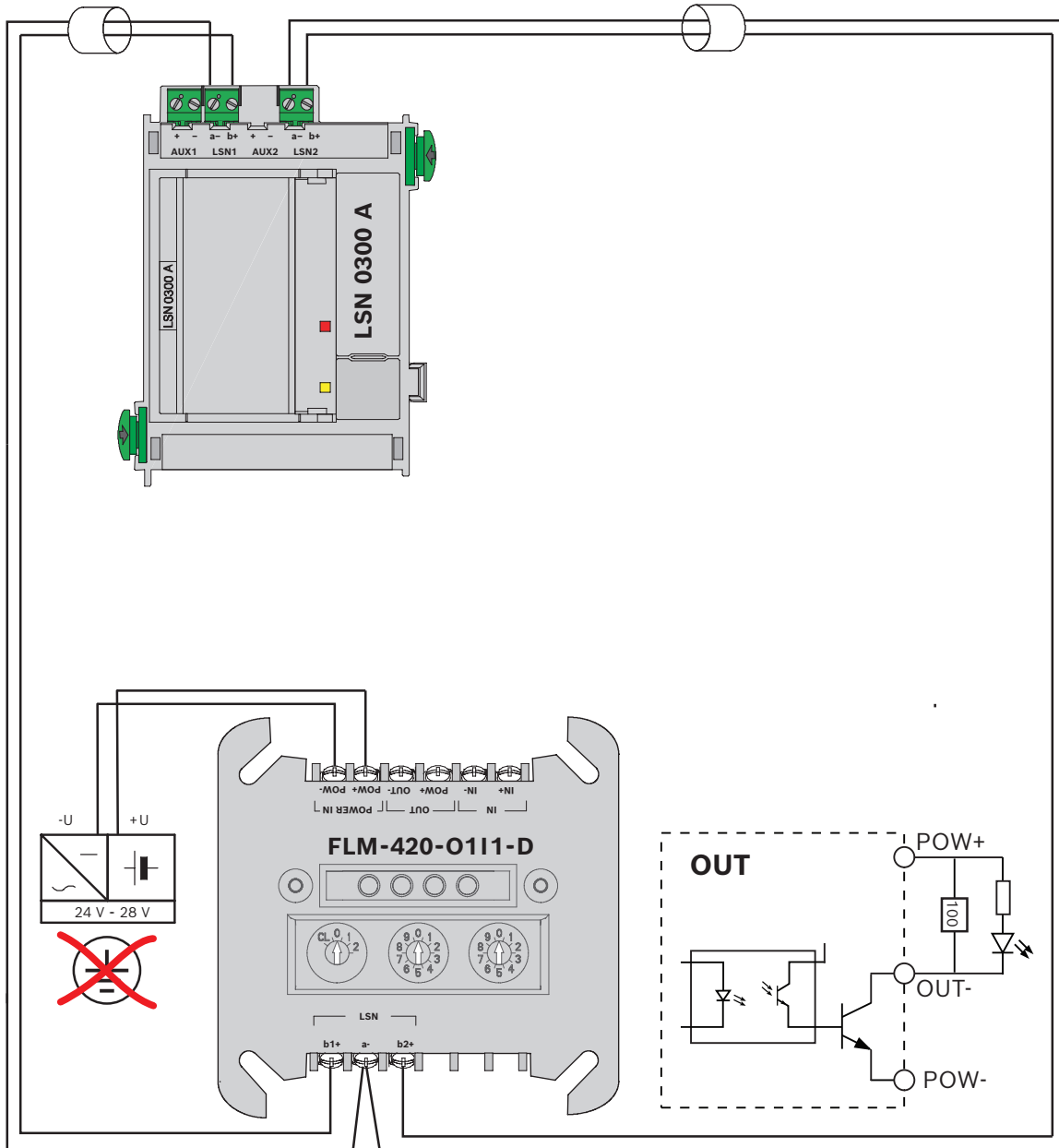
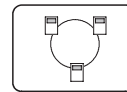

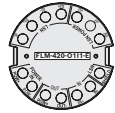
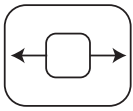

**FLM-420-O111-E**

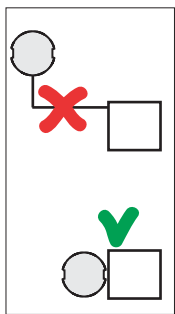
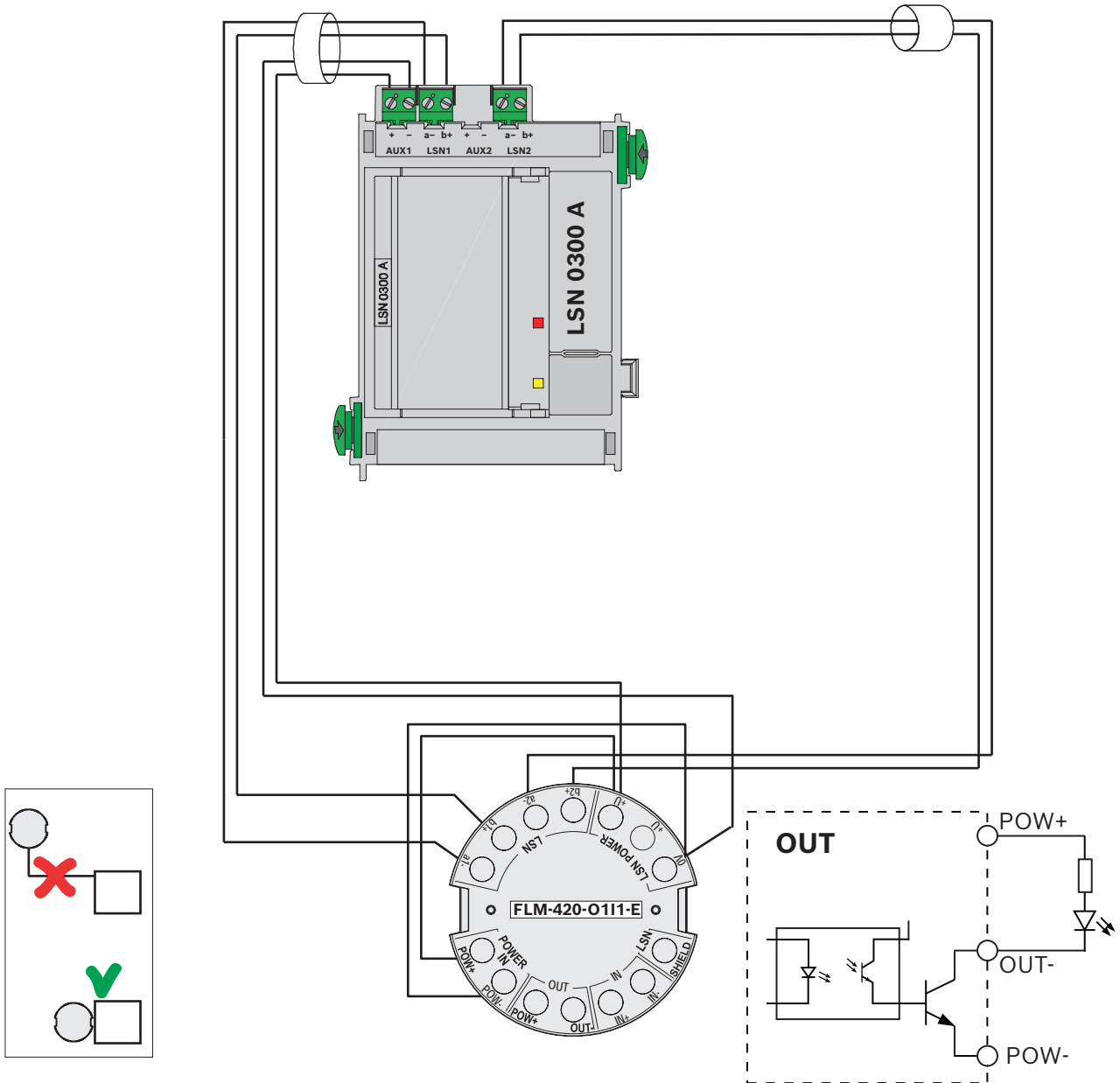
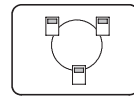

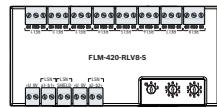
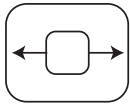

**FLM-420-RLV8-S**

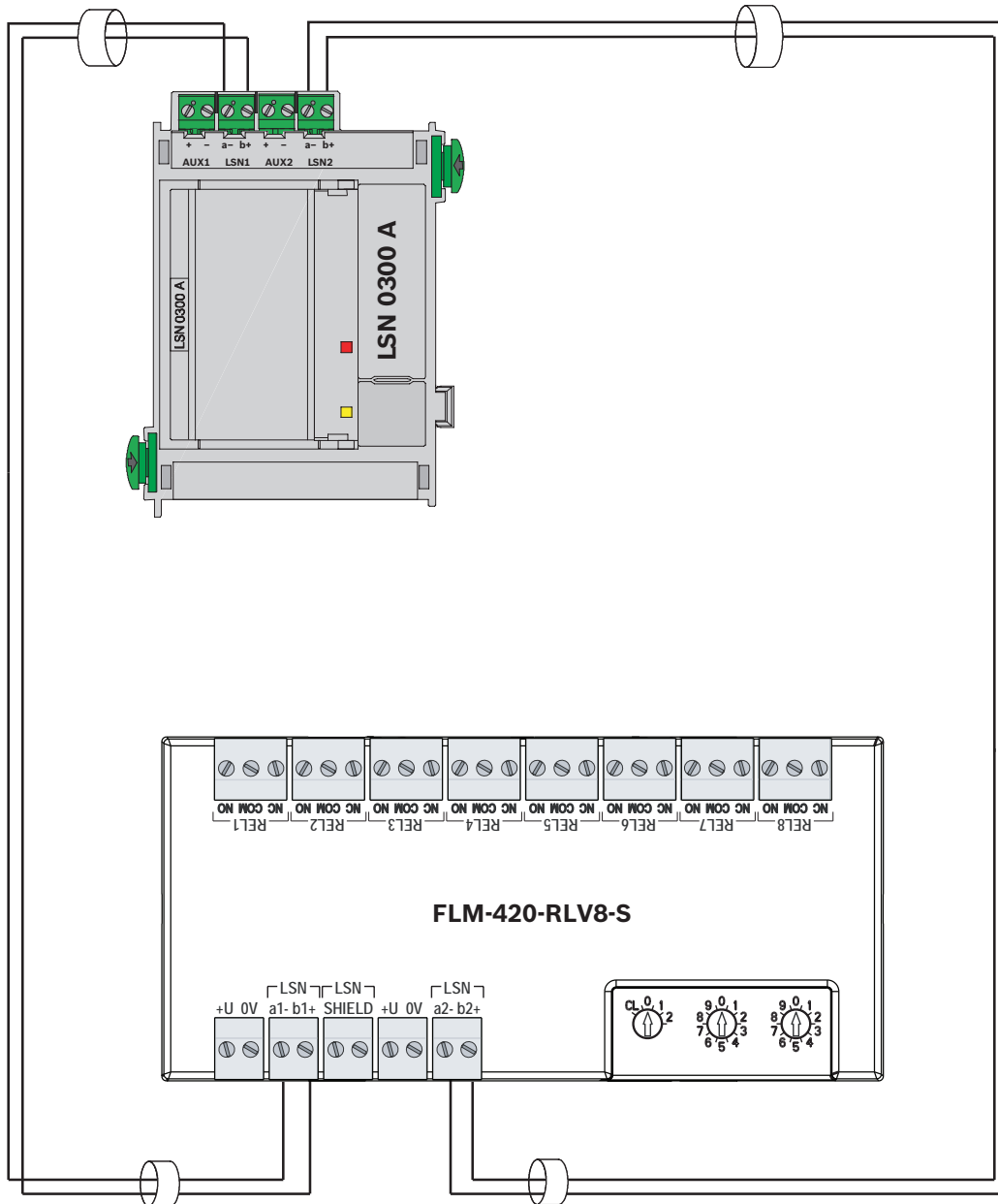
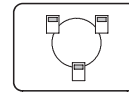



FAD-0420

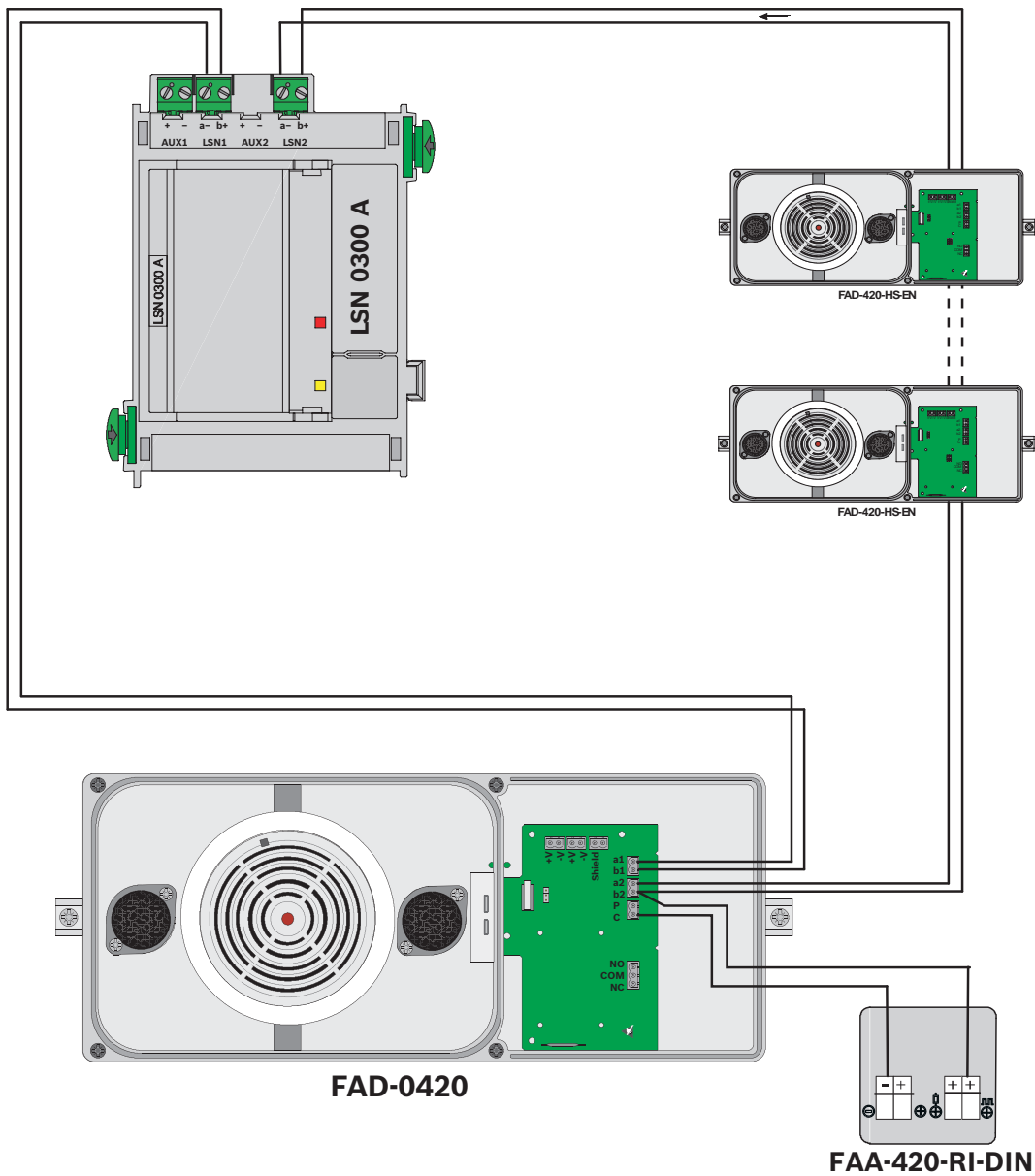





FAD-420-HS-EN

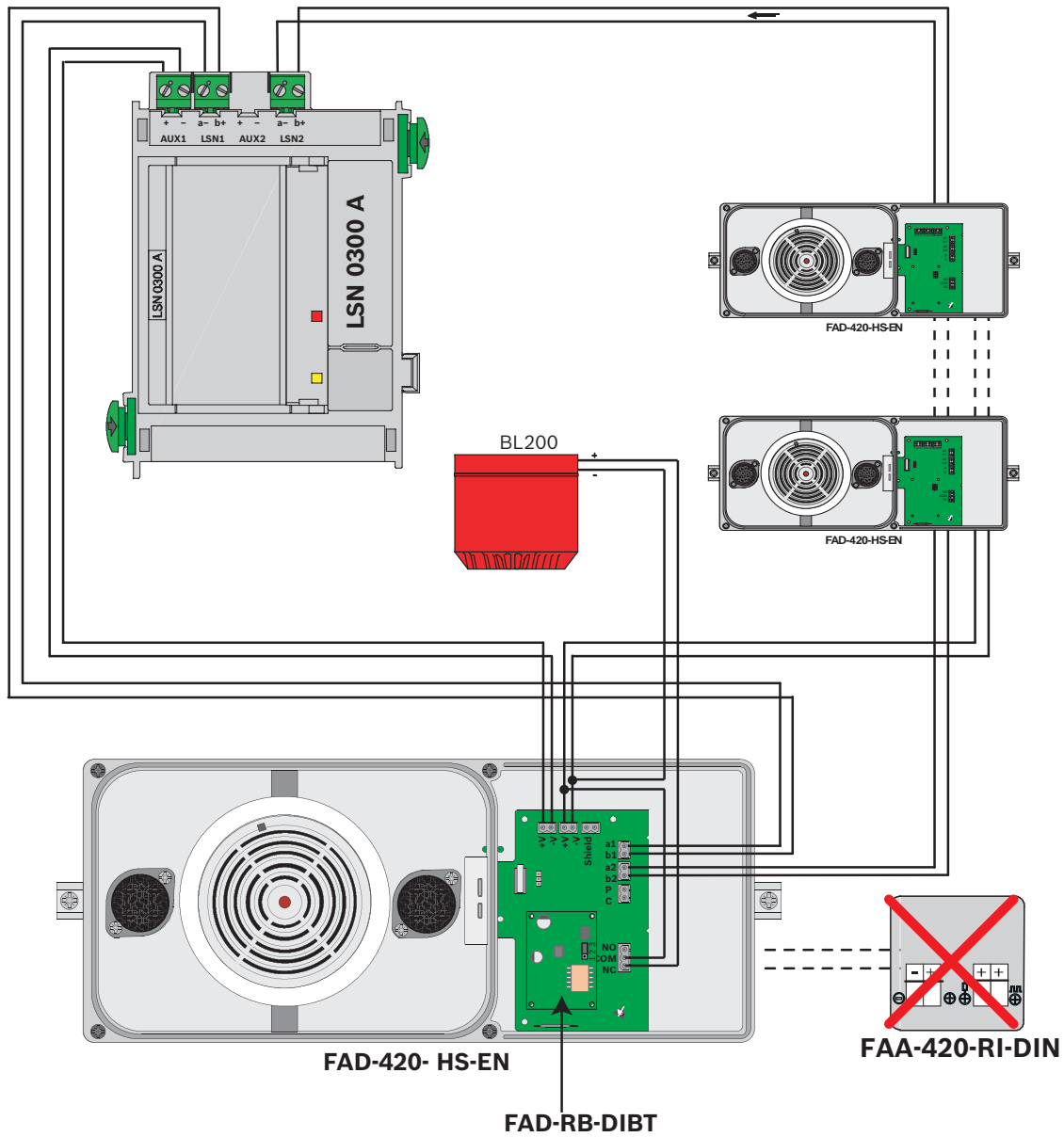

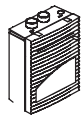

**FAS-420 Series**

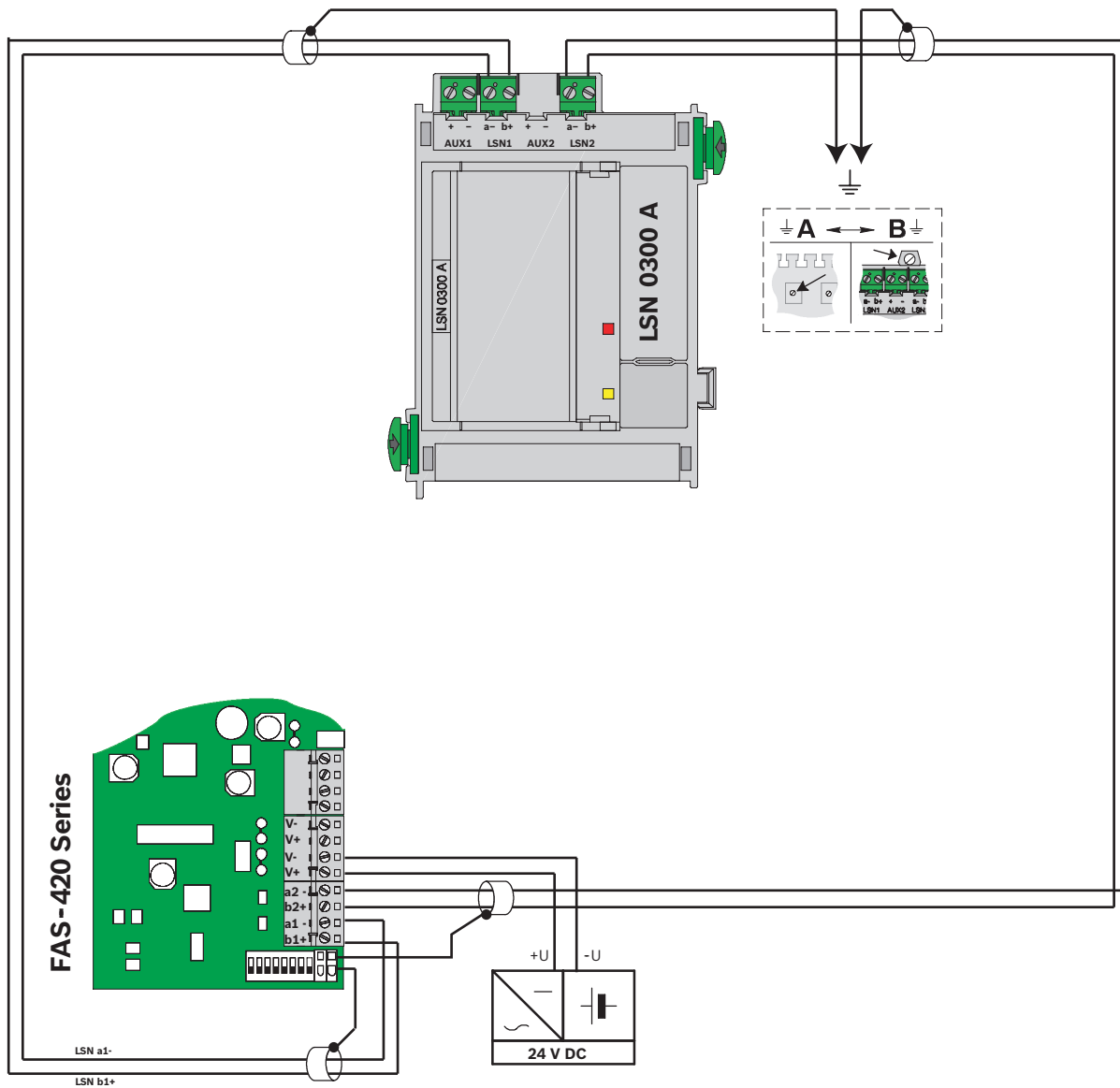

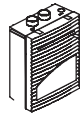

FAS-420-TM Series

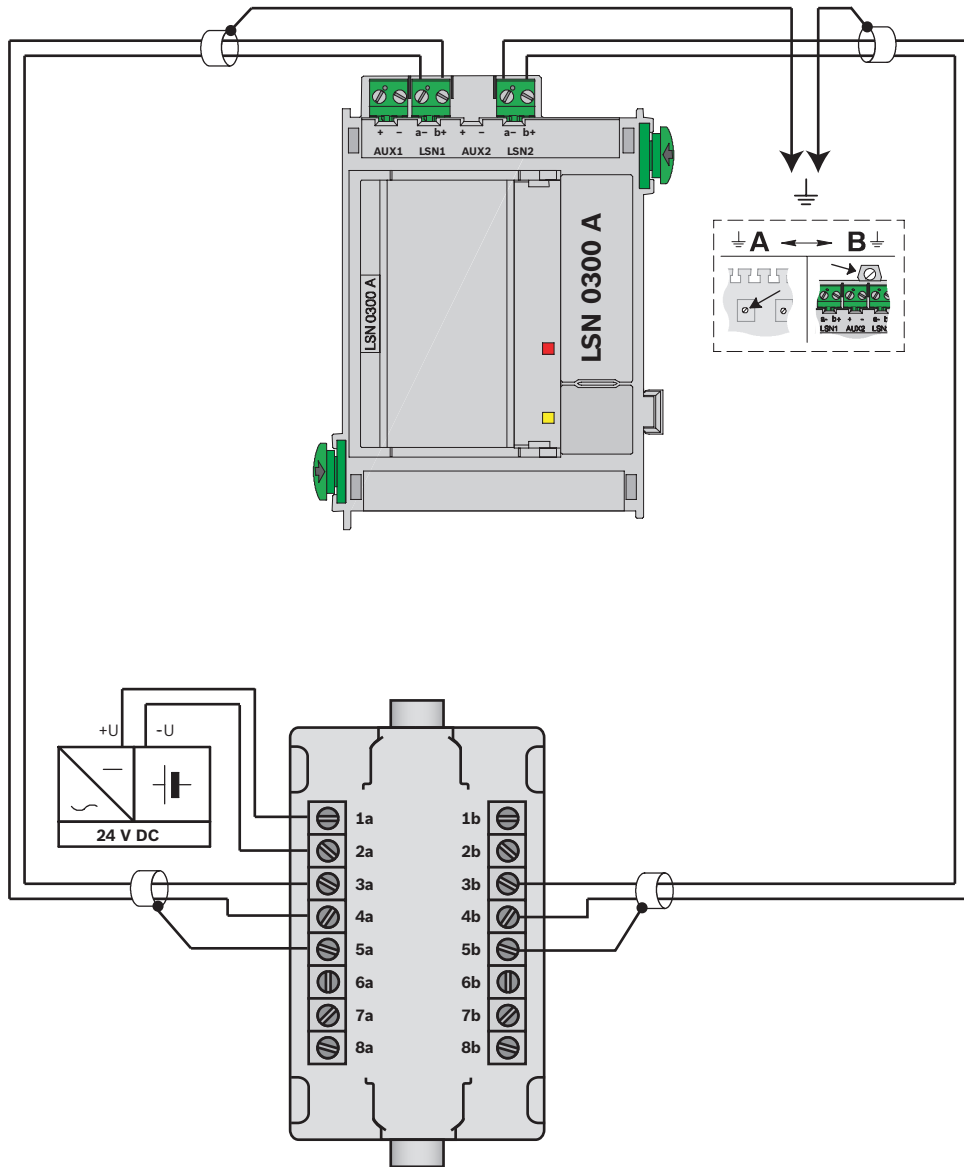

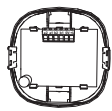

**FNM-420-A / -B**  
**FNM-420U-A / -B**  
**FNM-420V-A**

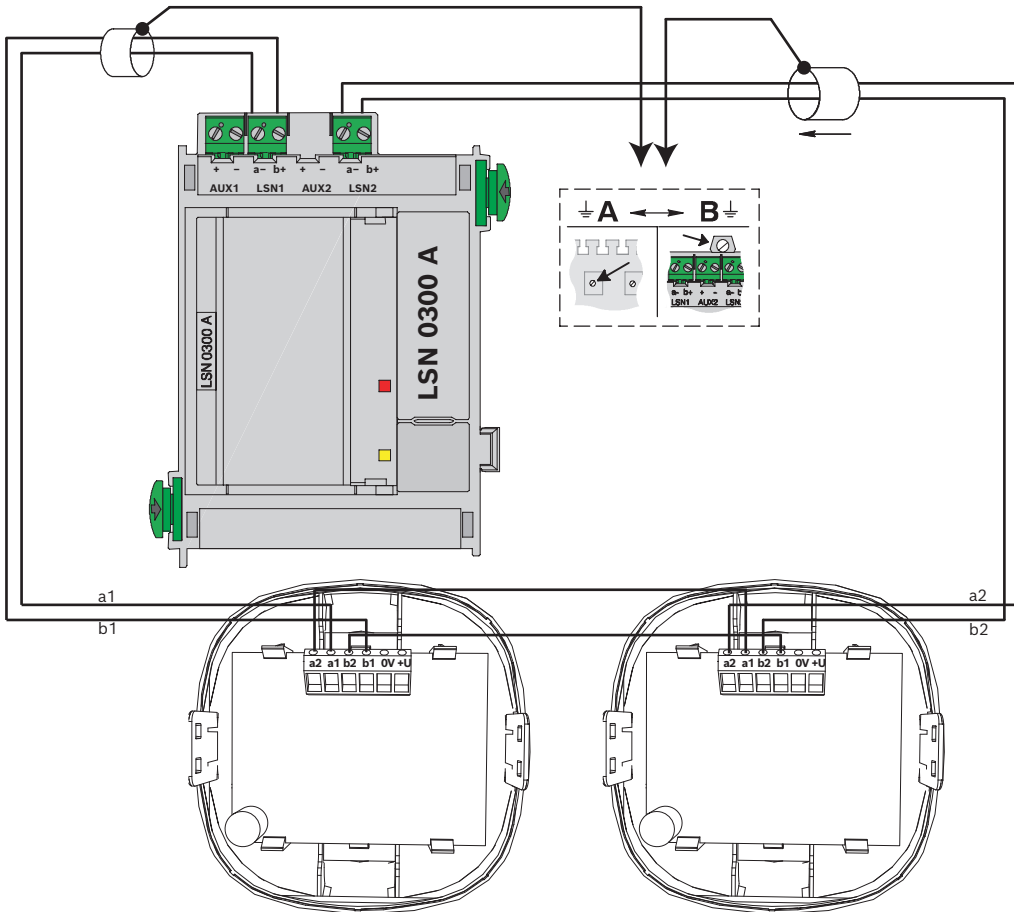
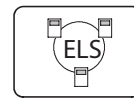

**FNM-420-A/-B**  
**FNM-420U-A/-B**  
**FNM-420V-A**

**FNM-420-A/-B**  
**FNM-420U-A/B**  
**FNM-420V-A**



**FNM-420-A-BS**  
**FNM-420U-A-BS**

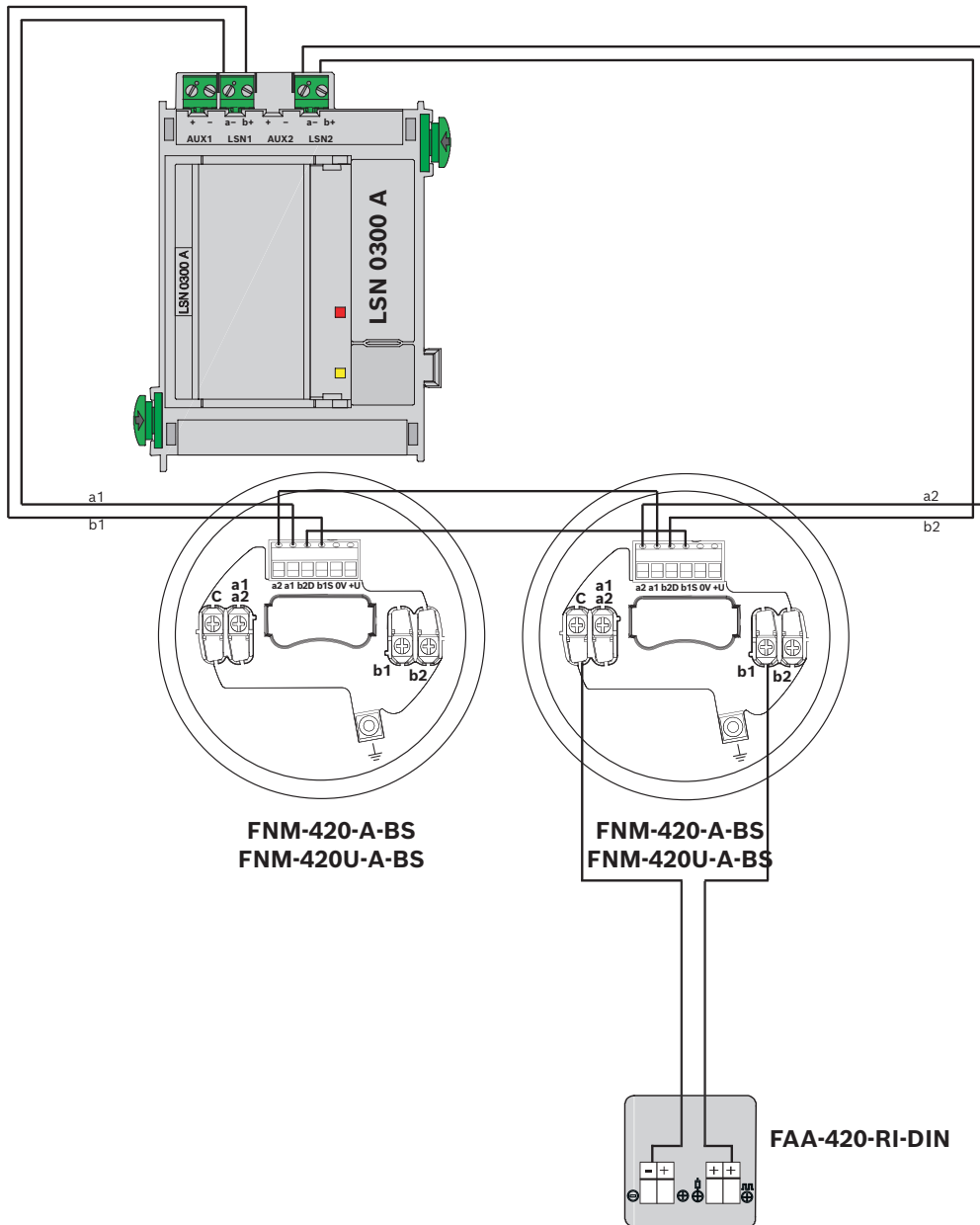
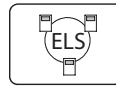

**FNM-420-A-BS**  
**FNM-420U-A-BS**

**FNM-420-A-BS**  
**FNM-420U-A-BS**

**FAA-420-RI-DIN**



**FNM-420-A-BS**  
**FNM-420U-A-BS**

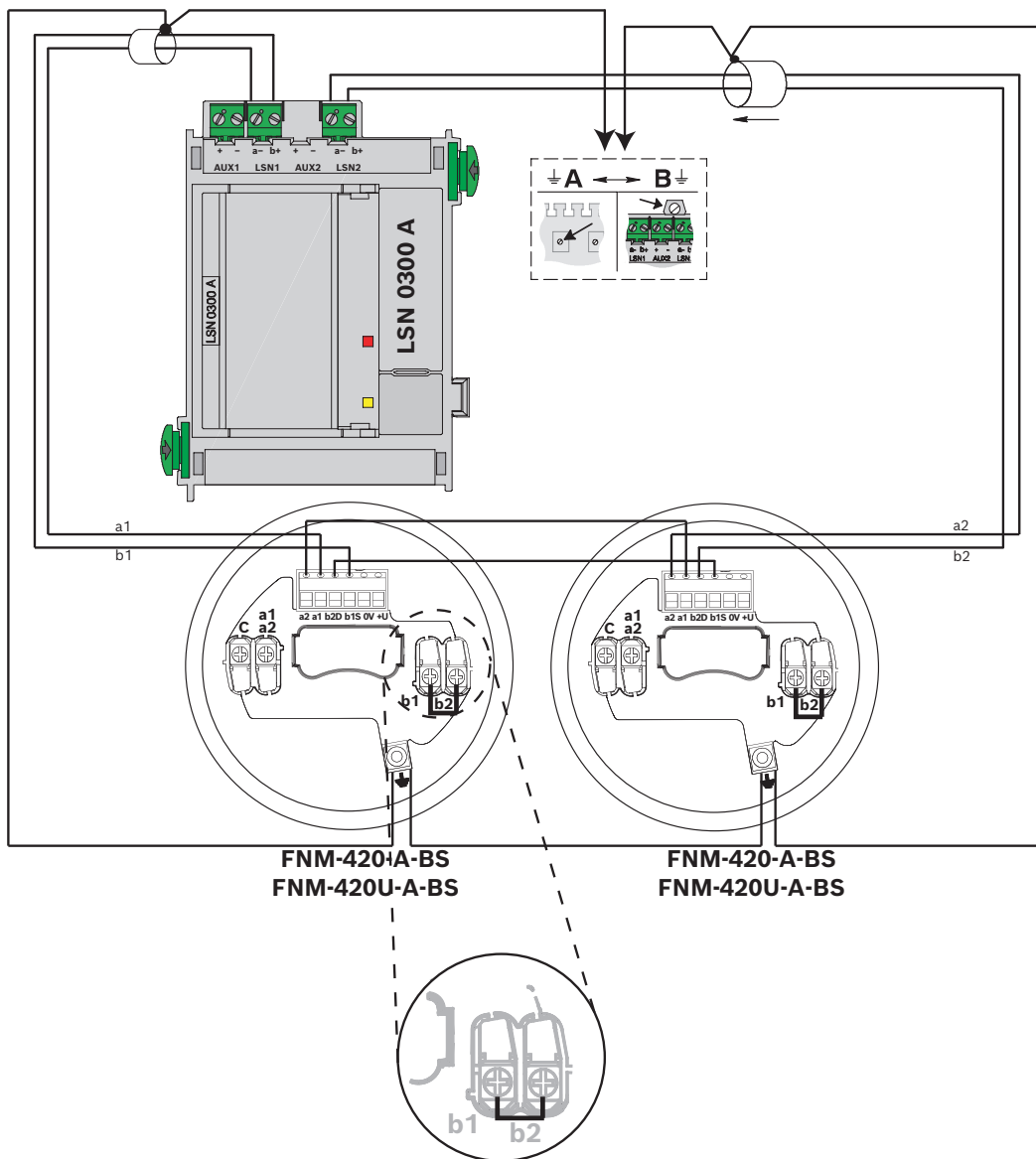
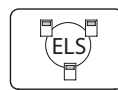

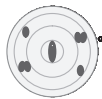

FAP-0520  
FAP-0520-P  
FAP-OC520  
FAP-OC-520-P

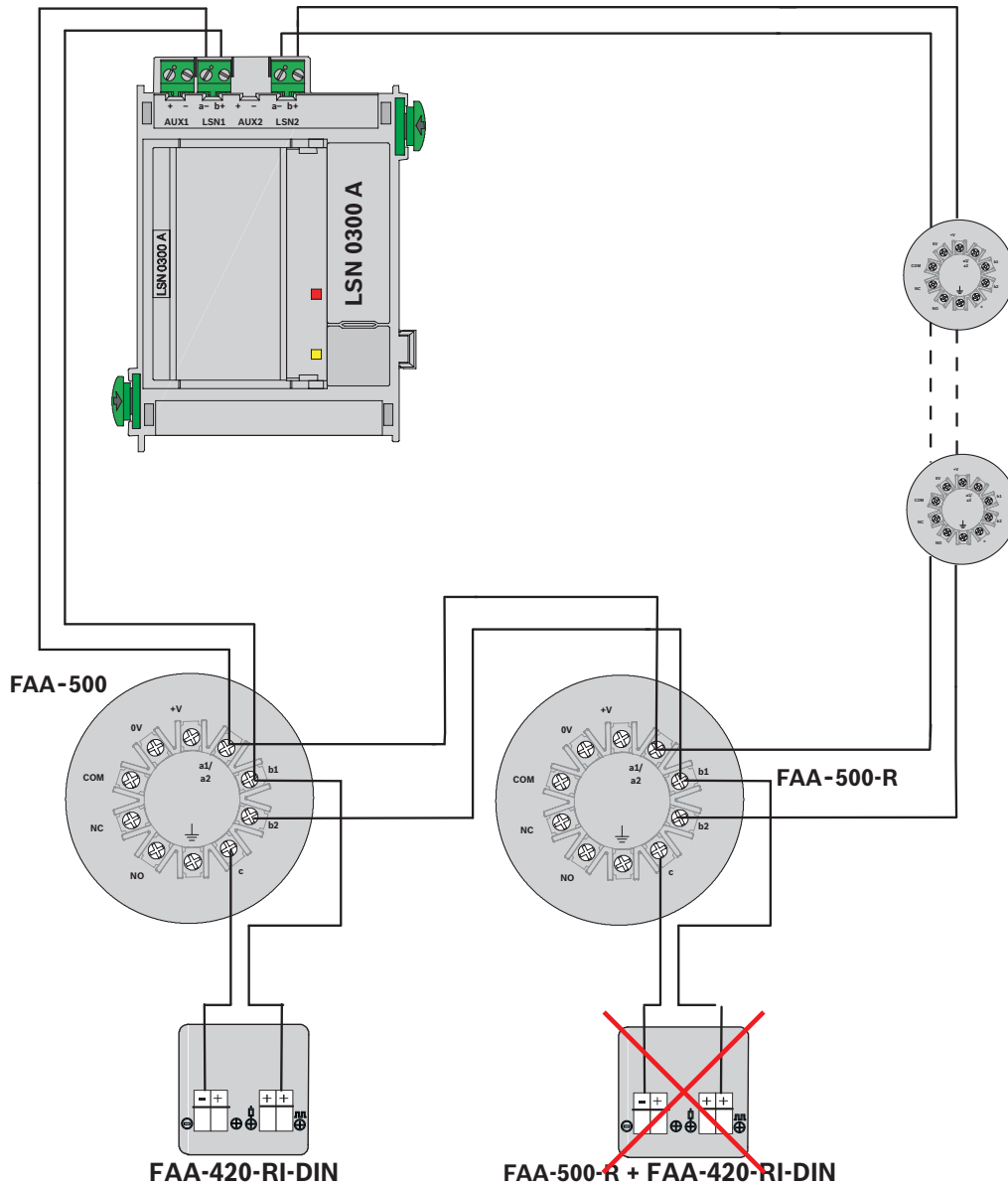
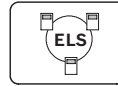



**FAA-MSR-420**  
**FAP-425-O, FAP-425-O-R**  
**FAP-425-OT, FAP-425-OT-R**  
**FAP-425-T-R**  
**FAP-425-DO-R, FAP-425-DOT-R**  
**FAP-425-DOTC-R, FAP-425-DOTCO-R**

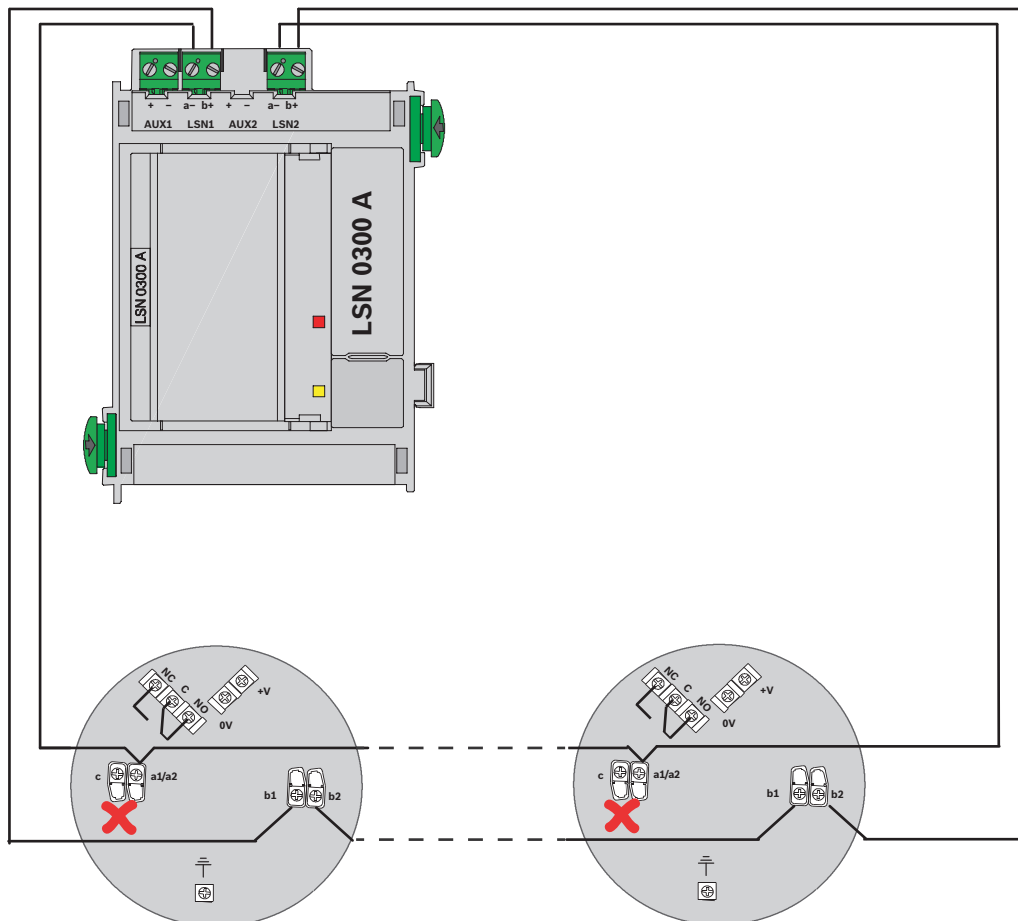
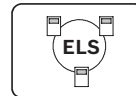



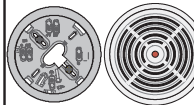

MS 400, MS 400 B  
 FAP-425-O, FAP-425-O-R  
 FAP-425-OT, FAP-425-OT-R  
 FAP-425-T-R  
 FAP-425-DO-R, FAP-425-DOT-R  
 FAP-425-DOTC-R, FAP-425-DOTCO-R

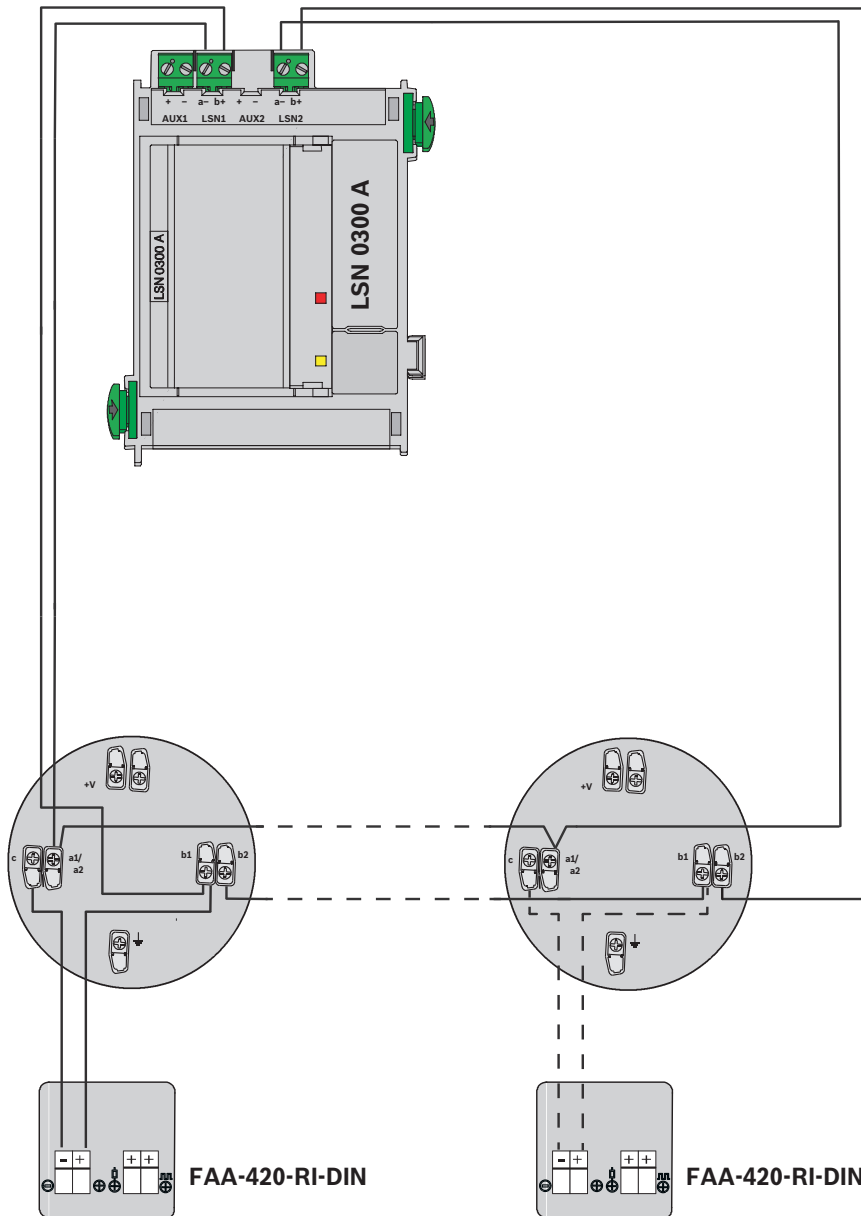
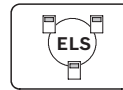

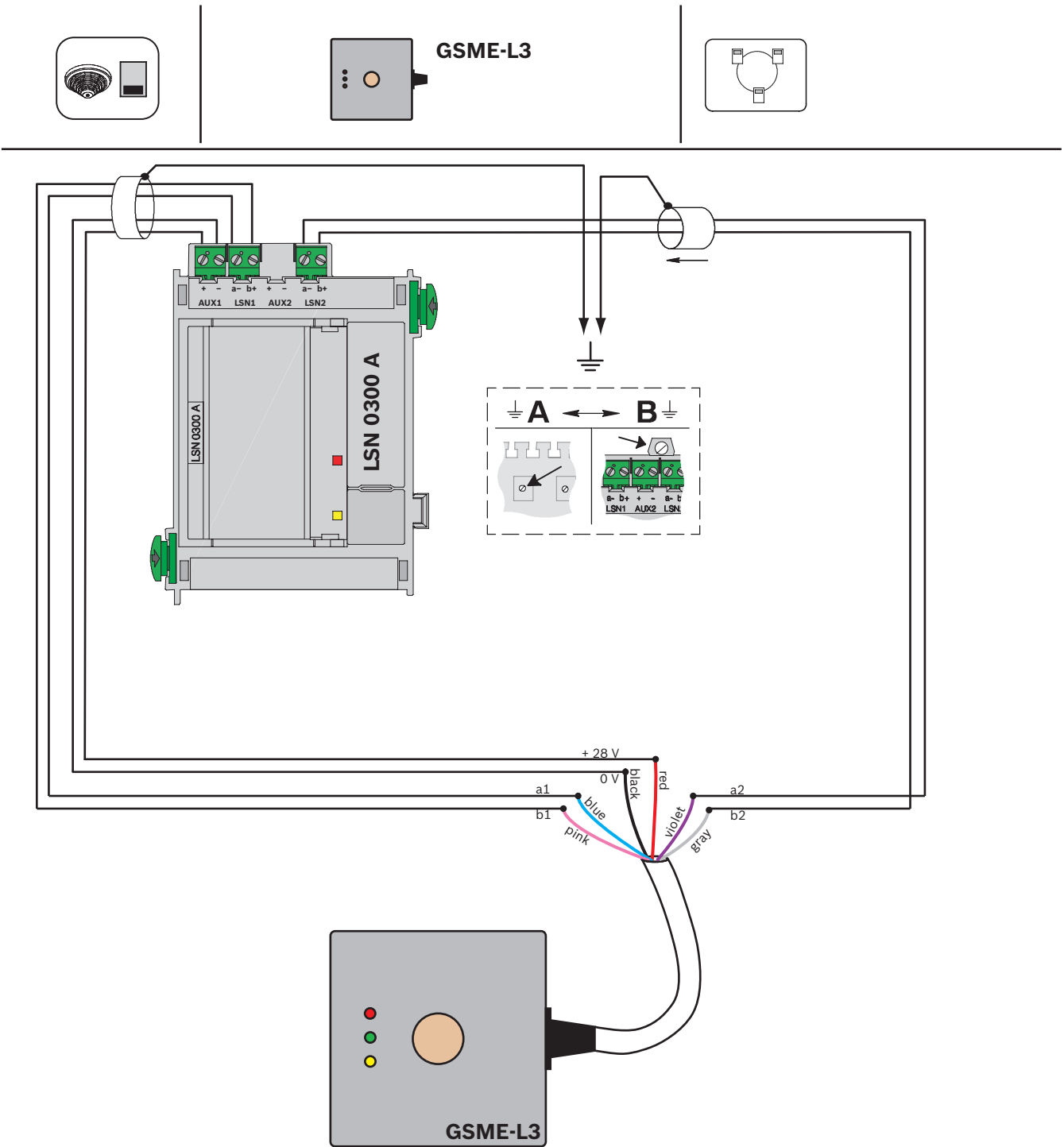

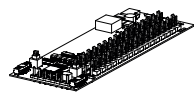

ATB 420 LSNi

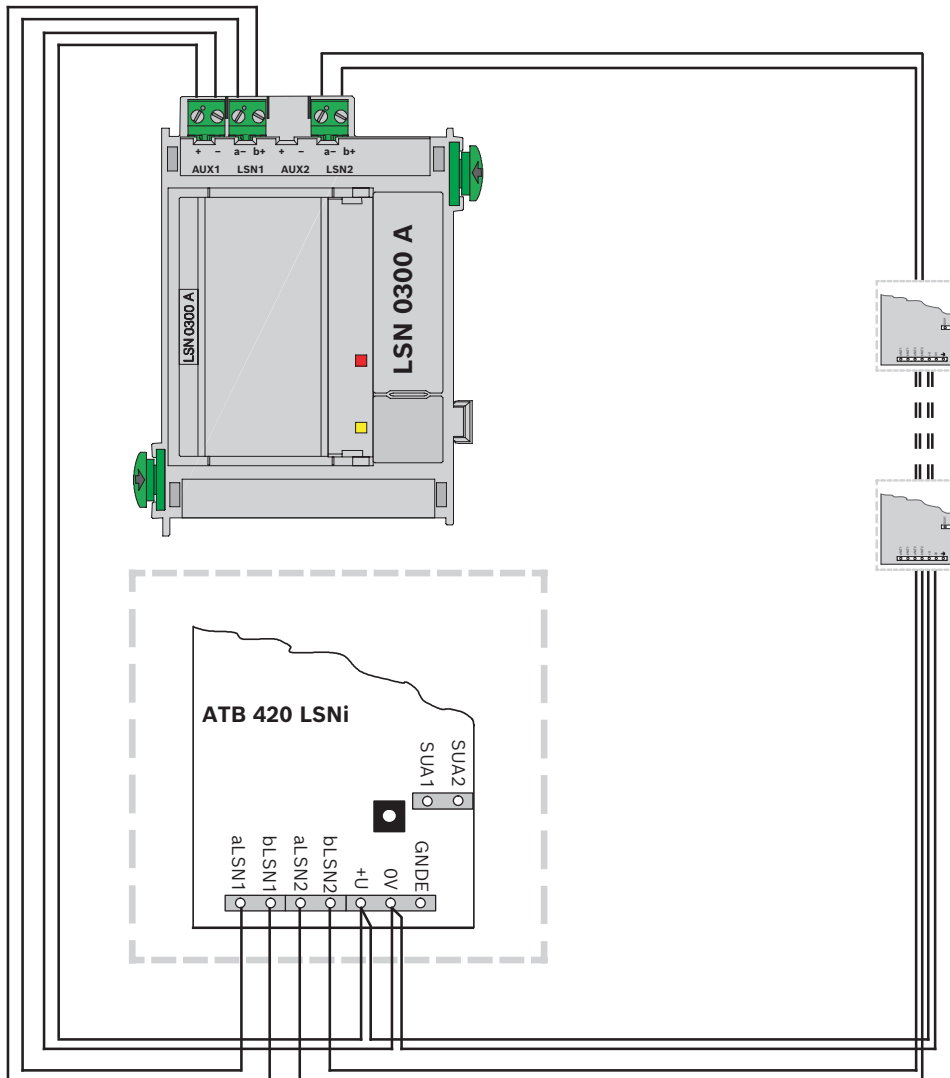
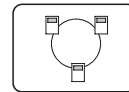



**BAT 100 LSN**  
**ATG 420 LSNi**

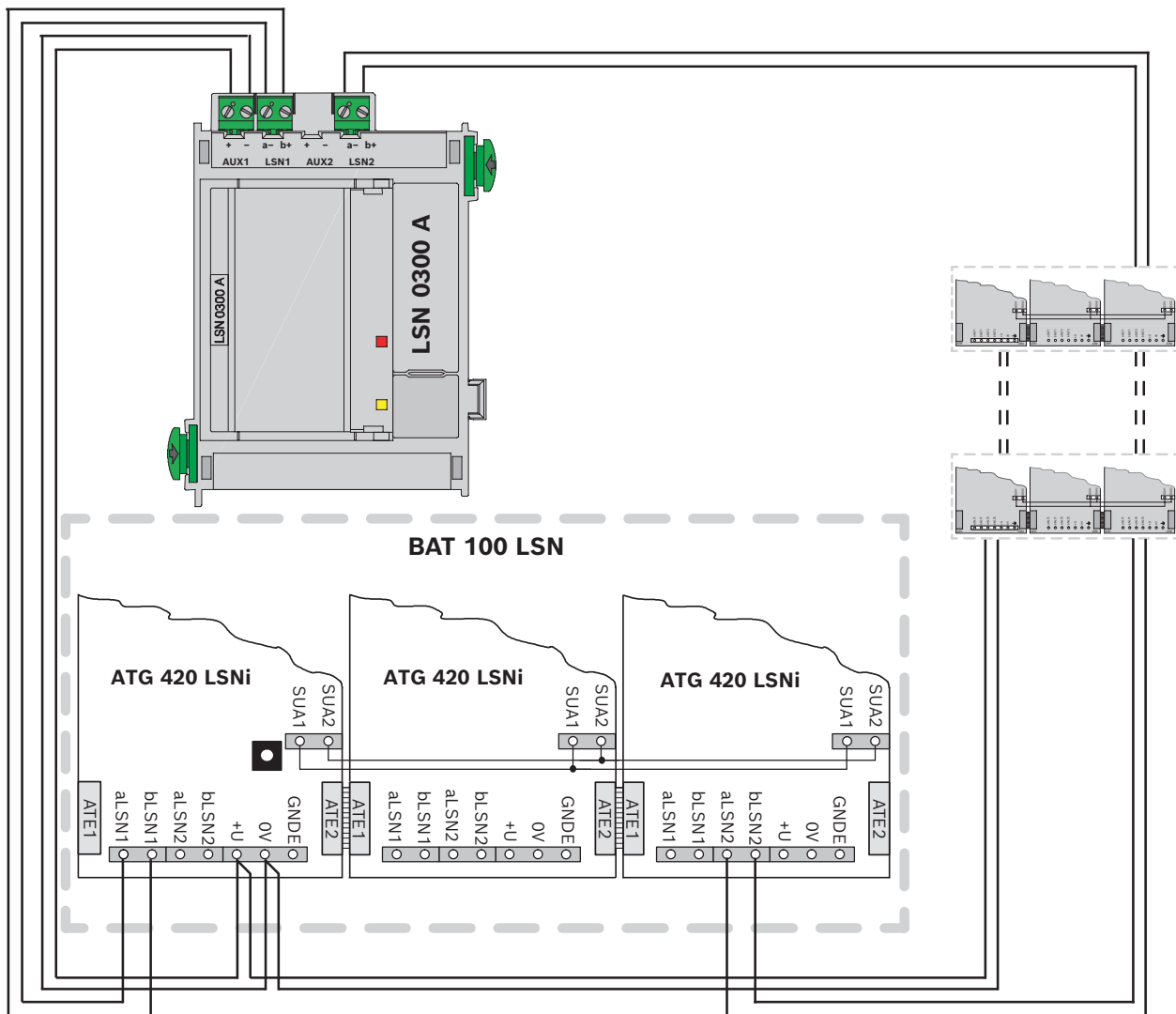
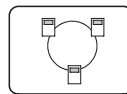

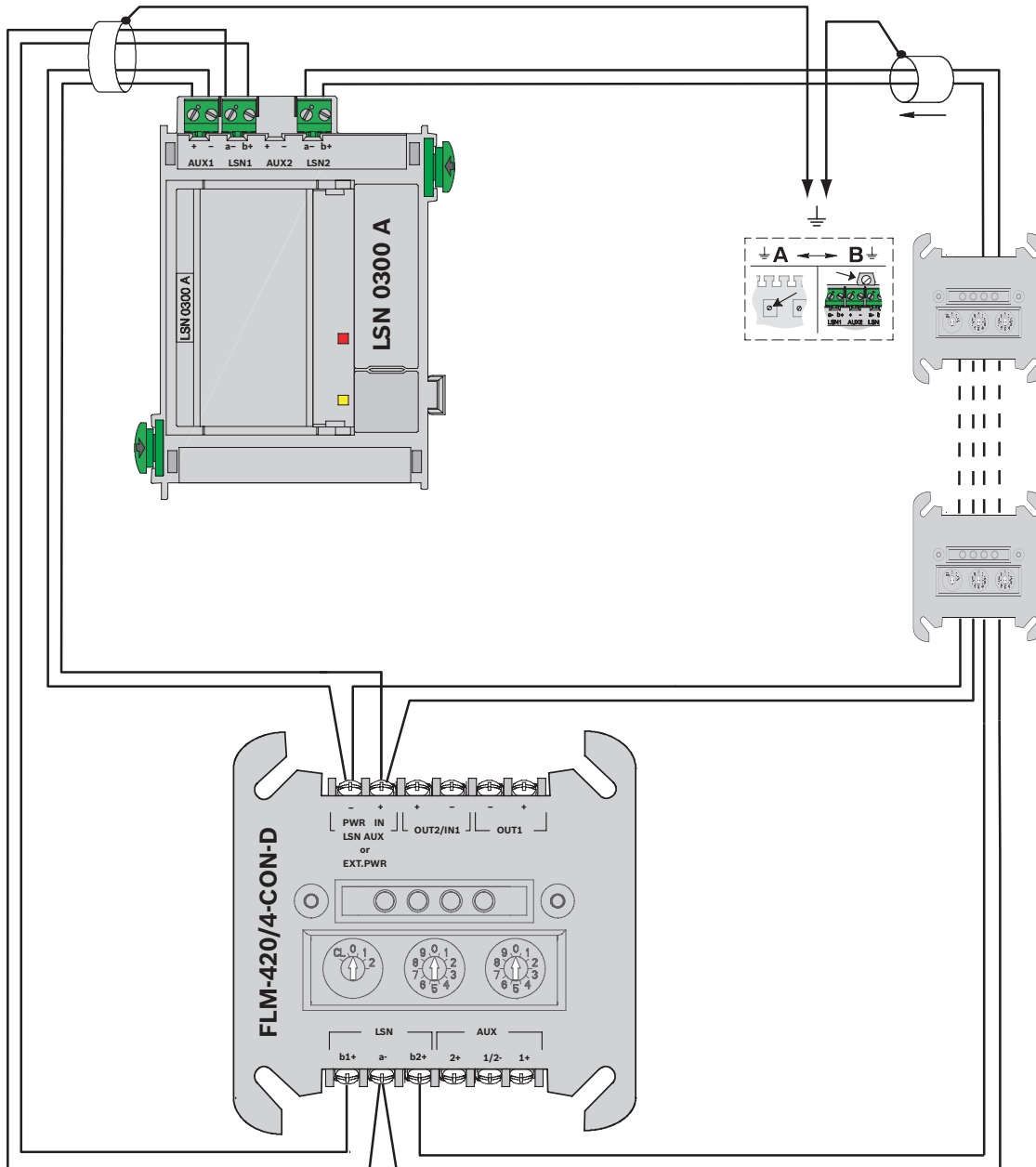
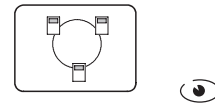
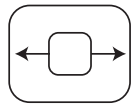



FBF 100 LSN

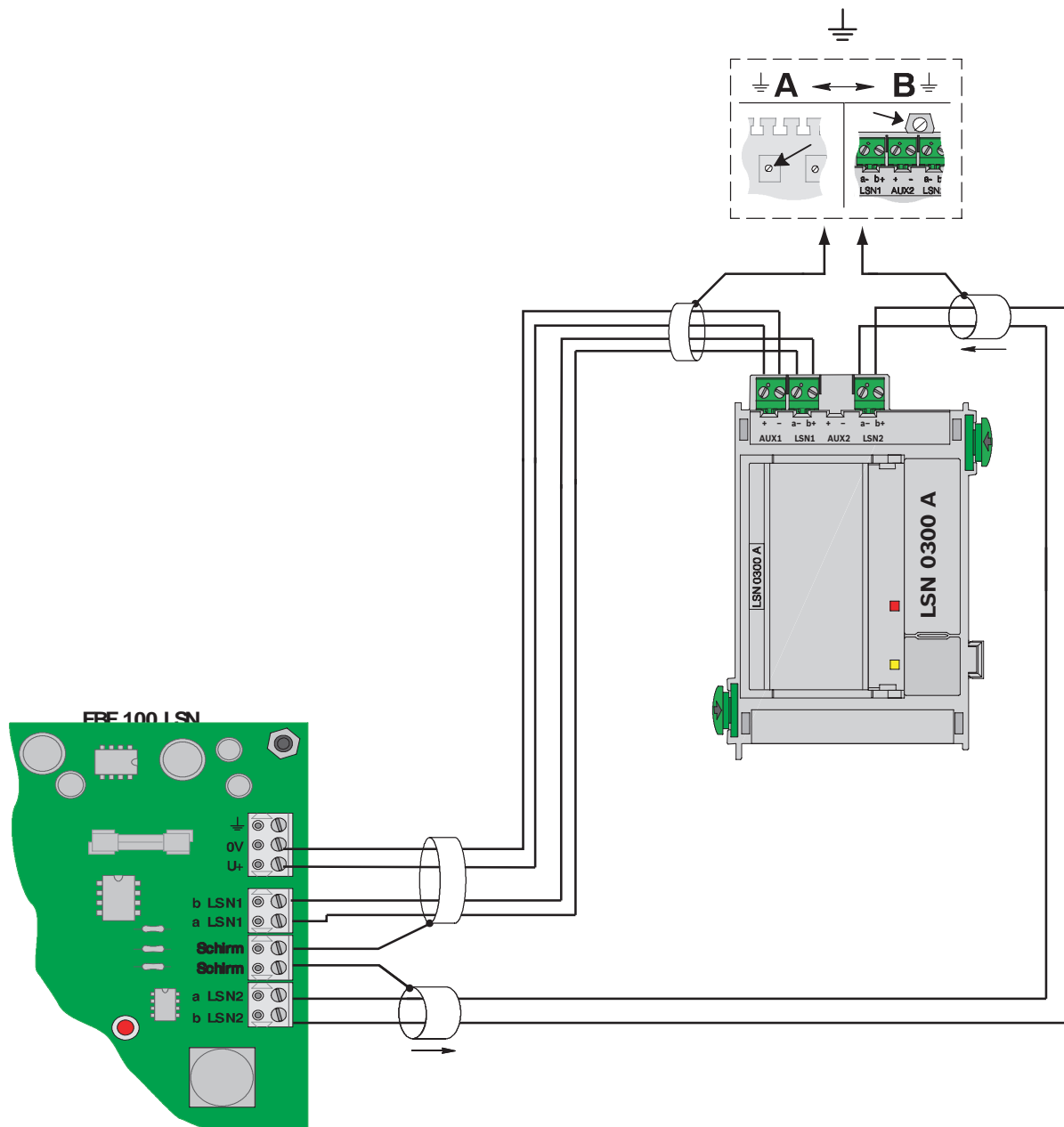
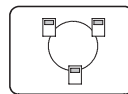

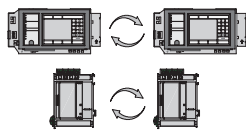

FLM-420-RLE-S

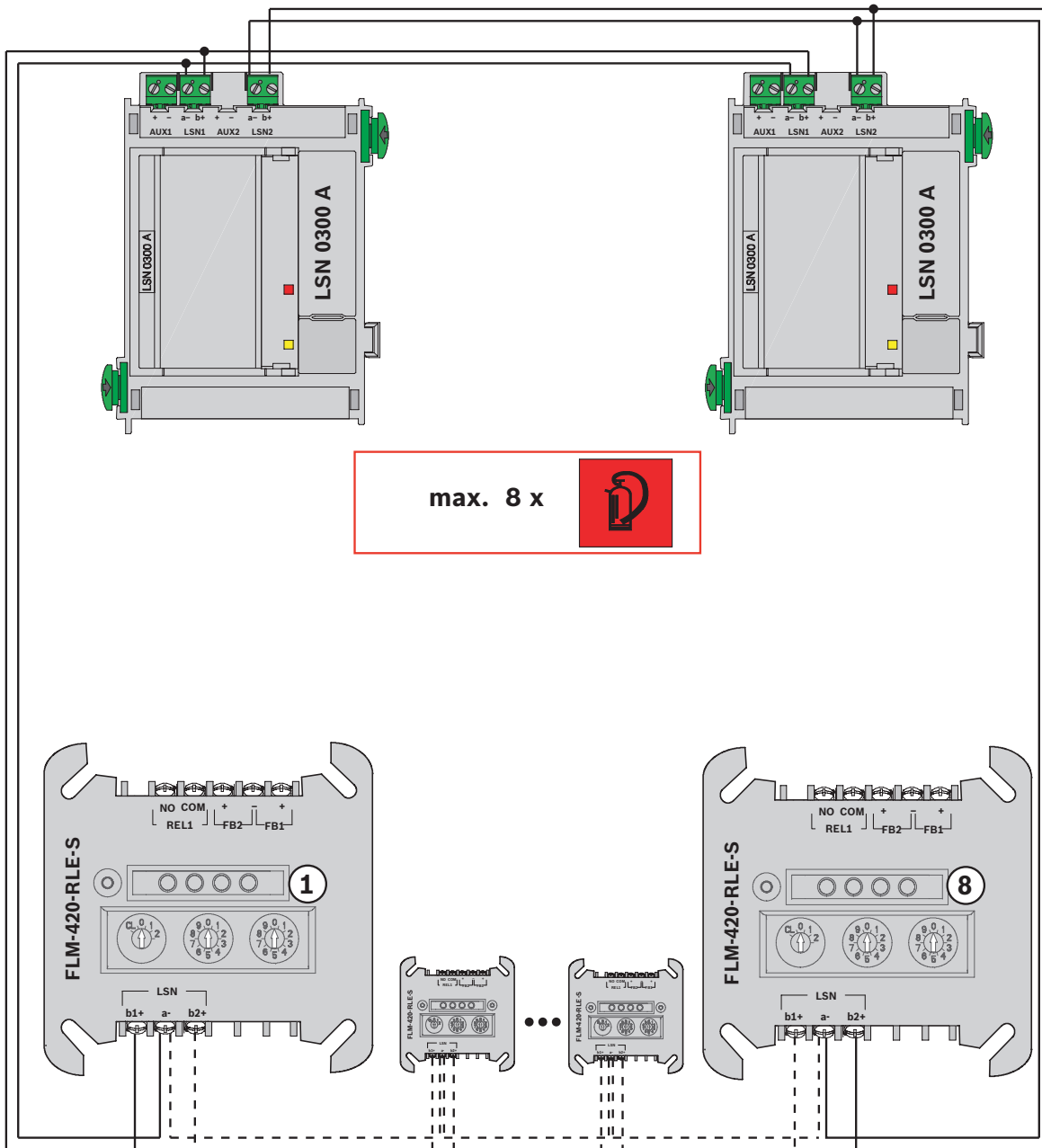
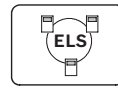



**FNX-425U-WFWH**  
**FNX-425U-RFWH**  
**FNX-425U-WFRD**  
**FNX-425U-RFRD**

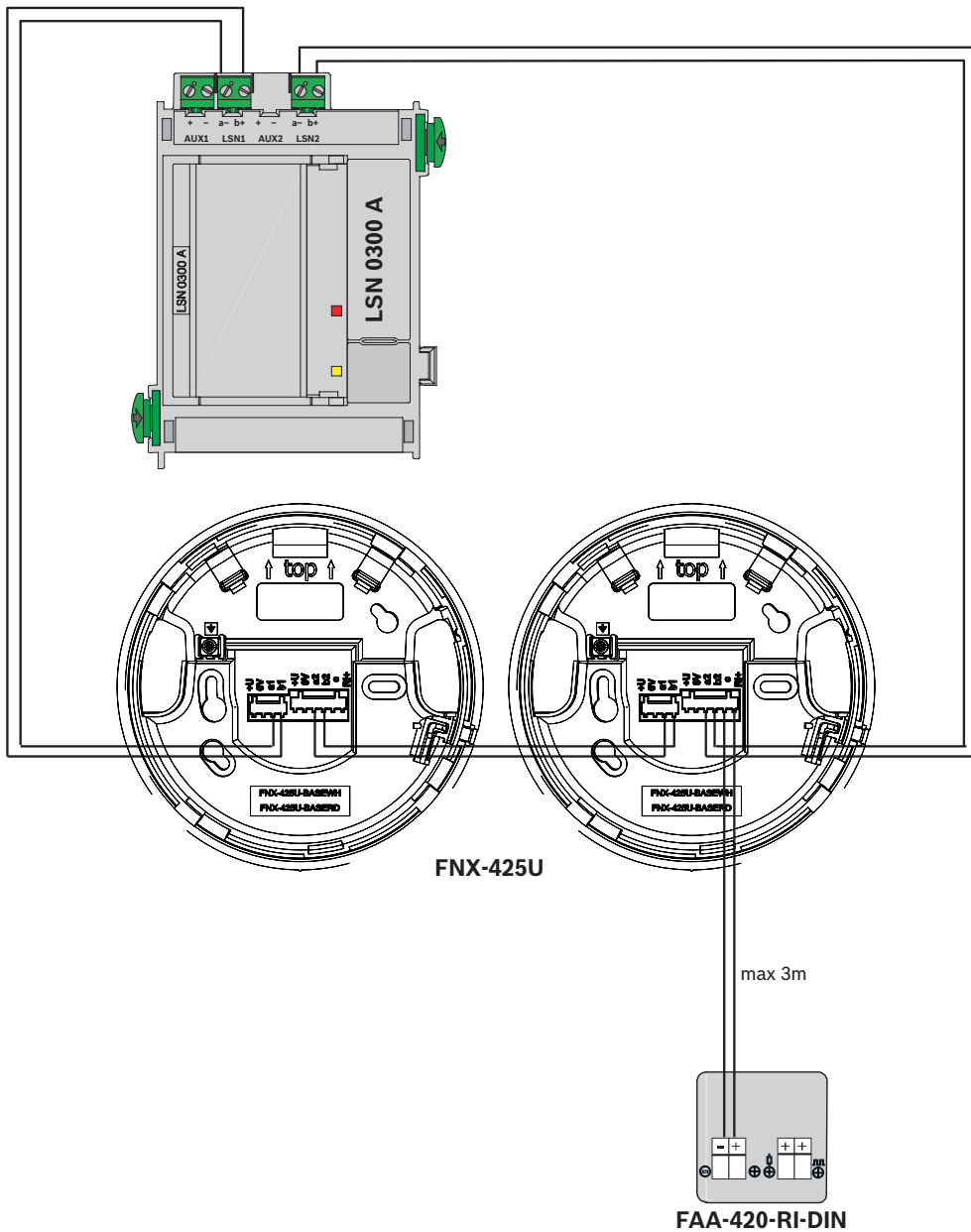
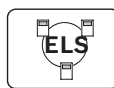





FNX-425U-WFWH  
 FNX-425U-RFWH  
 FNX-425U-WFRD  
 FNX-425U-RFRD

+ FNX-425U-COVWH  
 FNX-425U-COVRD

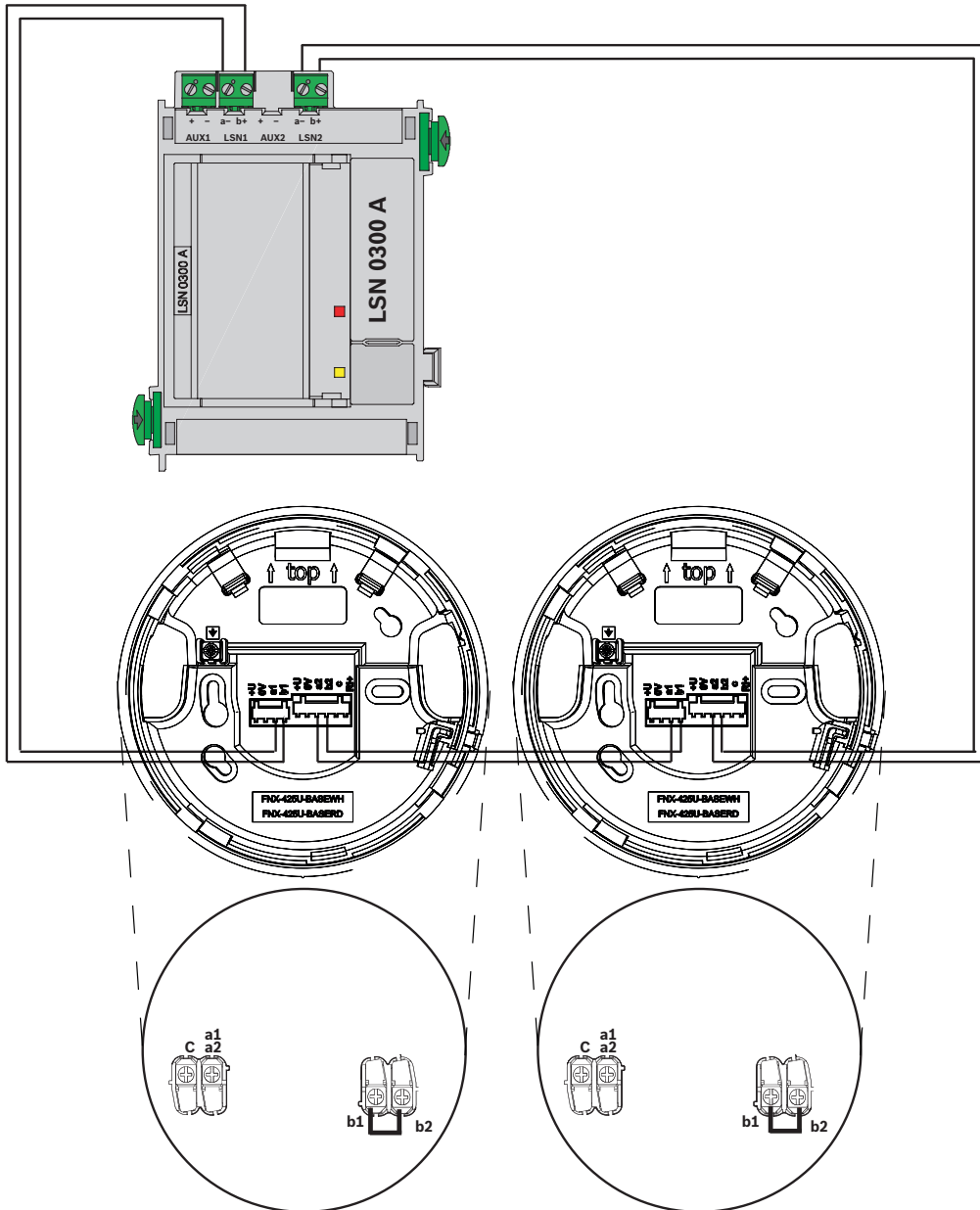
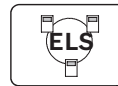

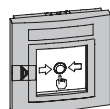
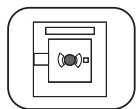

FMC-210...

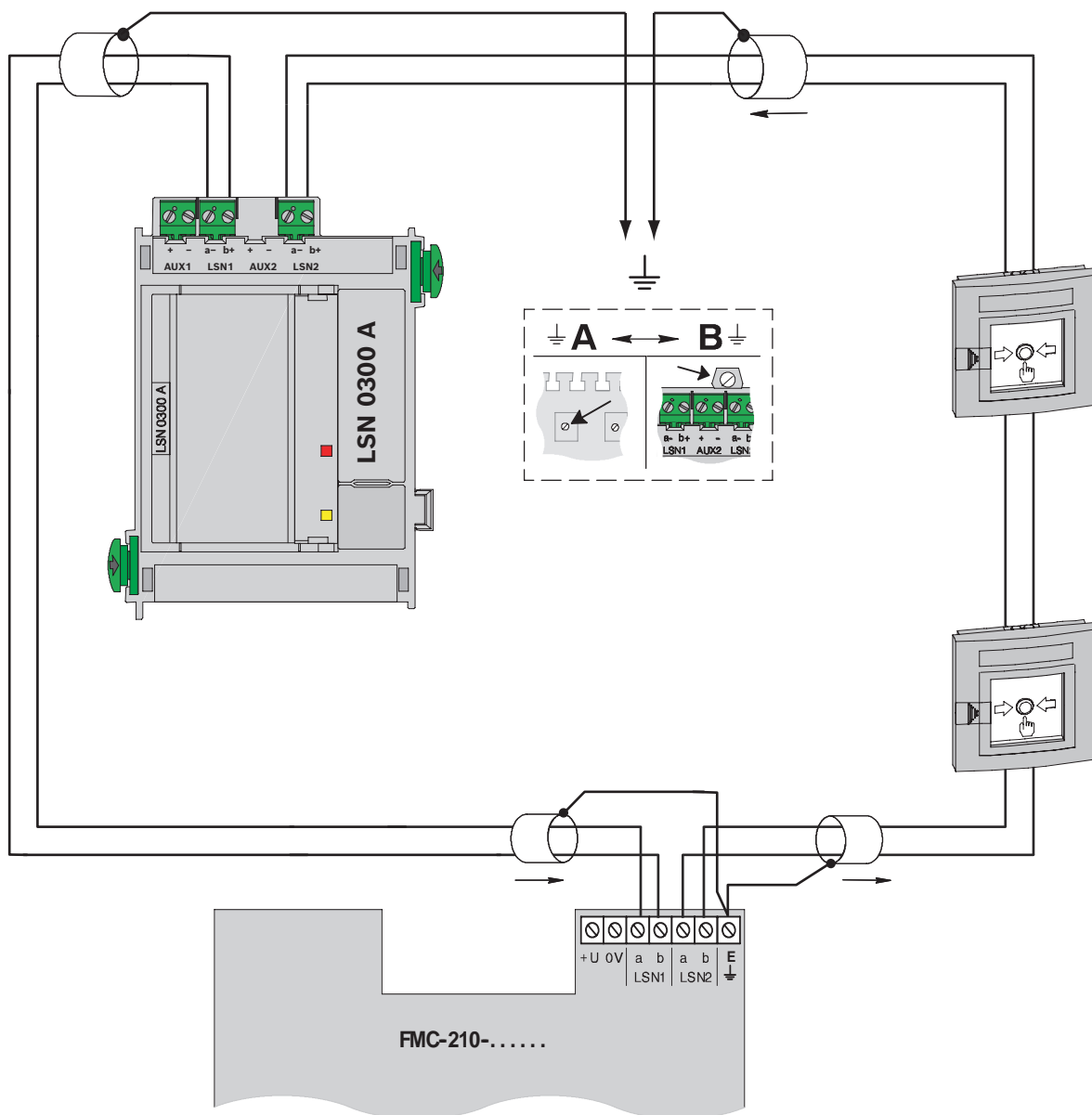
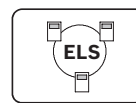

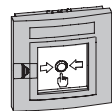
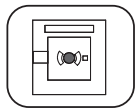

**FMC-210-IP66-R**

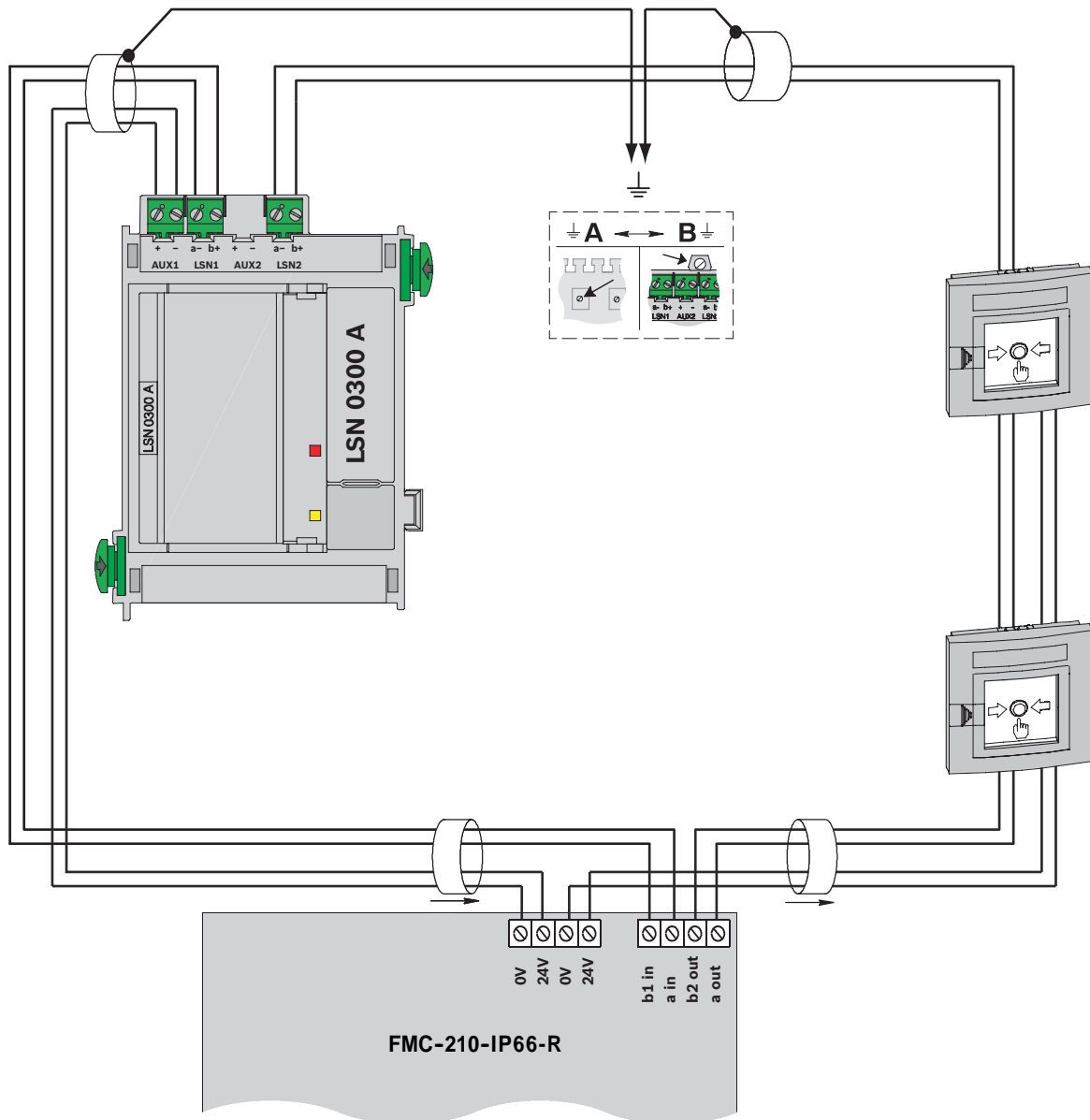
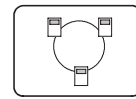

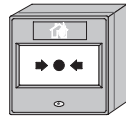
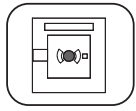

FMC-420RW-HSGRD  
 FMC-420RW-HSRRD  
 FMC-420RW-GFGRD  
 FMC-420RW-GFRRD  
 FMC-420RW-GSGRD  
 FMC-420RW-GSRRD

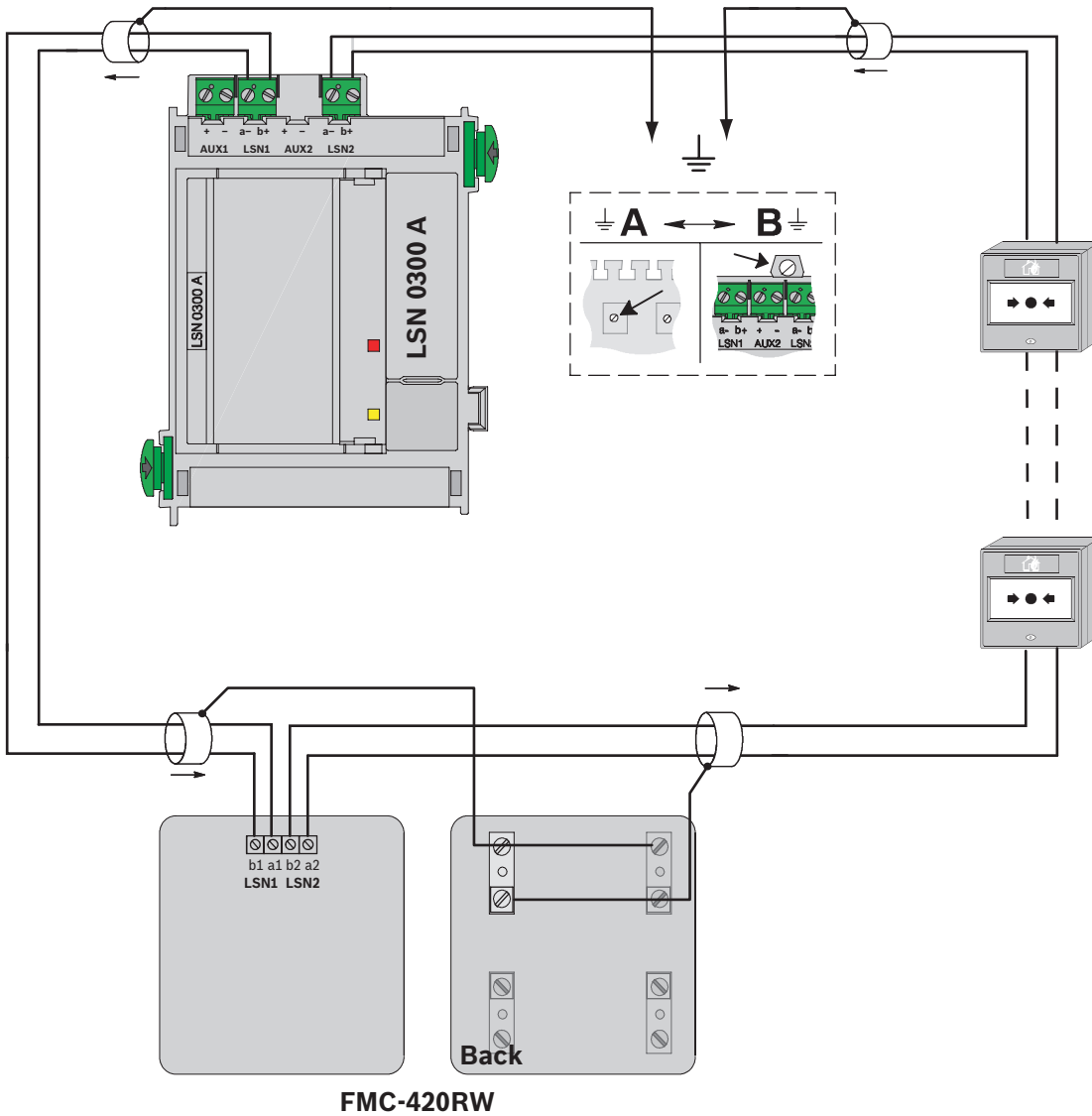
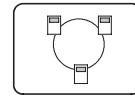

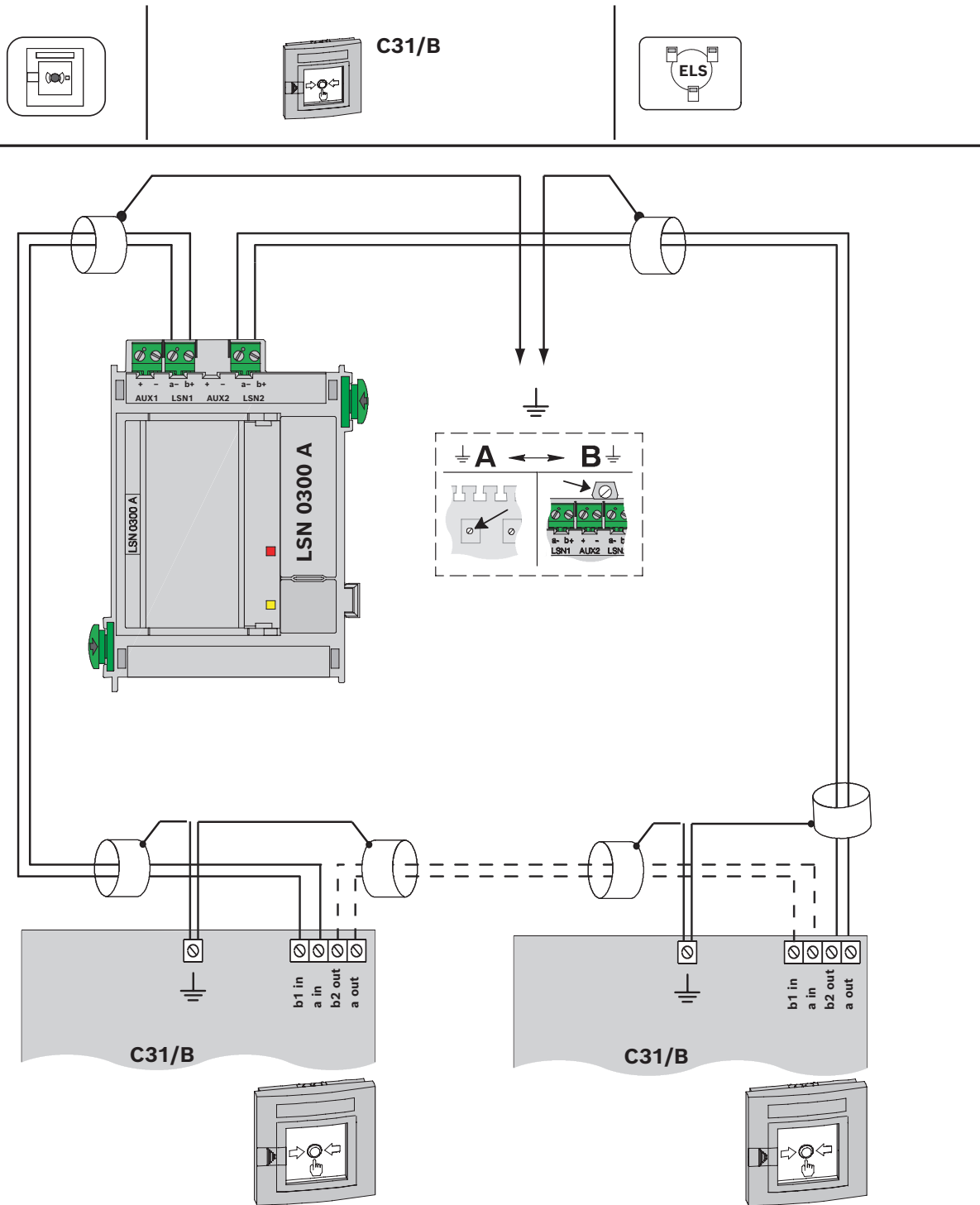

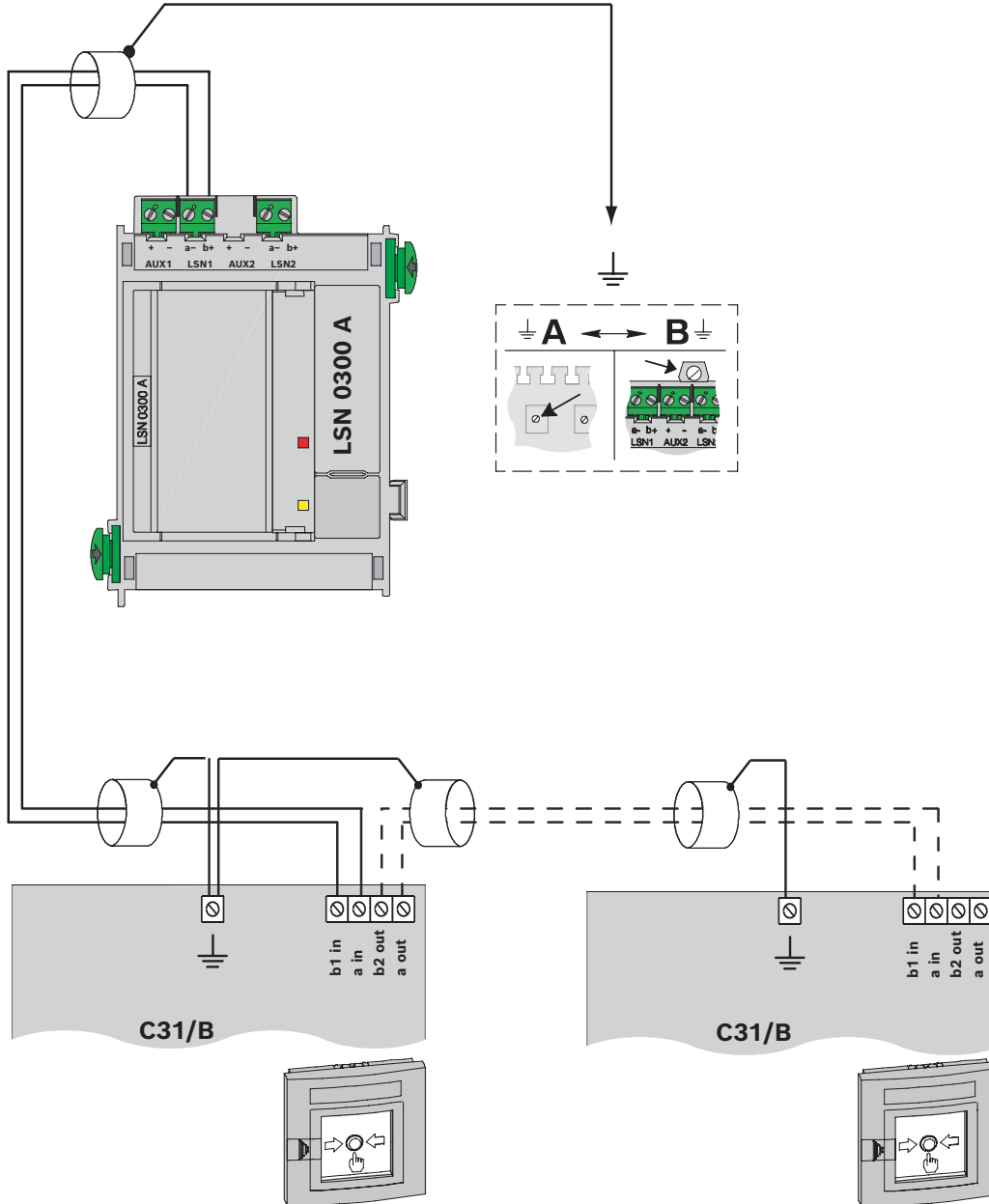
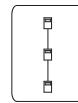
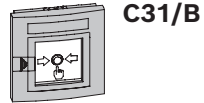
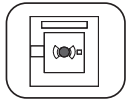

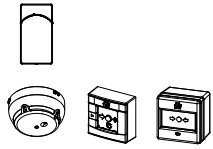

**FWI-270**

**FDOOT271-O**

**FDM275-O**

**FDM273-O**

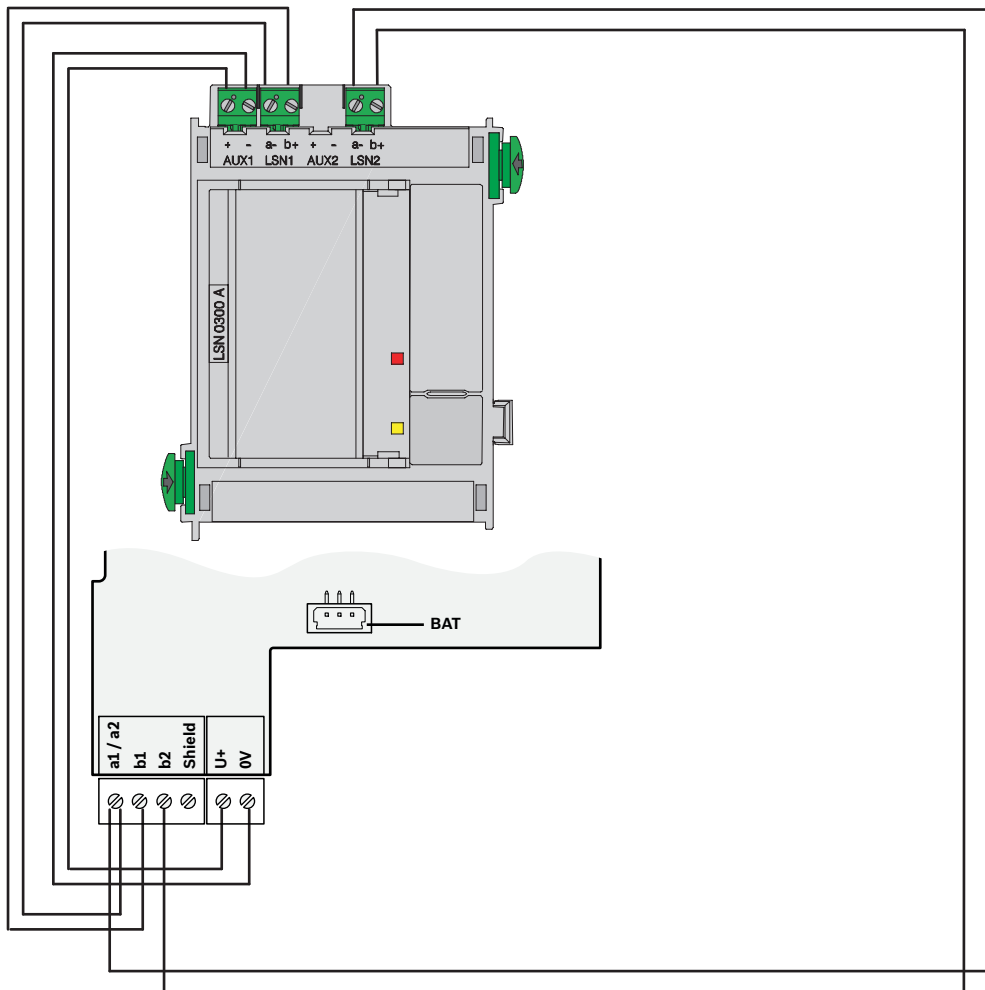
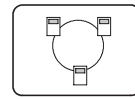

2.4.5

NZM 0002 A

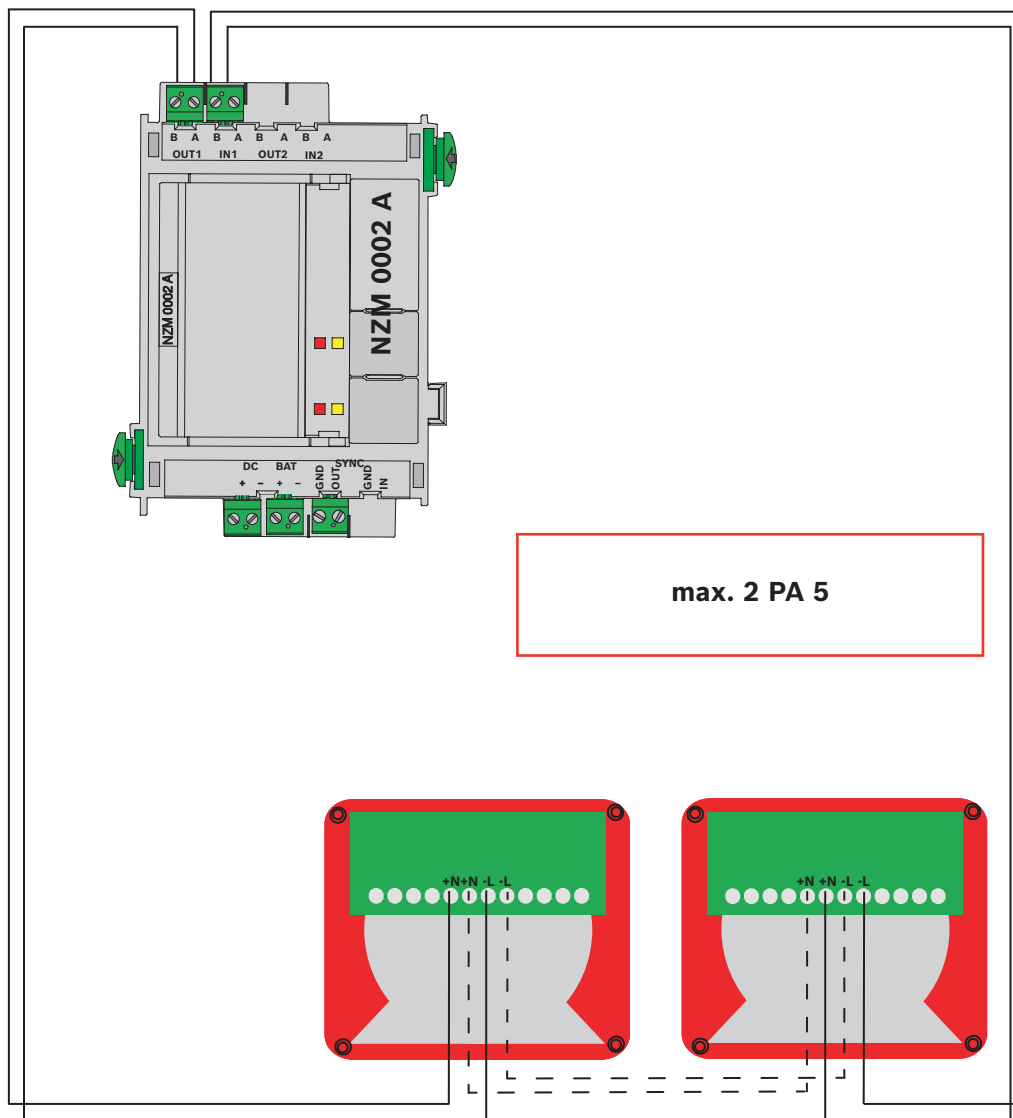
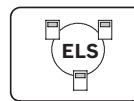



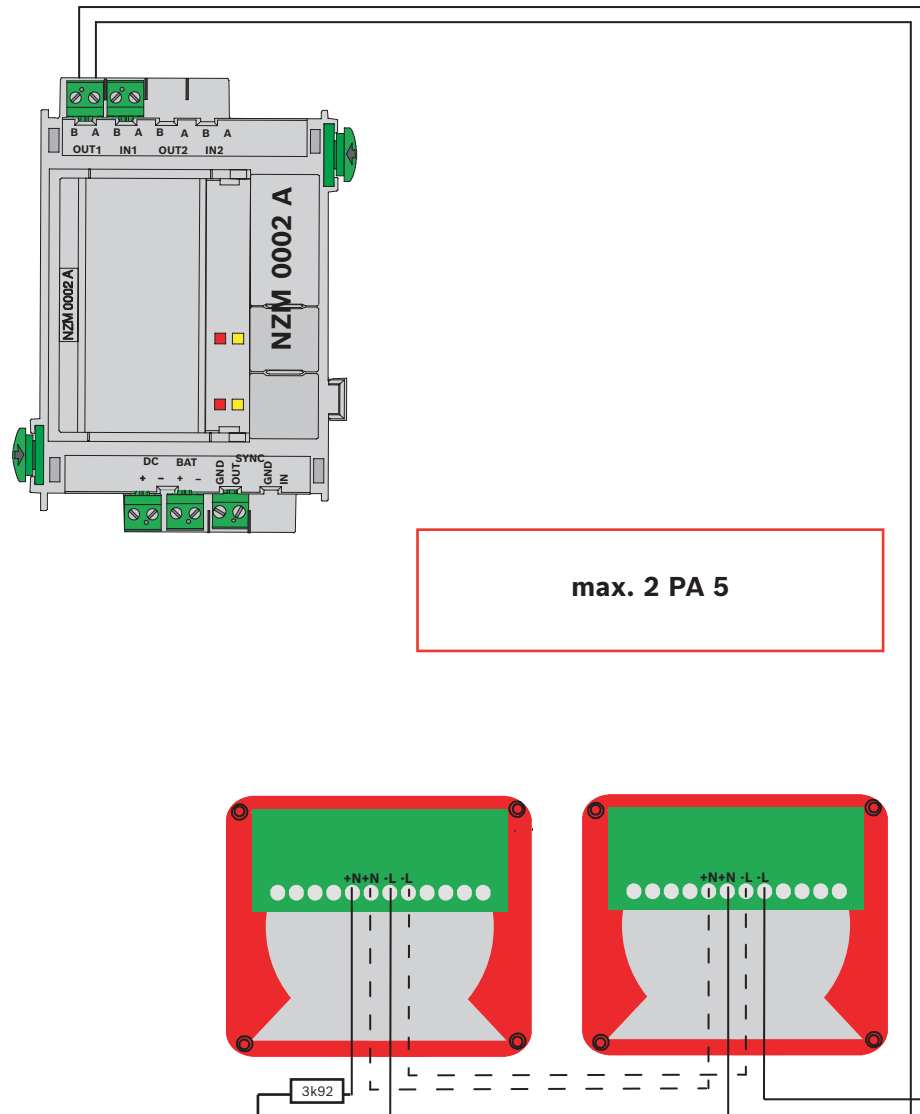
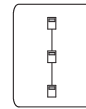

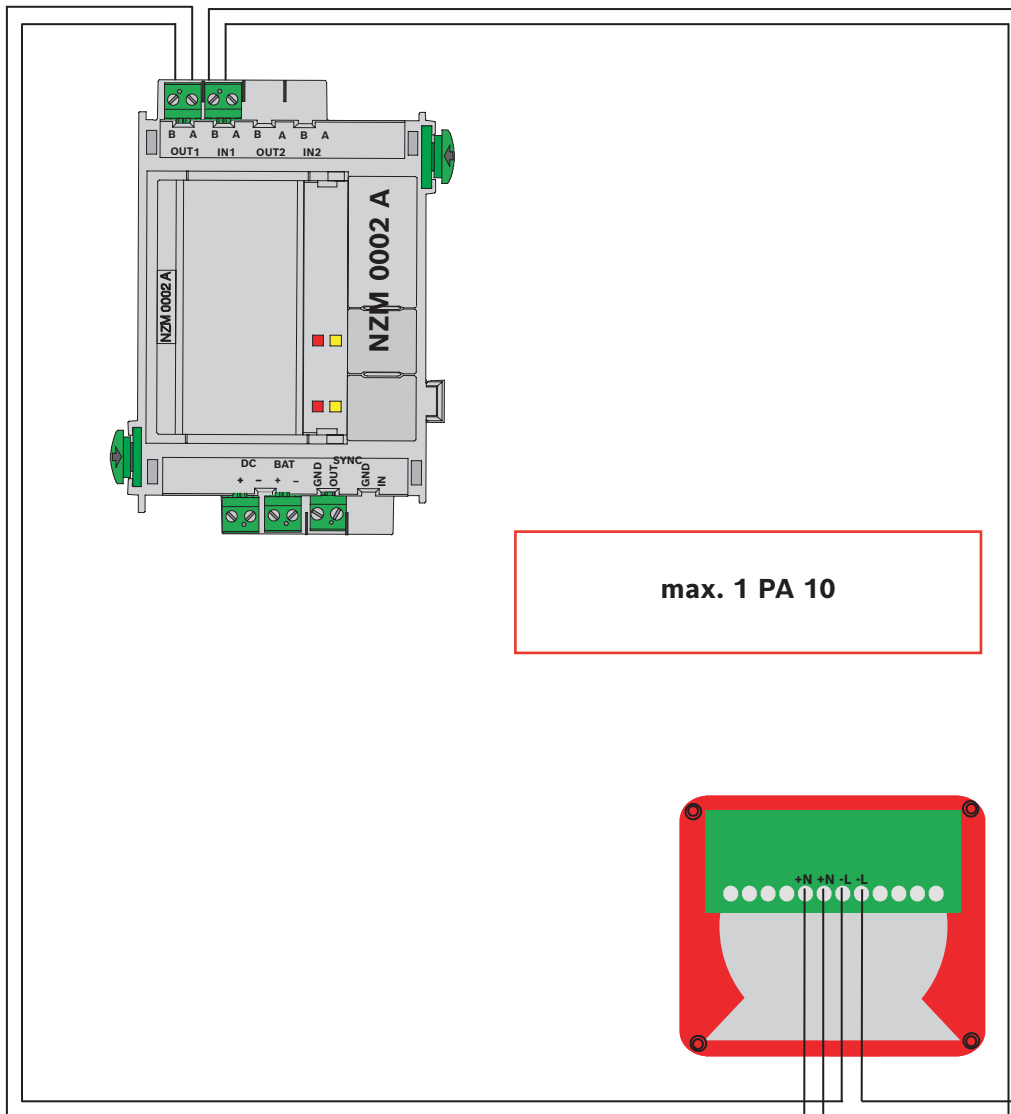
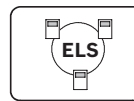

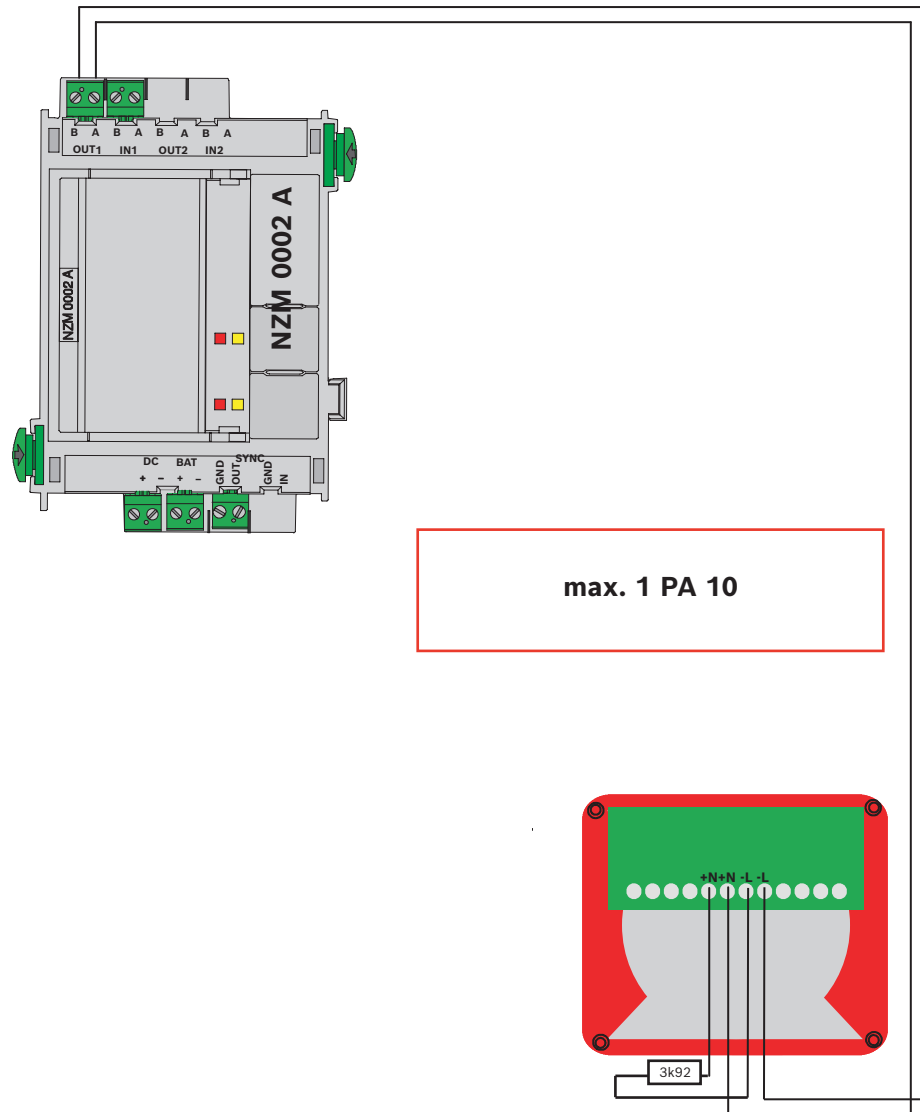
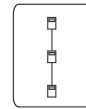

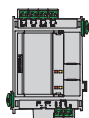
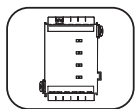

NZM 0002 A

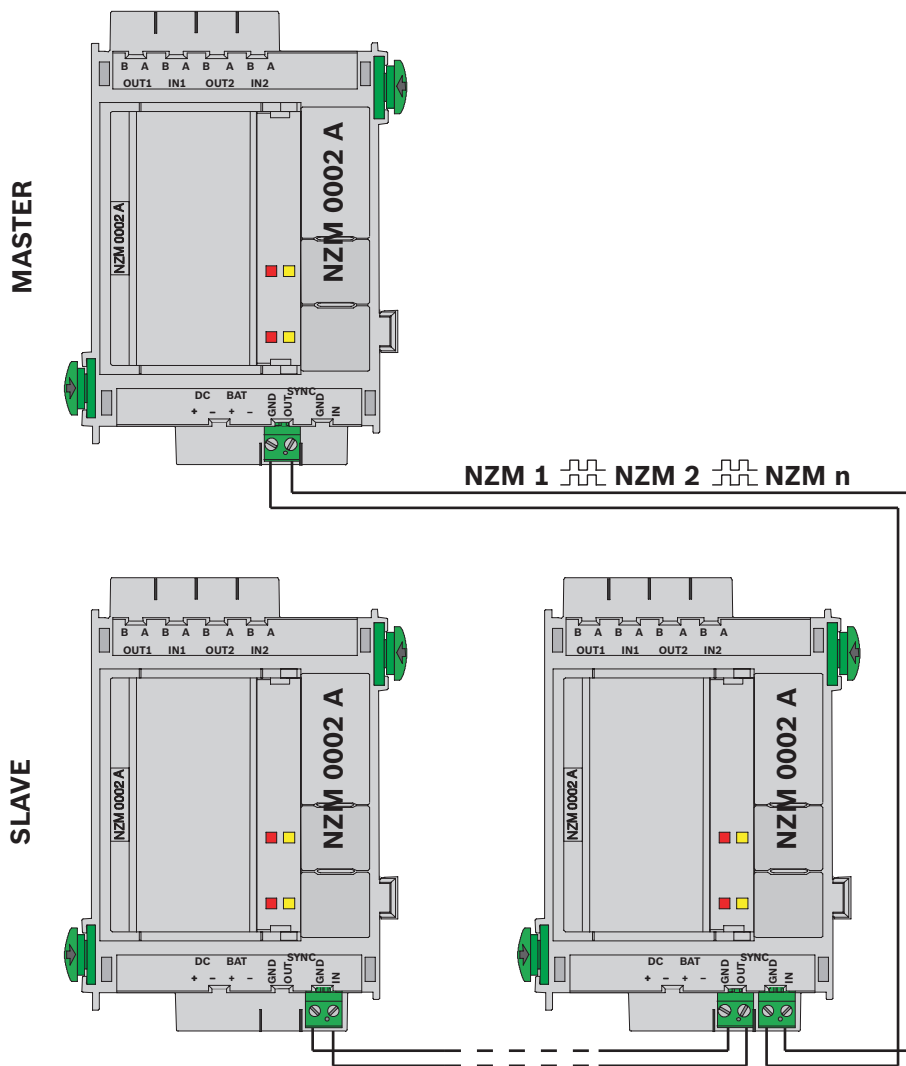

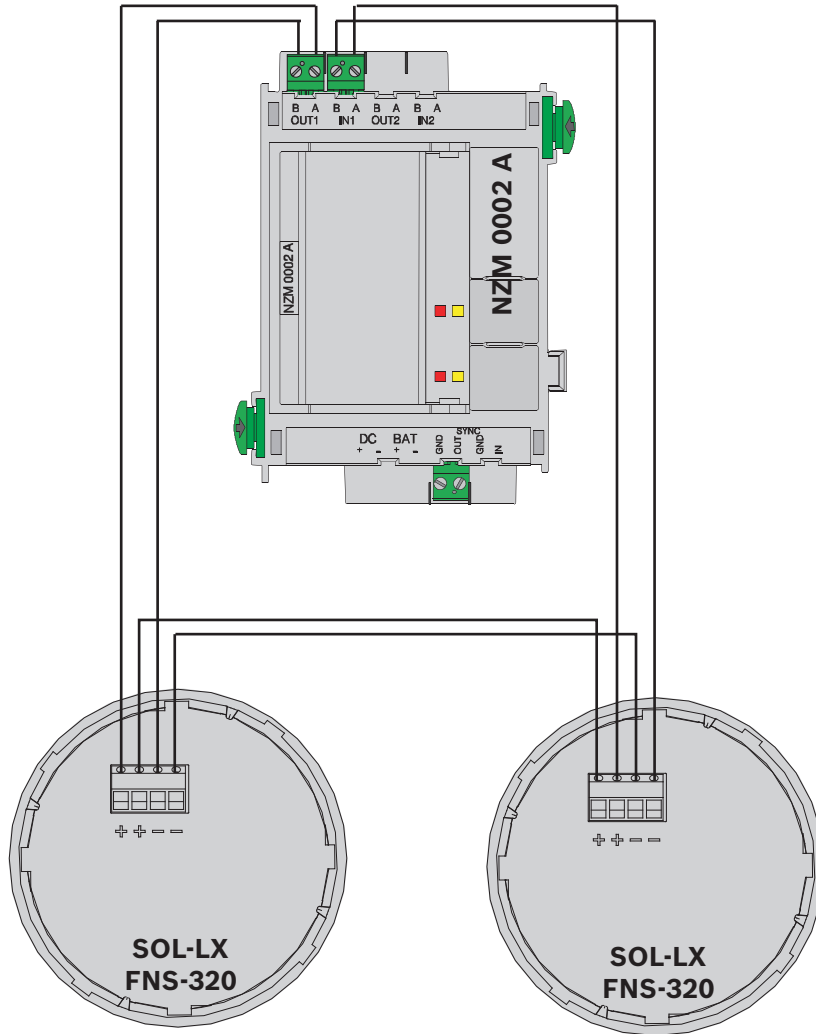
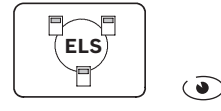

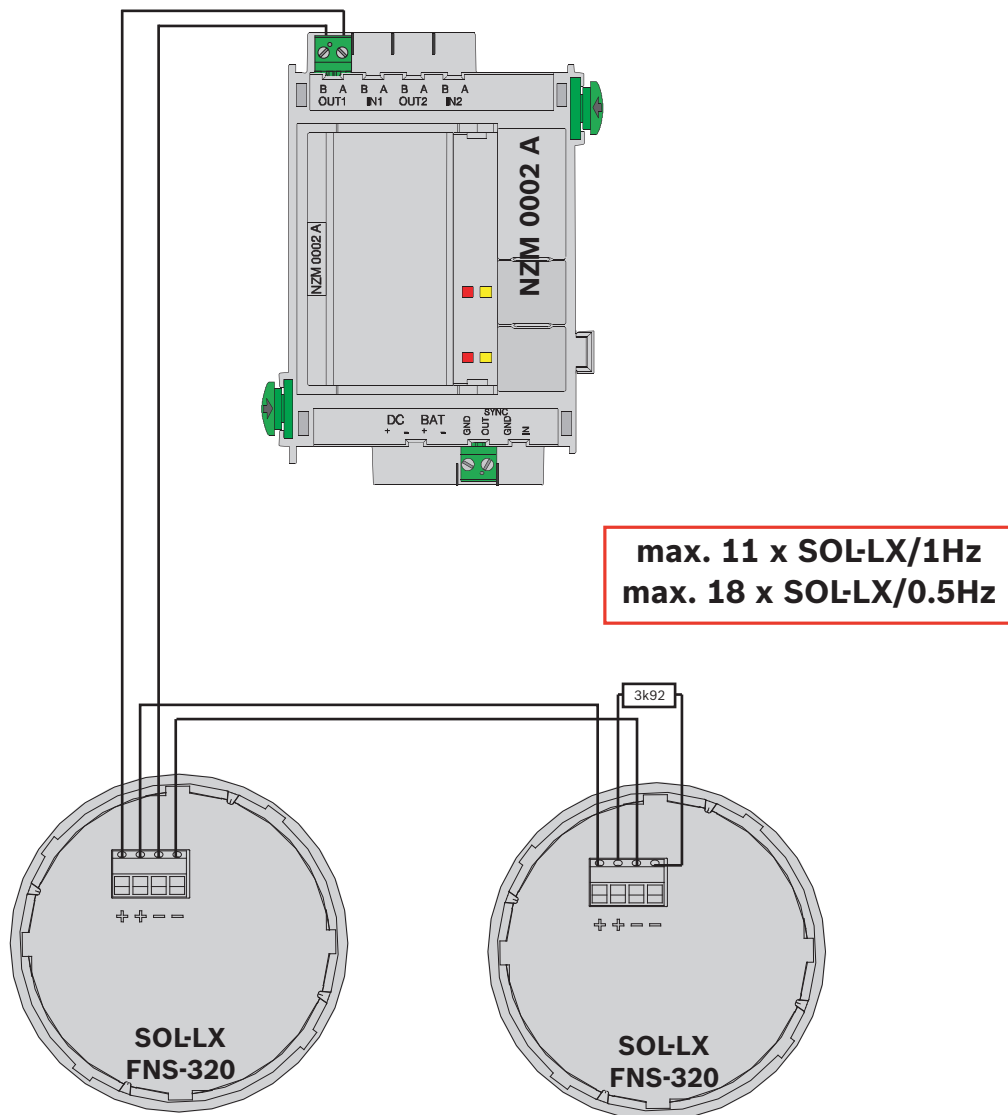
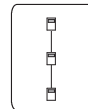

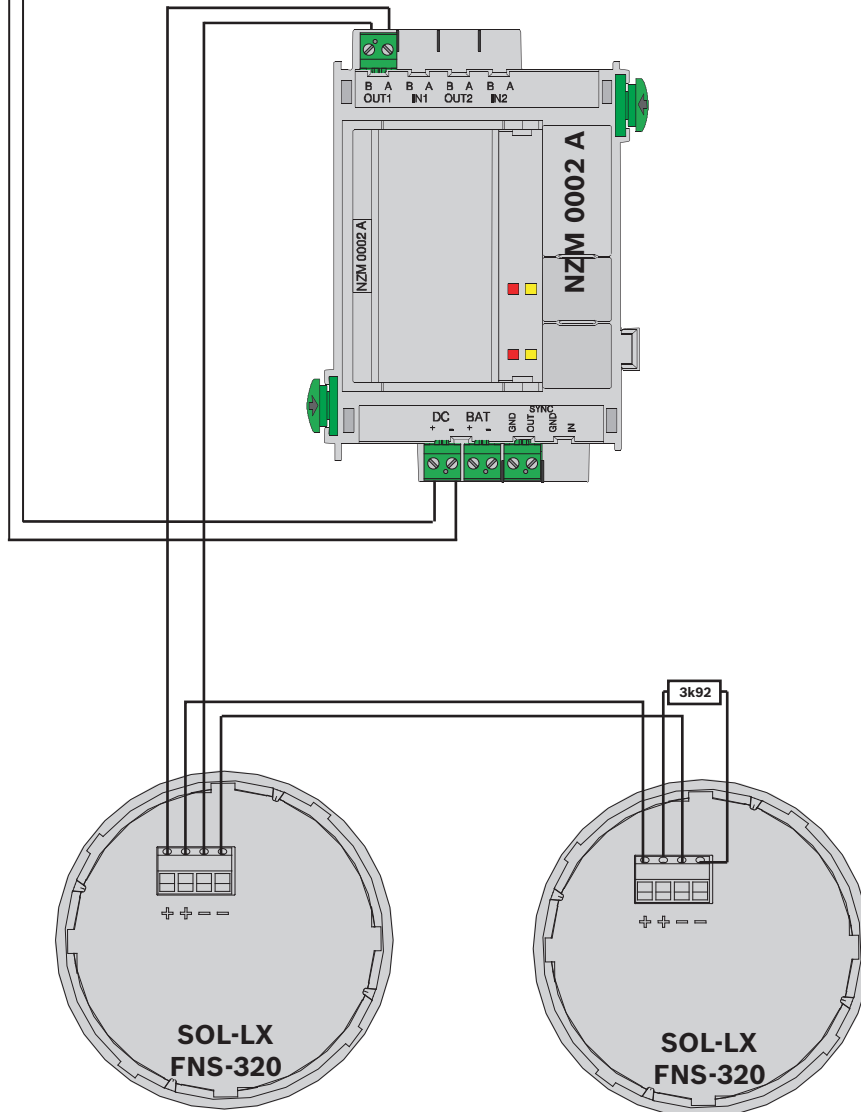
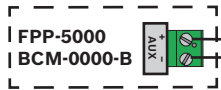
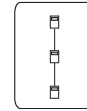

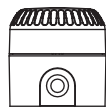

**ROLP-W-LX  
FNM-320**

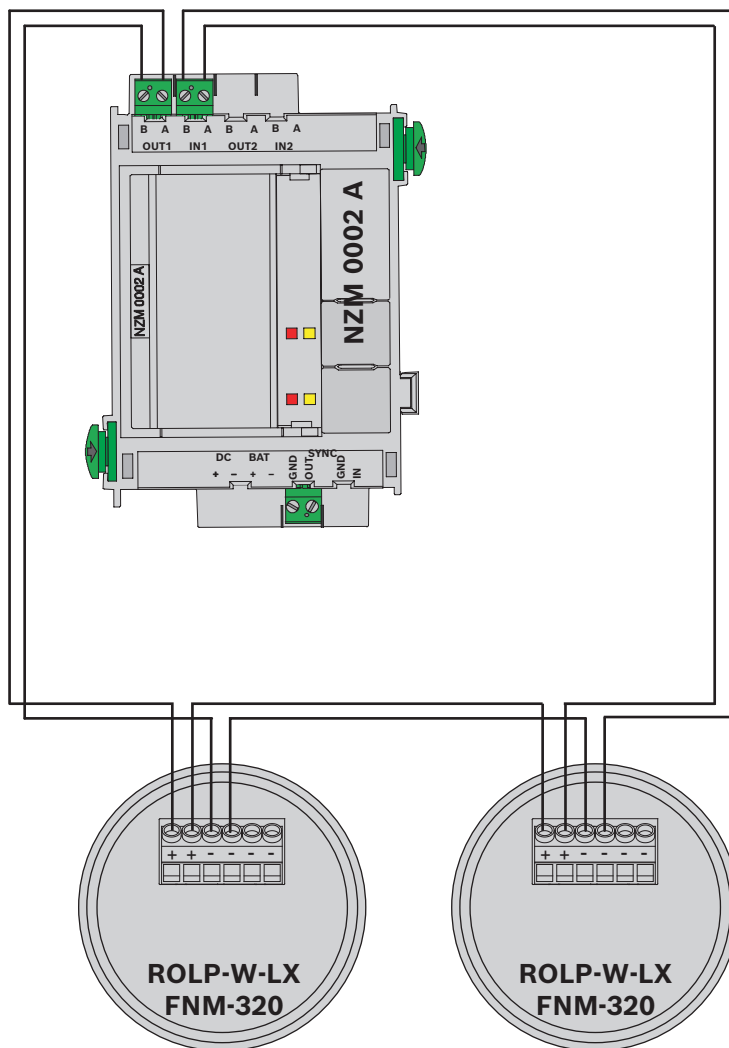
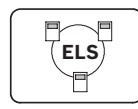



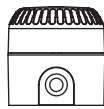

**ROLP-W-LX  
FNM-320**

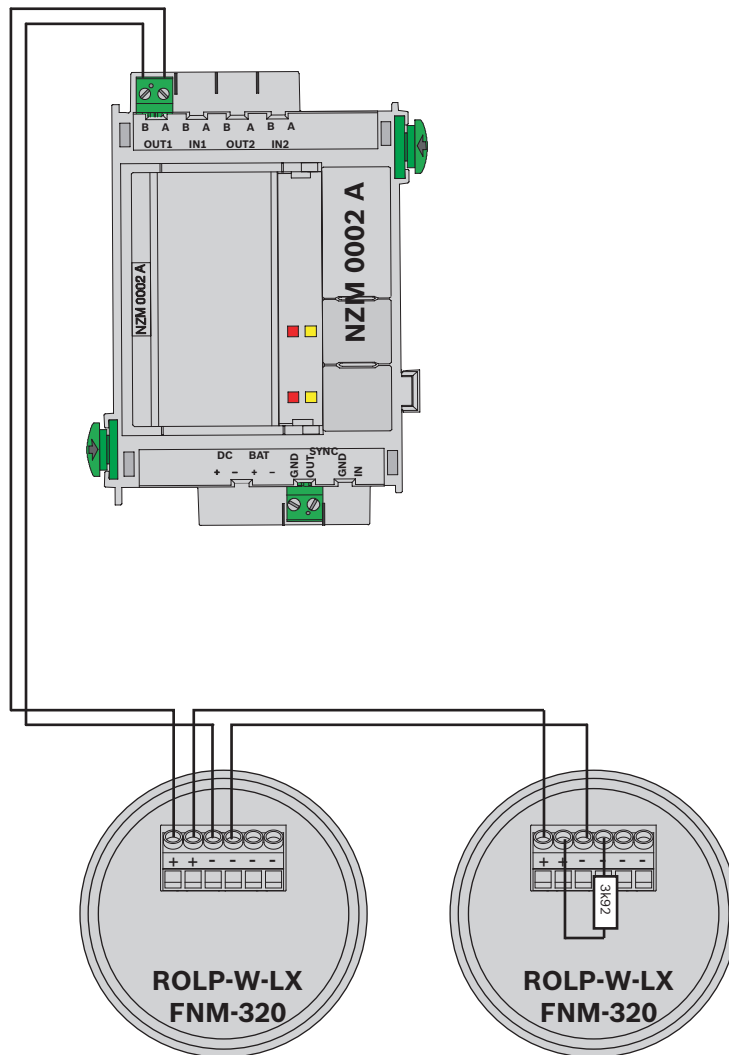
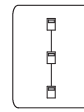



PB 2005

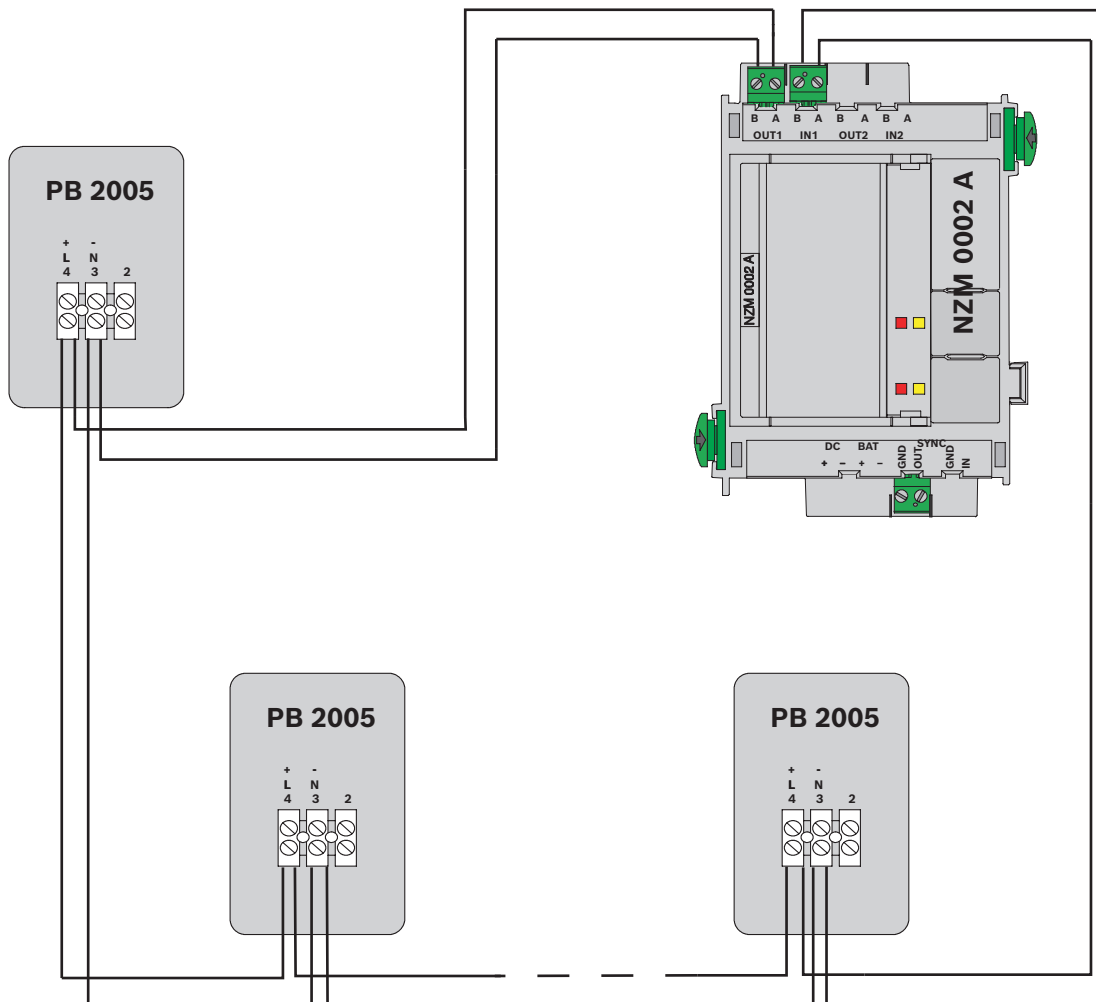
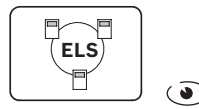



**PB 2005**

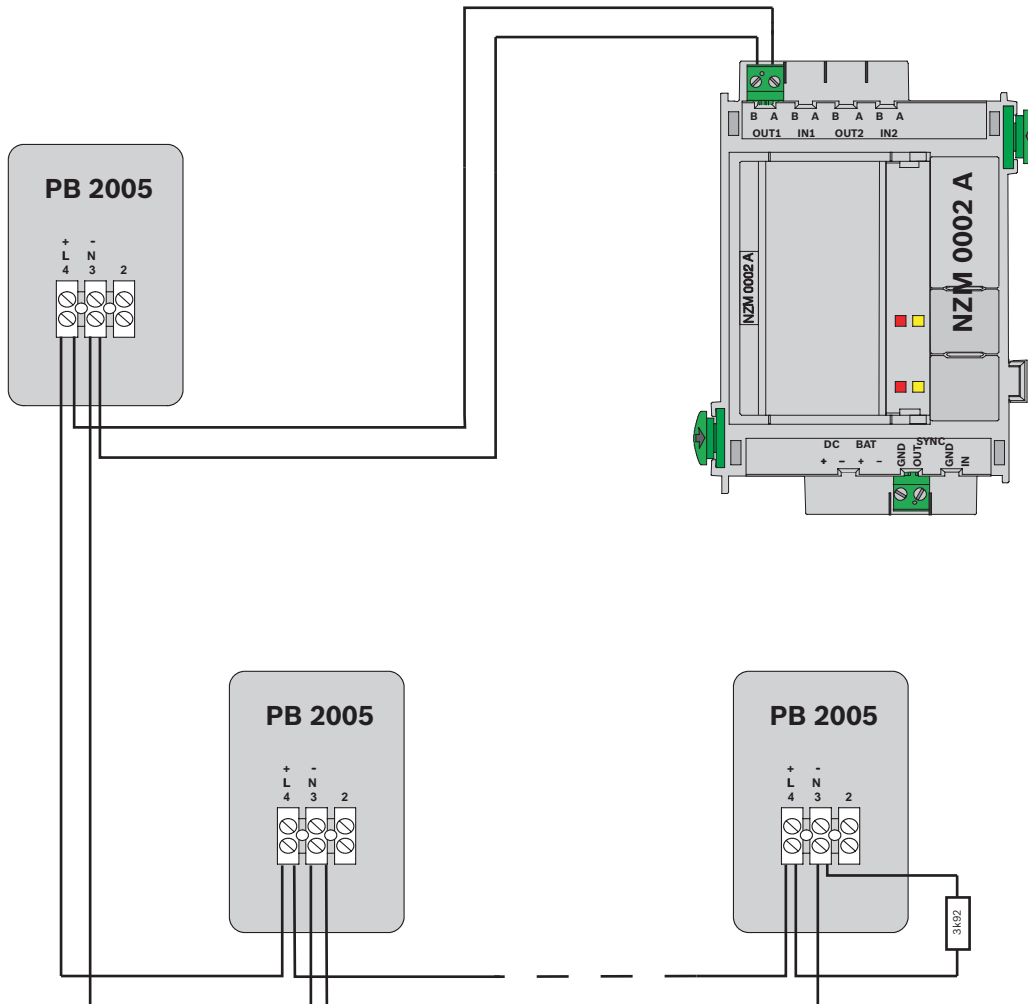
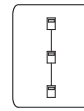



PB 2005

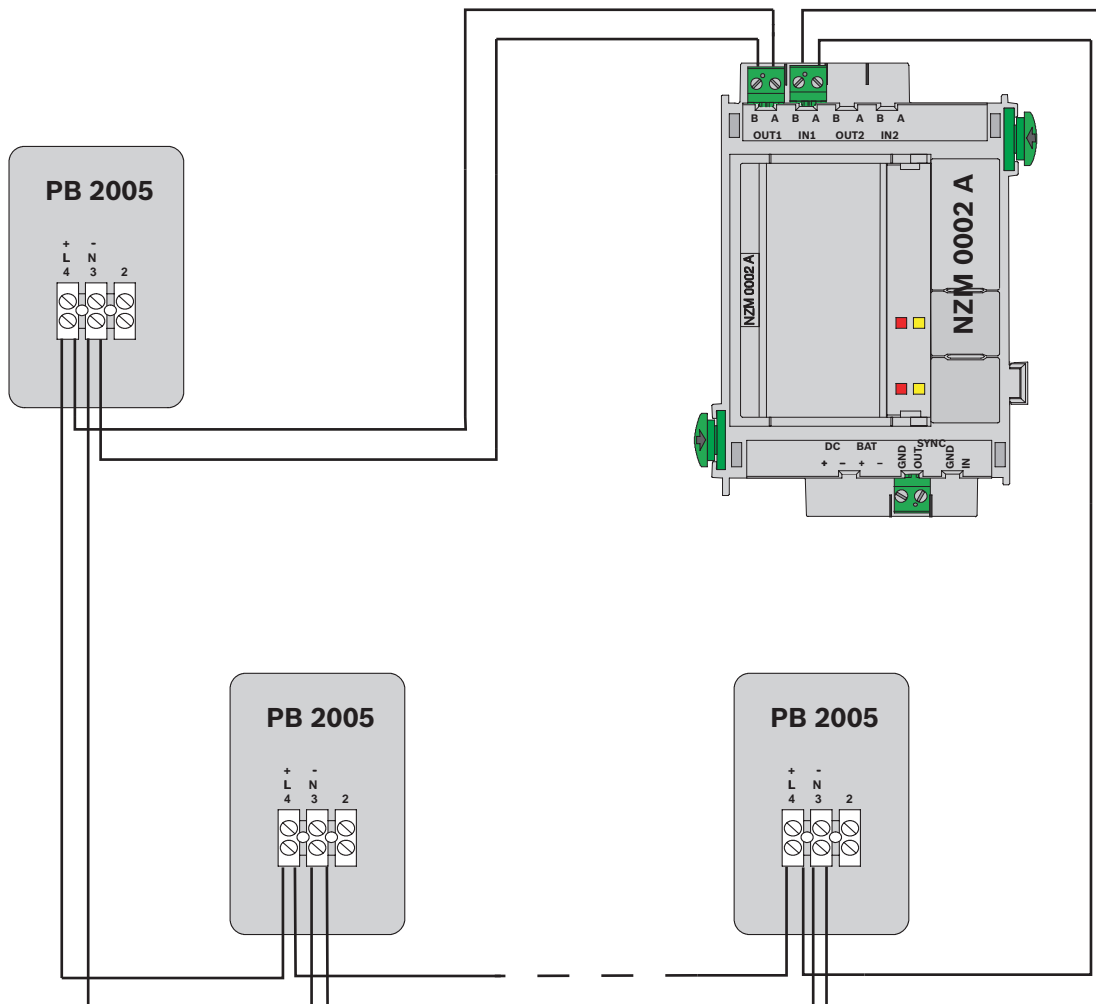
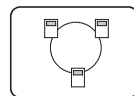

2.4.6

RMH 0002 A

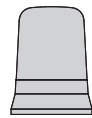

FNS-P400RTH

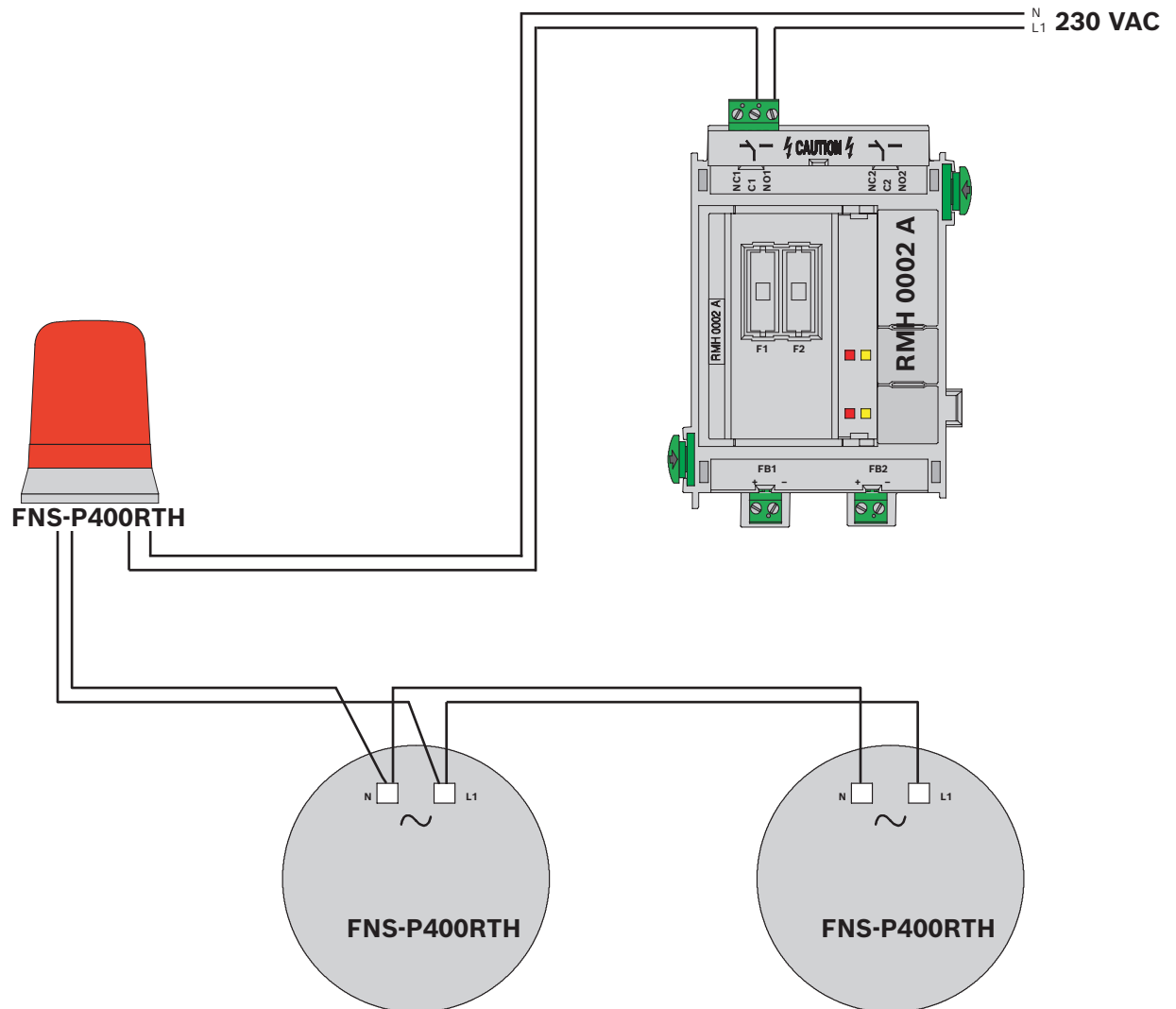
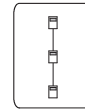

### 2.4.7 IOS 0020 A

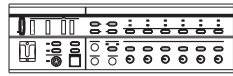
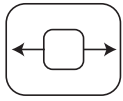

Plena

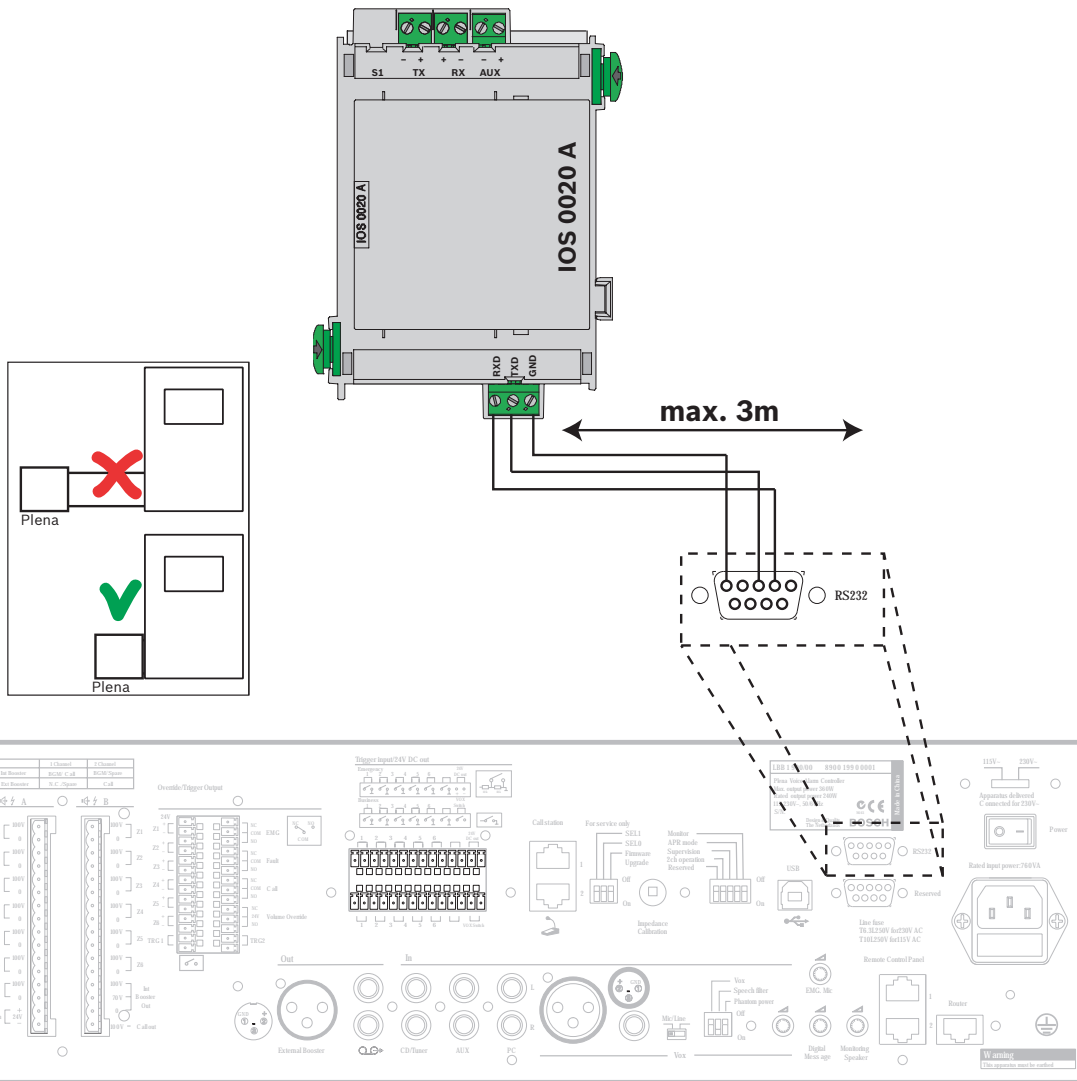



FAT4000 FBF4000 ADP4000

FMF-FAT FMF-FBF-FAT  
FMF-FIBS-A4/-A3  
FMF-ADP

ELS

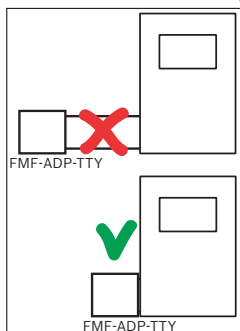
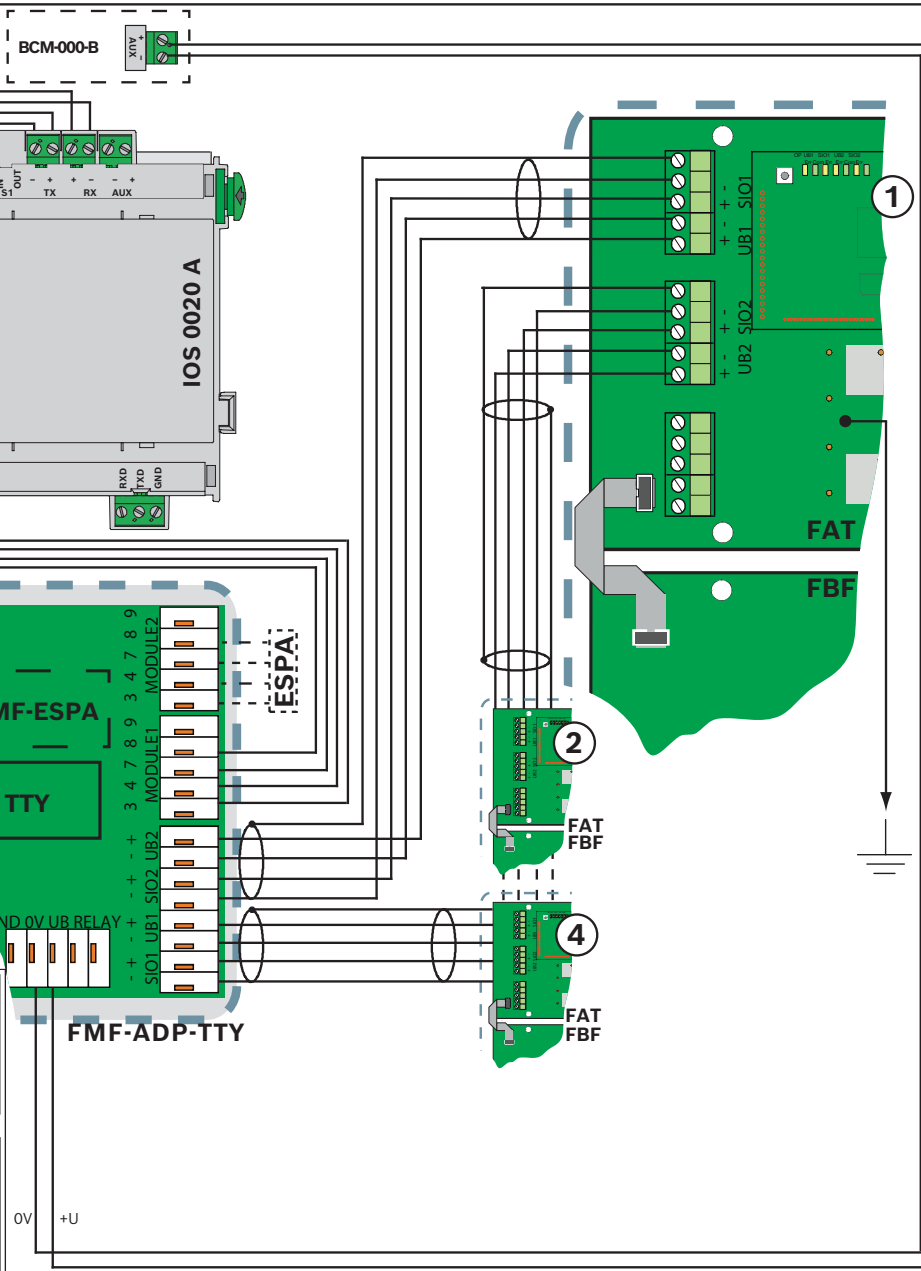

### 2.4.8 FPE-5000-UGM



FAT4000 FBF4000 ADP4000  
 FMF-FAT FMF-FBF-FAT  
 FMF-FIBS-A4/-A3  
 FMF-ADP

ELS

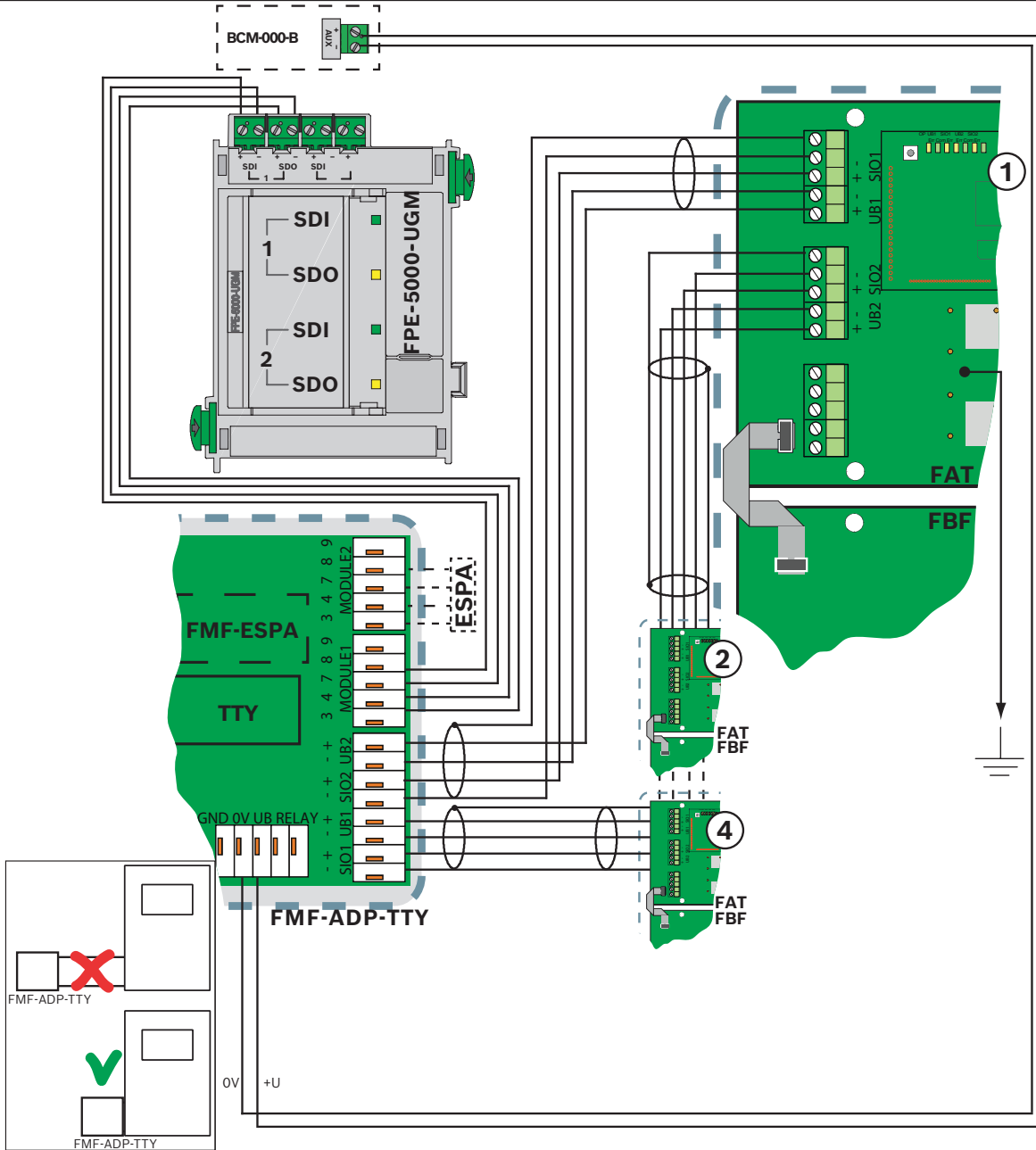



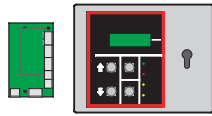

FAT2002RE  
ADP-NE

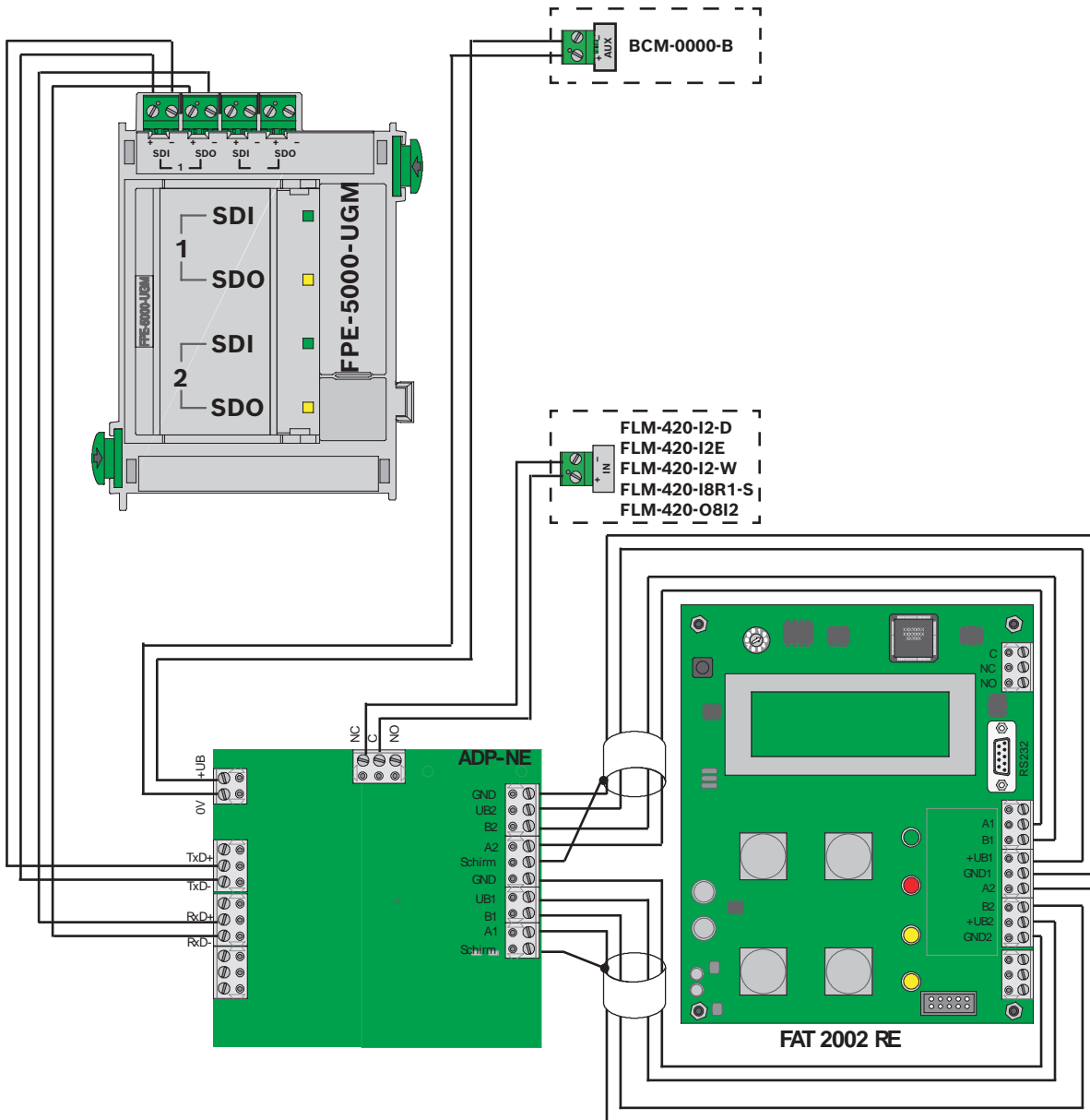

## 2.5 Interface Modules



*FLM-420-4/CON-D/S, pagina 125*

*FLM-420-I8R1-S, pagina 158*

*FLM-420-NAC-D/S, pagina 160*

*FLM-420-RHV, pagina 172*

*FLM-420-RLE-S, pagina 184*

*FLM-420-RLV1-E, pagina 185*

*FLM-420-RLV8-S, pagina 186*

*FMF-ADP-FBF/FMF-ADP-TTY, pagina 187*

### 2.5.1 FLM-420-4/CON-D/S

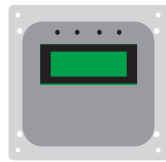

ALARMLINE II

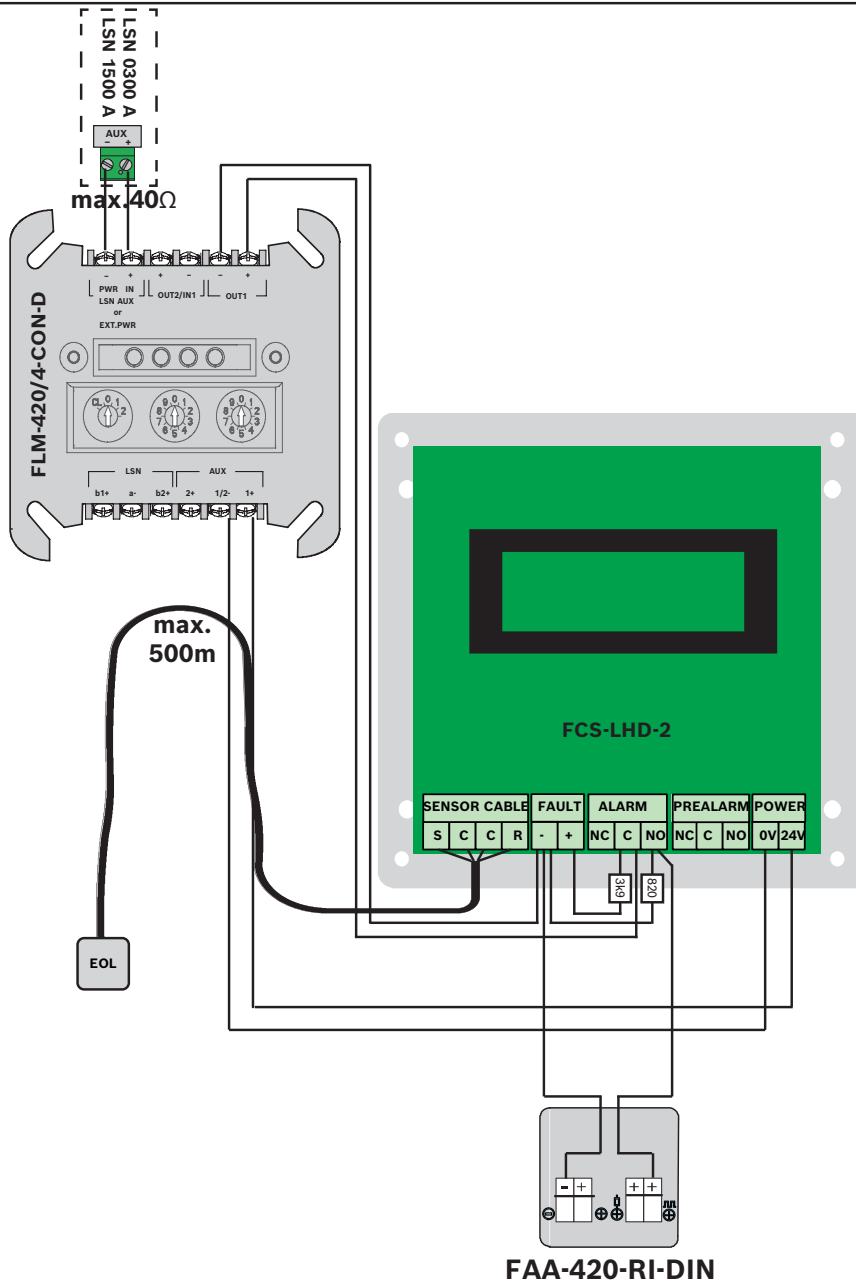
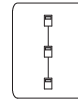

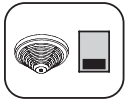

FCS-LWM-1

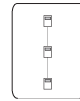

ELS

BCM-0000-B  
LSN 0300 A  
LSN 1500 A

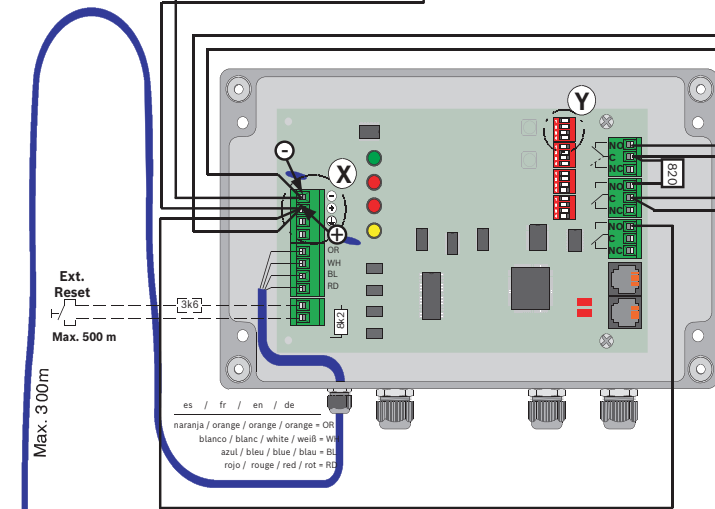
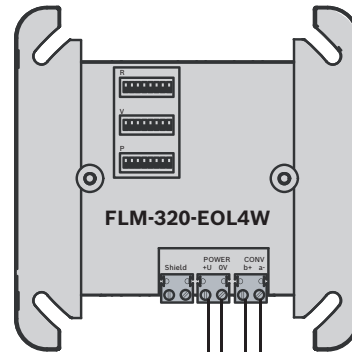
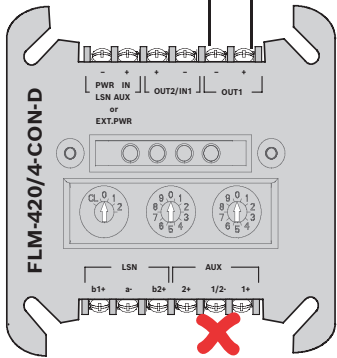

es / fr / en / de  
naranja / orange / orange / orange = OR  
blanco / blanc / white / weiß = WH  
azul / bleu / blue / blau = BL  
rojo / rouge / red / rot = RE





FCS-LWM-1

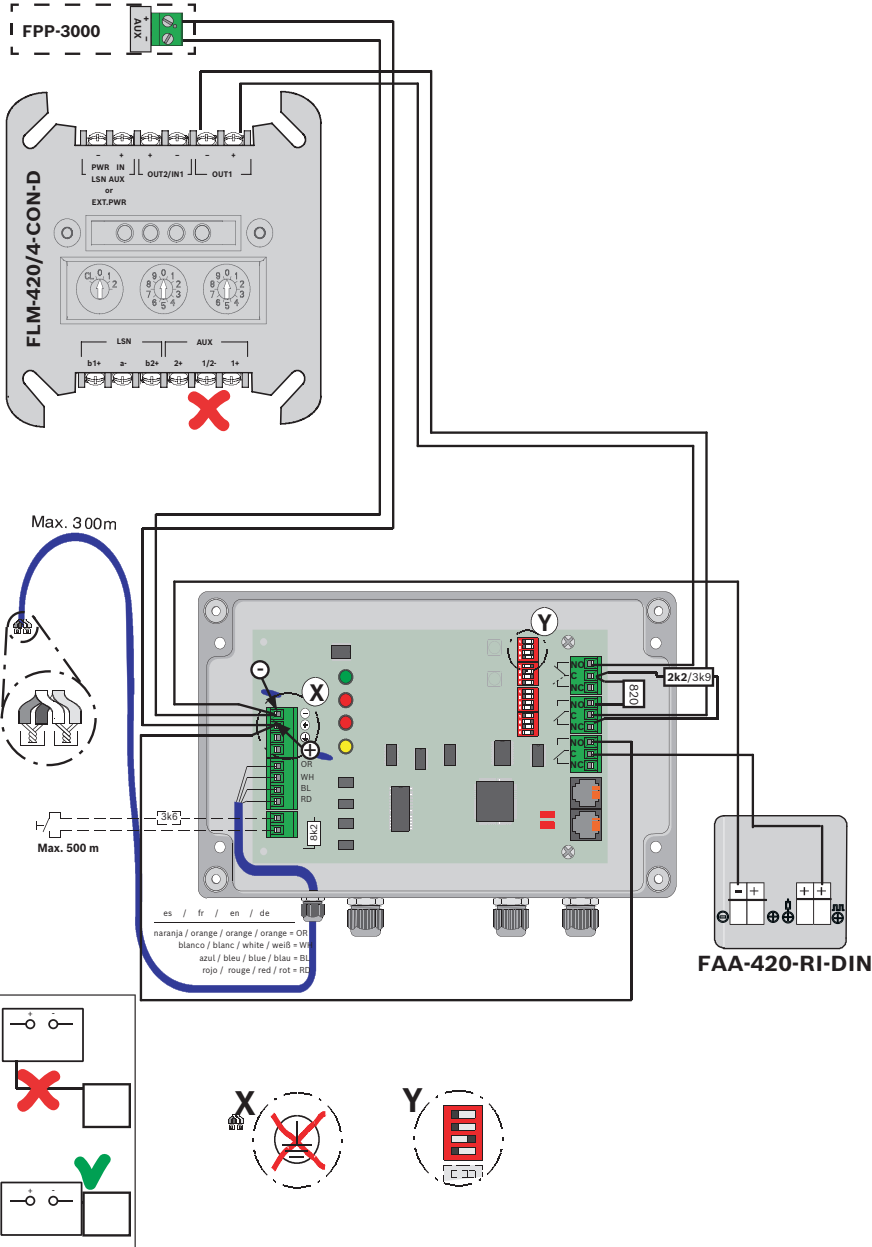





FCA-500-EU  
 FCP-O 500  
 FCP-O 500-P  
 FCP-OC 500  
 FCP-OC 500-P

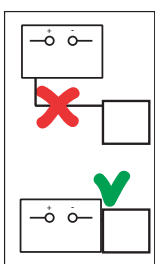
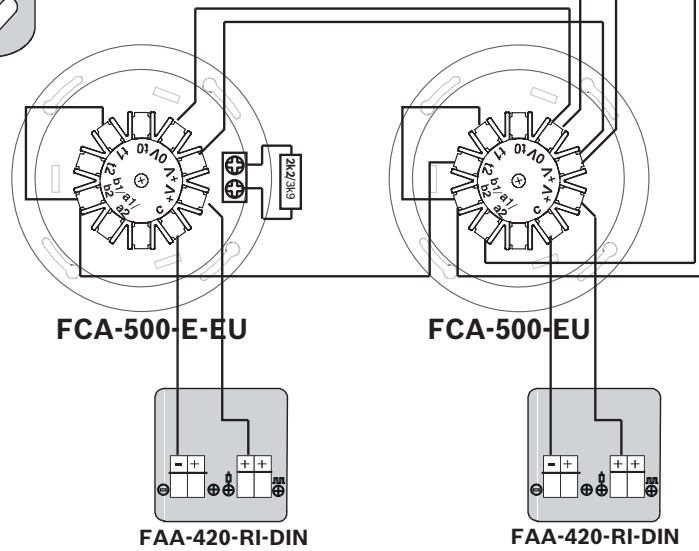
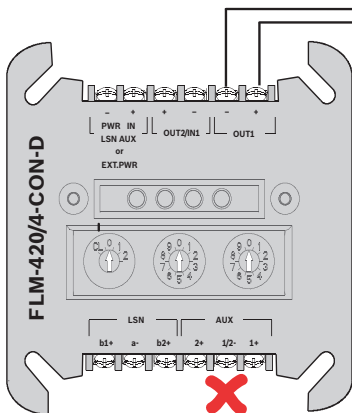

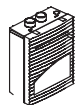

FCS-320-TM Series



BCM-0000-B  
LSN 0300 A  
LSN 1500 A

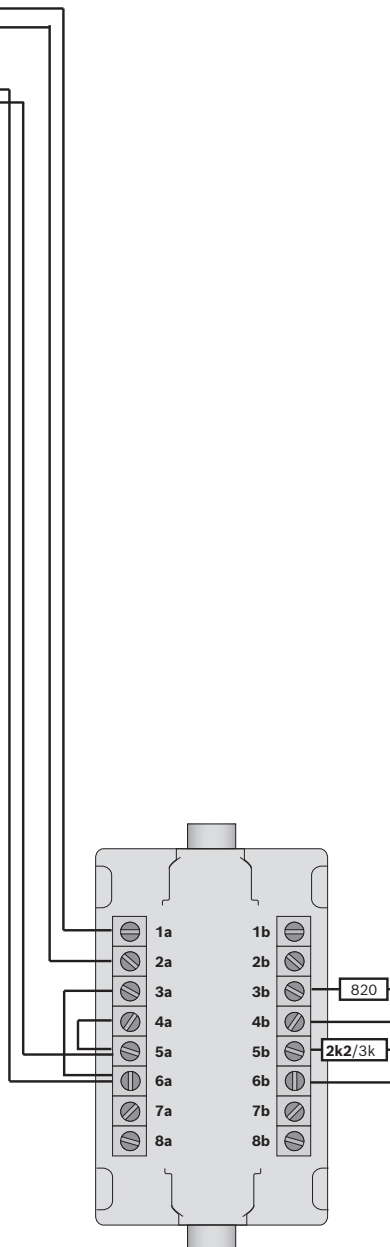
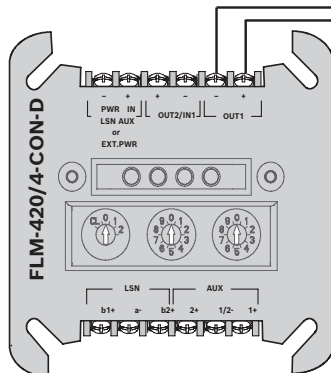



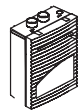

FCS-320-TP Series

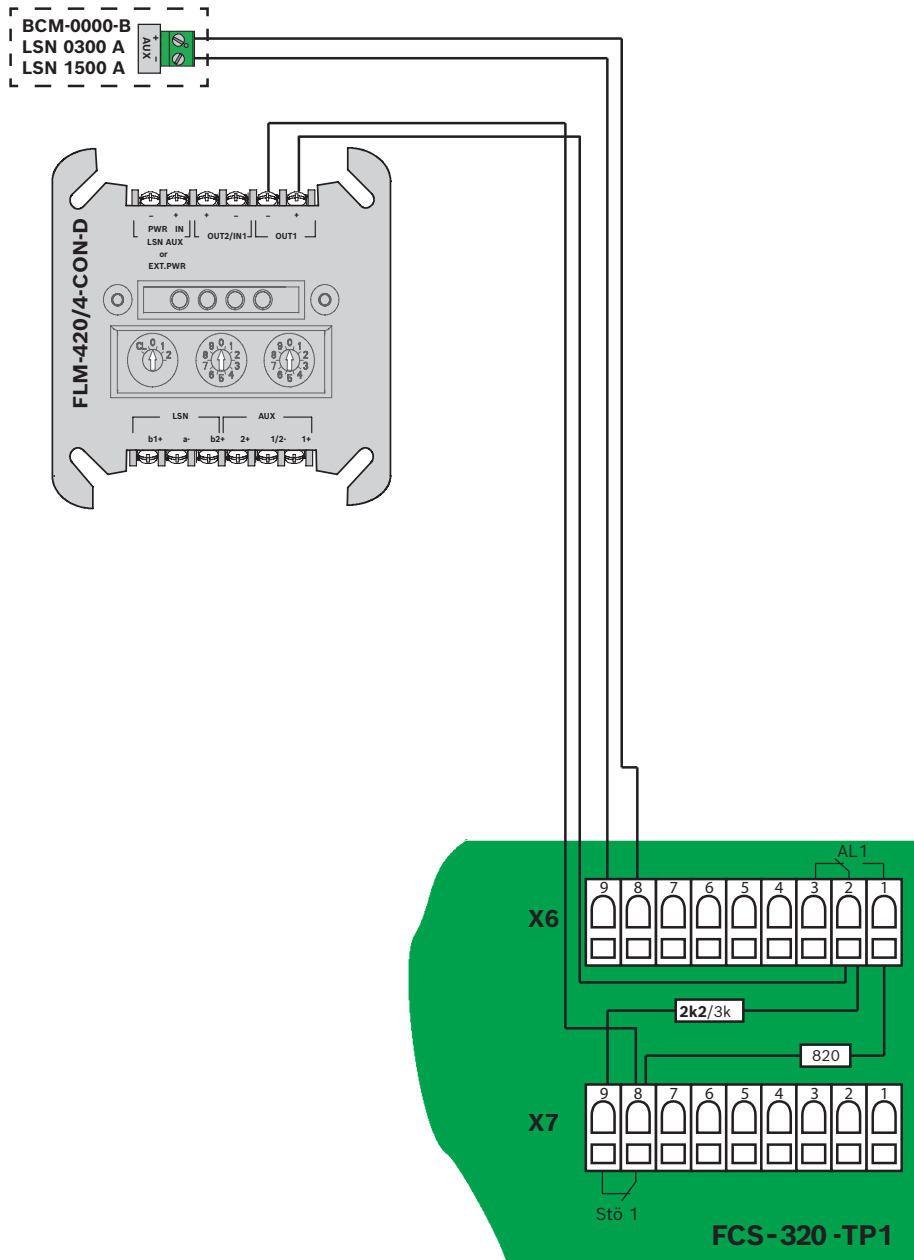
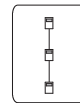

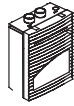

FCS-320-TP Series

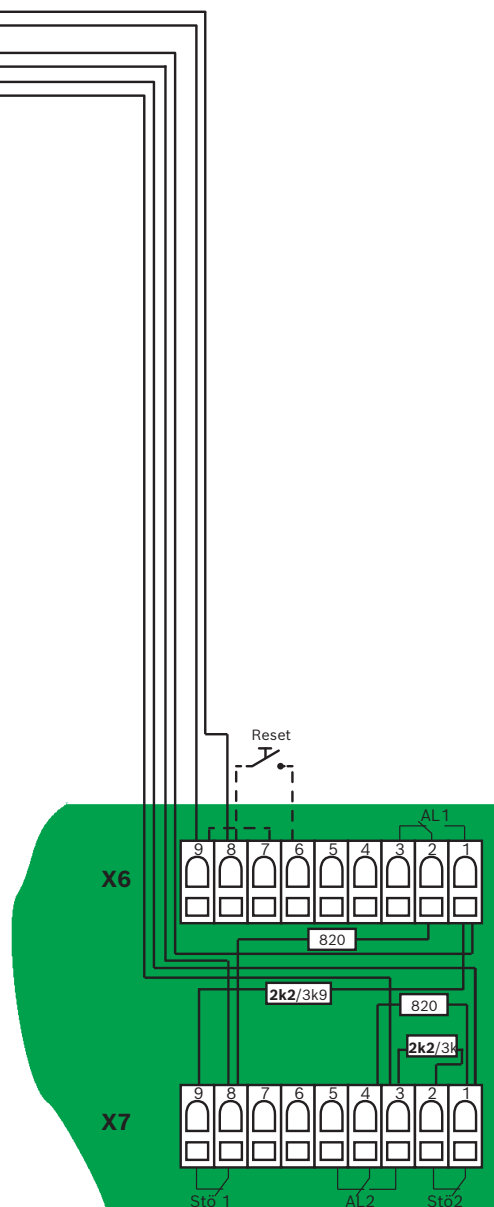
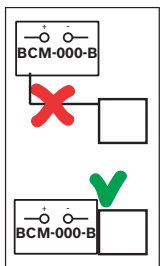
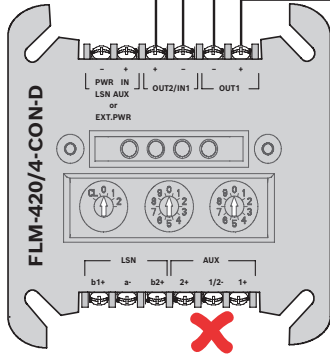
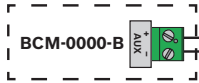

FCS-320-TP2

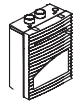

**FCS-320-TP1**

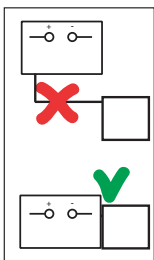
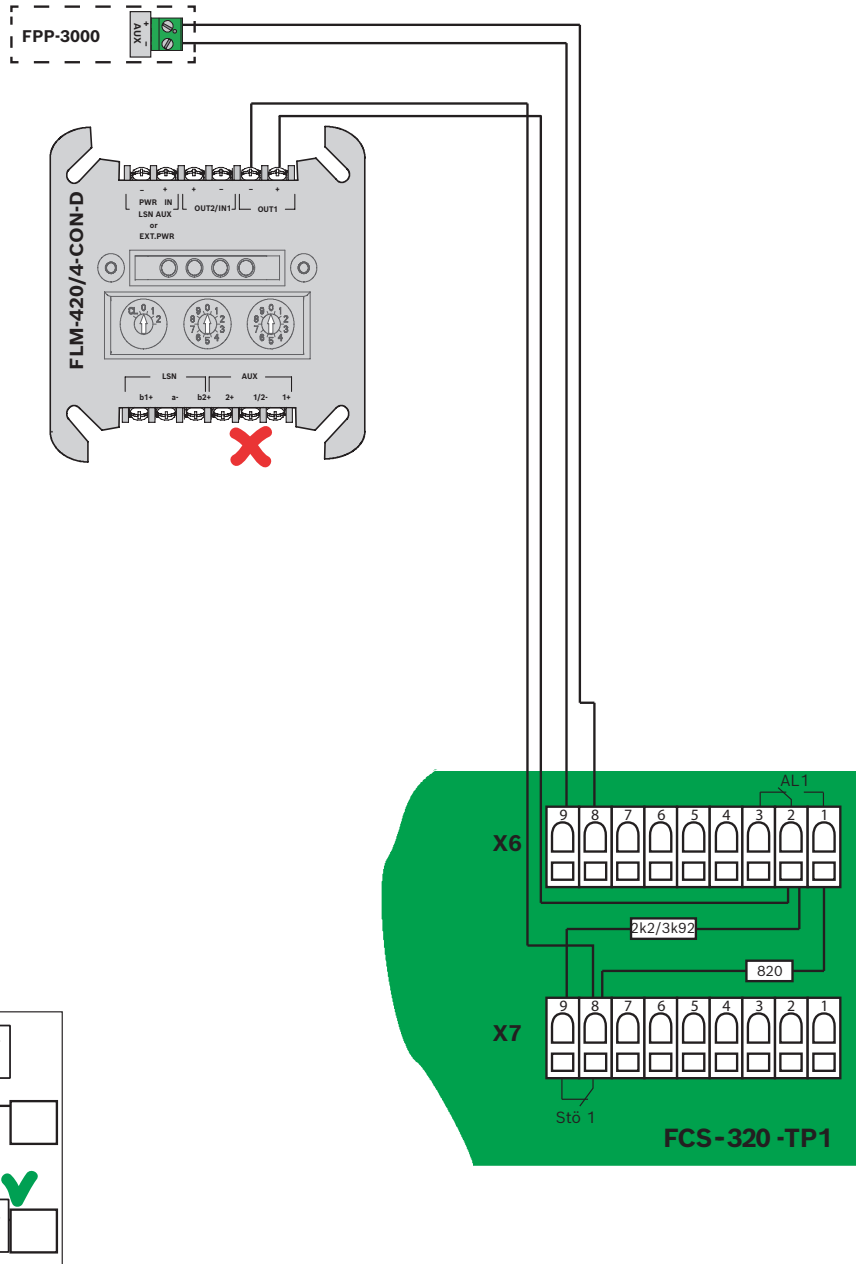

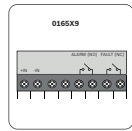

**016519, 016589  
IR3 Flame Detector**

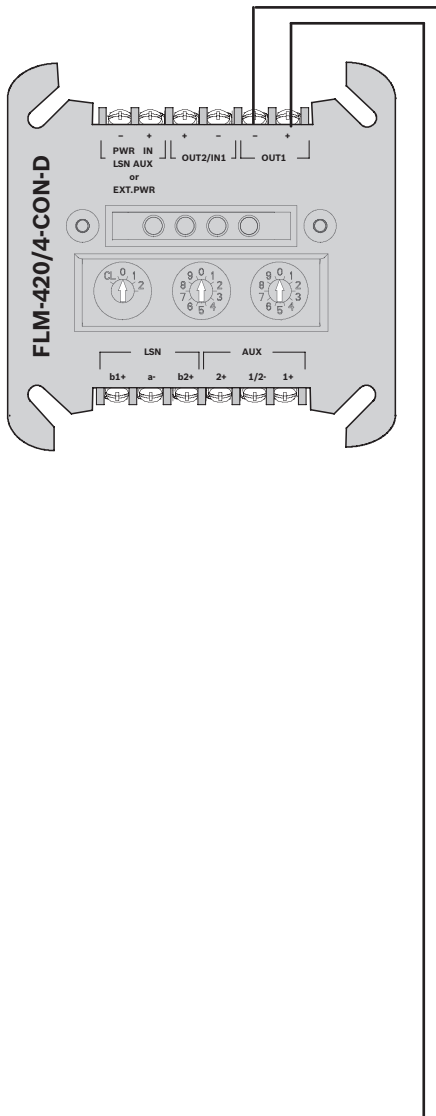
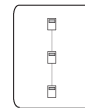

**max. 1 x 0165X9**

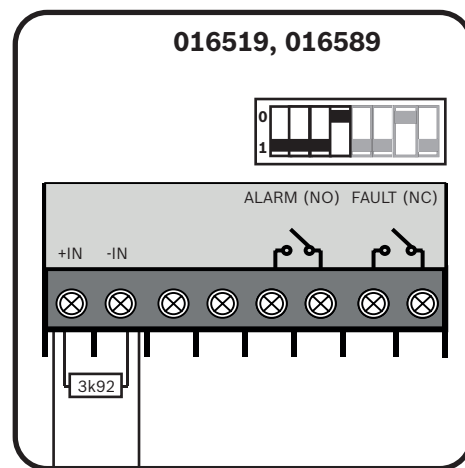

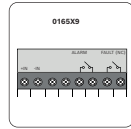

**016519, 016589  
IR3 Flame Detector**

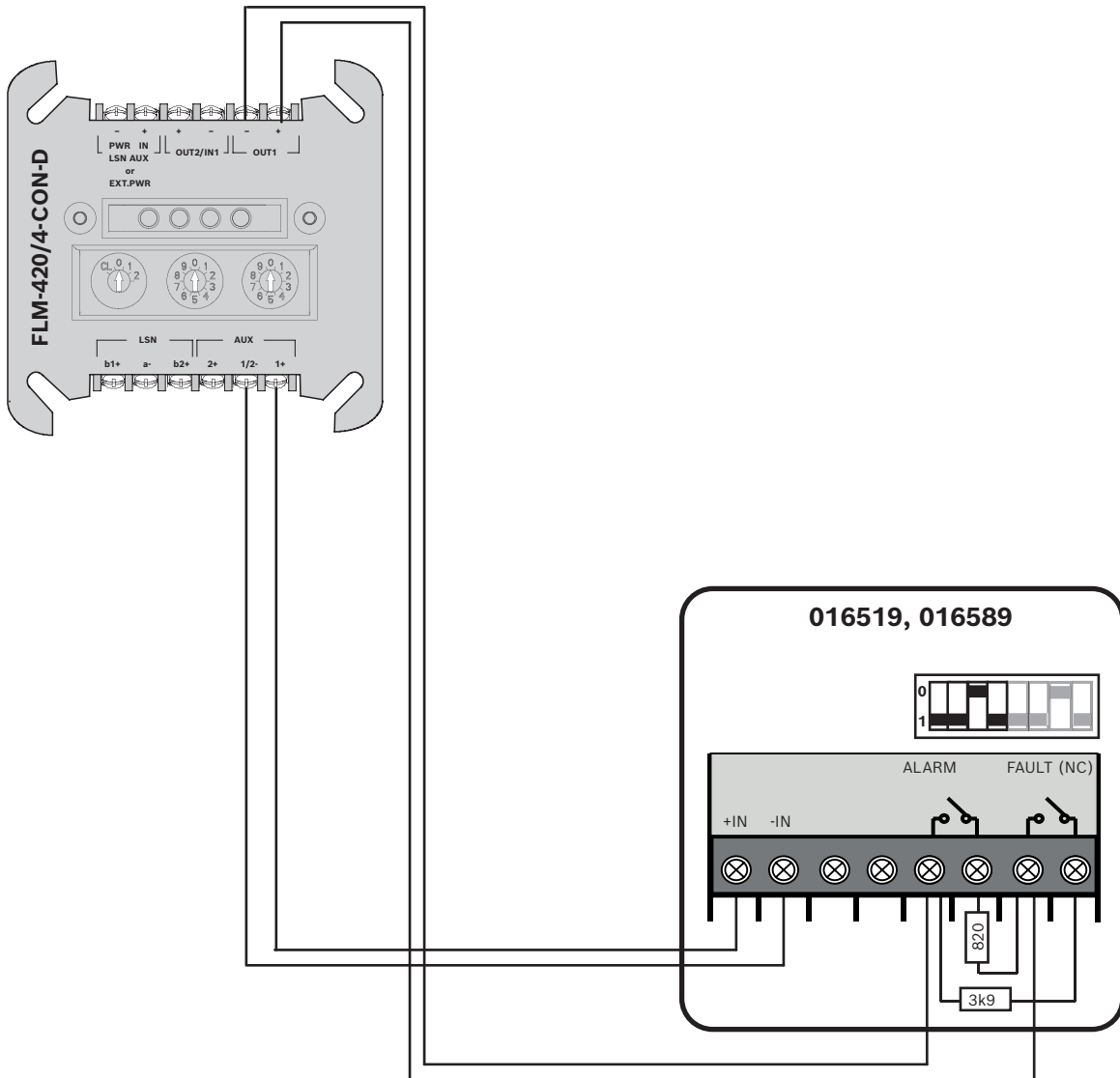
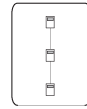

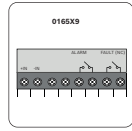

**016519, 016589  
IR3 Flame Detector**

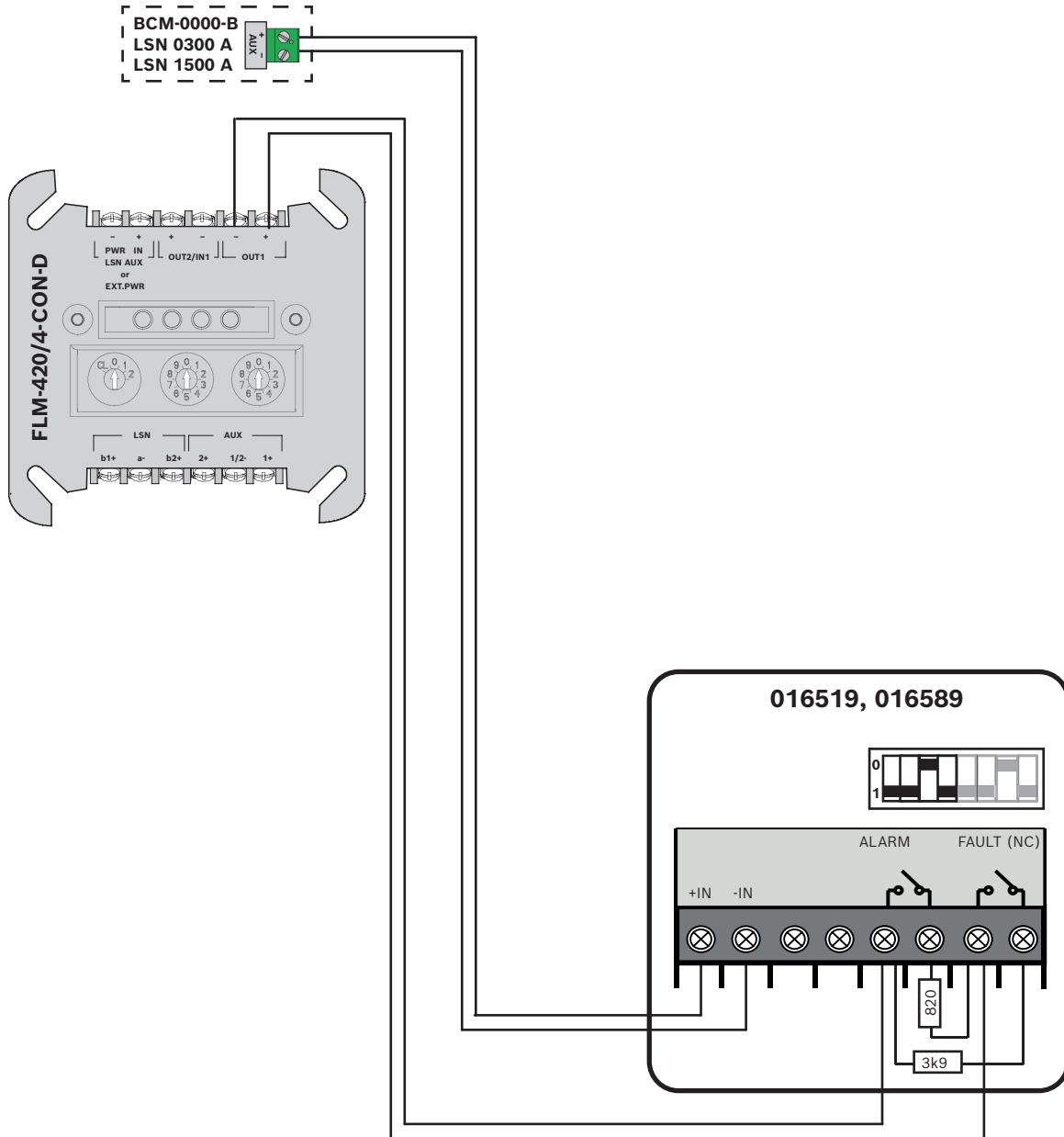
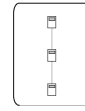

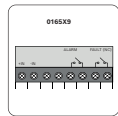

**016519, 016589  
IR3 Flame Detector**

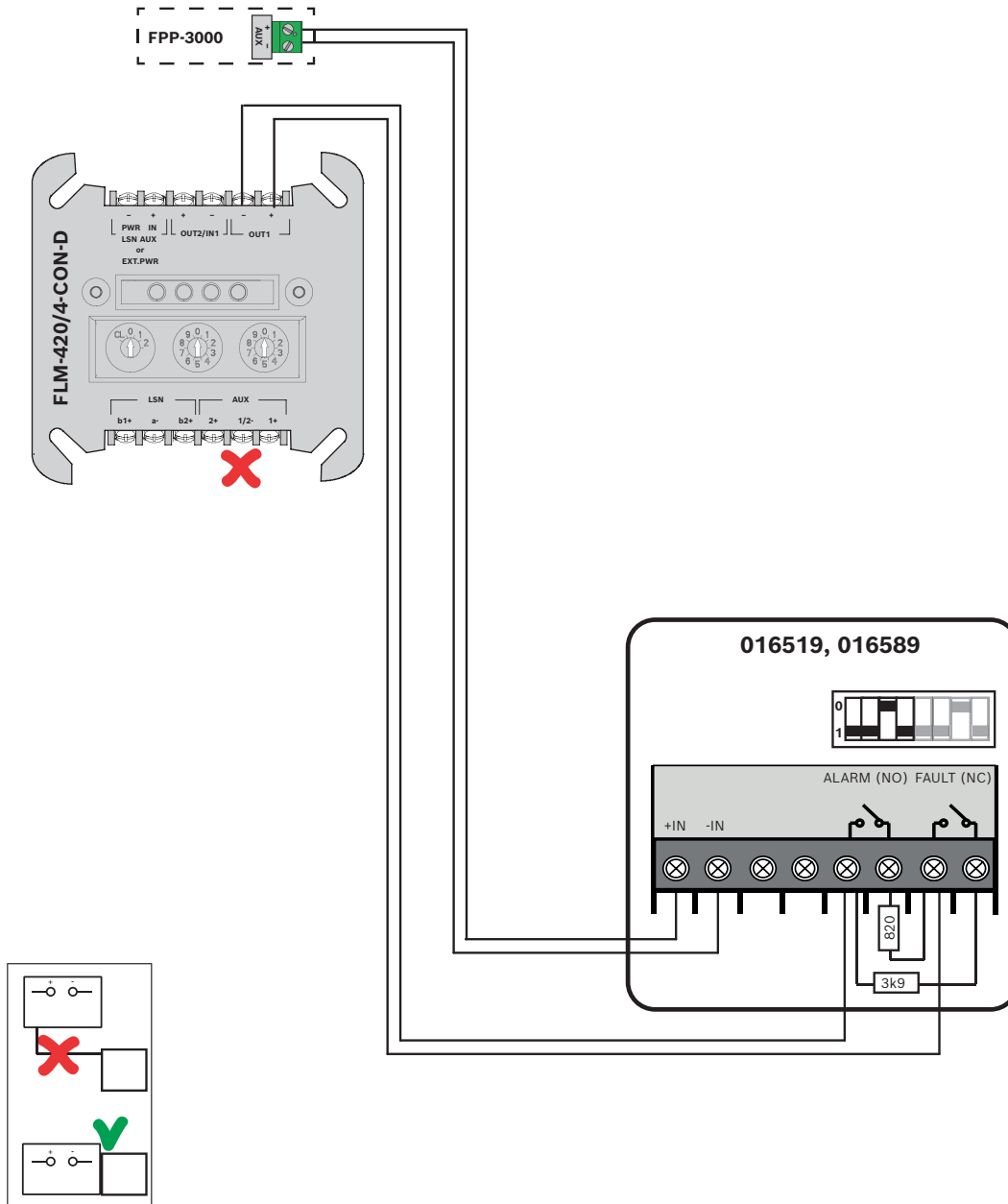



**Fireray 50RV  
Fireray 100RV**

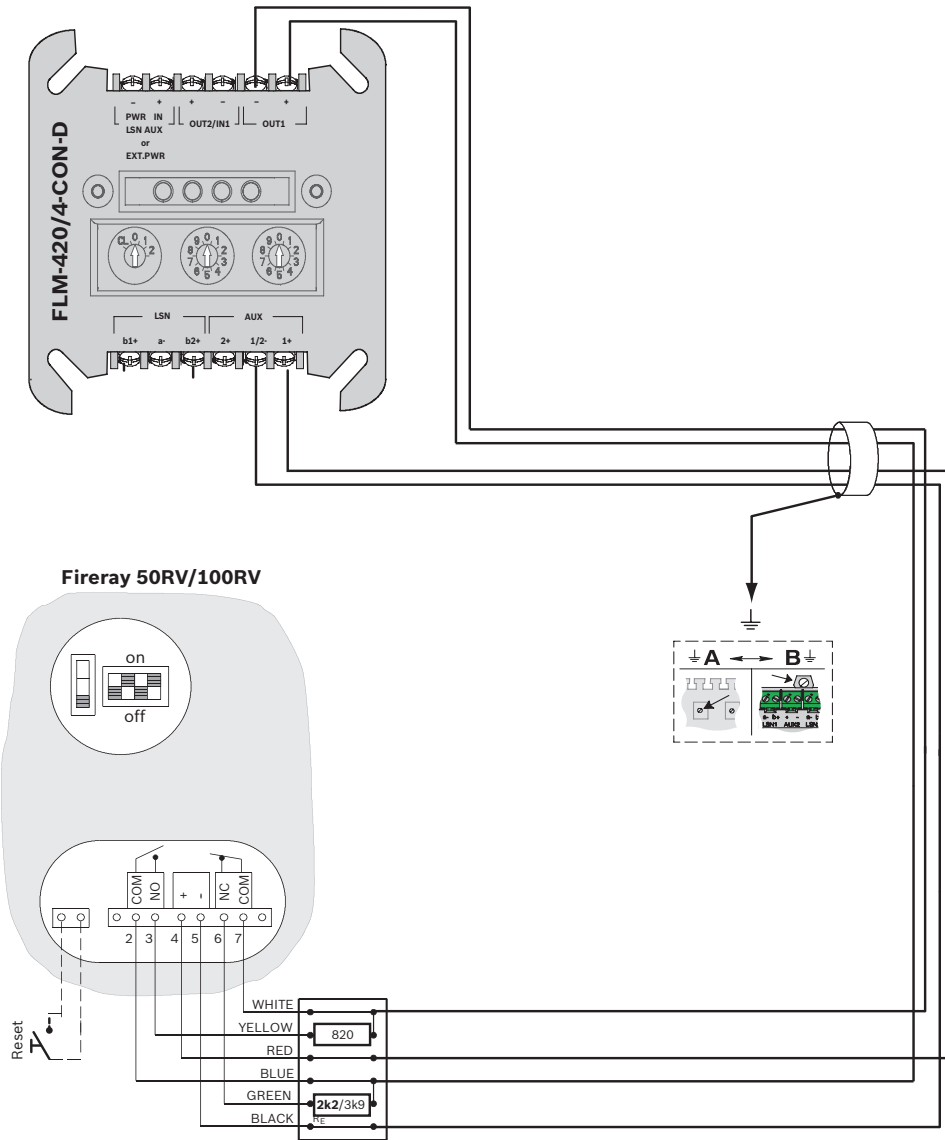
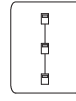





**FIRERAY3000**

1 x

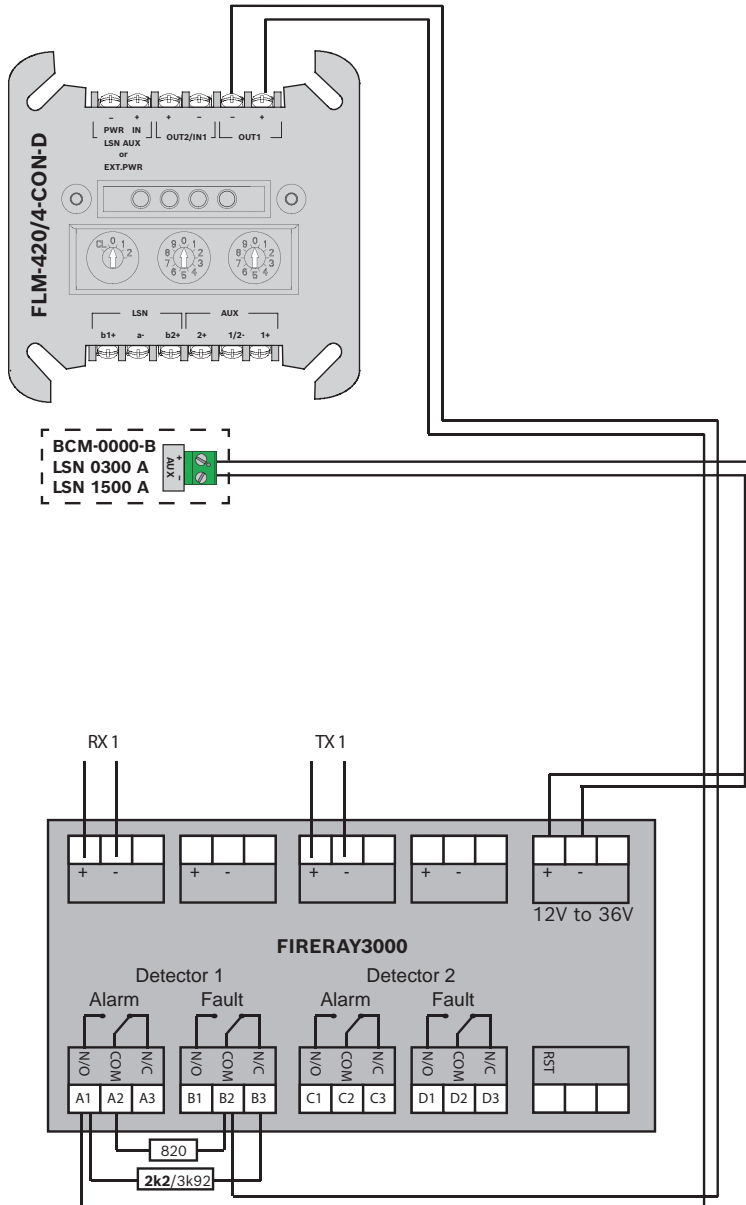



**FIRERAY3000**  
2 x **OUT1**

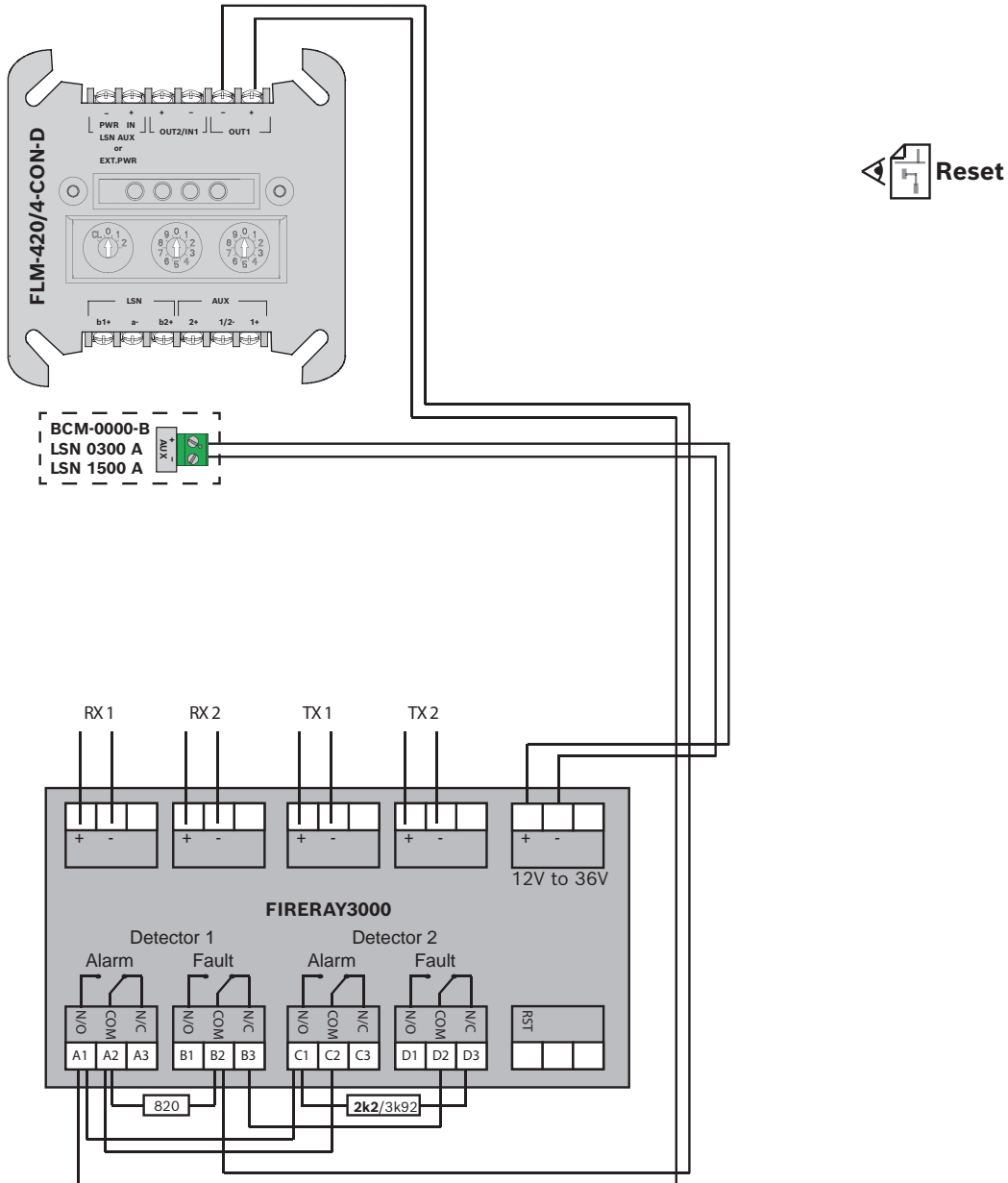



**FIRERAY3000**

**2 x**  **OUT1+2**

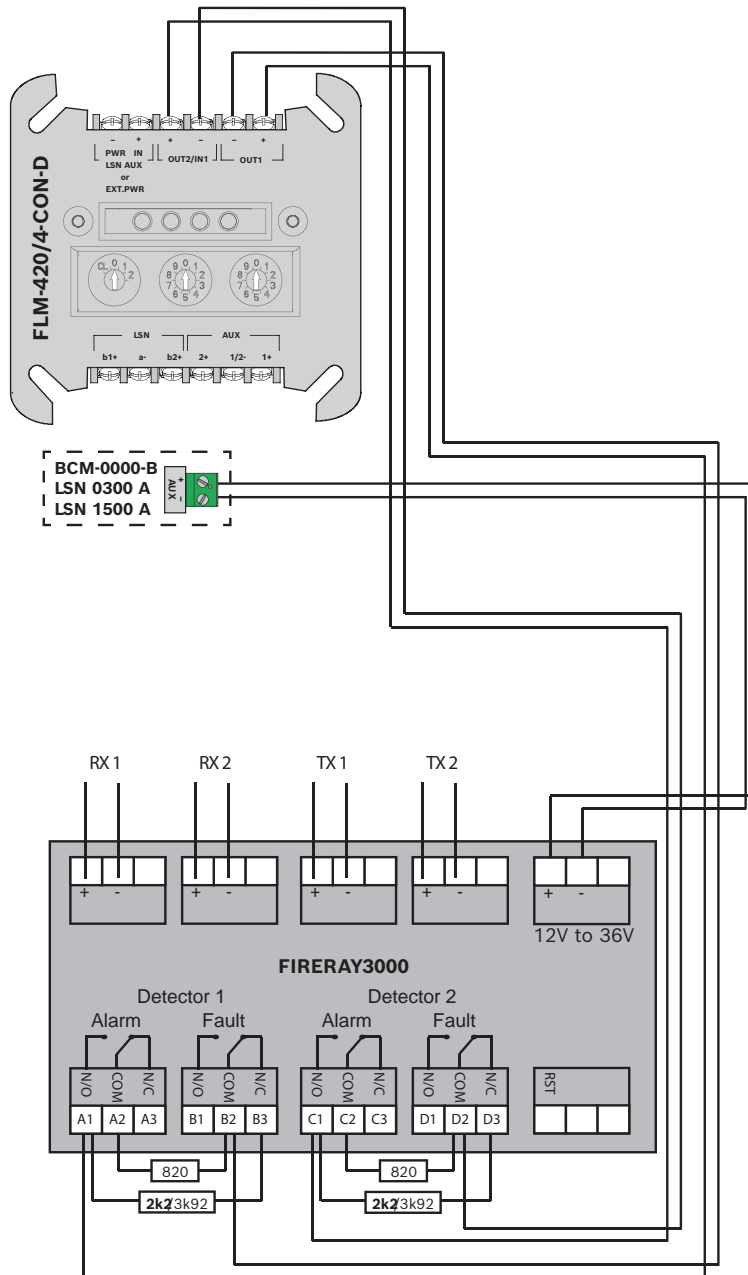

 **Reset action**



**FIRERAY5000**

1 x

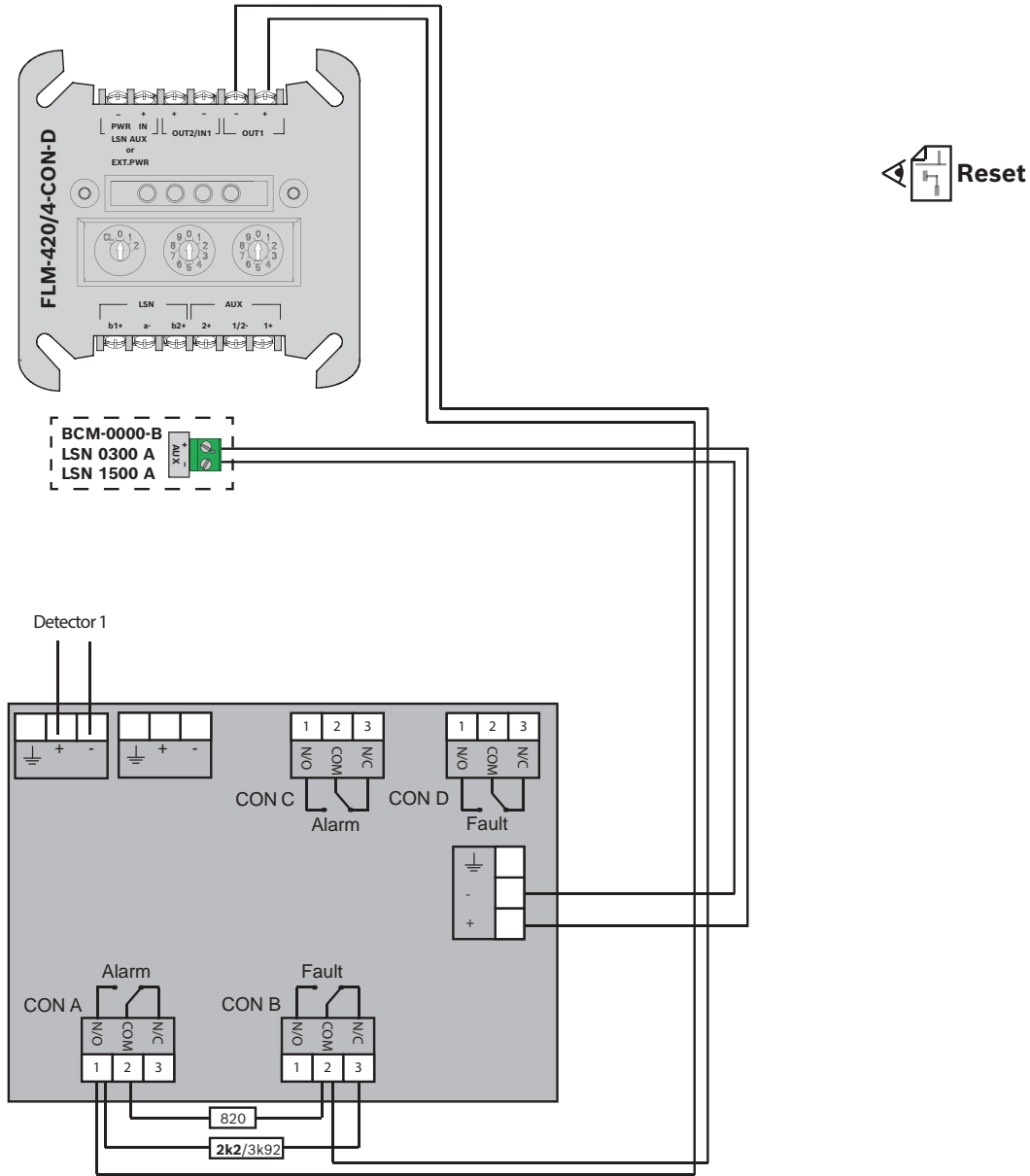



**FIRERAY5000**

**2 x OUT1**

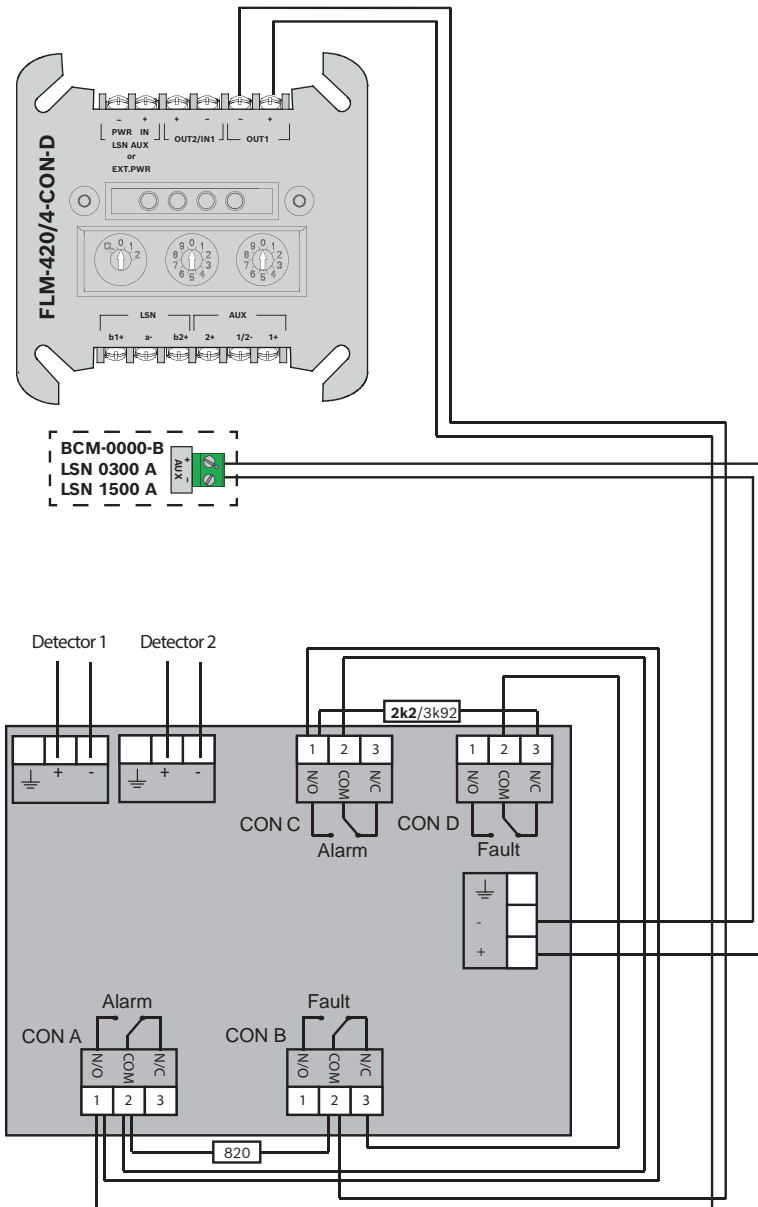



**Fireray 50RV  
Fireray 100RV**

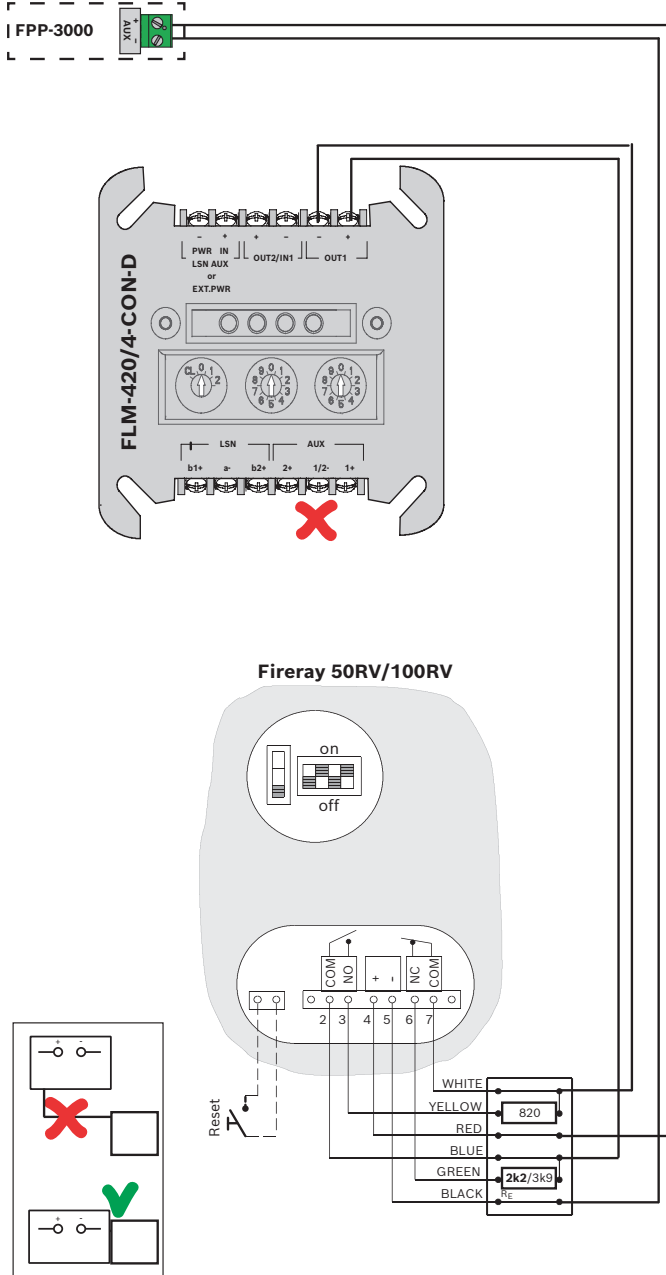



**FIRERAY3000**

1 x

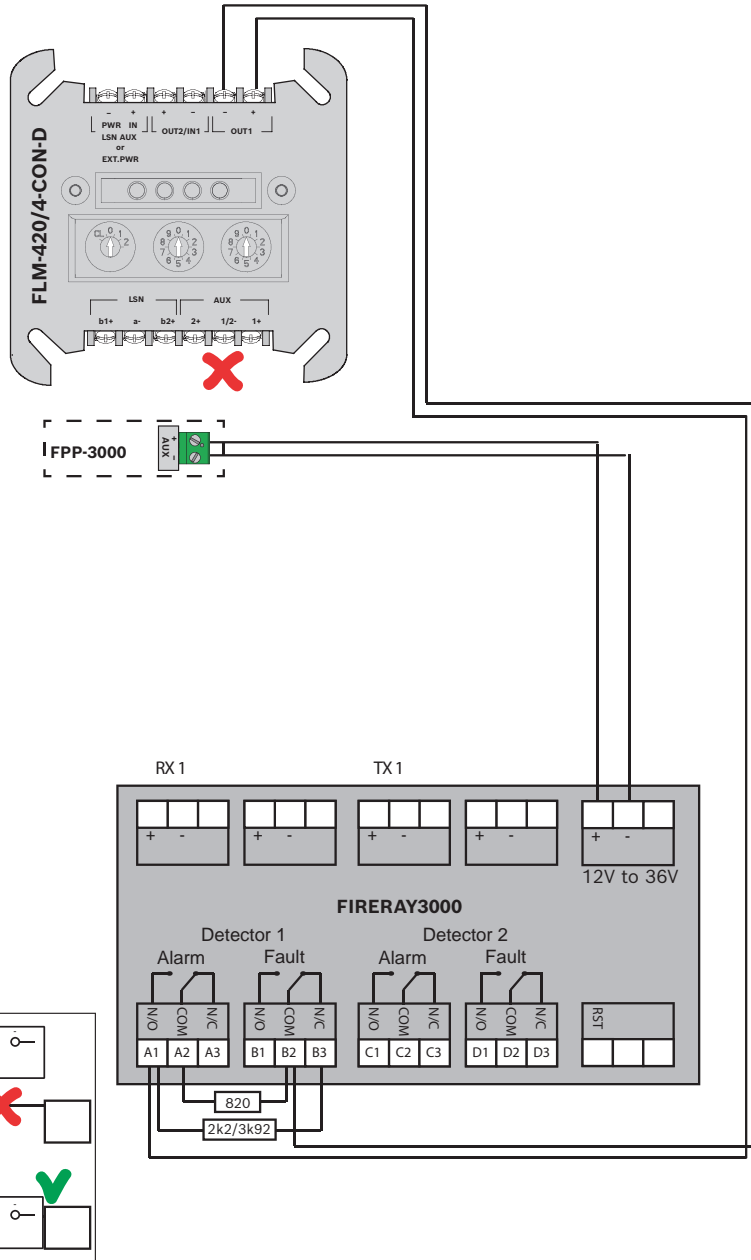

**Reset action**

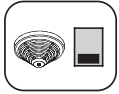

**FIRERAY3000**

2 x  **OUT1**

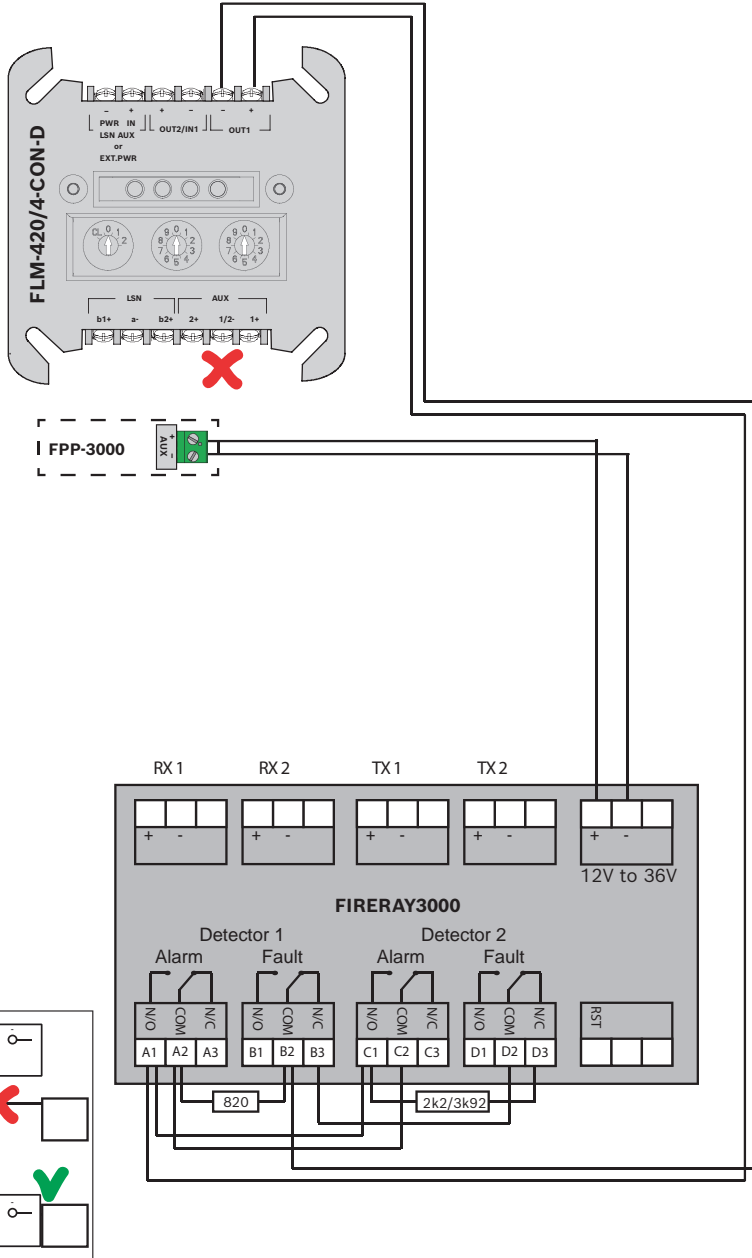

 **Reset action**



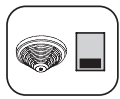

**FIRERAY5000**

1 x

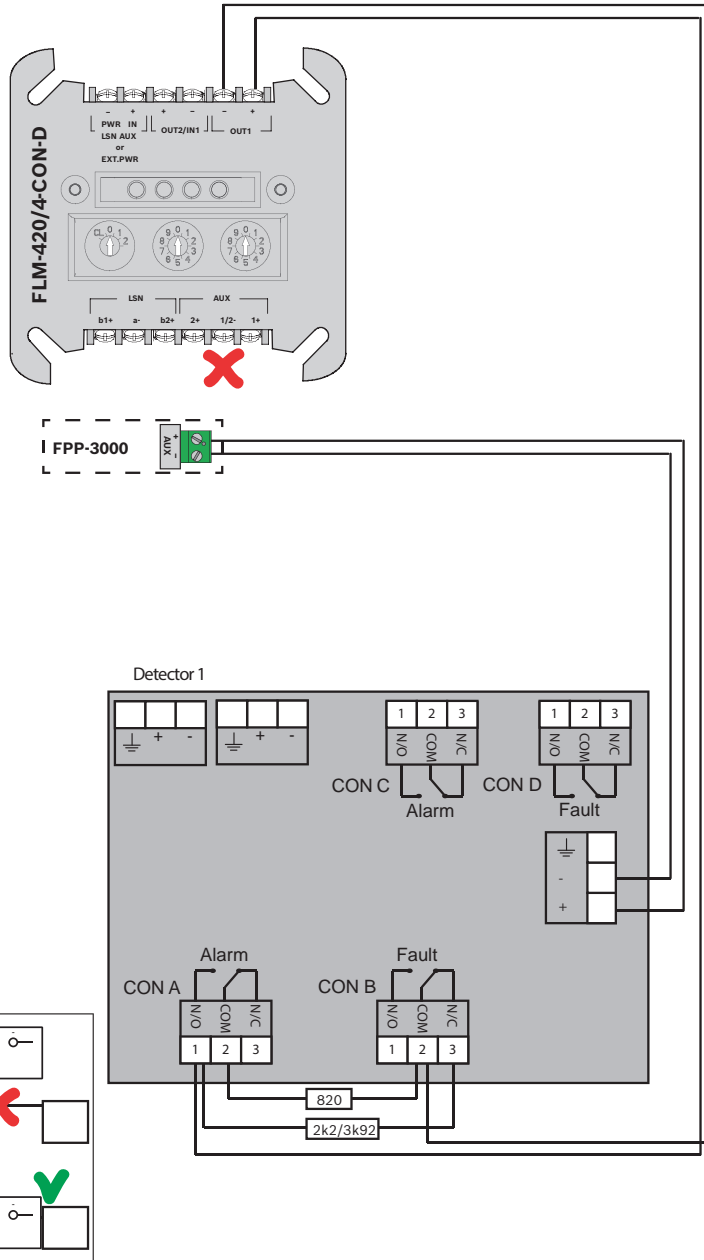

Reset action



**FIRERAY5000**

**2 x OUT1**

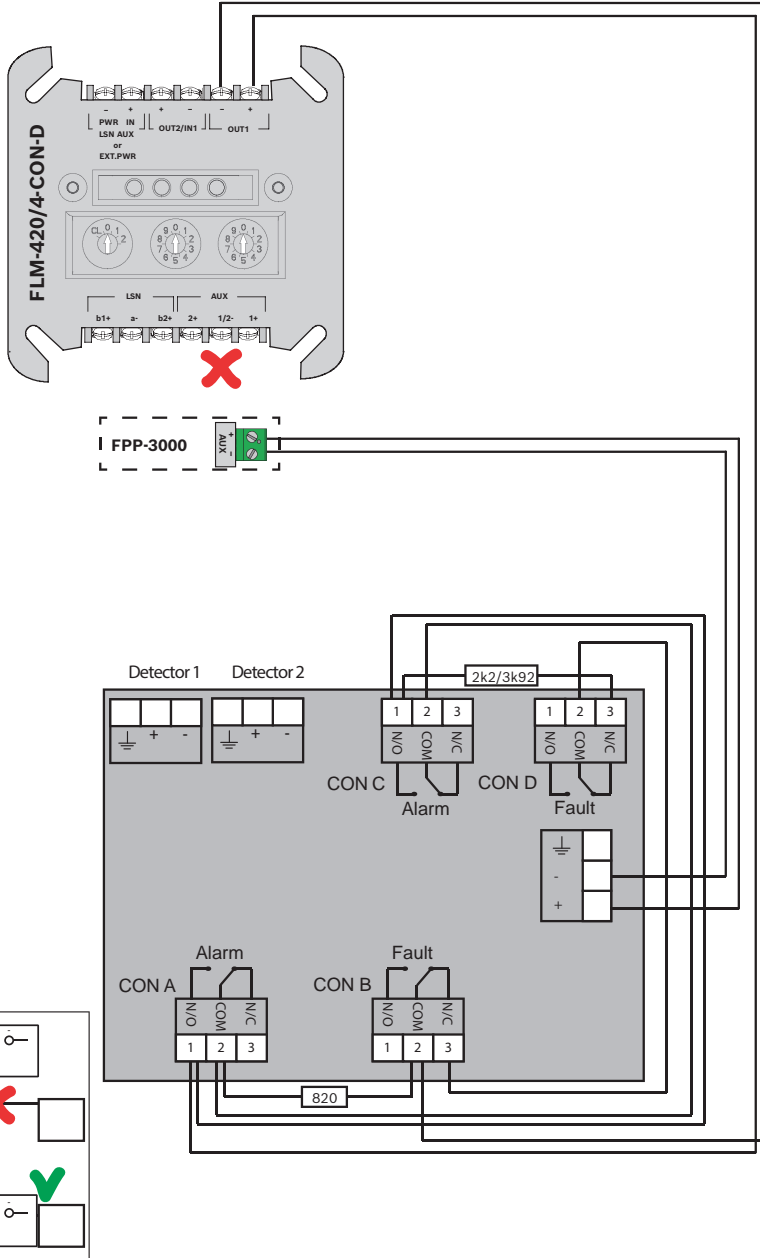

**Reset action**

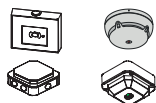

DC1192, SB3  
OOH740-A9-Ex  
DO1101A-Ex  
DT1101A-Ex-  
/DT1102A-Ex  
DF1101-Ex

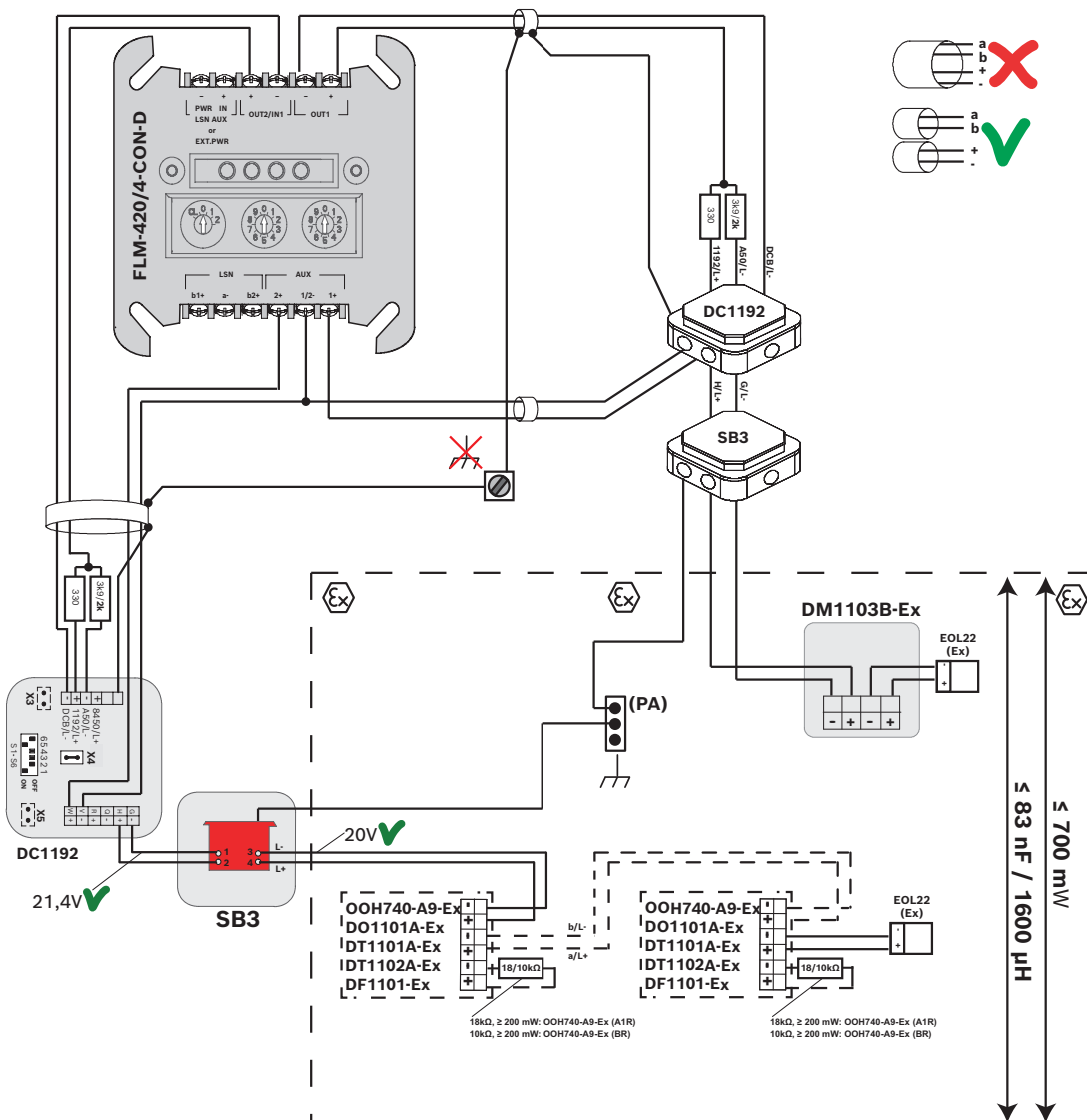



DC1192, SB3  
 OOH740-A9-Ex  
 DO1101A-Ex  
 DT1101A-Ex/DT1102A-Ex  
 DF1101-Ex  
 DM1103B-Ex

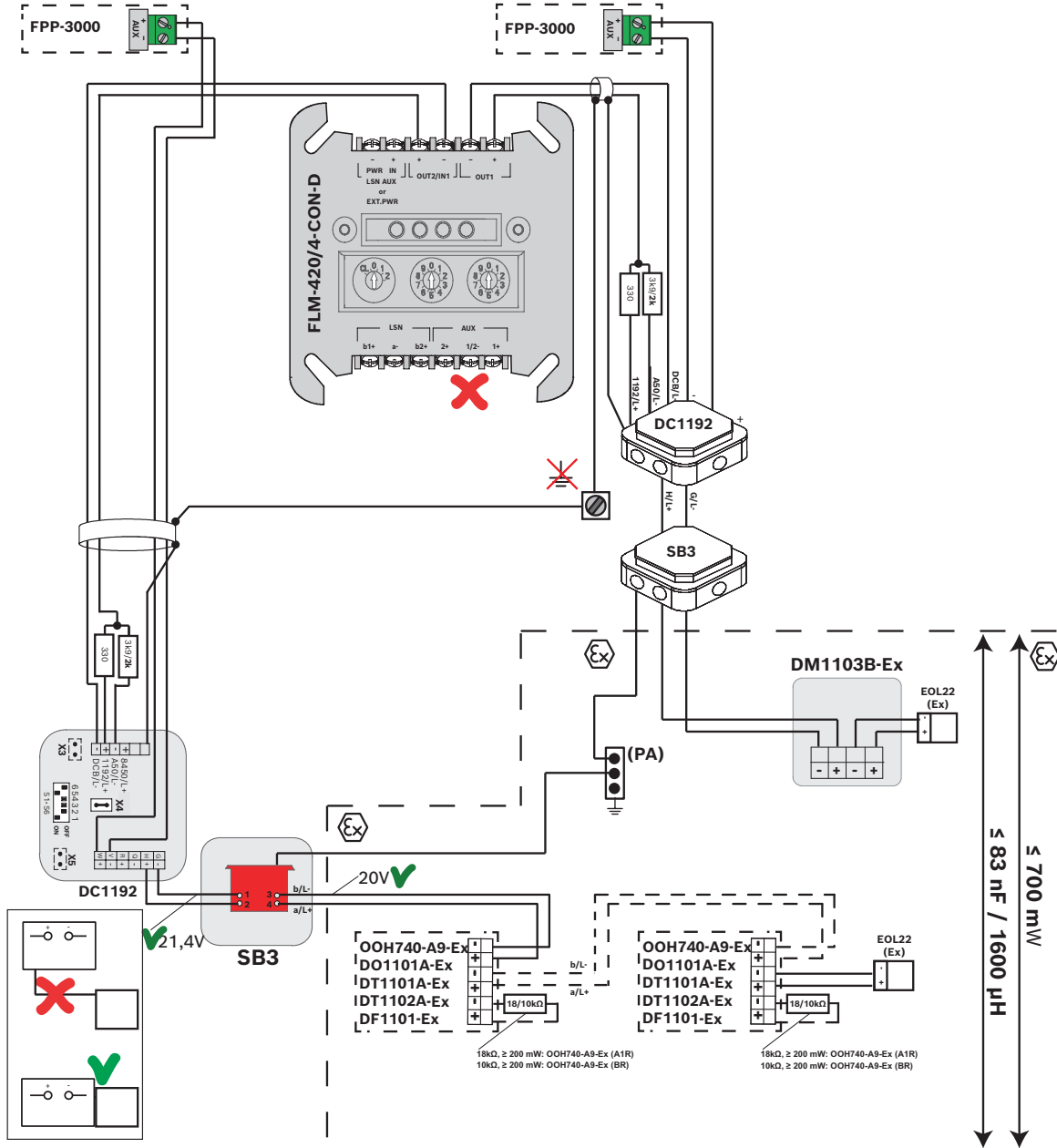

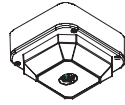

**DF 1192**

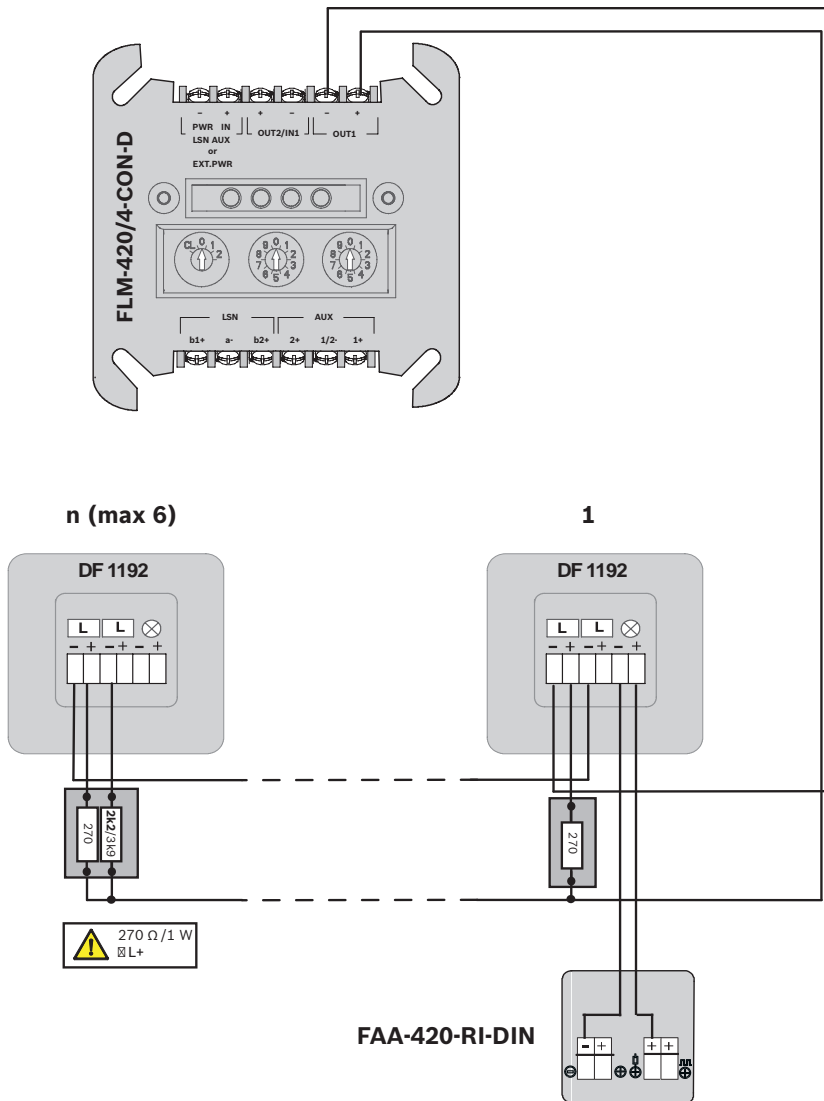

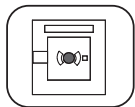

**FMC-300-RW**

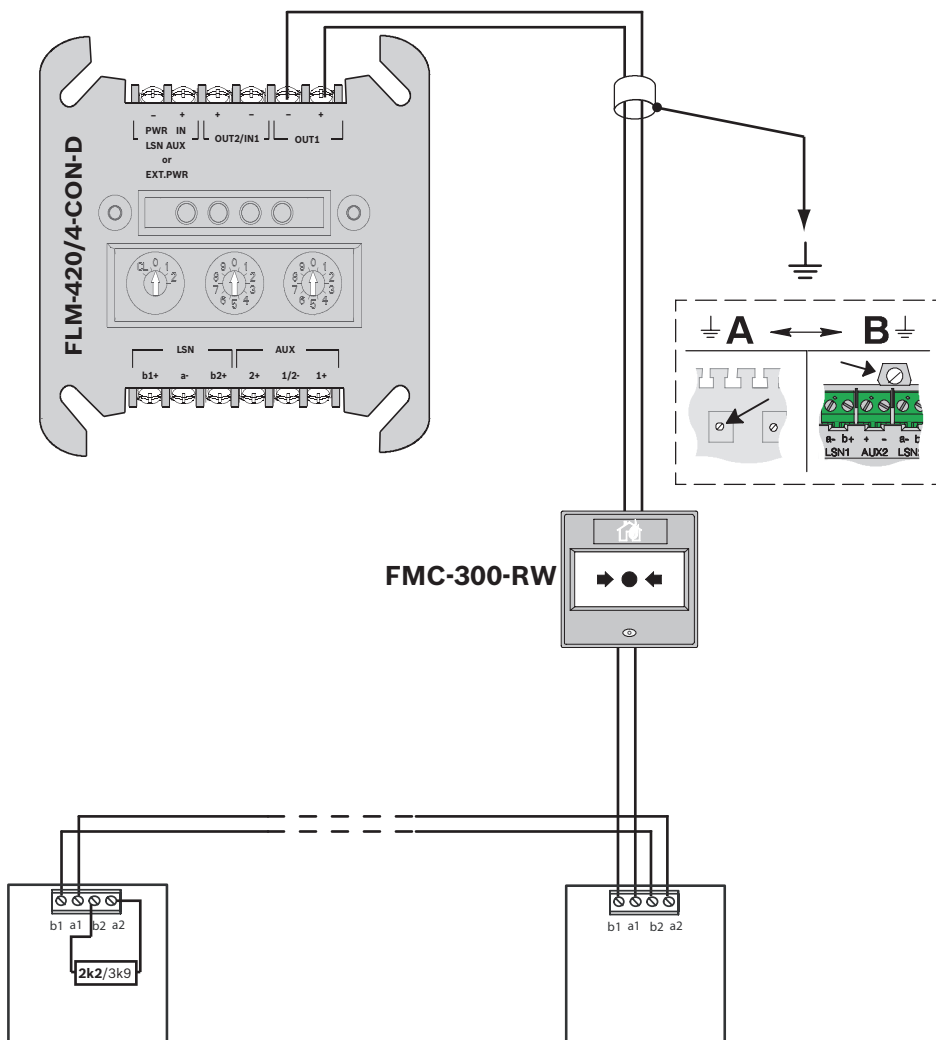
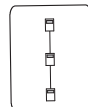



N4387A

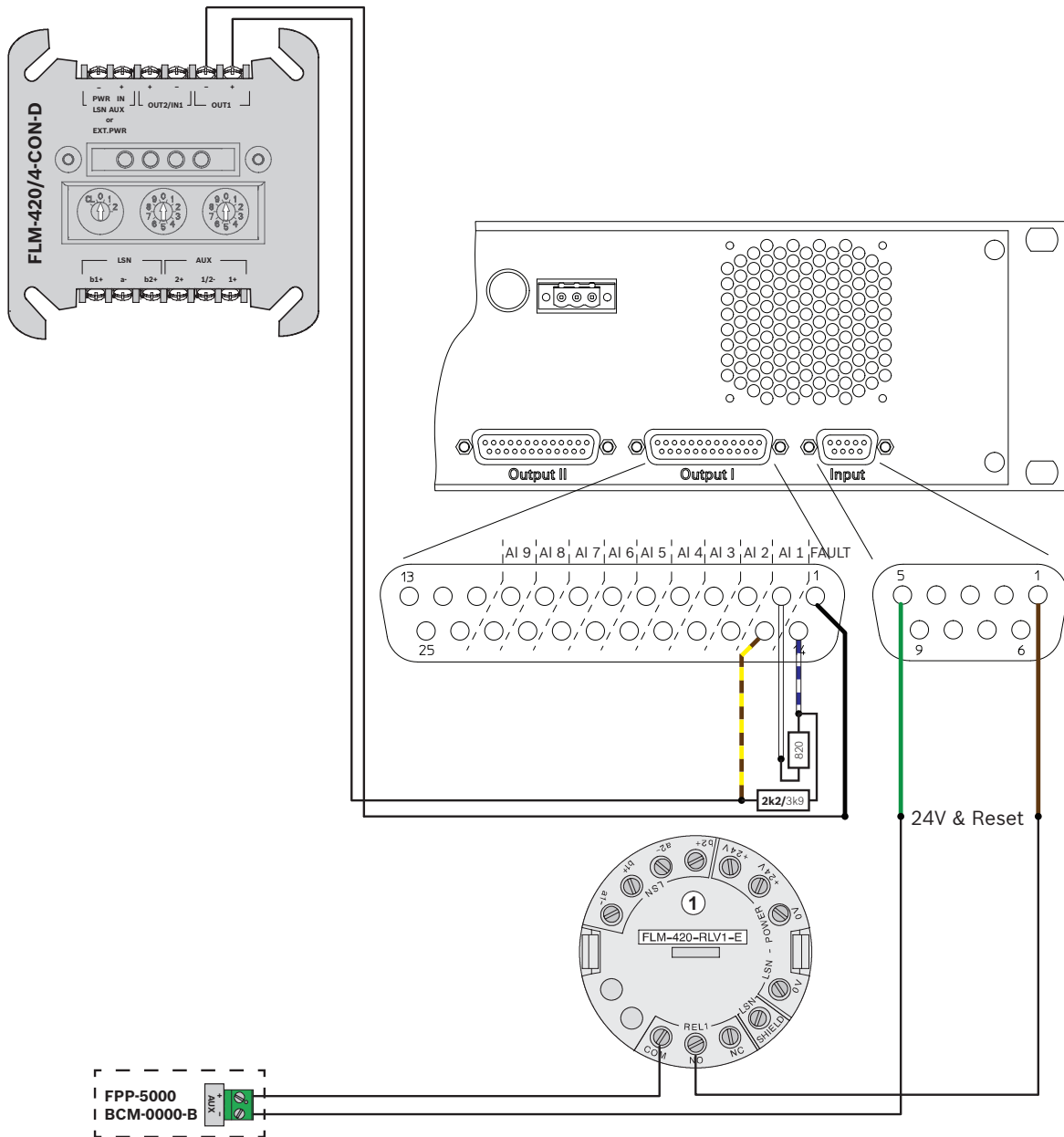

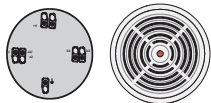

MSS 400, MSS 400 B  
 FCH-320-T320  
 FCH-T320-R470, FCH-T320-FSA  
 FCP-O320, FCP-O320-R470  
 FCP-OC320, FCP-OC320-R470  
 FCP-OT320, FCP-OT320-R470

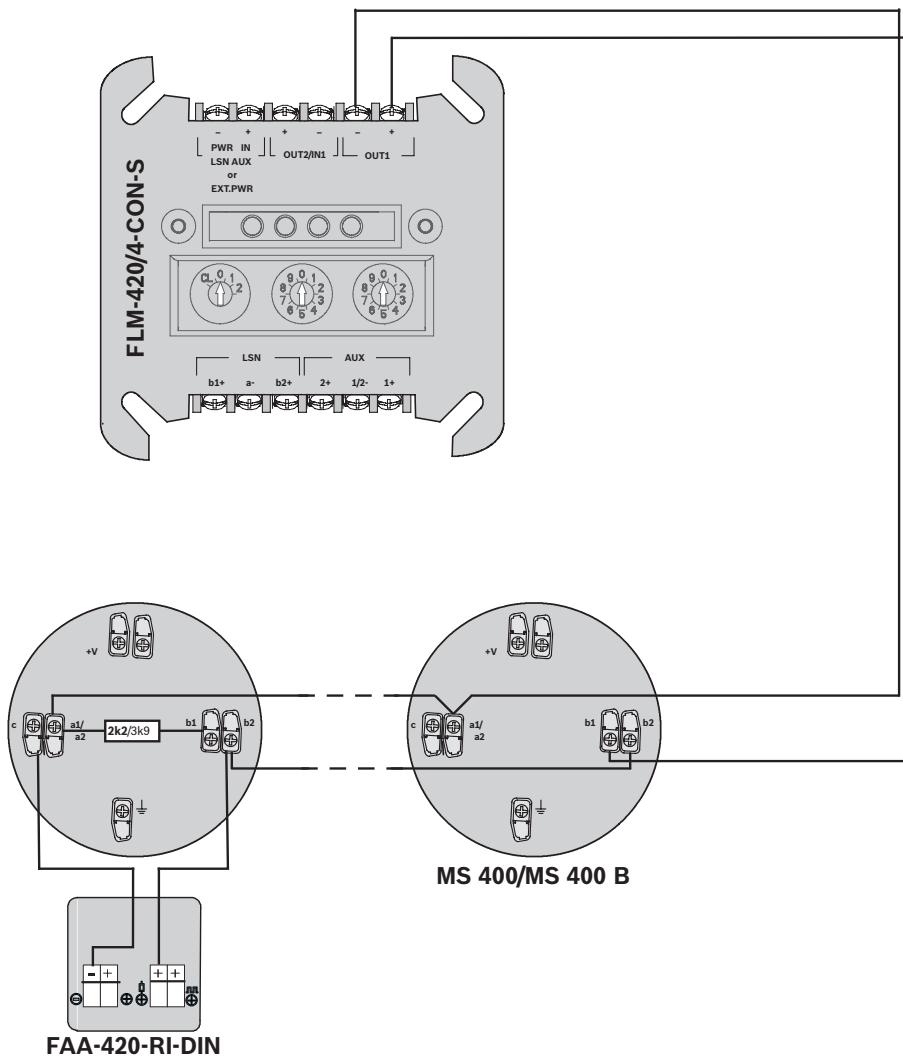



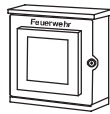
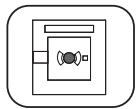

**2014/2 Ex**  
**2014/2 GLU-Ex**

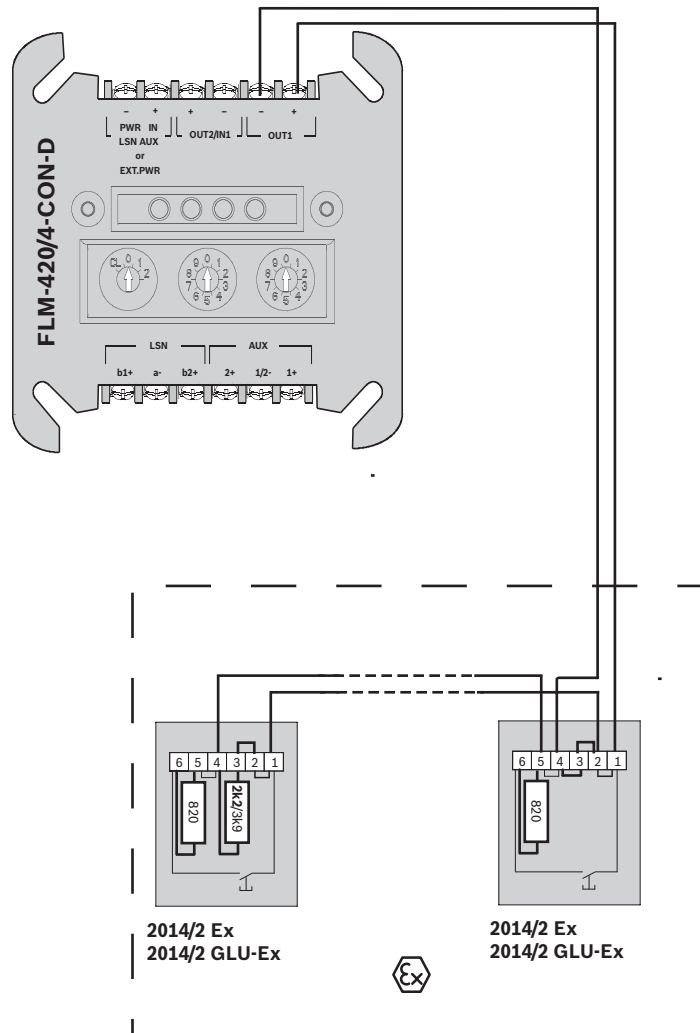
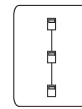

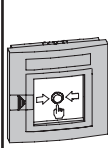
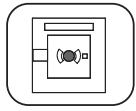

**FMC-120-DKM-G-R FMC-120-DKM-G-Y**  
**FMC-120-DKM-H-R FMC-120-EST-G-B**  
**FMC-120-DKM-G-B**  
**FMC-120-DKM-H-B**

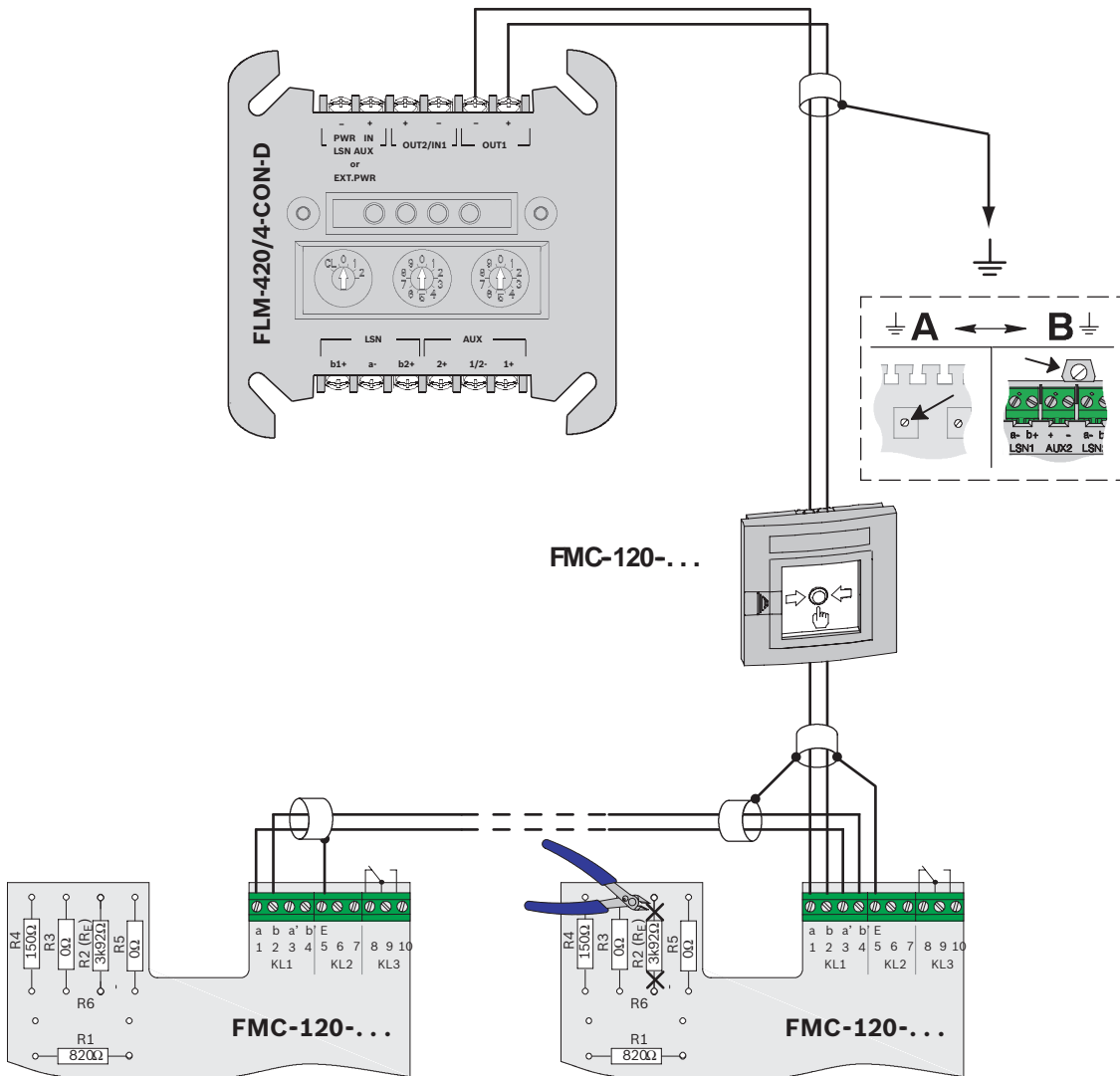
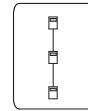

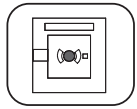

NO

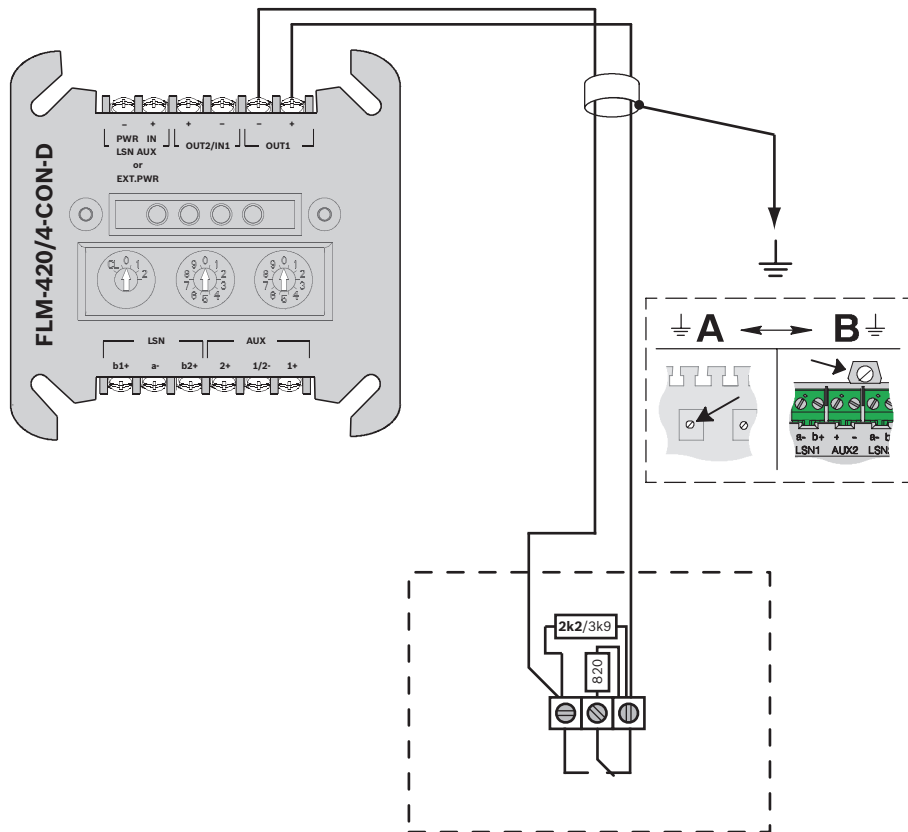
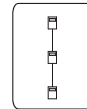

2.5.2

FLM-420-I8R1-S

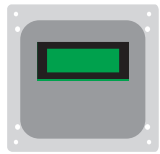

ProReact EN Analogue

FCS-LHD-2EN

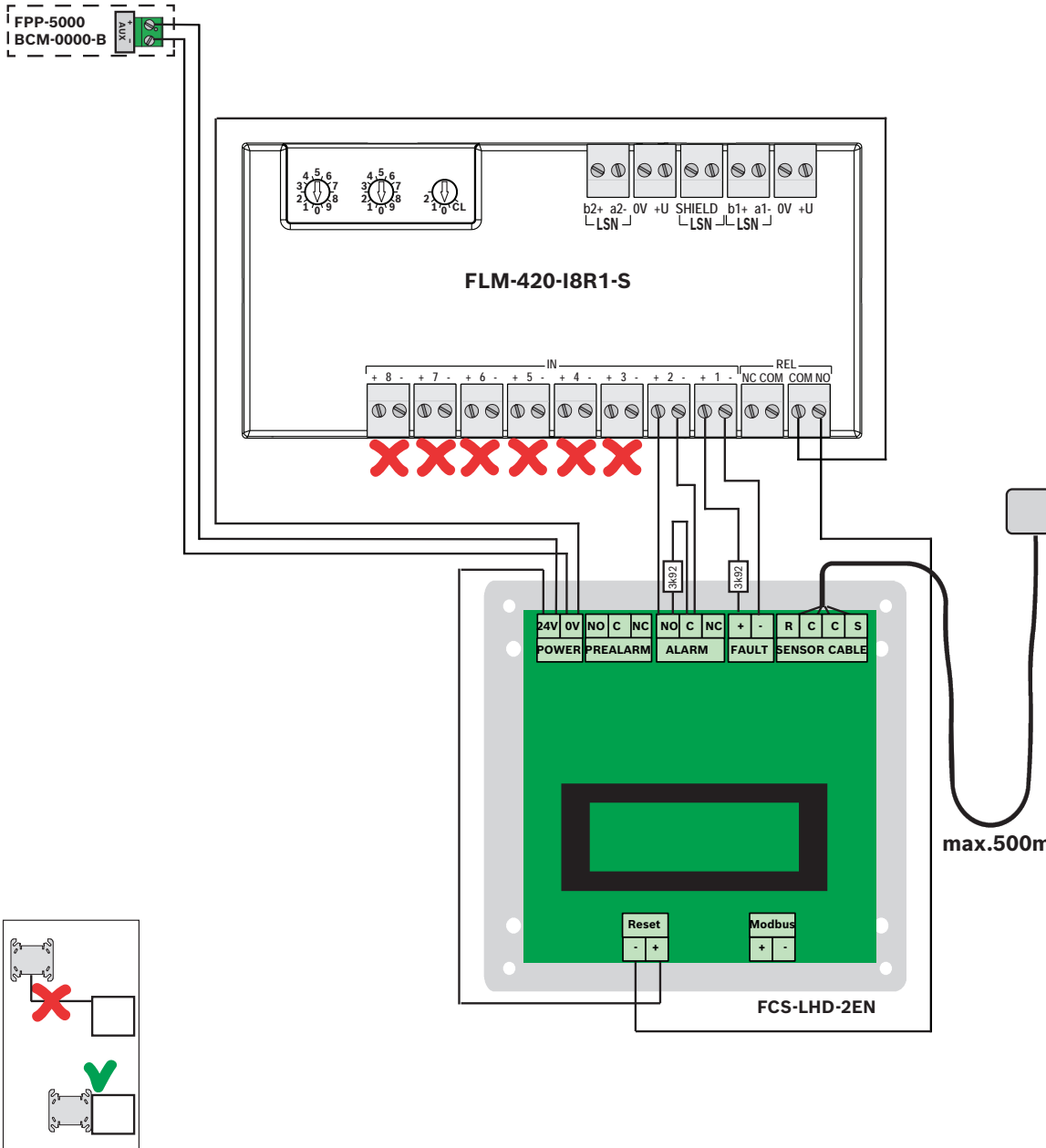

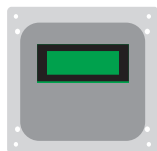

ProReact EN Analogue

FCS-LHD-2EN



ELS

FPP-3000(ZSP135-DR)  
FPP-5000  
BCM-0000-B

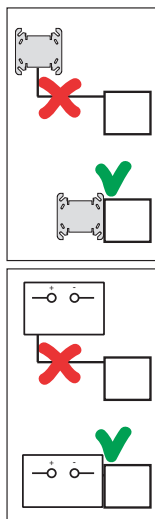
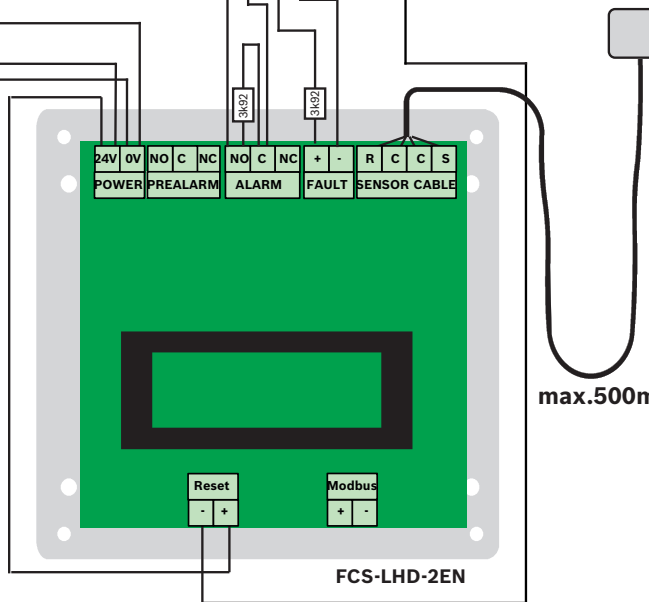
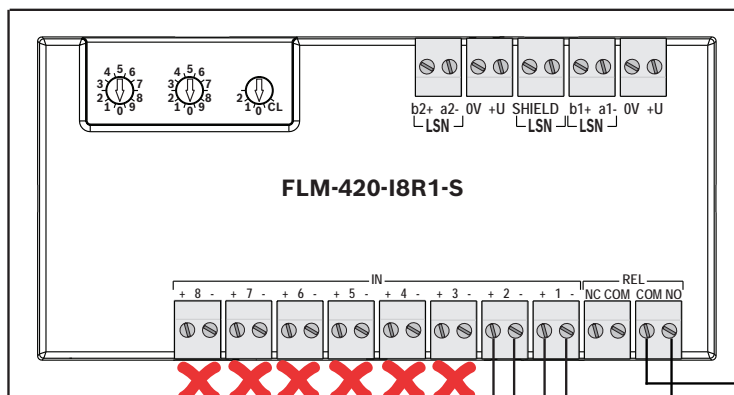

### 2.5.3 FLM-420-NAC-D/S

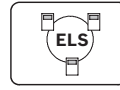

FPP-3000(ZSP135-DR)  
FPP-5000  
BCM-0000-B

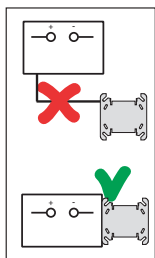
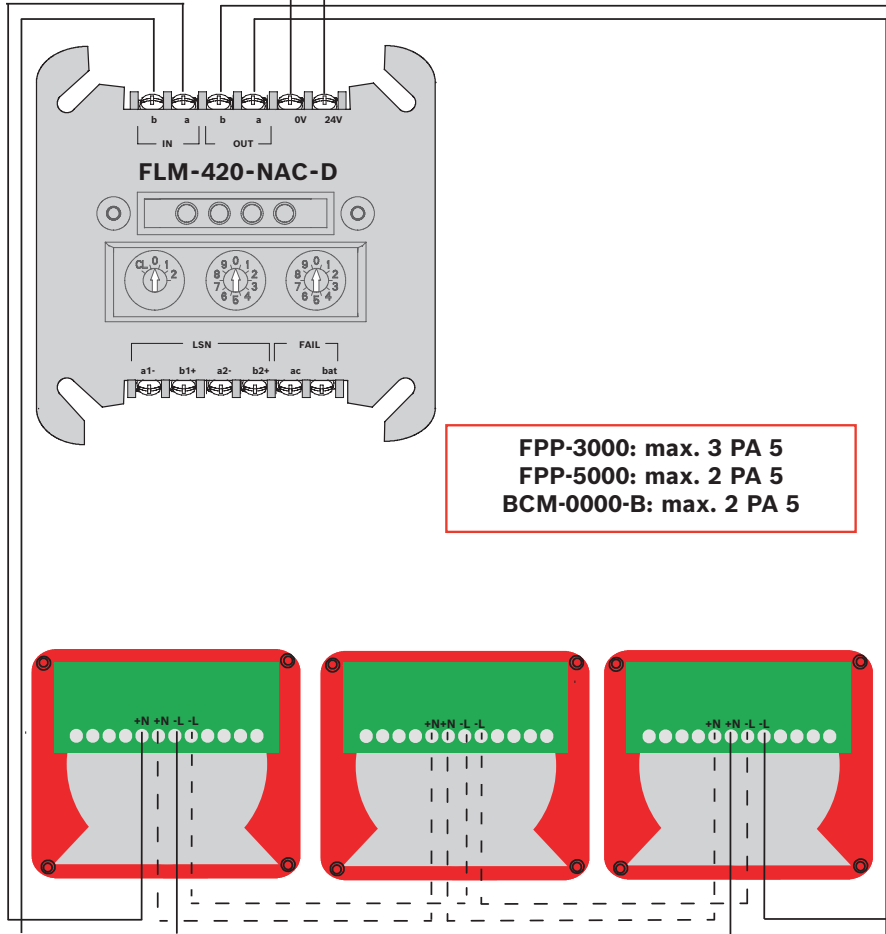



FPP-3000  
FPP-5000  
BCM-0000-B

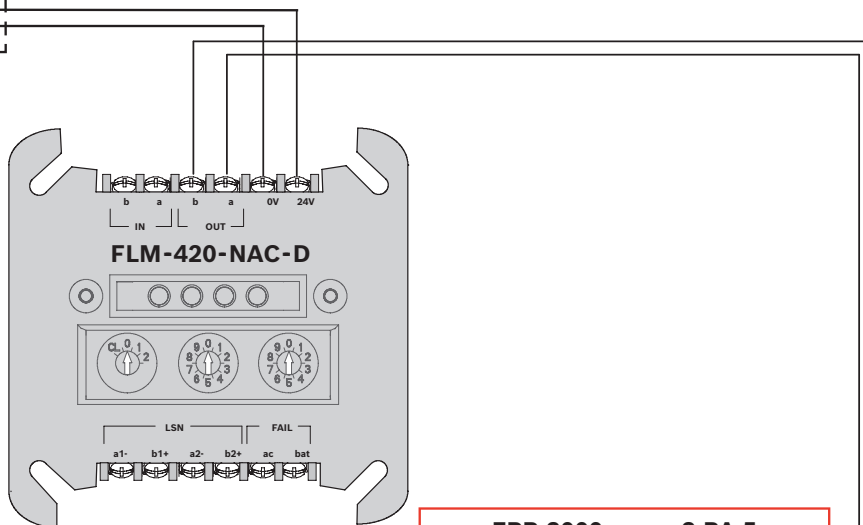

**FPP-3000: max. 3 PA 5**  
**FPP-5000: max. 2 PA 5**  
**BCM-0000-B: max. 2 PA 5**

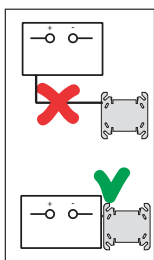
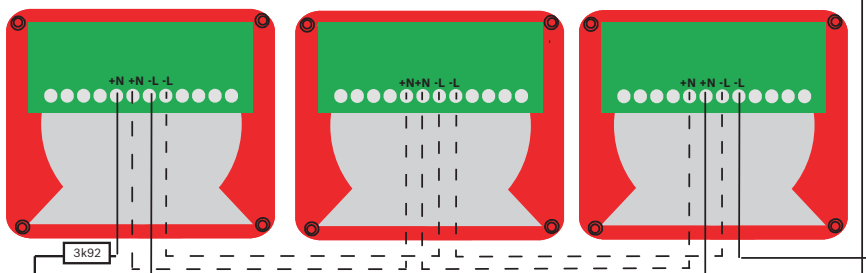

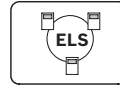

FPP-3000(ZSP135-DR)  
 FPP-5000  
 BCM-0000-B

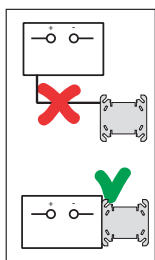
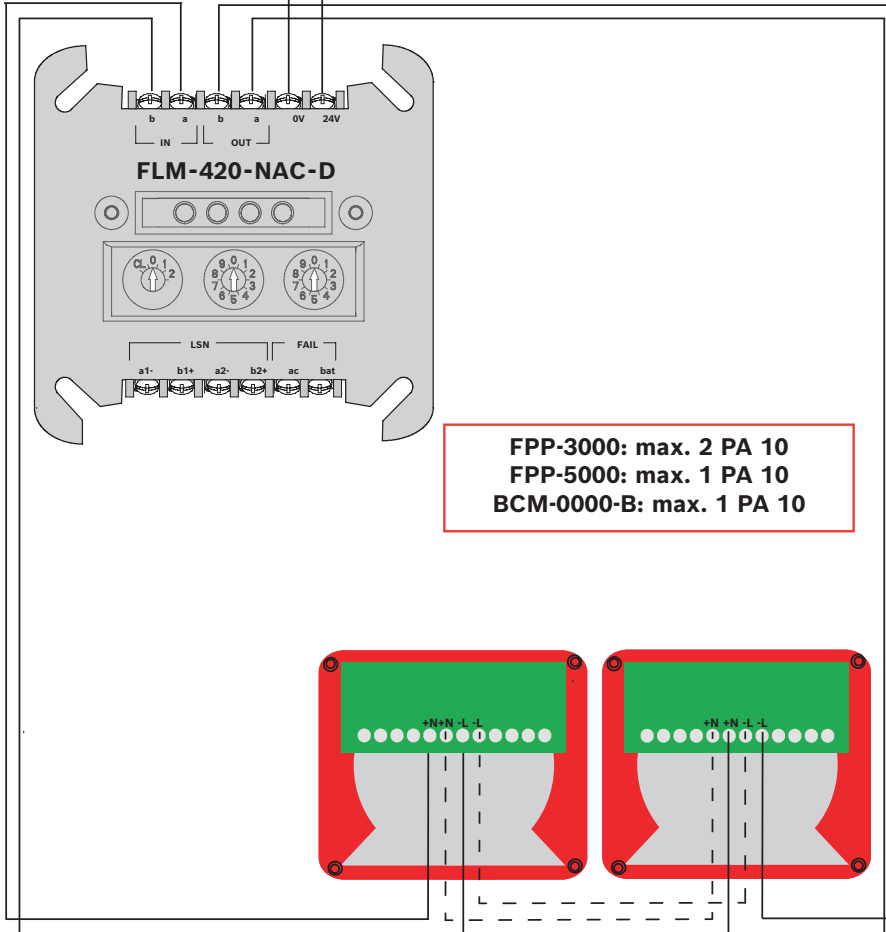





FPP-3000  
FPP-5000  
BCM-0000-B

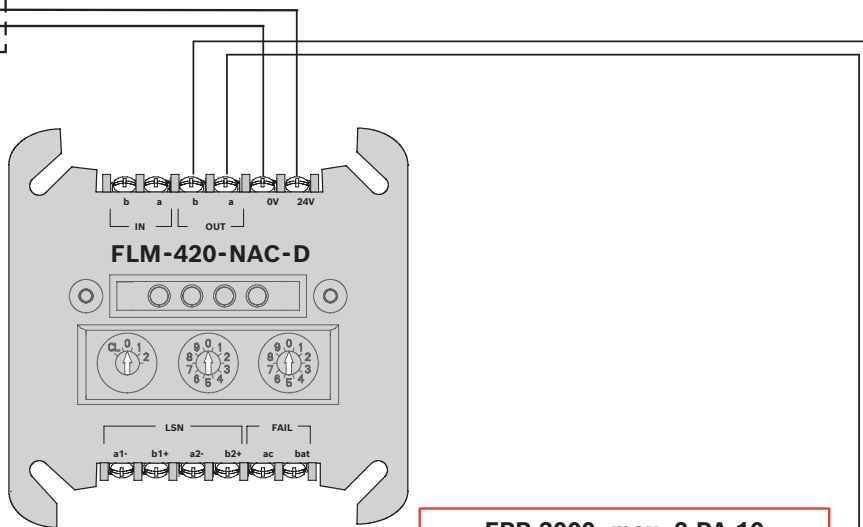

**FPP-3000: max. 2 PA 10**  
**FPP-5000: max. 1 PA 10**  
**BCM-0000-B: max. 1 PA 10**

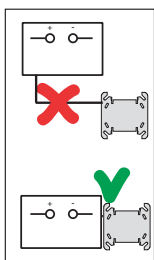
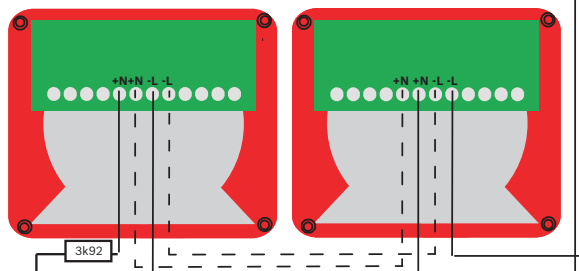

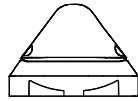

**PY X-M-10-SSM R**  
**PY X-M-10-SSM W**

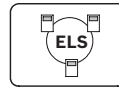

FPP-3000(ZSP-135-DR)  
 FPP-5000  
 BCM-0000-B

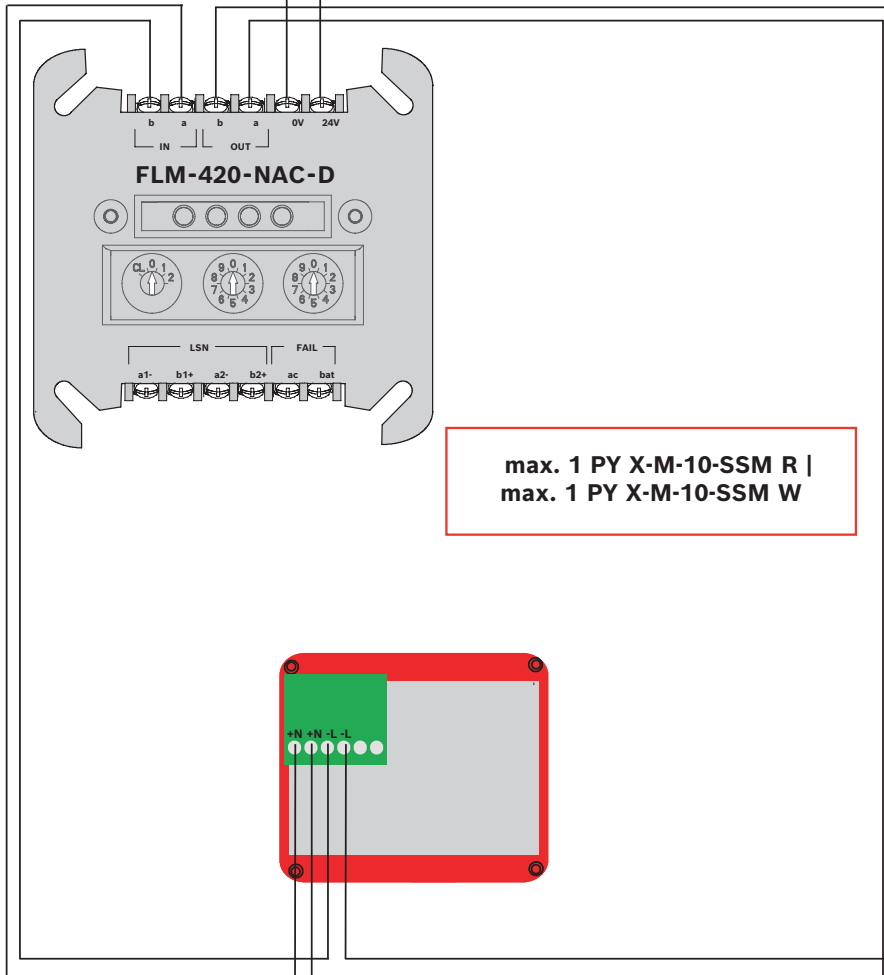

**max. 1 PY X-M-10-SSM R |**  
**max. 1 PY X-M-10-SSM W**

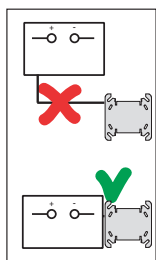

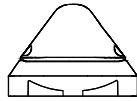

**PY X-M-10-SSM R**  
**PY X-M-10-SSM W**



FPP-3000  
 FPP-5000  
 BCM-0000-B

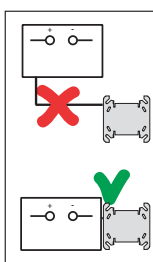
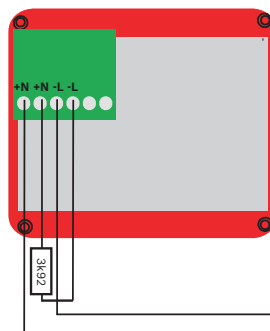
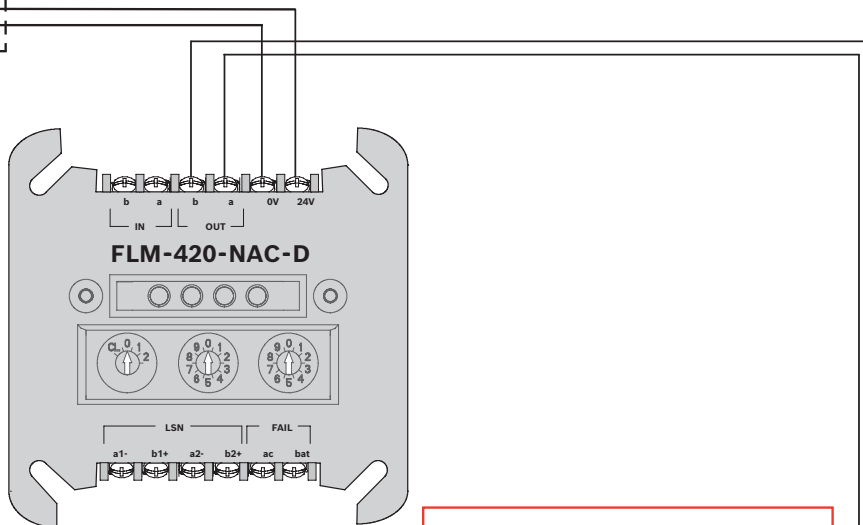



PB 2005

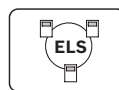

FPP-5000  
BCM-0000-B

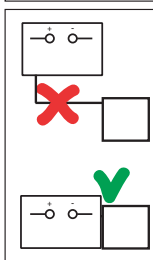
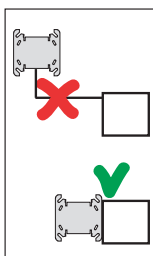
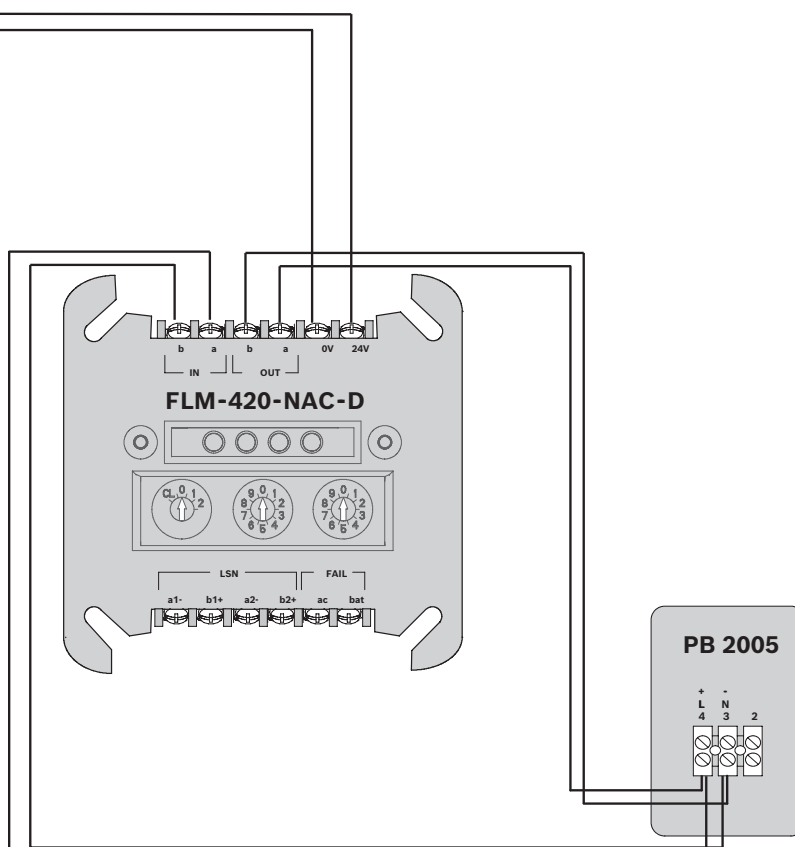



PB 2005

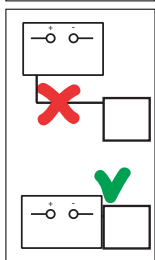
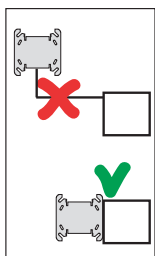
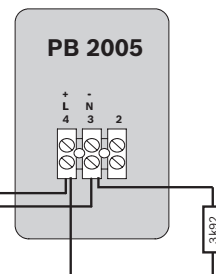
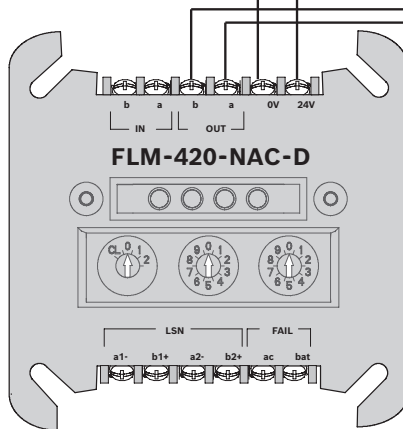

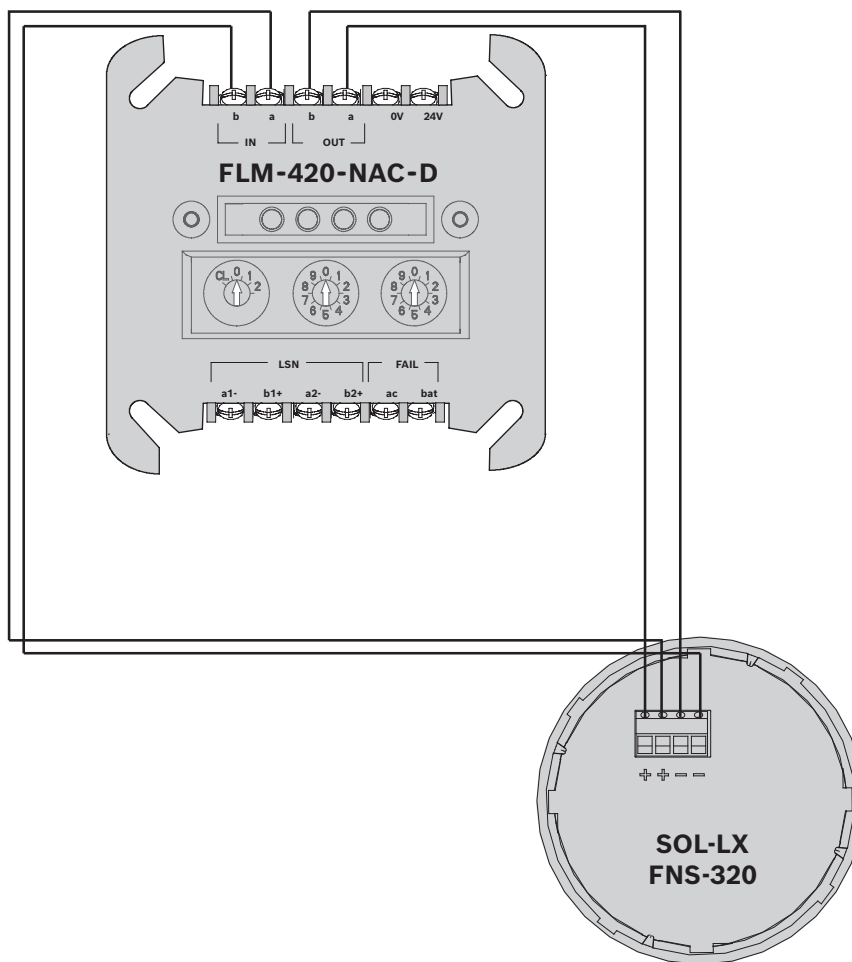
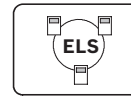

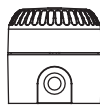

**SOL-LX  
FNS-320**

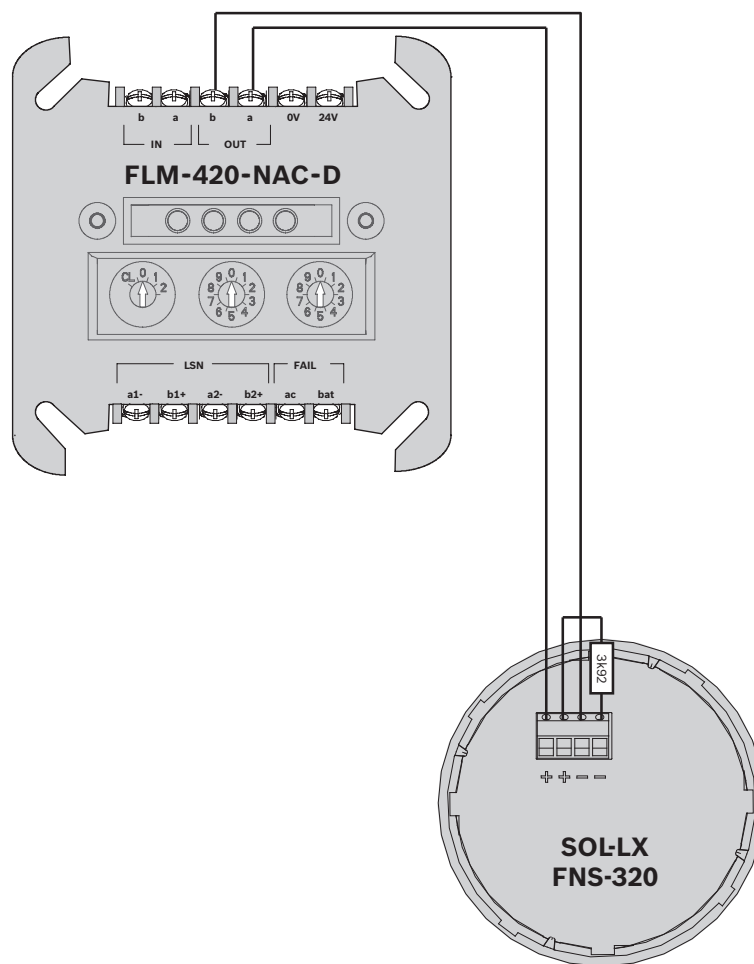
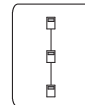

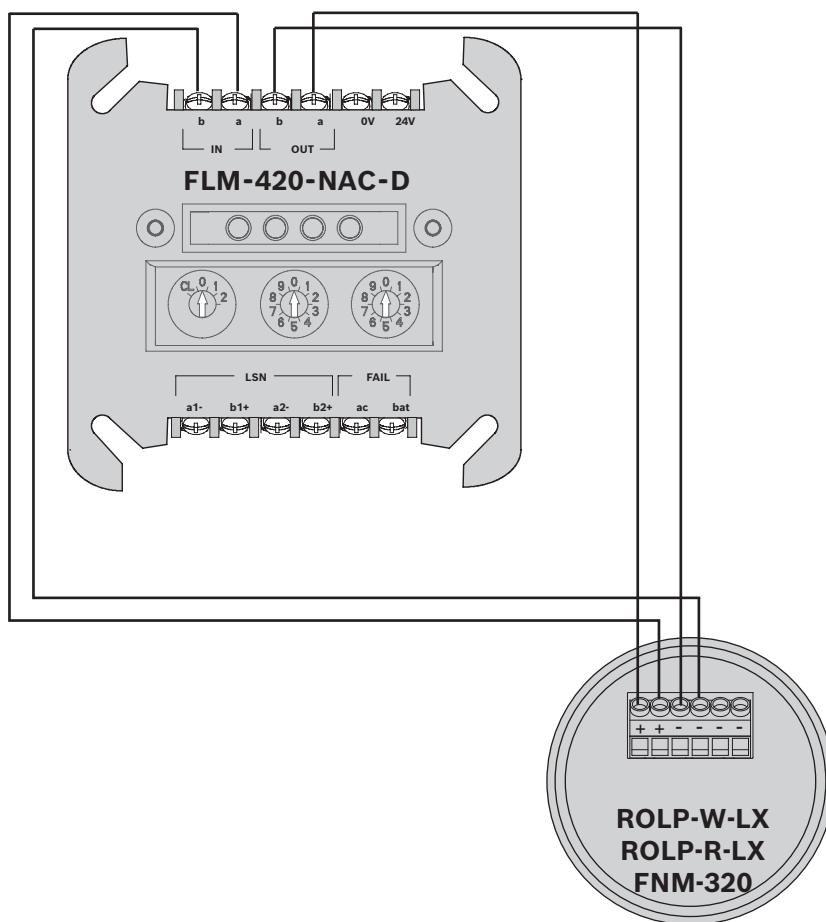
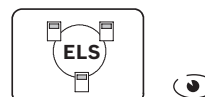



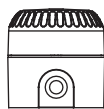
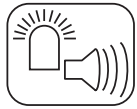

**ROLP-W-LX**  
**ROLP-R-LX**  
**FNM-320**

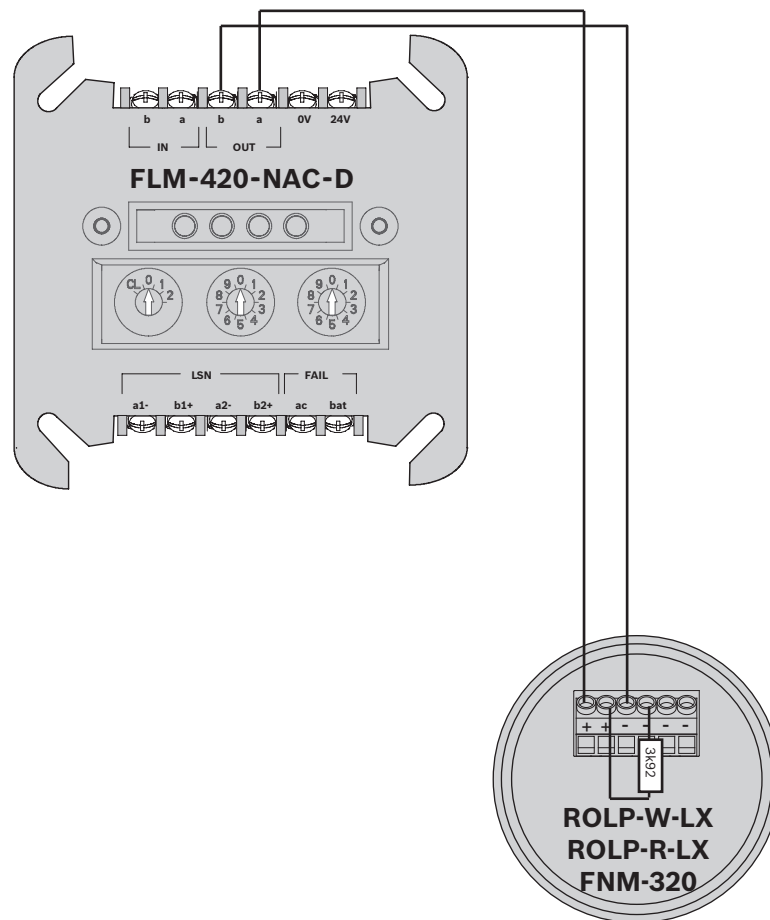
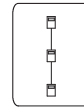

### 2.5.4 FLM-420-RHV

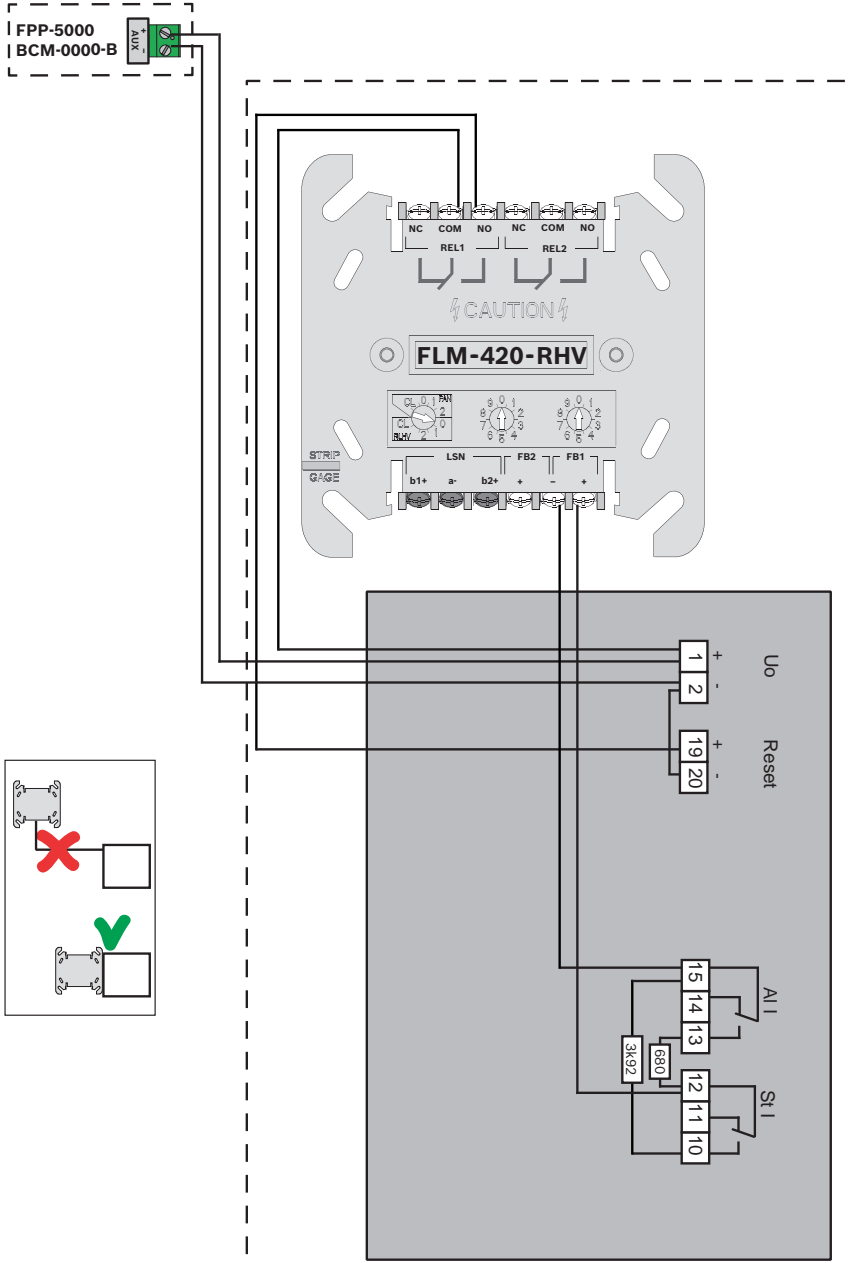
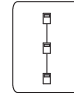



ELS

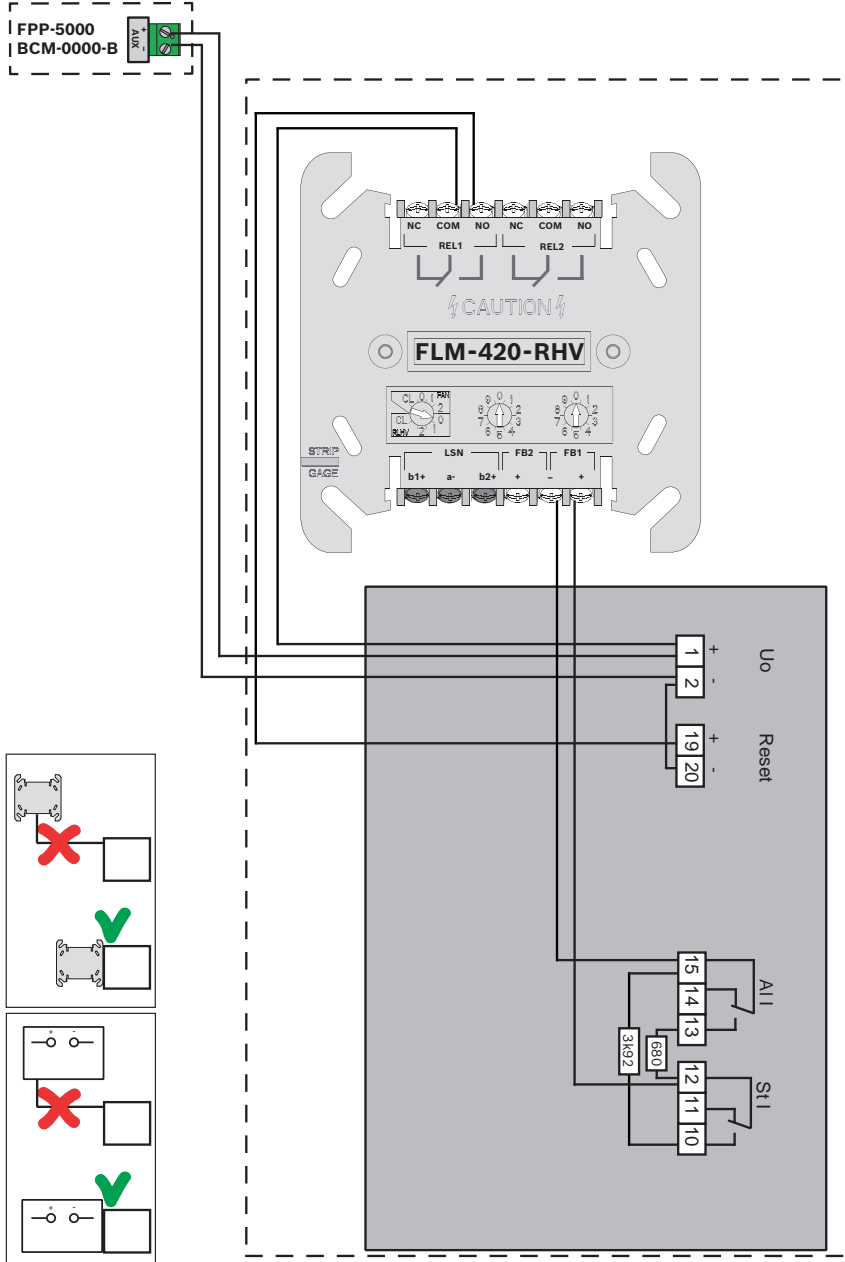

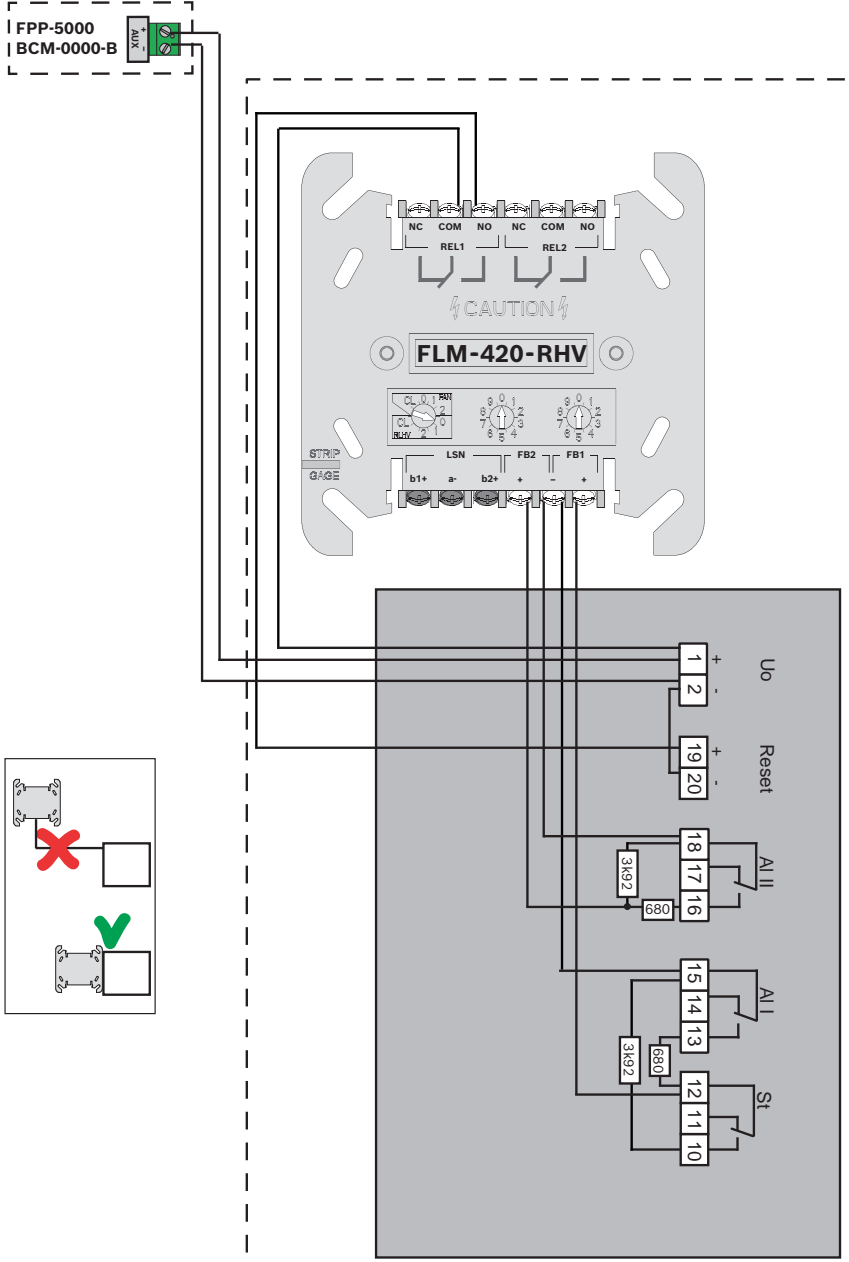
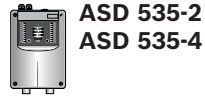



ELS

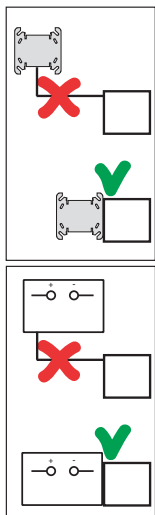
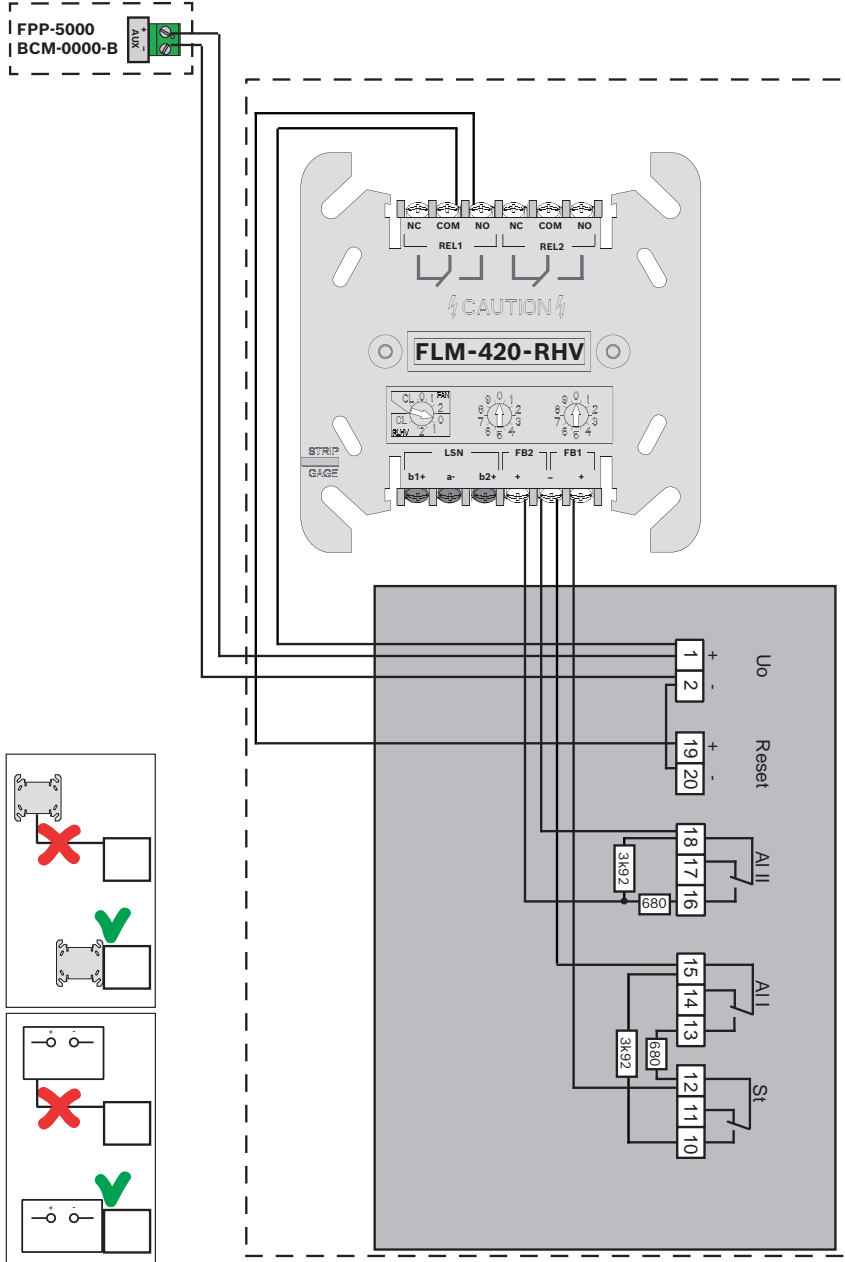

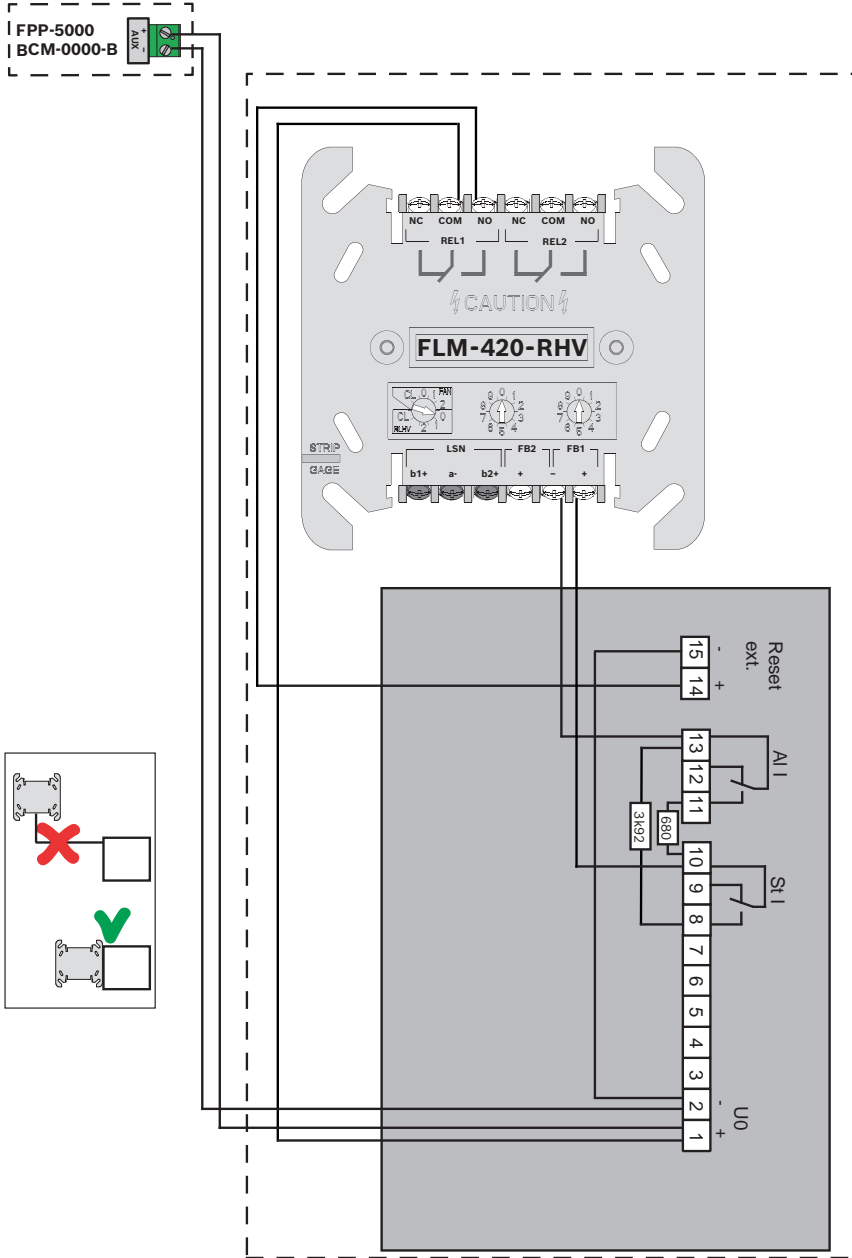



ELS

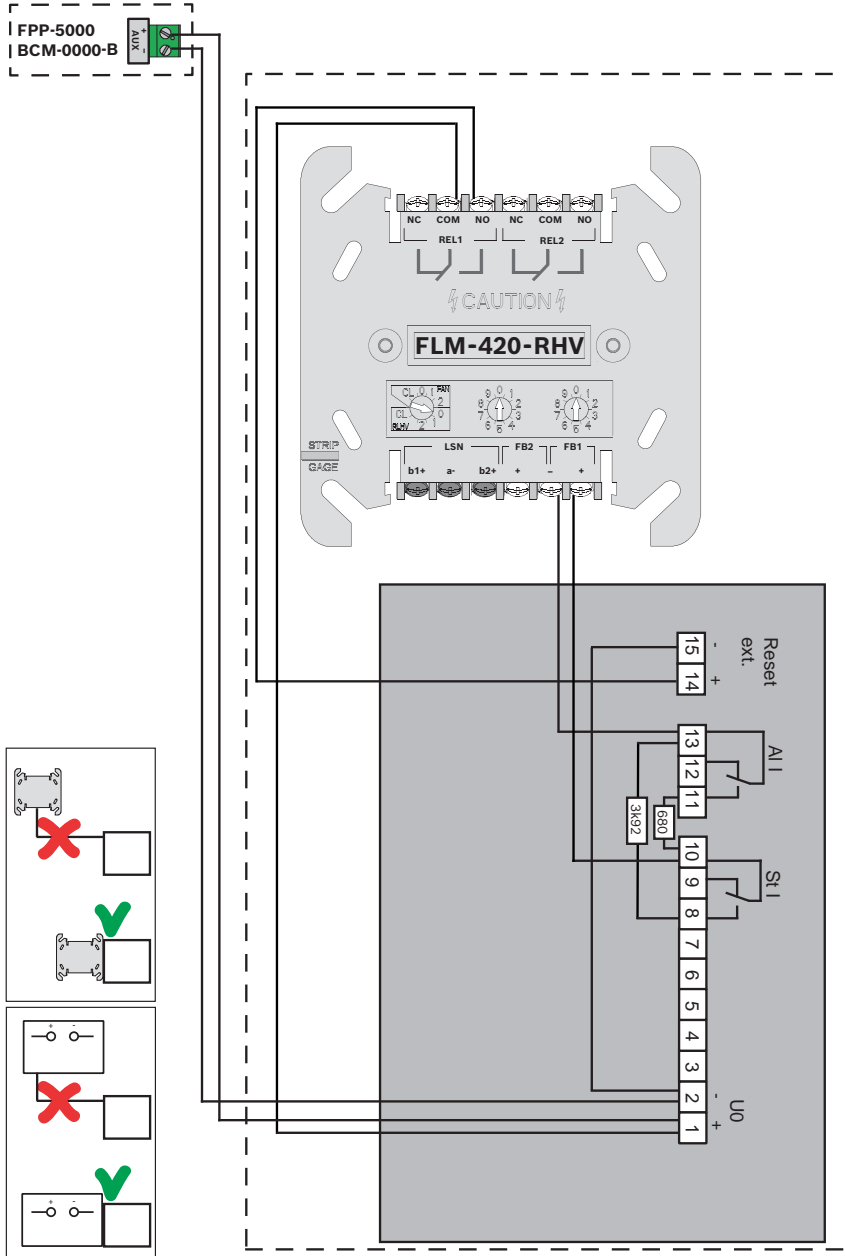



ADW 535-1

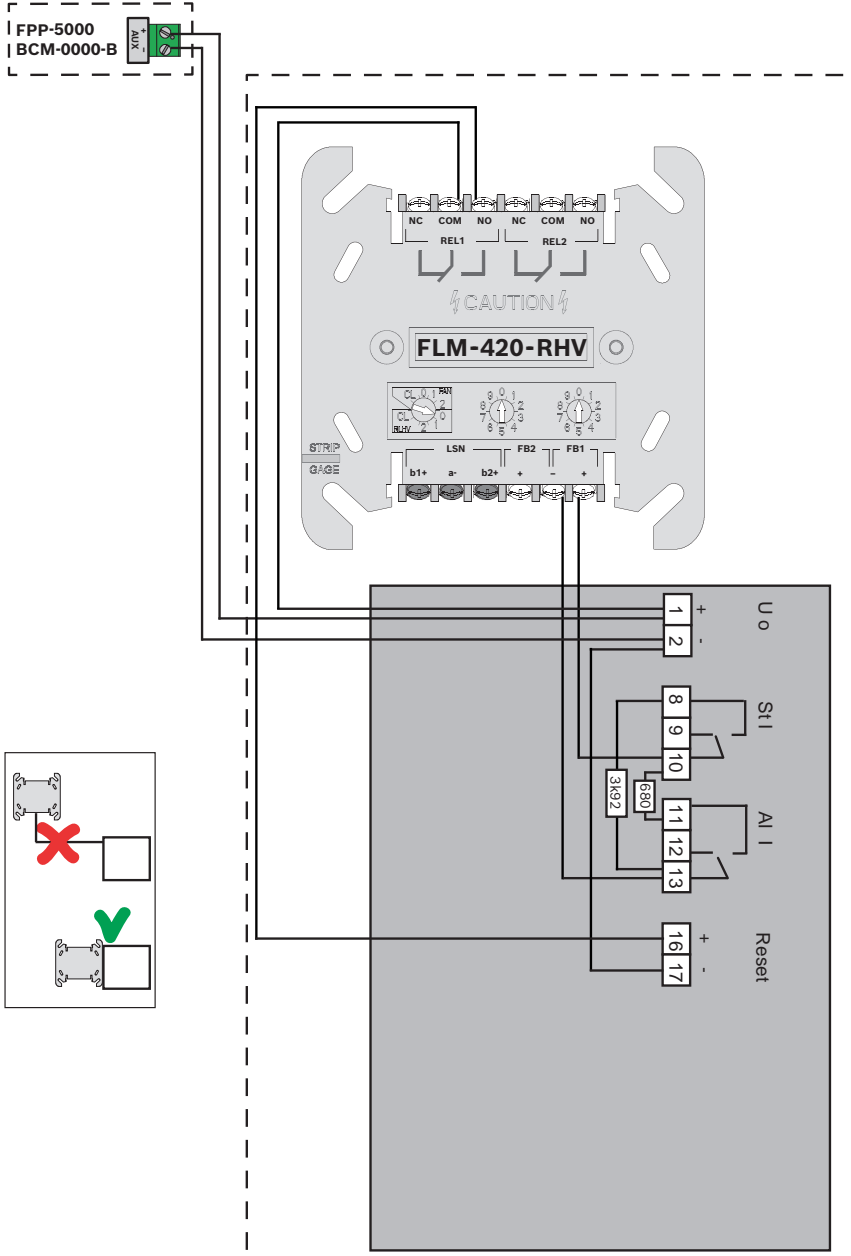





ADW 535-1



ELS

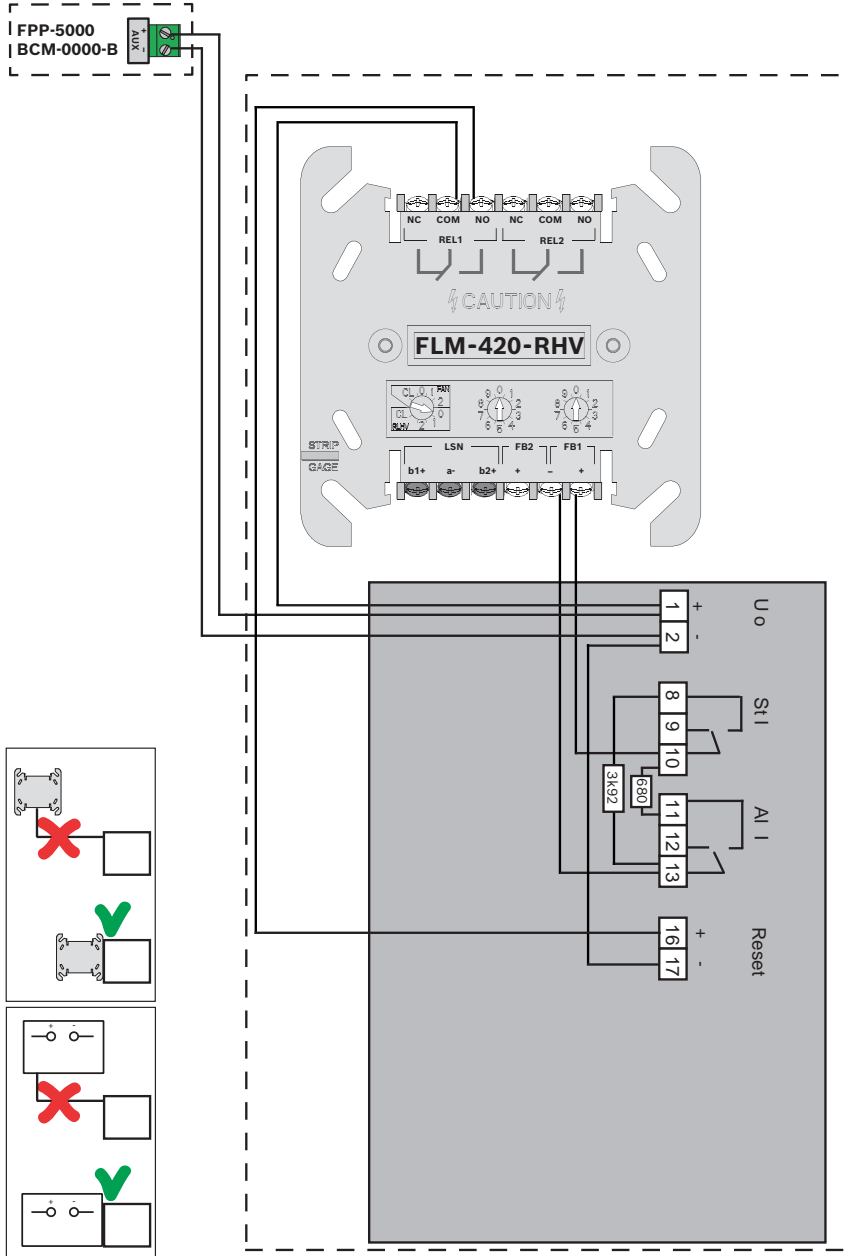



ADW 535-2

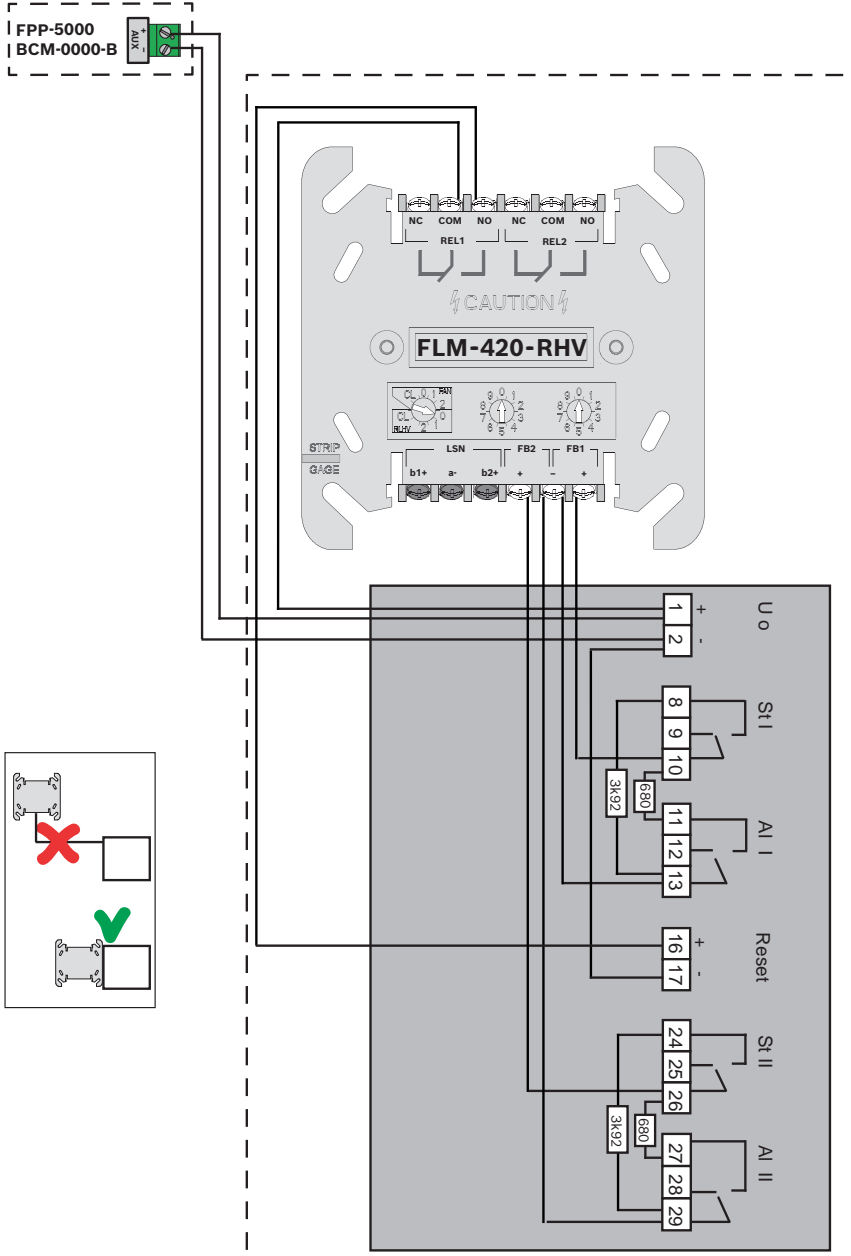



**ADW 535-2**



**ELS**

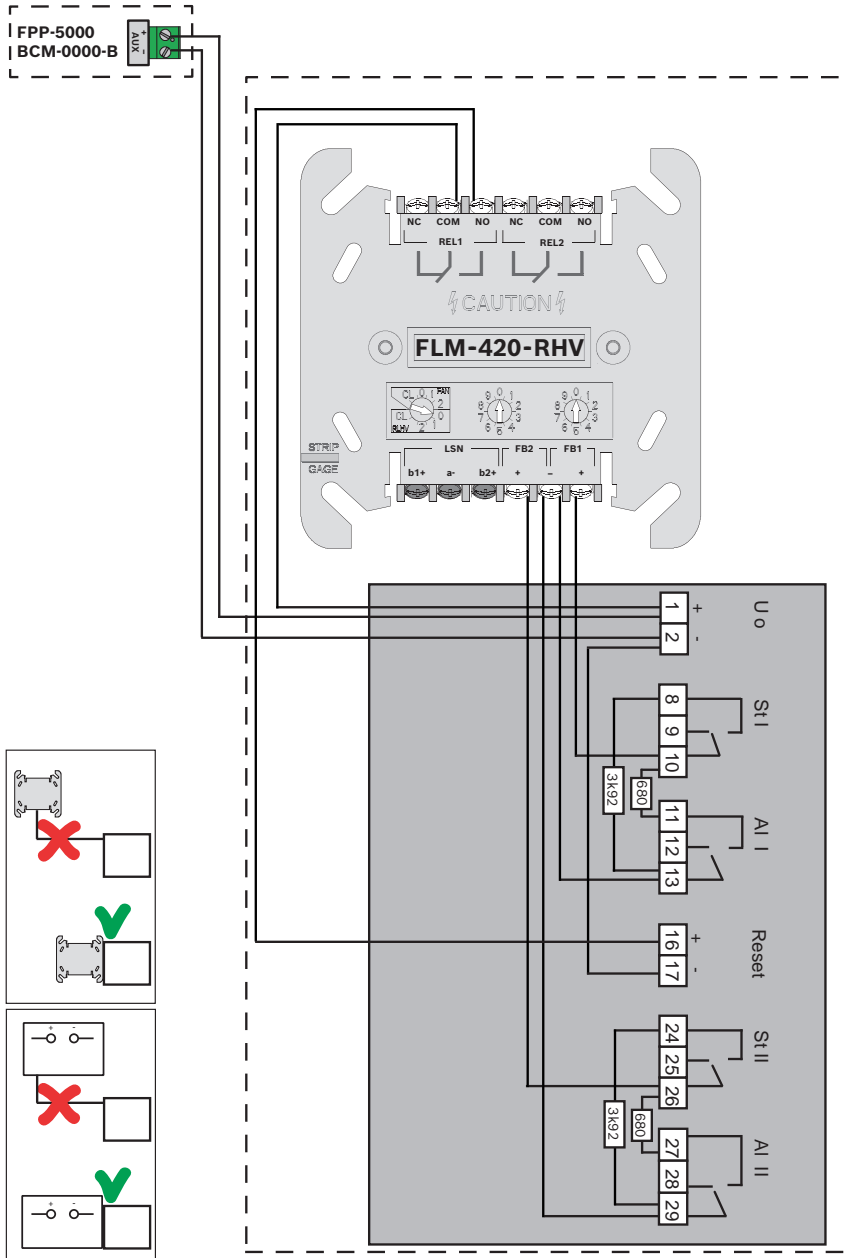



**Fireray One**

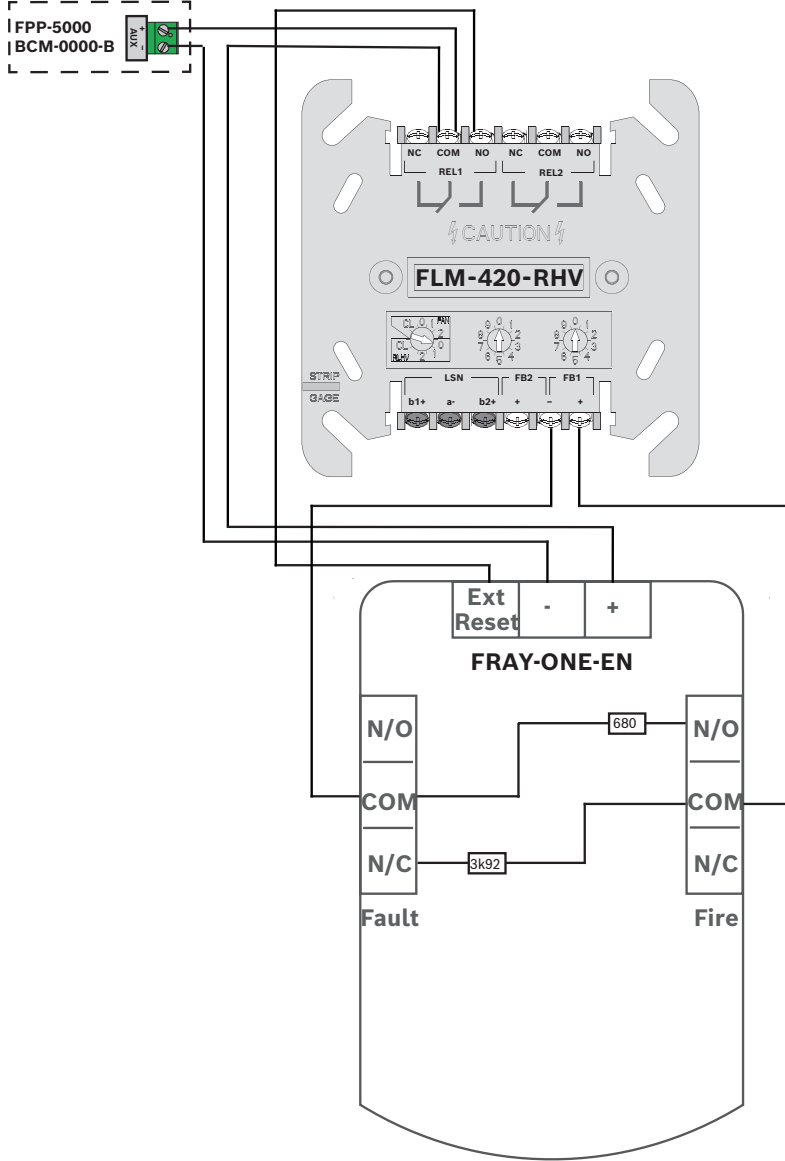



**Fireray One**



**ELS**

FPP-5000  
BCM-0000-B

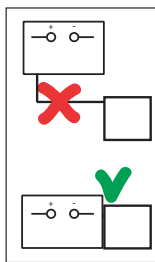
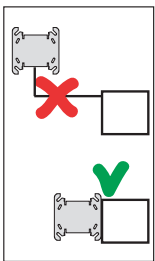
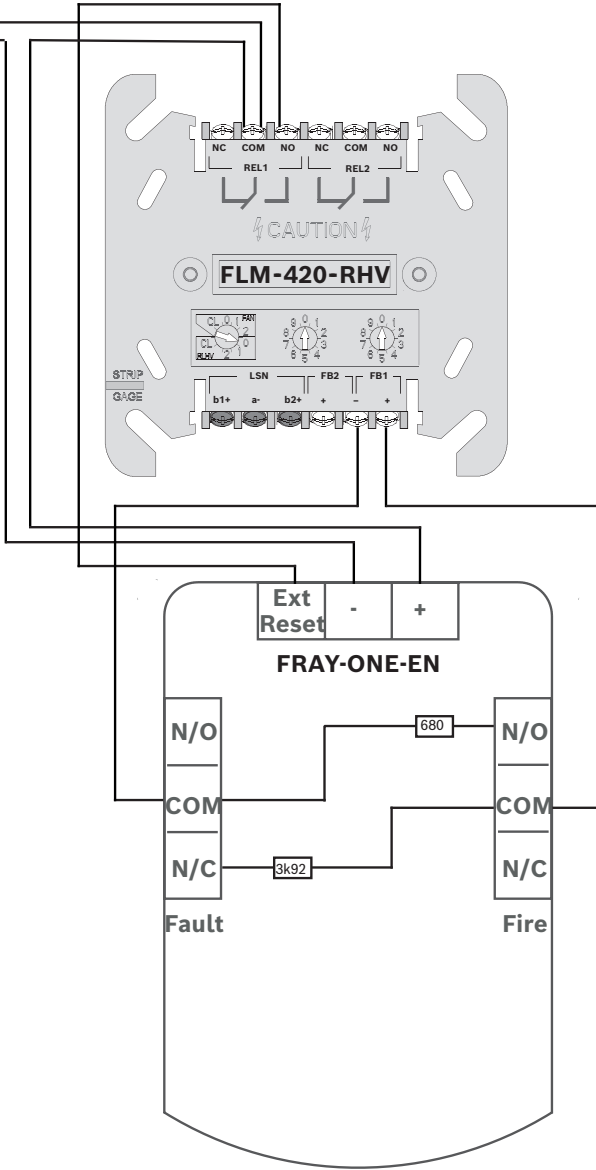

2.5.5

FLM-420-RLE-S



VdS 2496

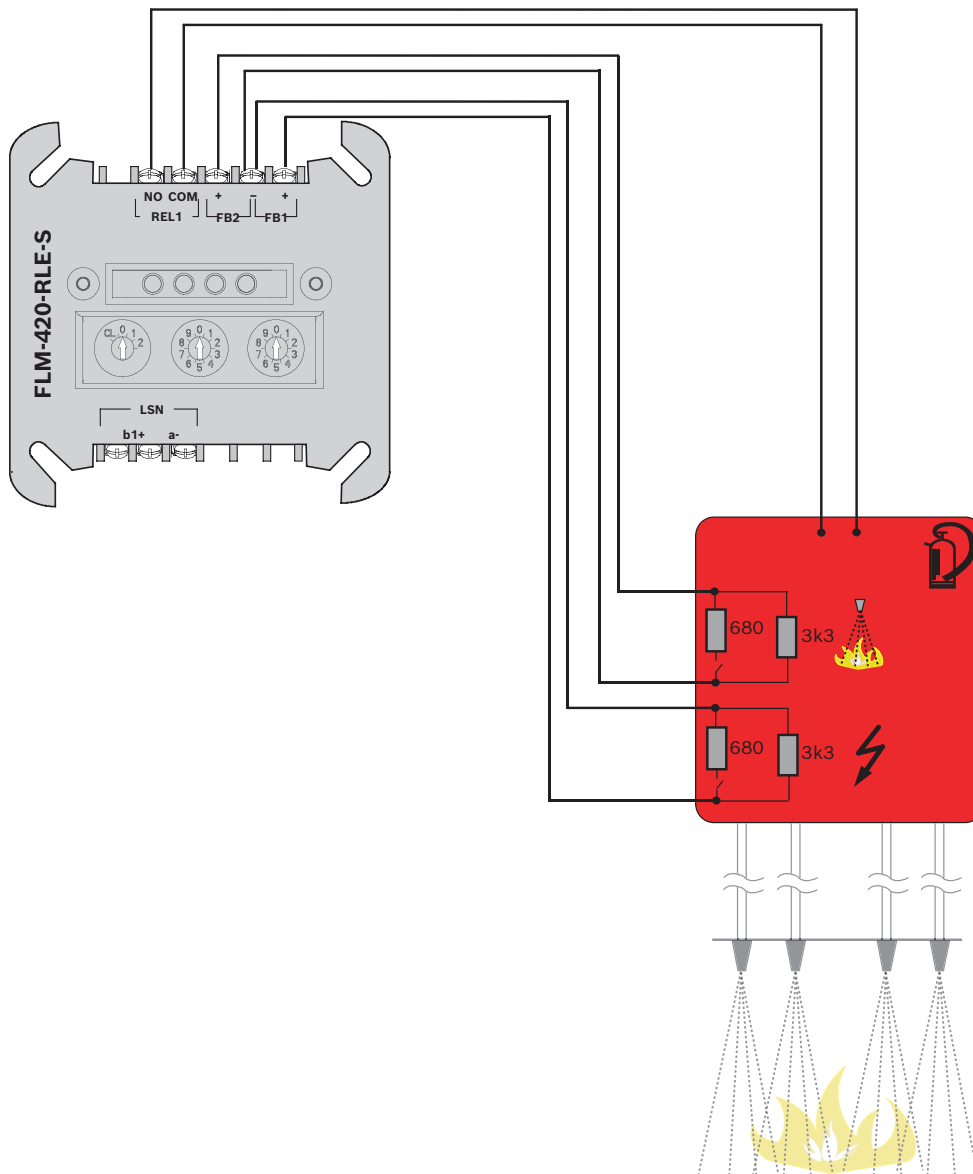

### 2.5.6 FLM-420-RLV1-E

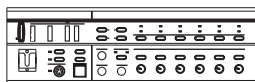
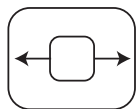

Plena

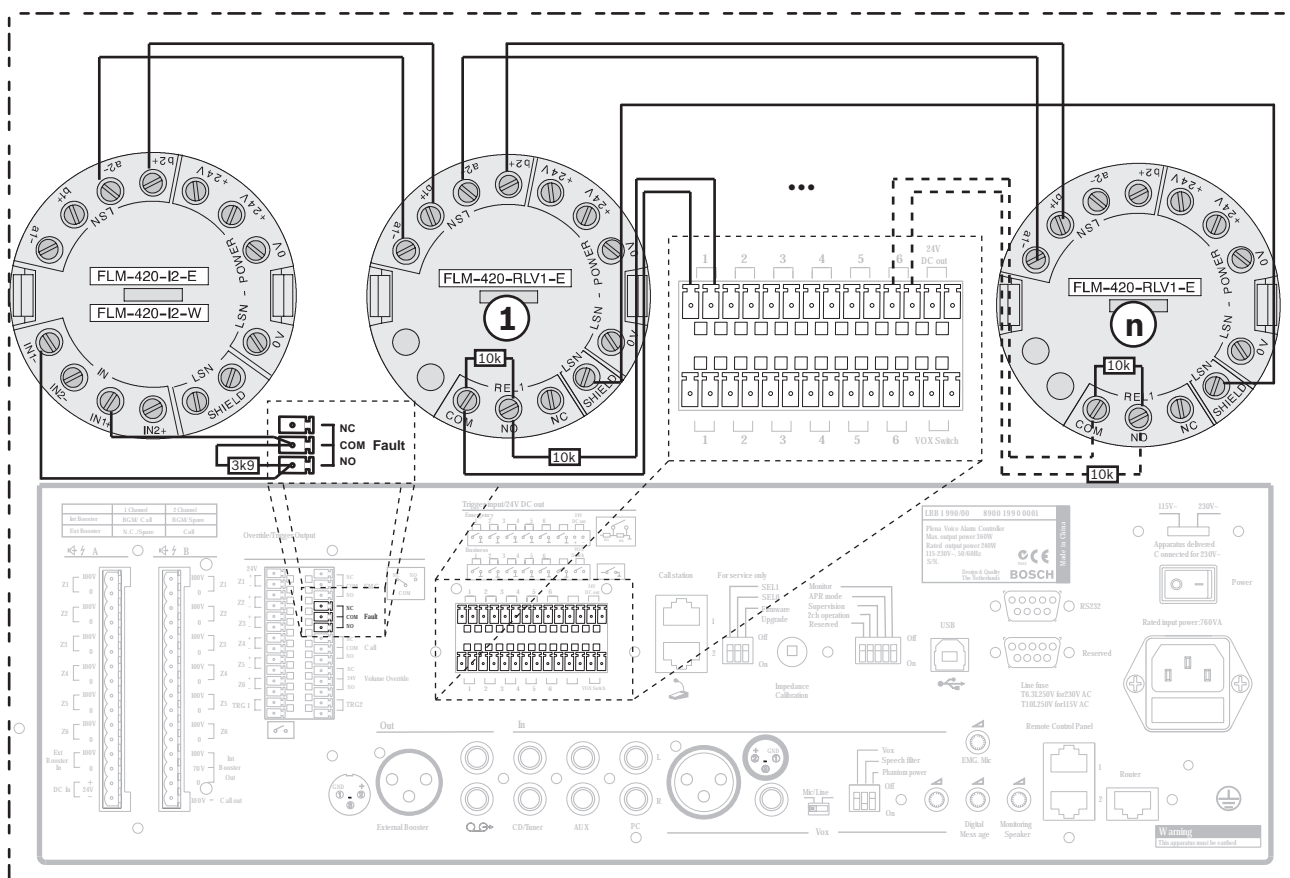

### 2.5.7 FLM-420-RLV8-S

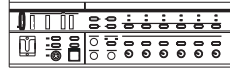
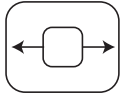

Plena

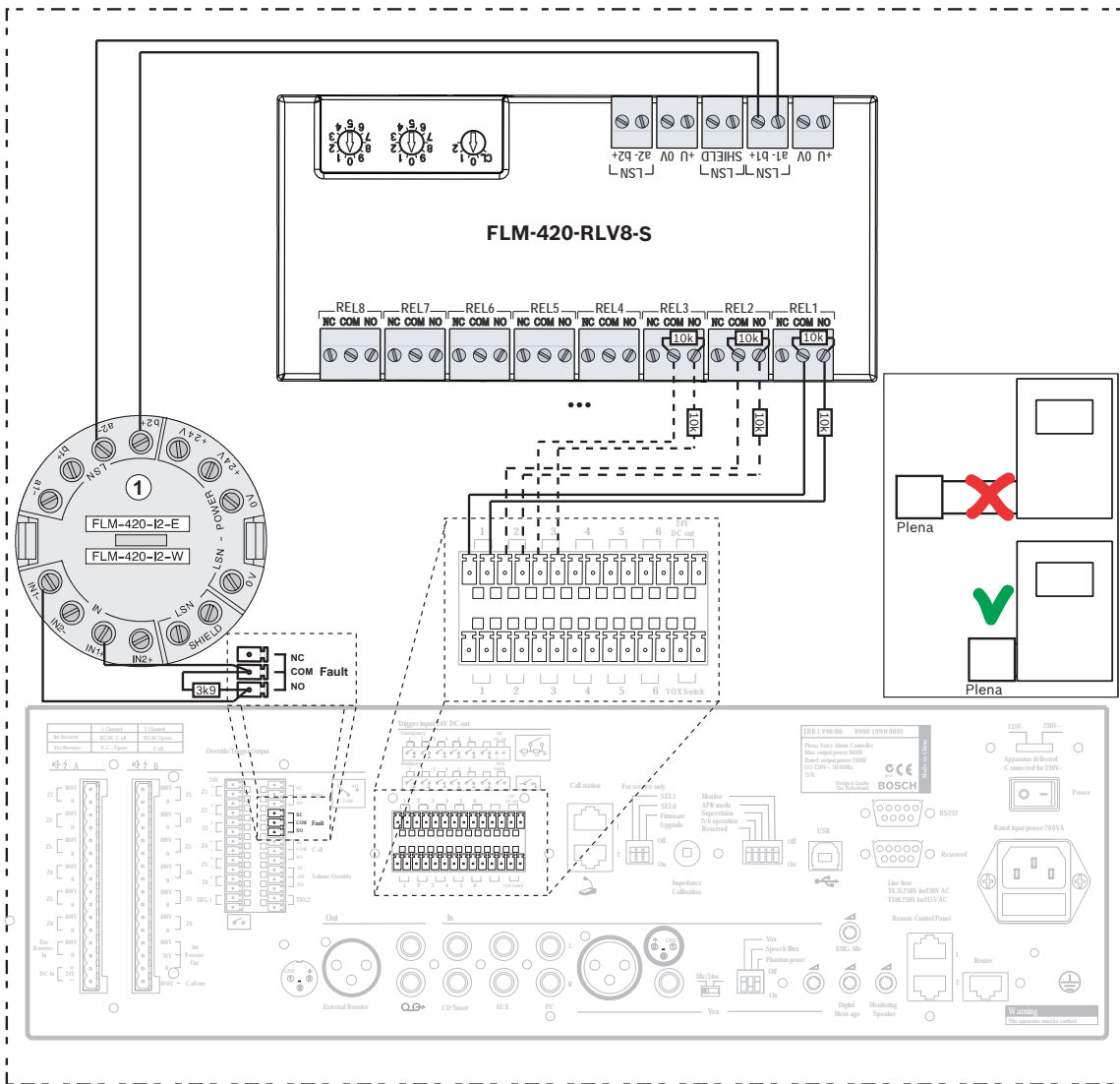
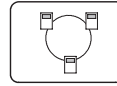



### 2.5.8 FMF-ADP-FBF/FMF-ADP-TTY



FAT4000 FBF4000 ADP4000

FMF-FAT FMF-FBF-FAT  
FMF-FIBS-A4/-A3  
FMF-ADP

ELS

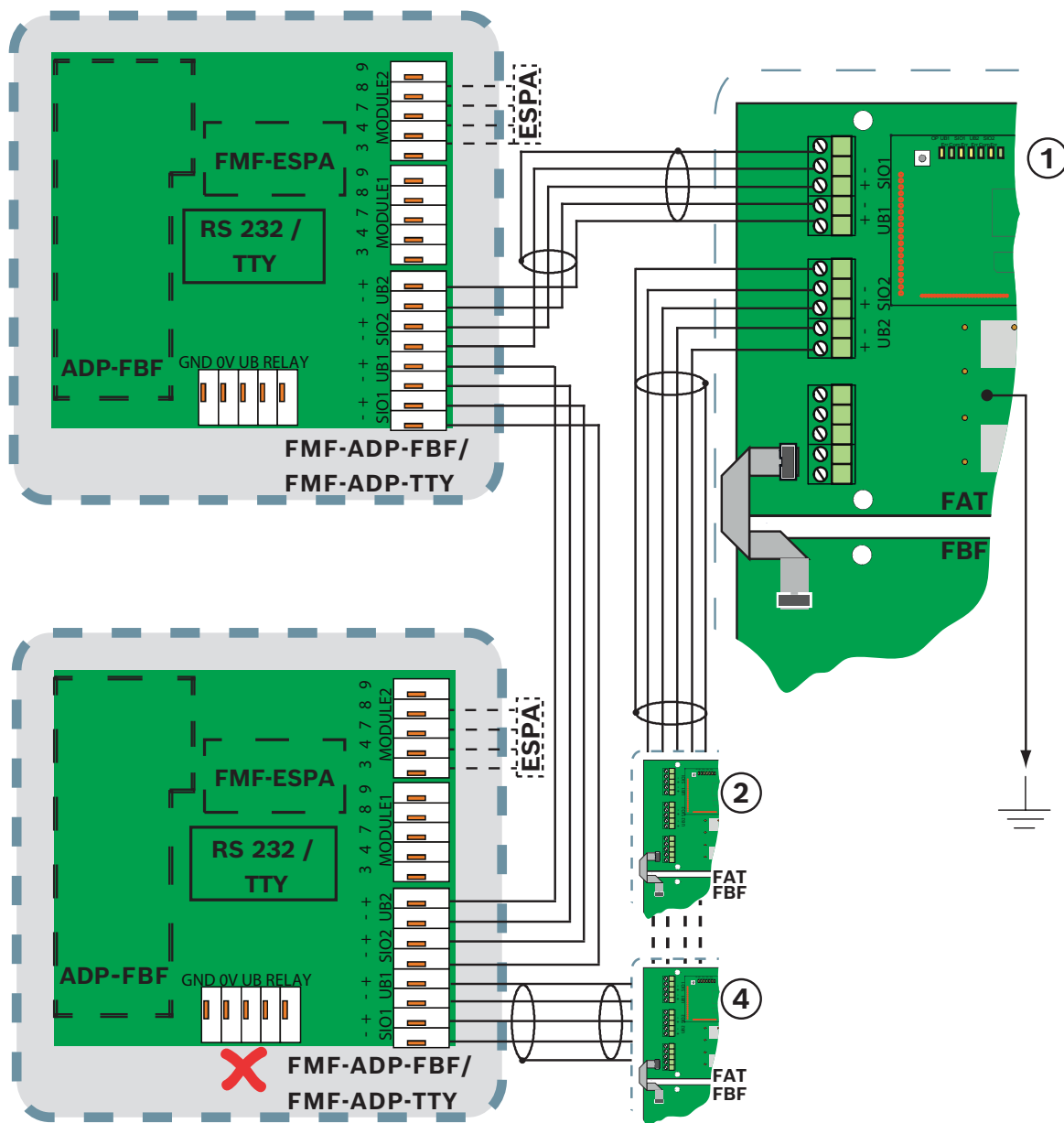

## 2.6

### EOL



*CZM 0004 A, pagina 189*

*LSN 0300 A, pagina 201*

*FLM-420/4-CON-S/D, pagina 246*

2.6.1

CZM 0004 A

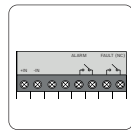

016519, 016589  
IR3 Flame Detector

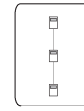

ELS

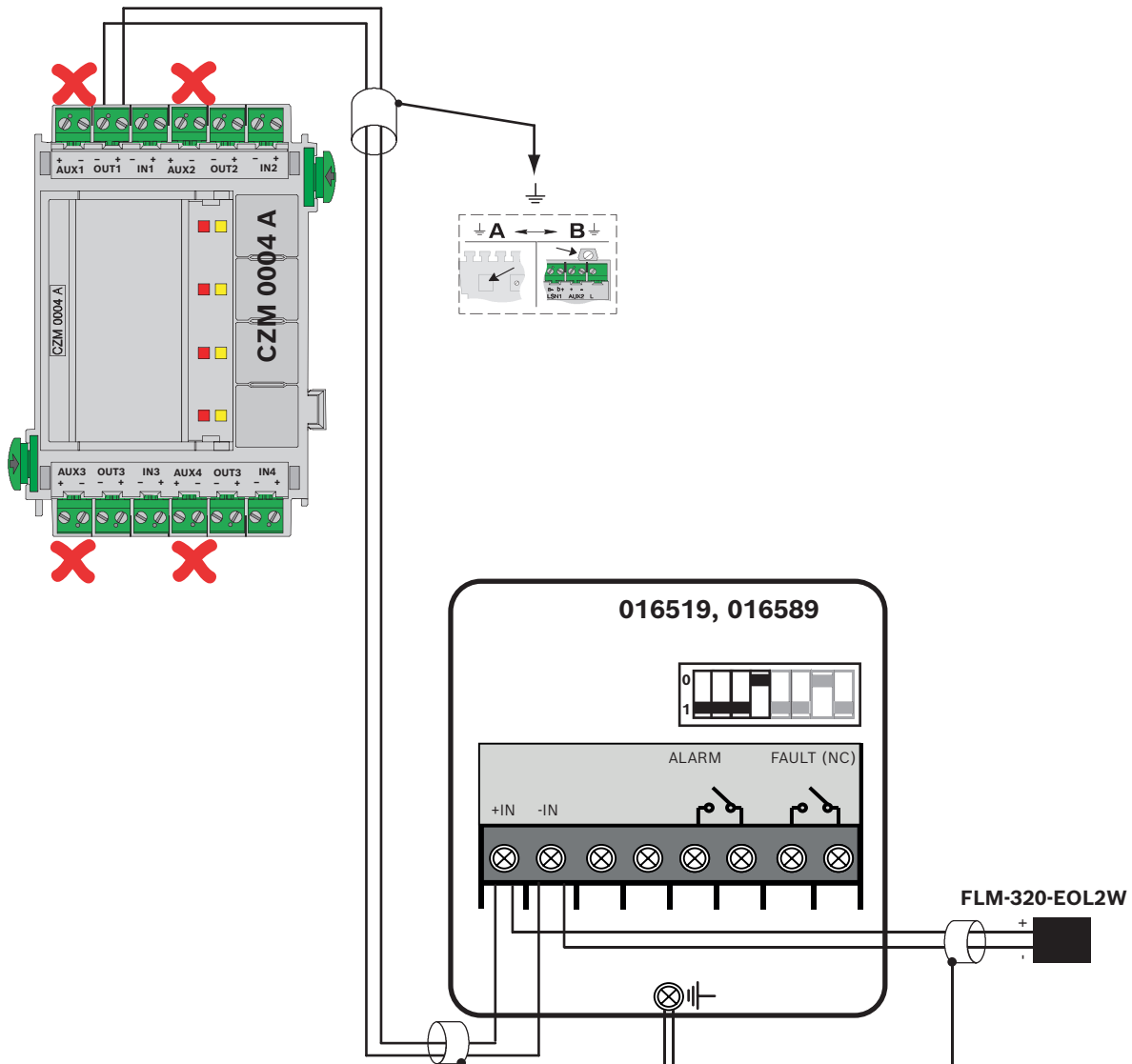

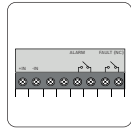

016519, 016589  
IR3 Flame Detector

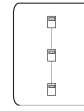

ELS

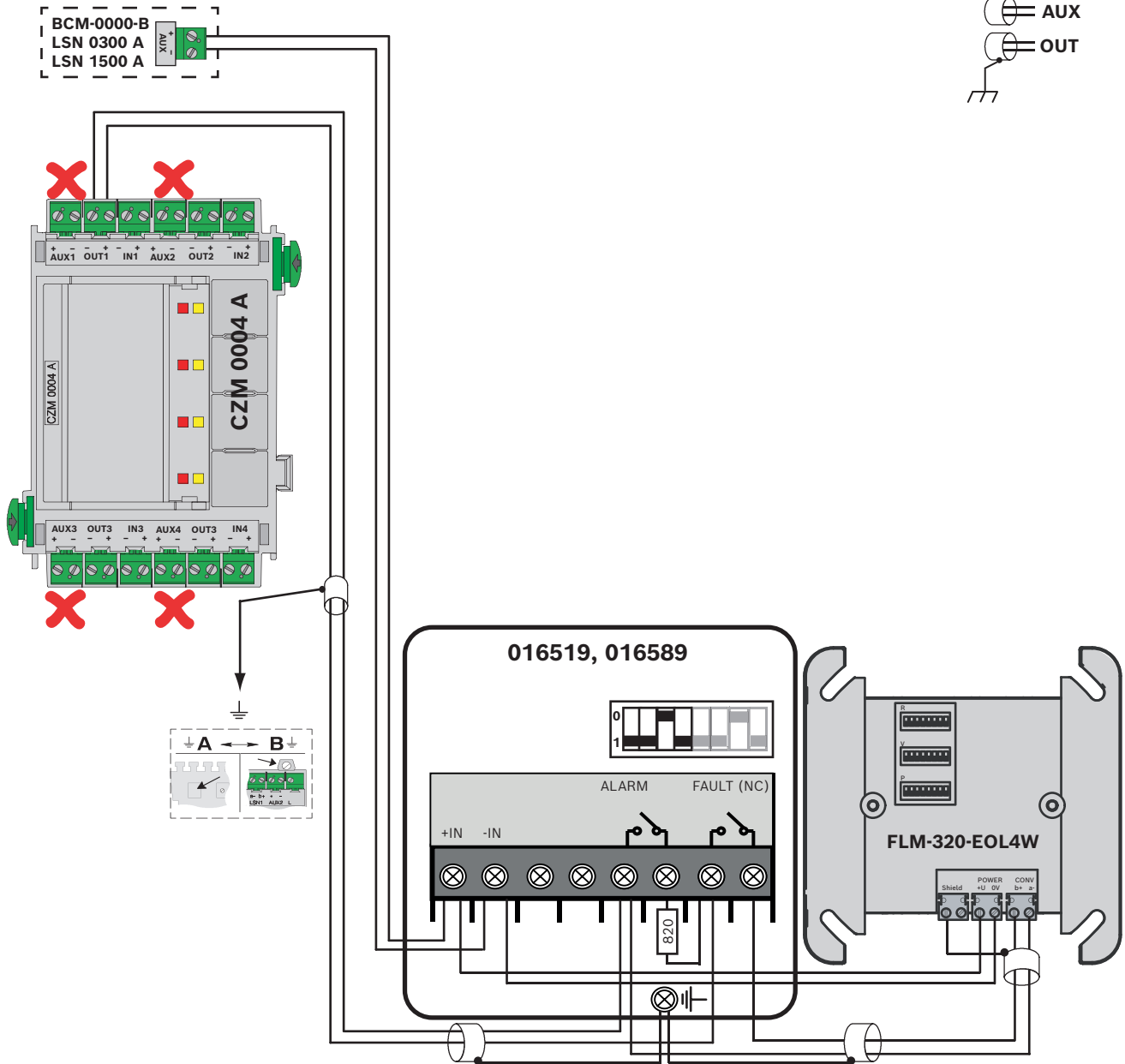



FCA-500-EU  
FCP-O 500  
FCP-O 500-P  
FCP-OC 500  
FCP-OC 500-P



ELS

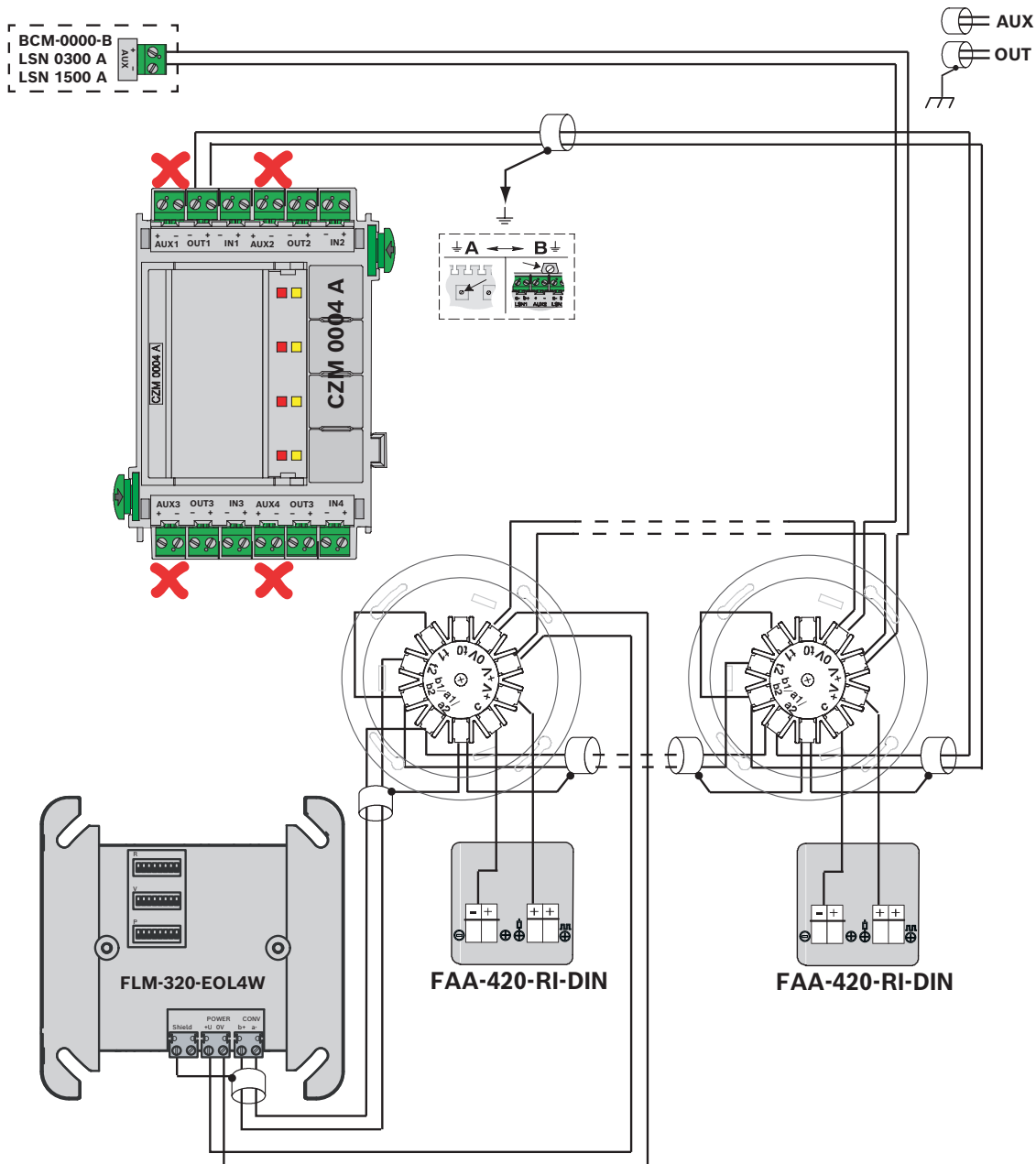

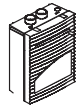

FCS-320-TM Series

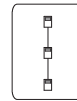

ELS

BCM-0000-B  
LSN 0300 A  
LSN 1500 A

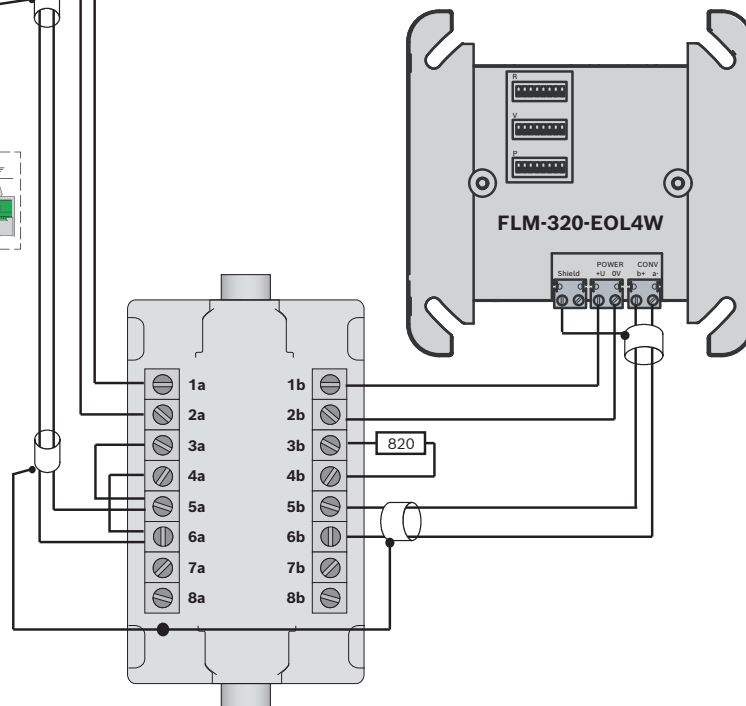
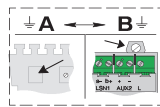
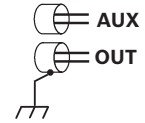
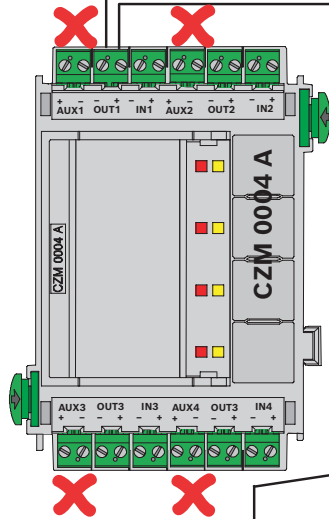

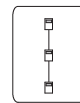

ELS

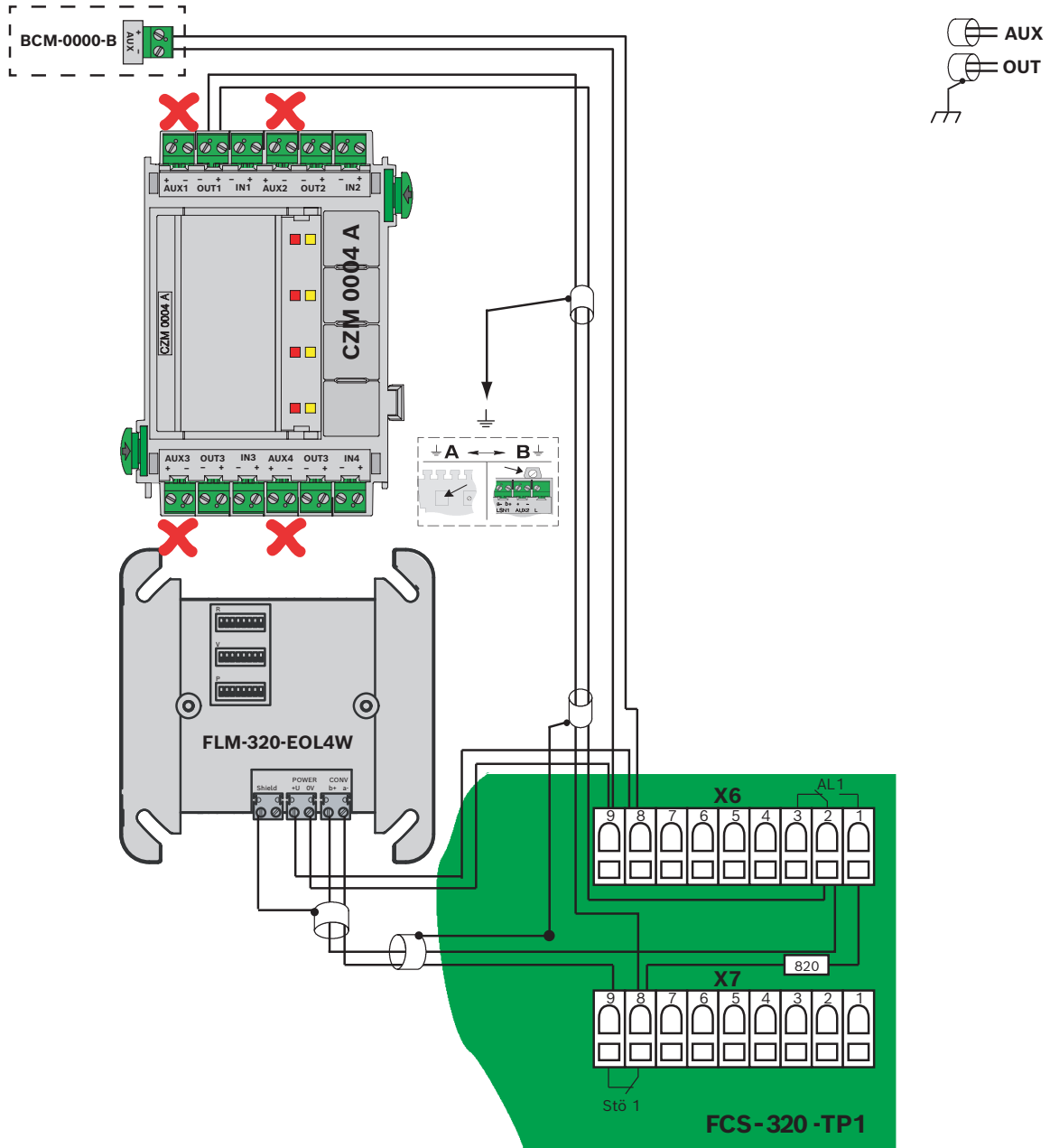

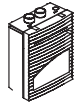

FCS-320-TP2



ELS

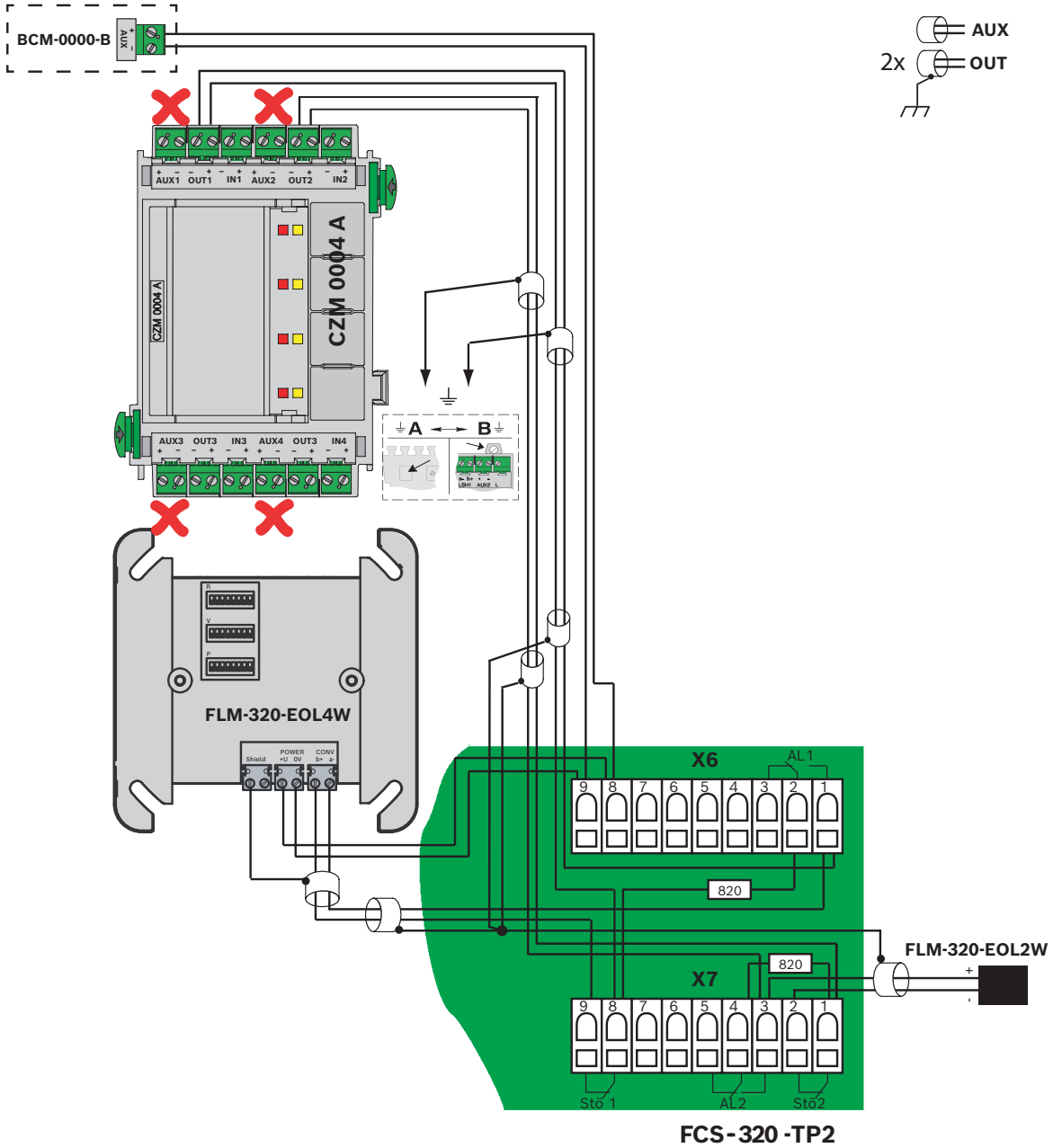





**FIRERAY3000**

1 x



**ELS**

BCM-0000-B  
LSN 0300 A  
LSN 1500 A

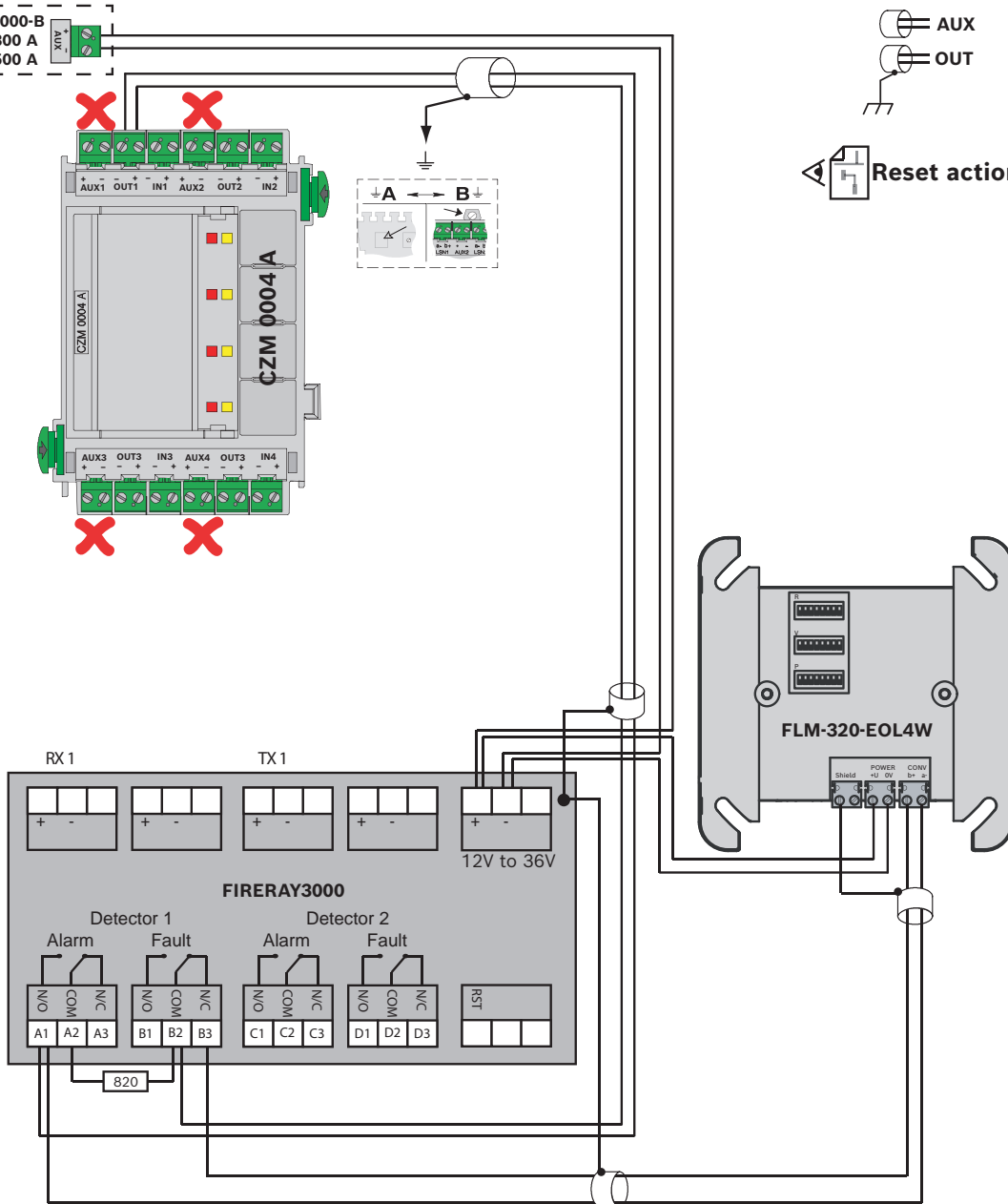

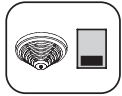

**FIRERAY3000**  
2 x  **OUT1**



**ELS**

BCM-0000-B  
LSN 0300 A  
LSN 1500 A

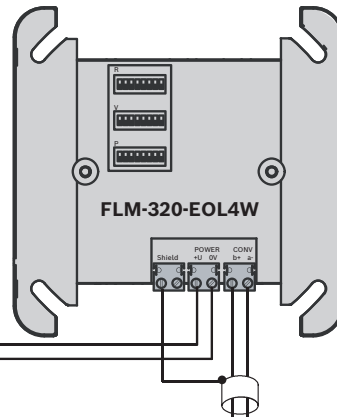
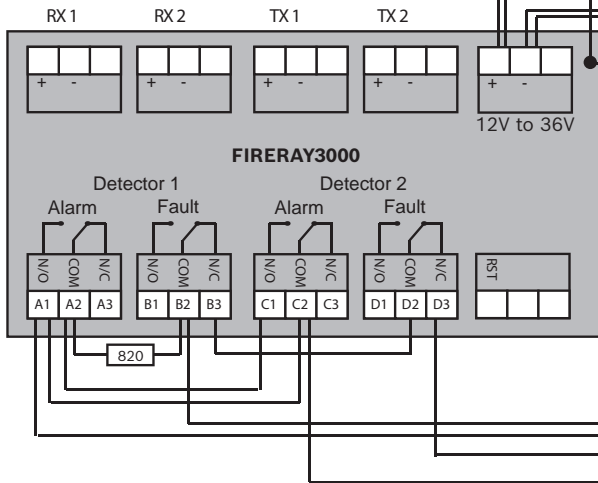
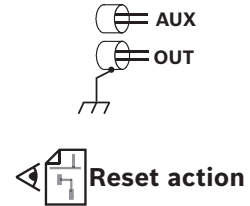
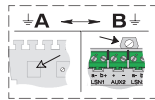
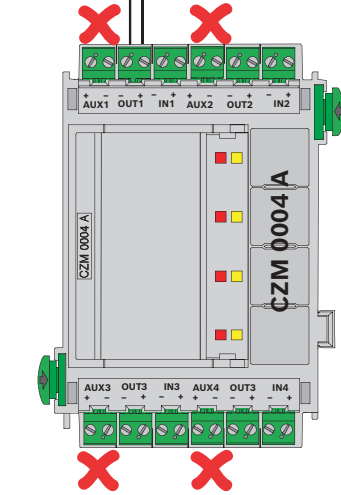



**FIRERAY3000**  
2 x **OUT1+2**



**ELS**

BCM-0000-B  
LSN 0300 A  
LSN 1500 A

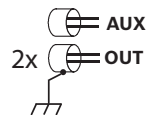
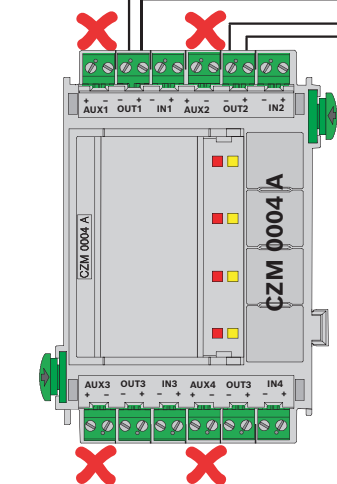

**Reset action**

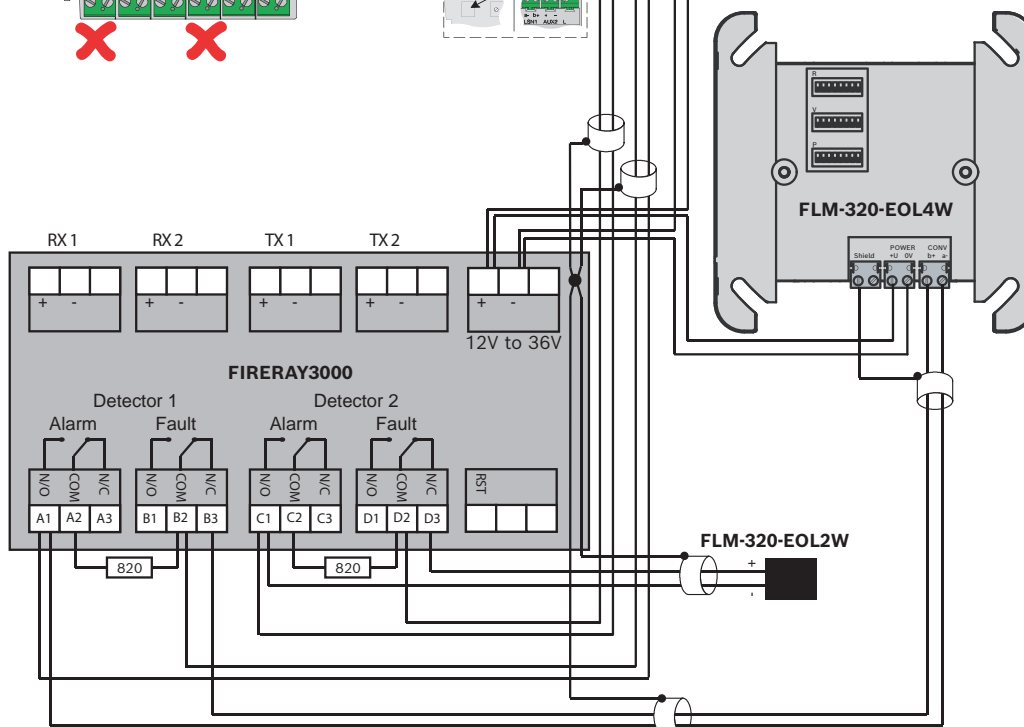

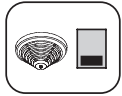

**FIRERAY5000**

1 x



**ELS**

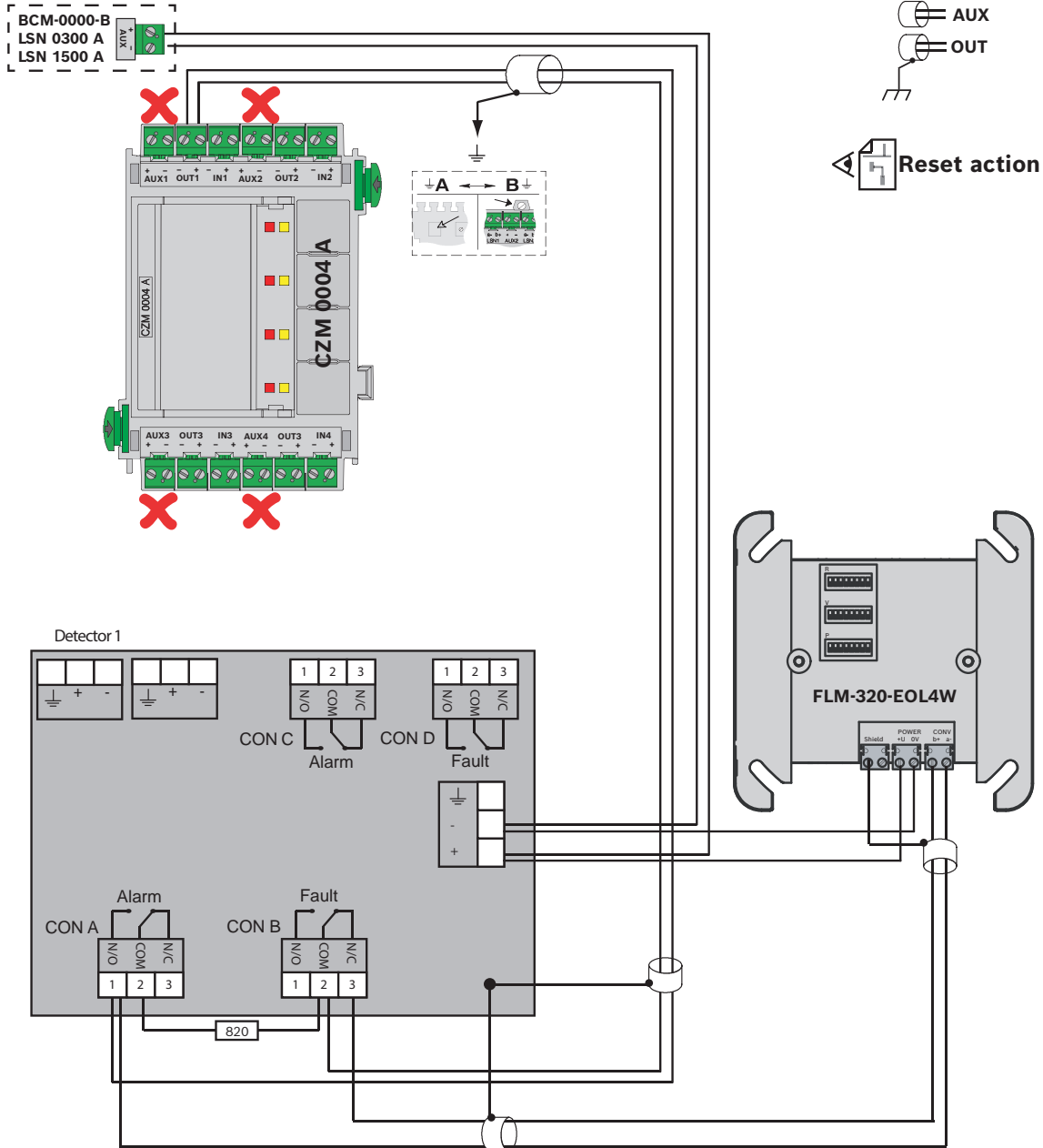

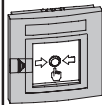
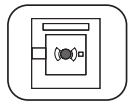

FMC-120-DKM-G-R  
 FMC-120-DKM-H-R  
 FMC-120-DKM-G-B  
 FMC-120-DKM-H-B  
 FMC-120-DKM-G-Y

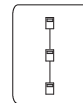

ELS

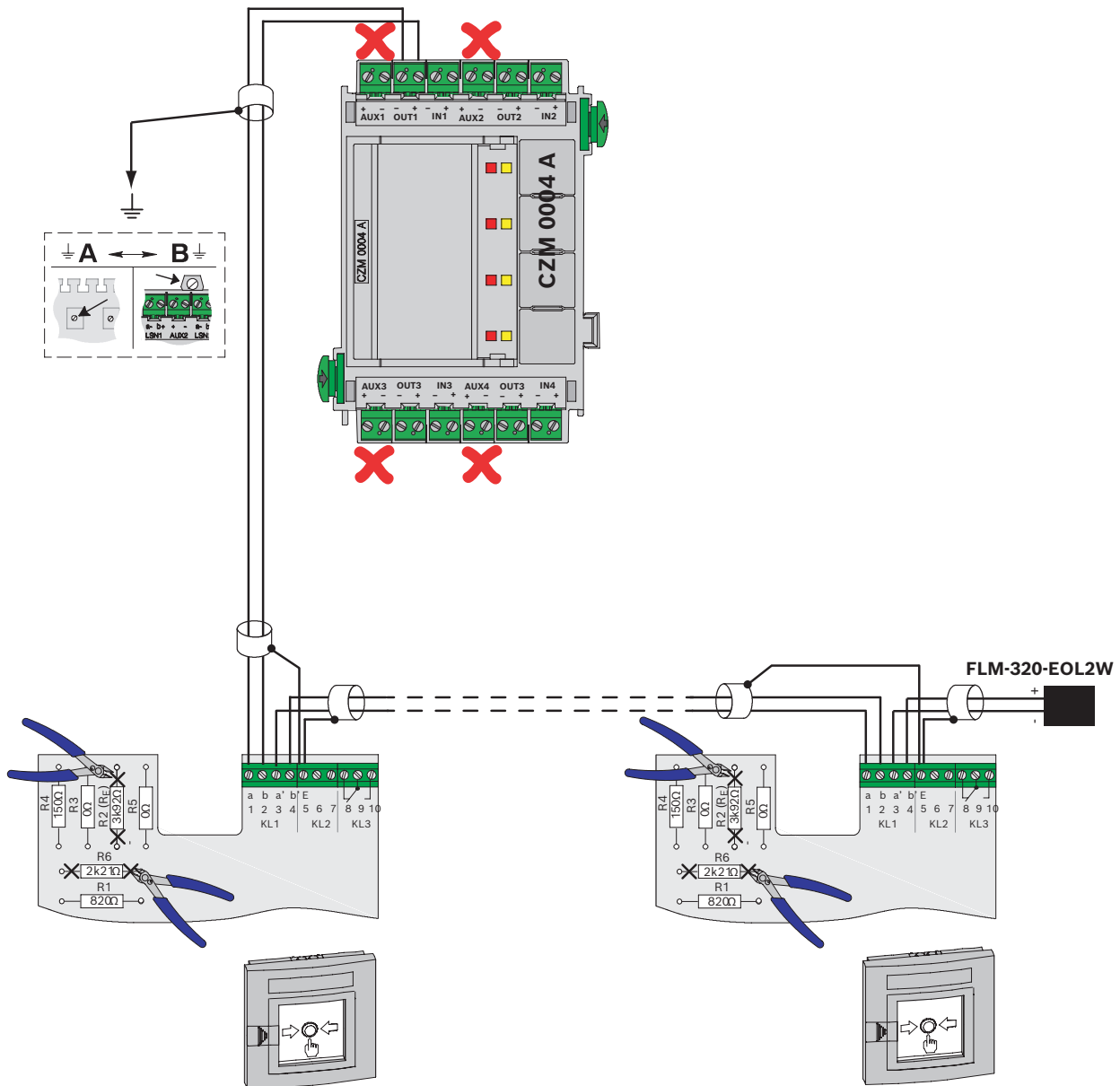



FMC-300RW-GSGBU  
FMC-300RW-GSRBU  
FMC-300RW-GSGRD  
FMC-300RW-GSRRD  
FMC-300RW-GSGYE  
FMC-300RW-GSRYE



ELS

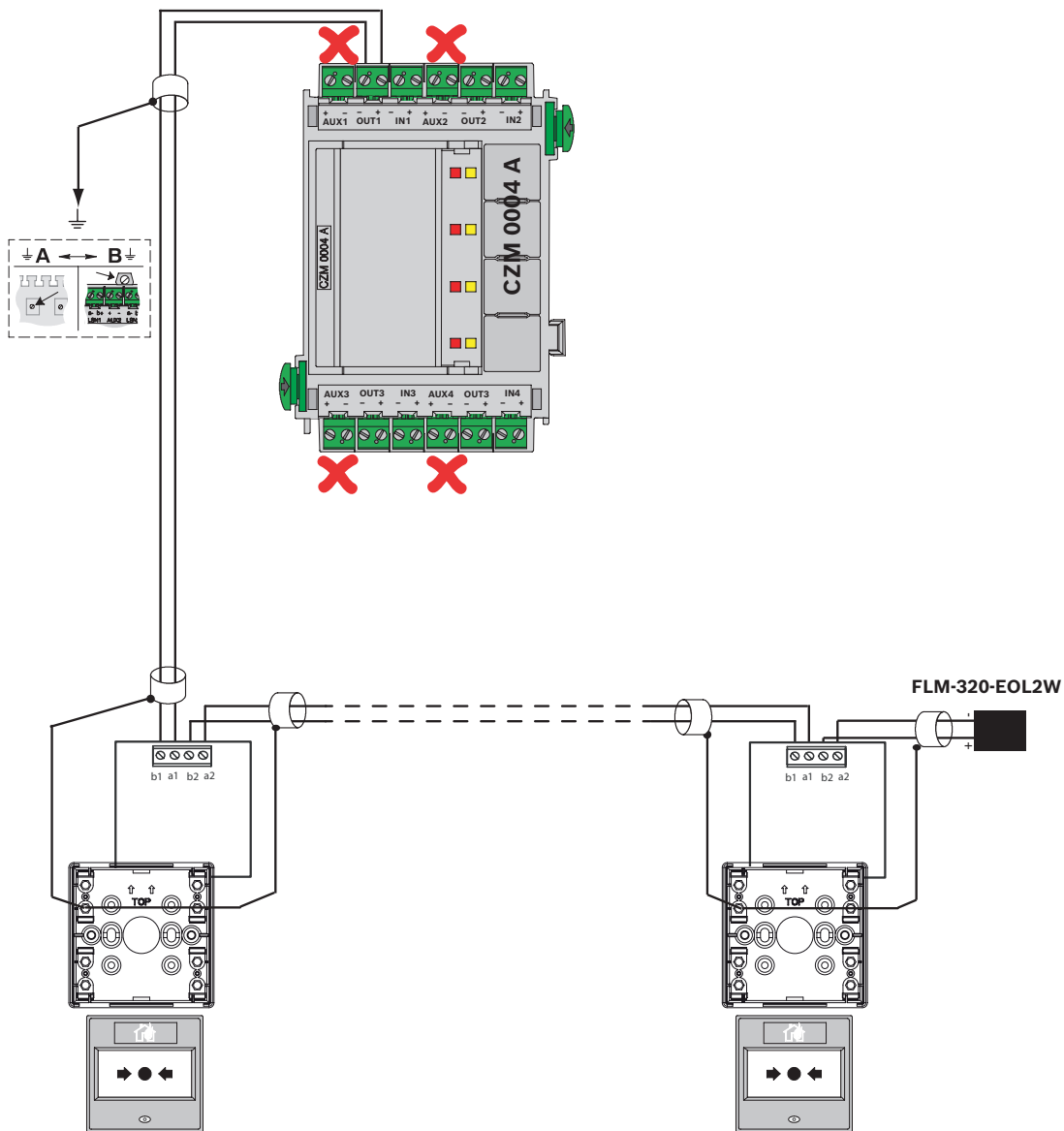

2.6.2 LSN 0300 A

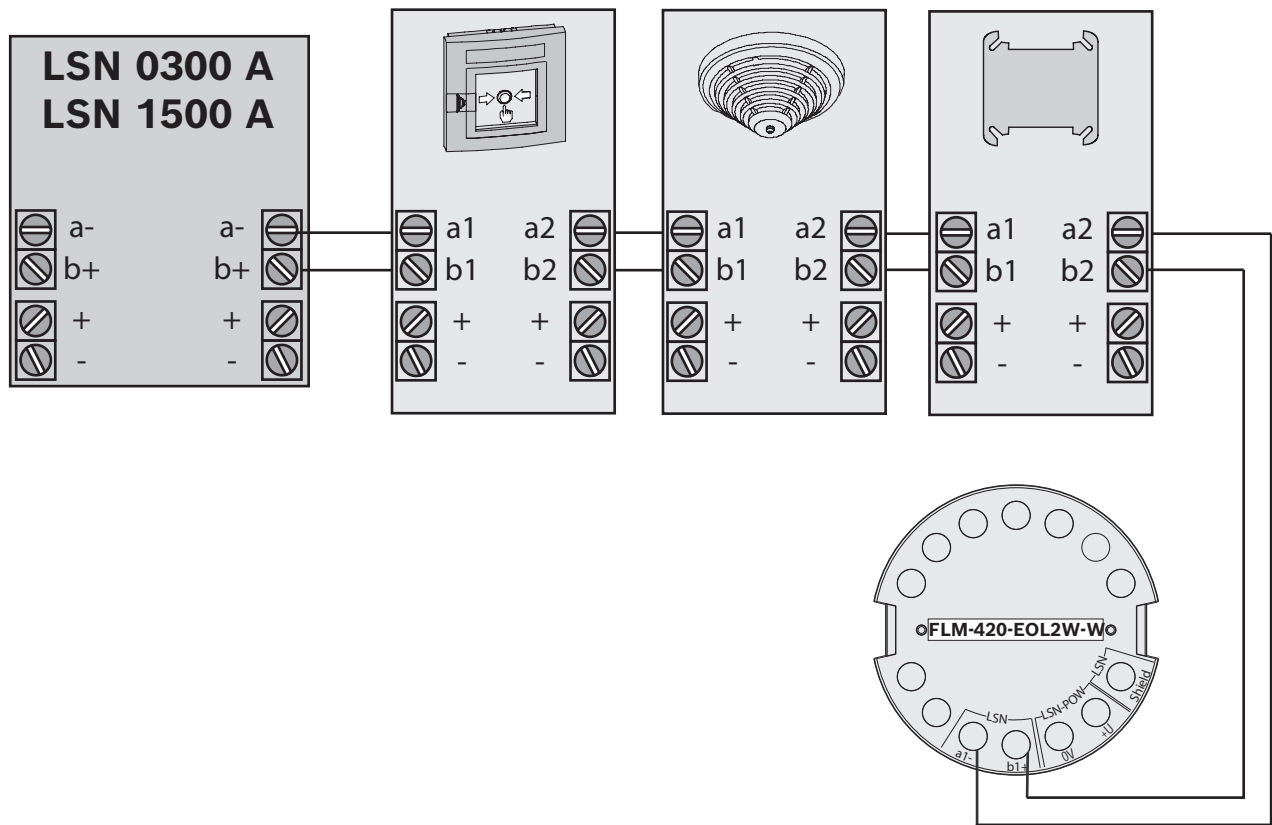
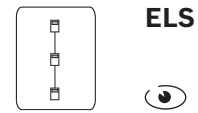

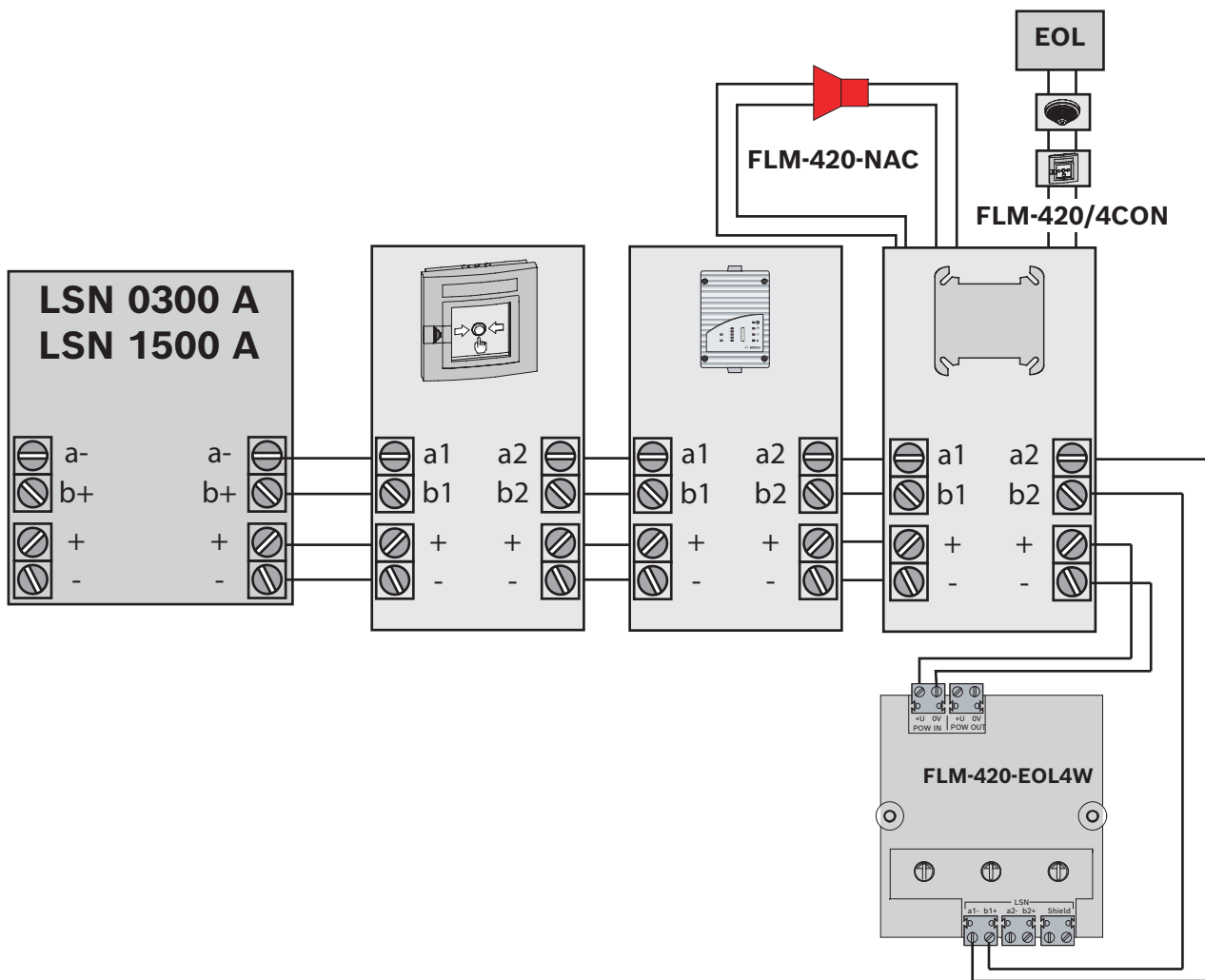
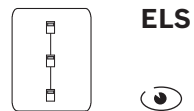



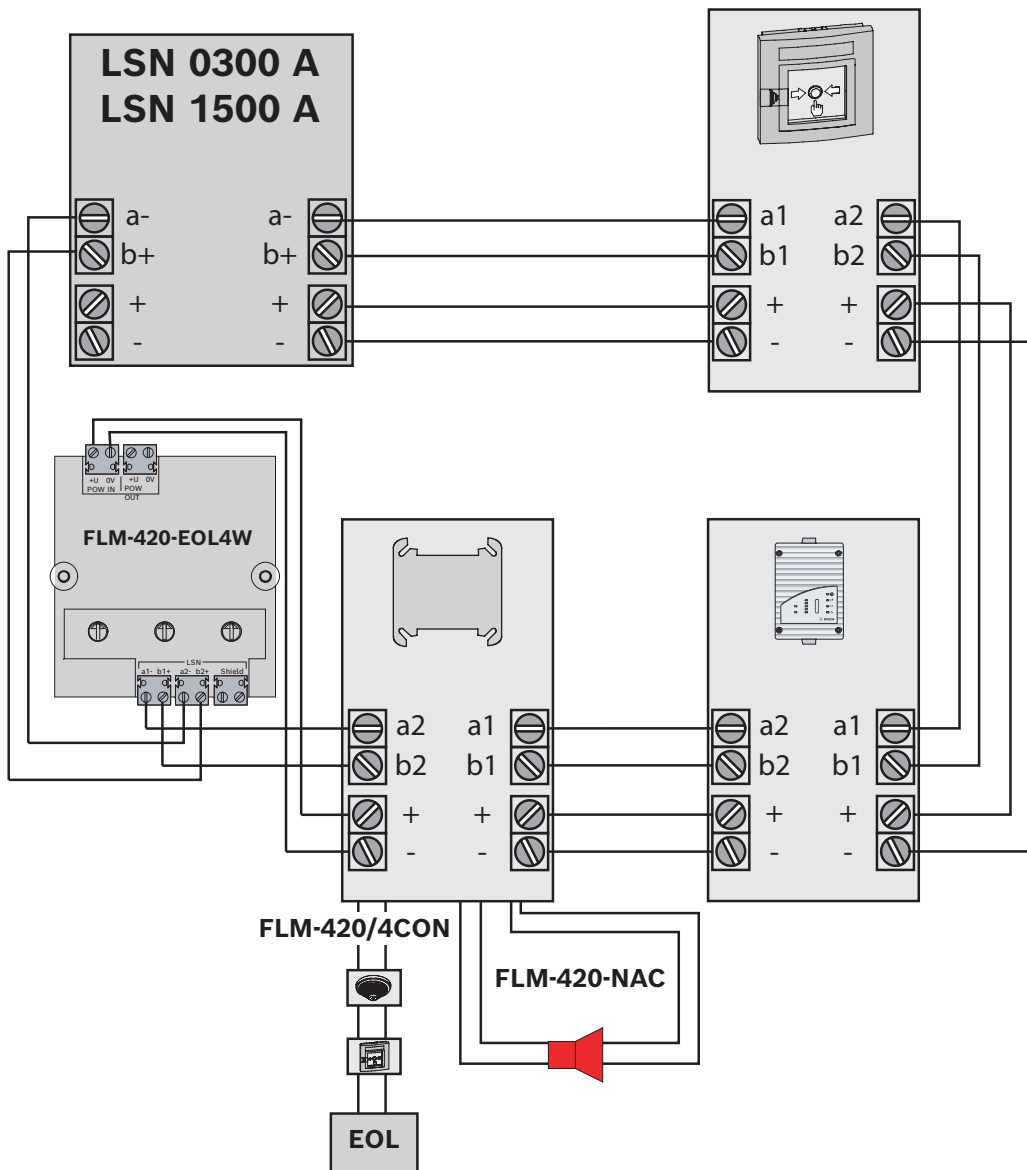
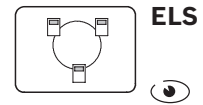

Reset action

ELS

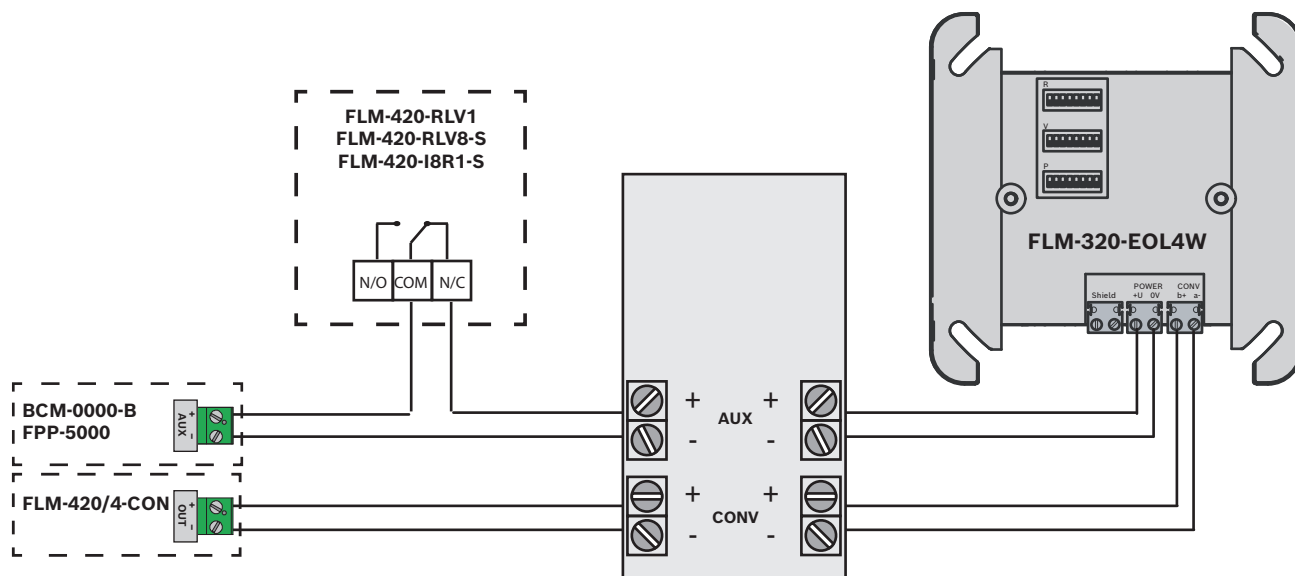

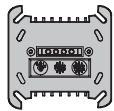
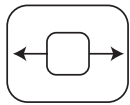

FLM-420-I2-D  
 FLM-420-O111-D  
 FLM-420-RHV-D/S  
 FLM-420-RLV1-D

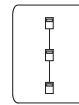

ELS

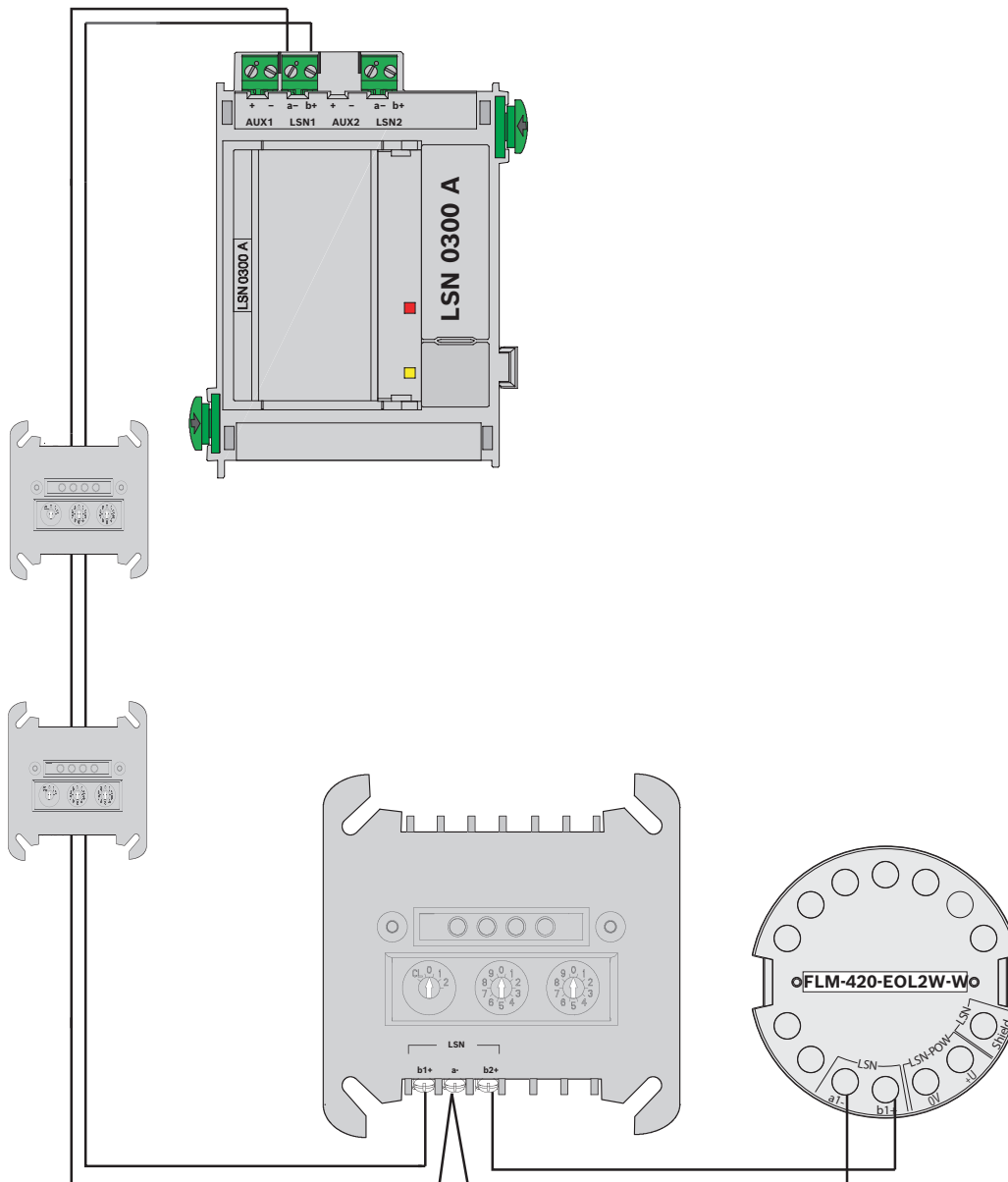

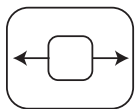

FLM-420-12-E/W

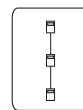

ELS

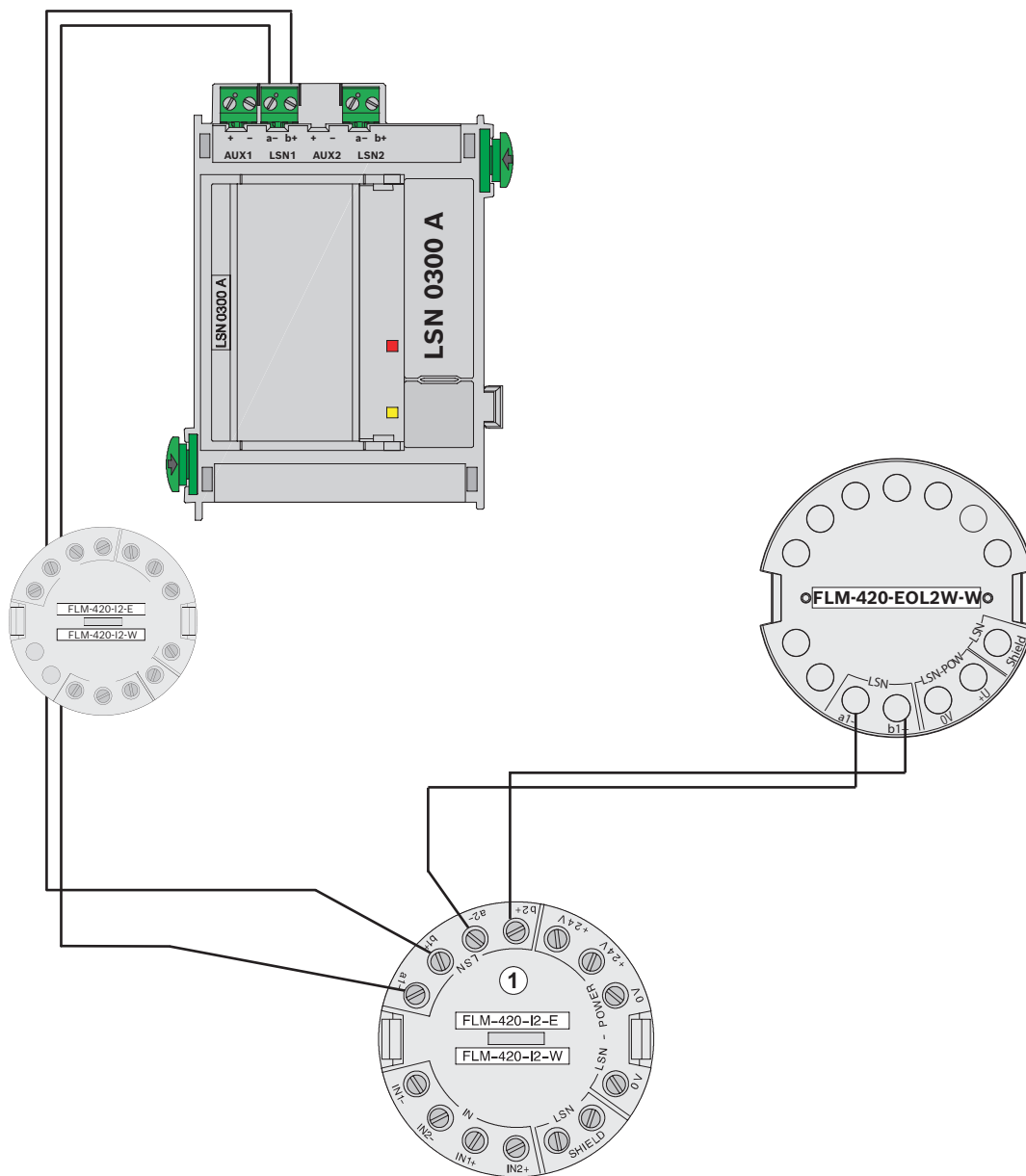

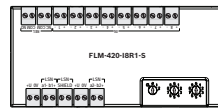
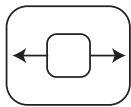

**FLM-420-18R1-S**

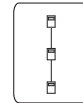

**ELS**

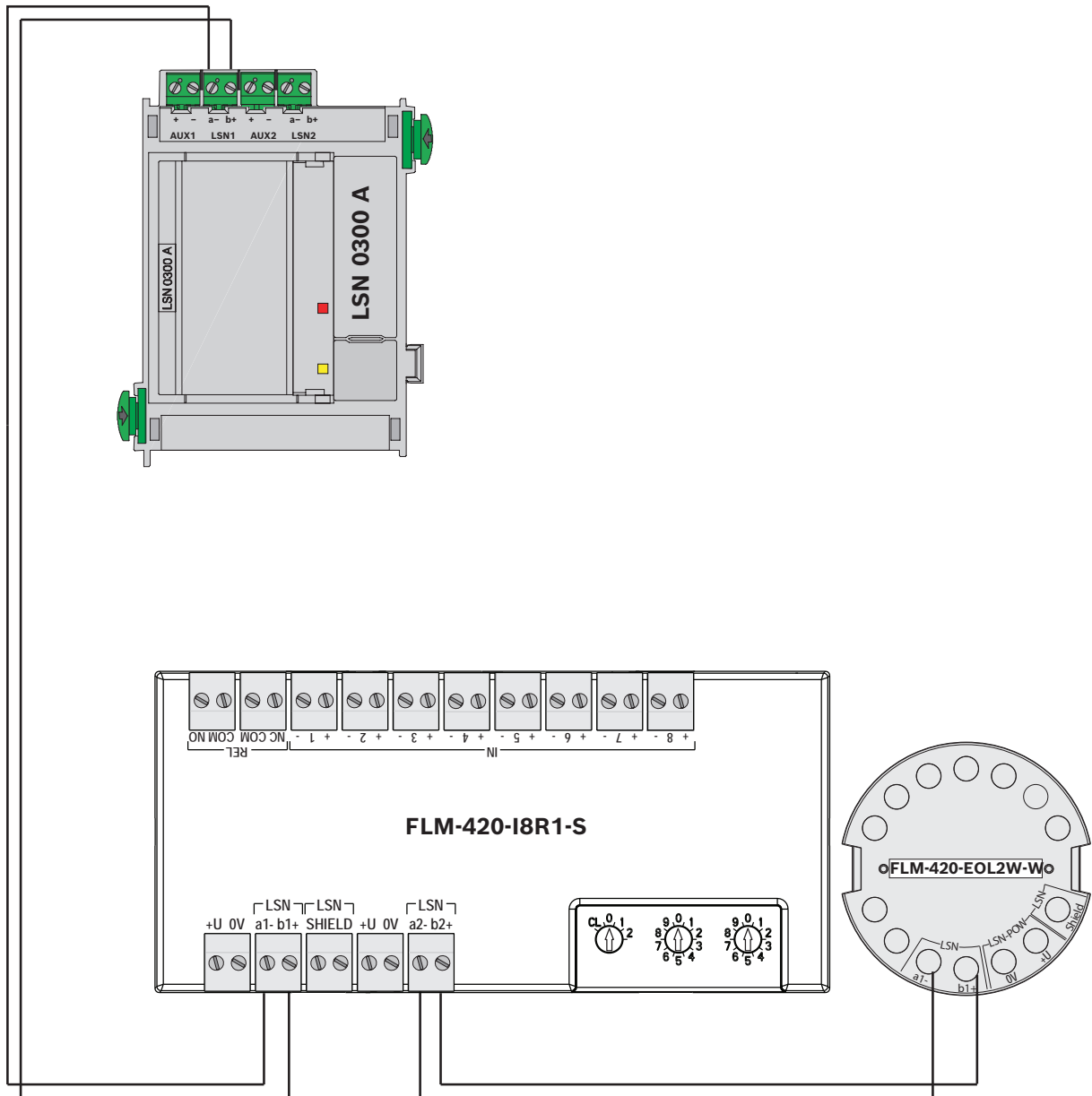

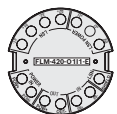
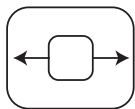

FLM-420-O111-E

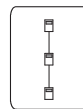

ELS

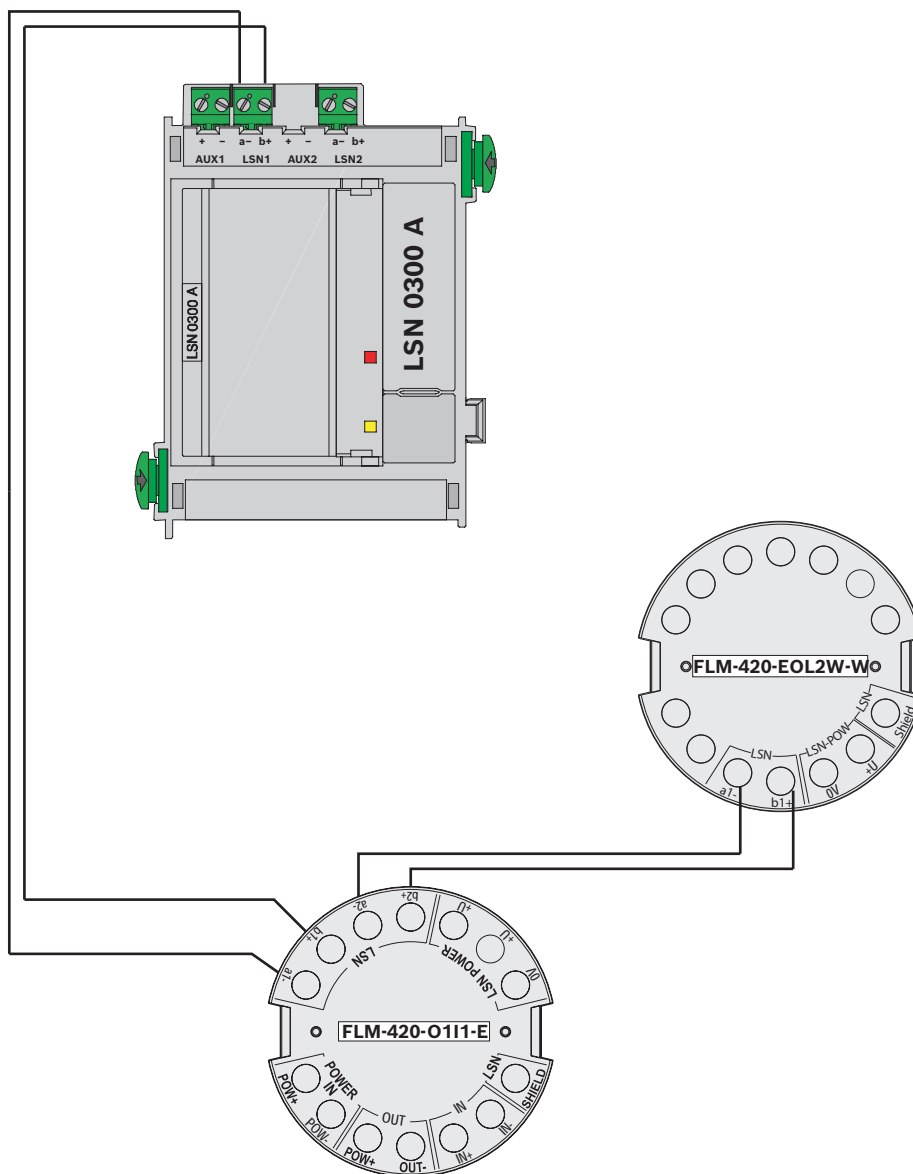

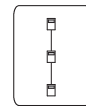
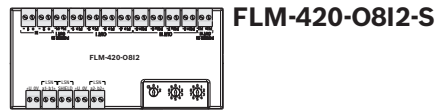
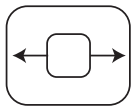

ELS

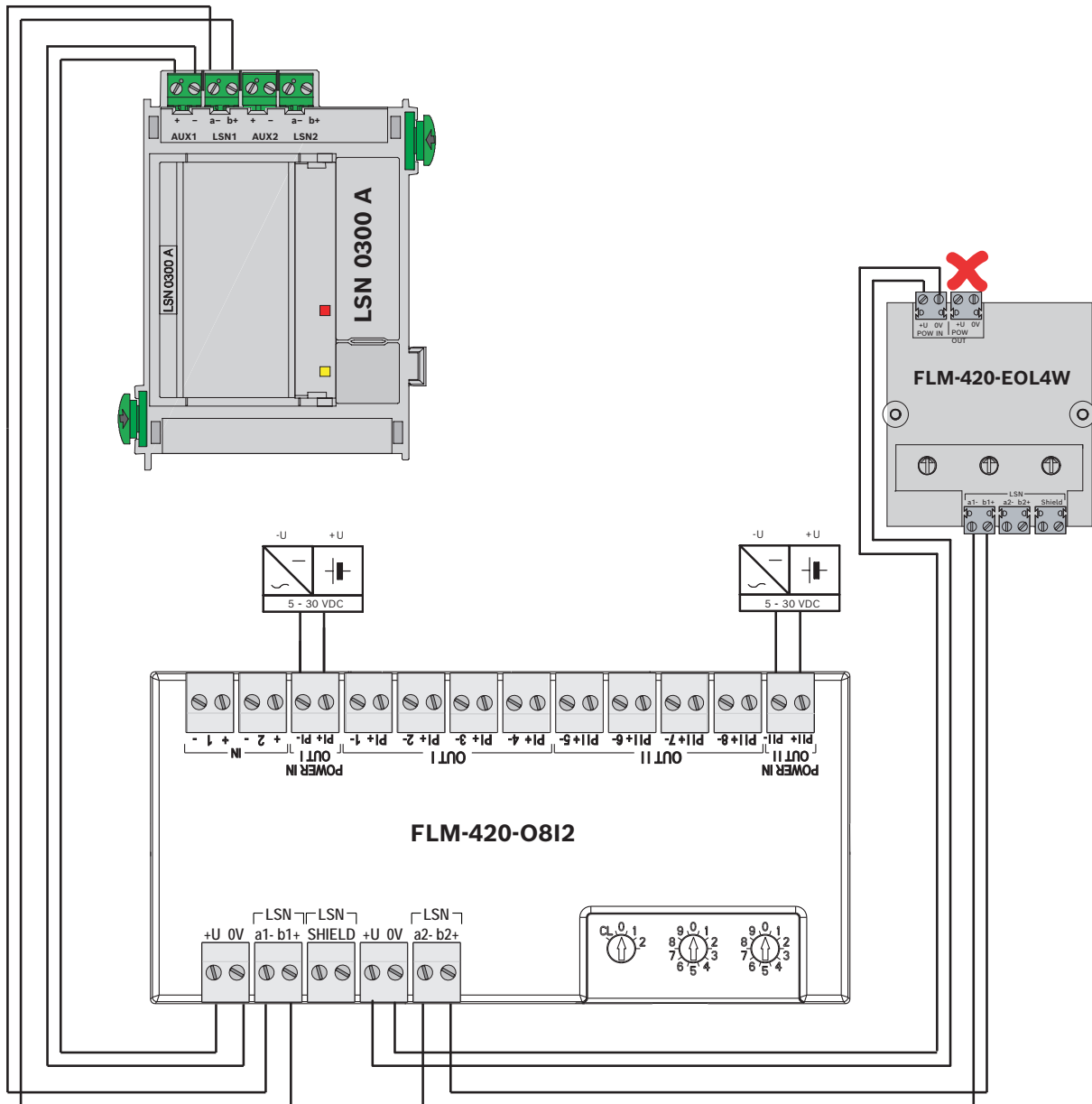

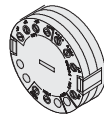
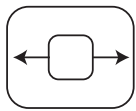

**FLM-420-I2-E/-W**  
**FLM-420-RLV1-E**

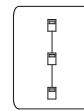

**ELS**

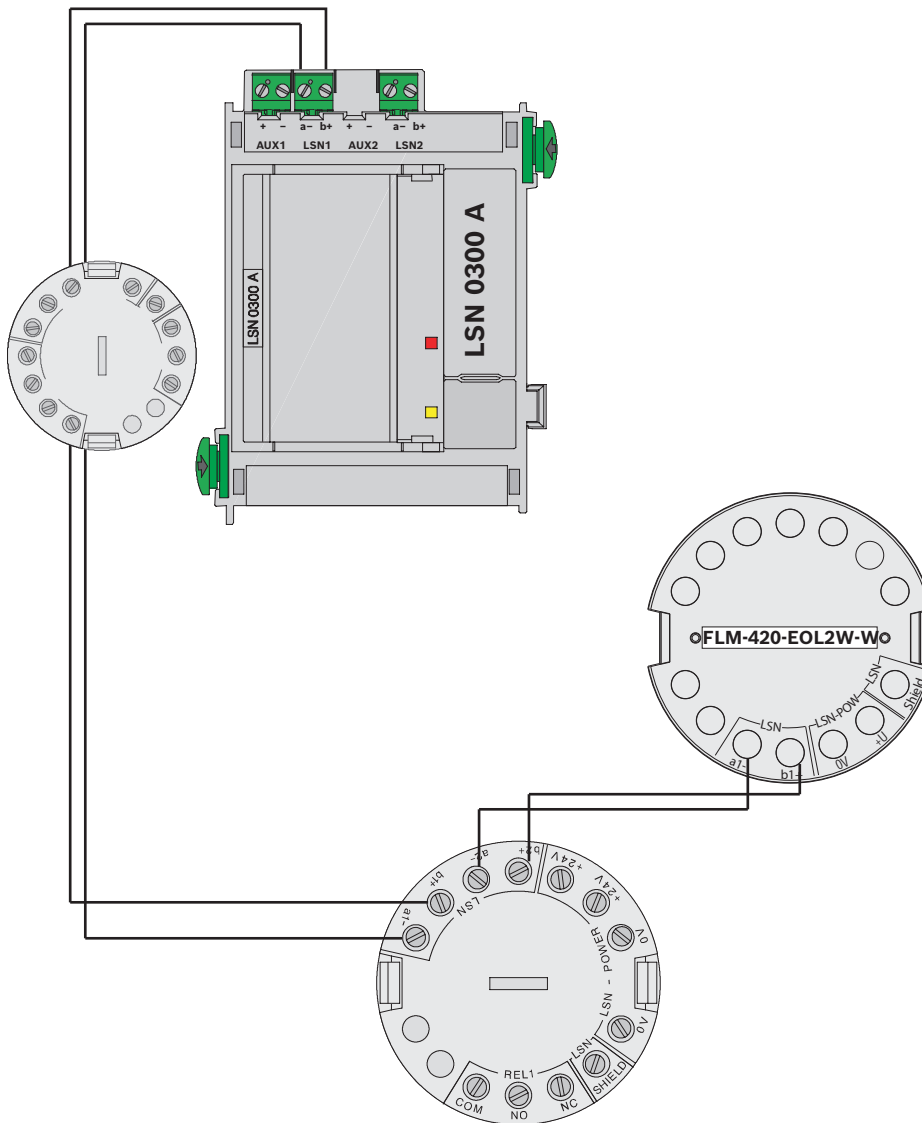



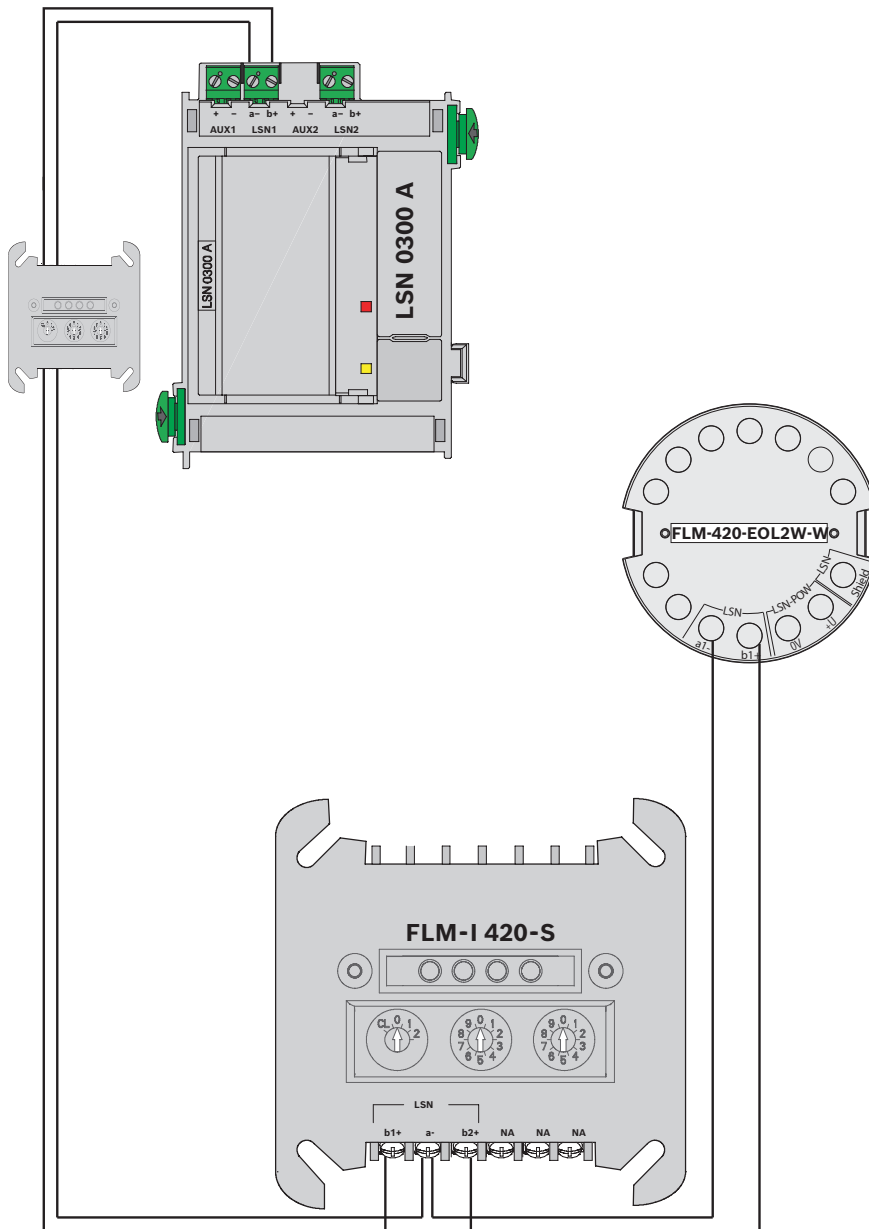
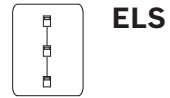
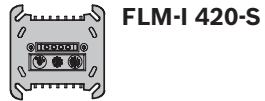
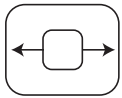

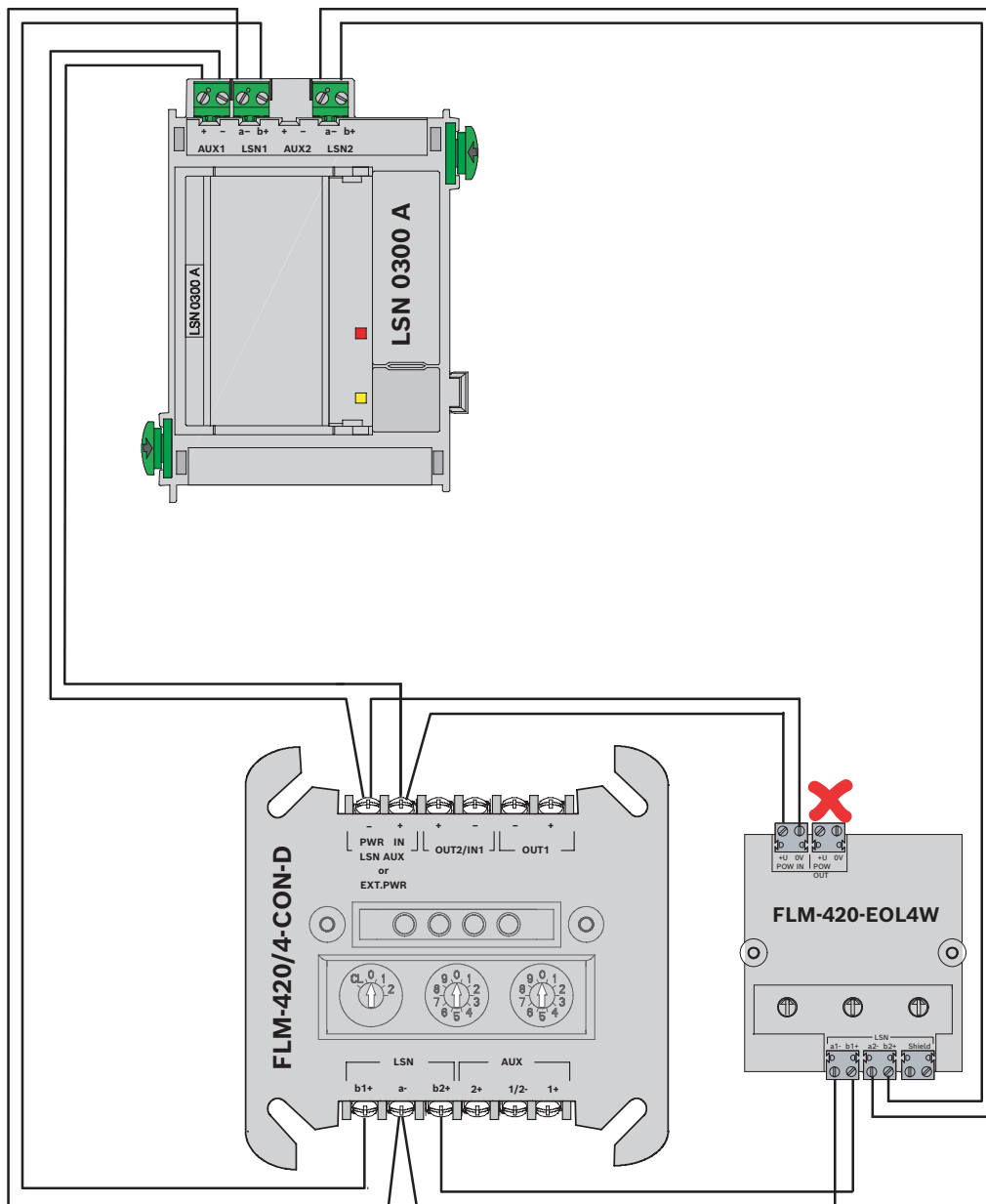
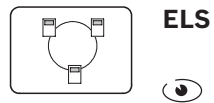
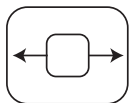

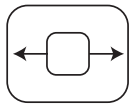

**FLM-420/  
4-CON-D**

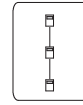

**ELS**

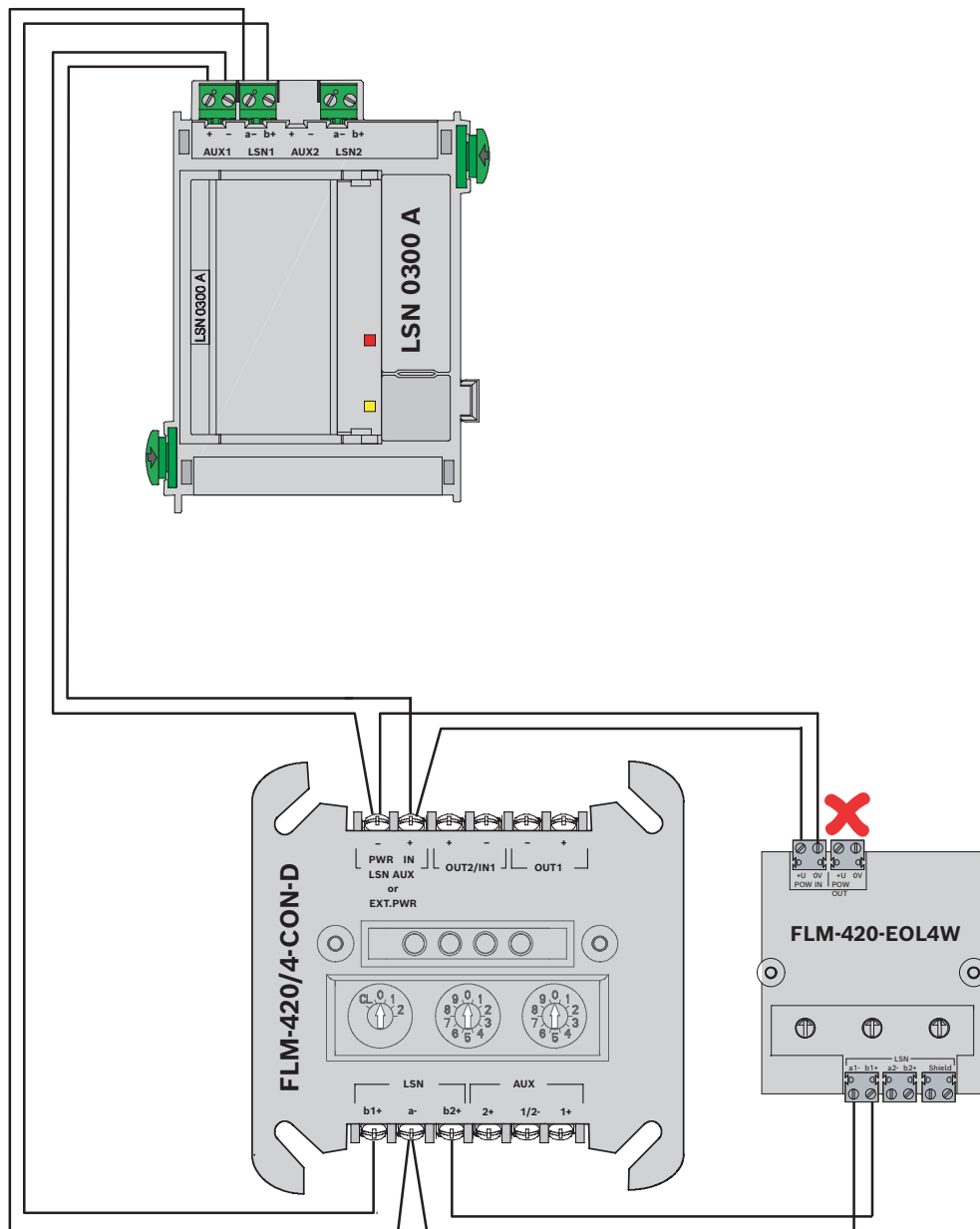

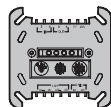
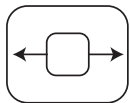

FLM-420-NAC-D/S

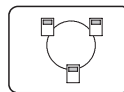

ELS  
EN 54-2

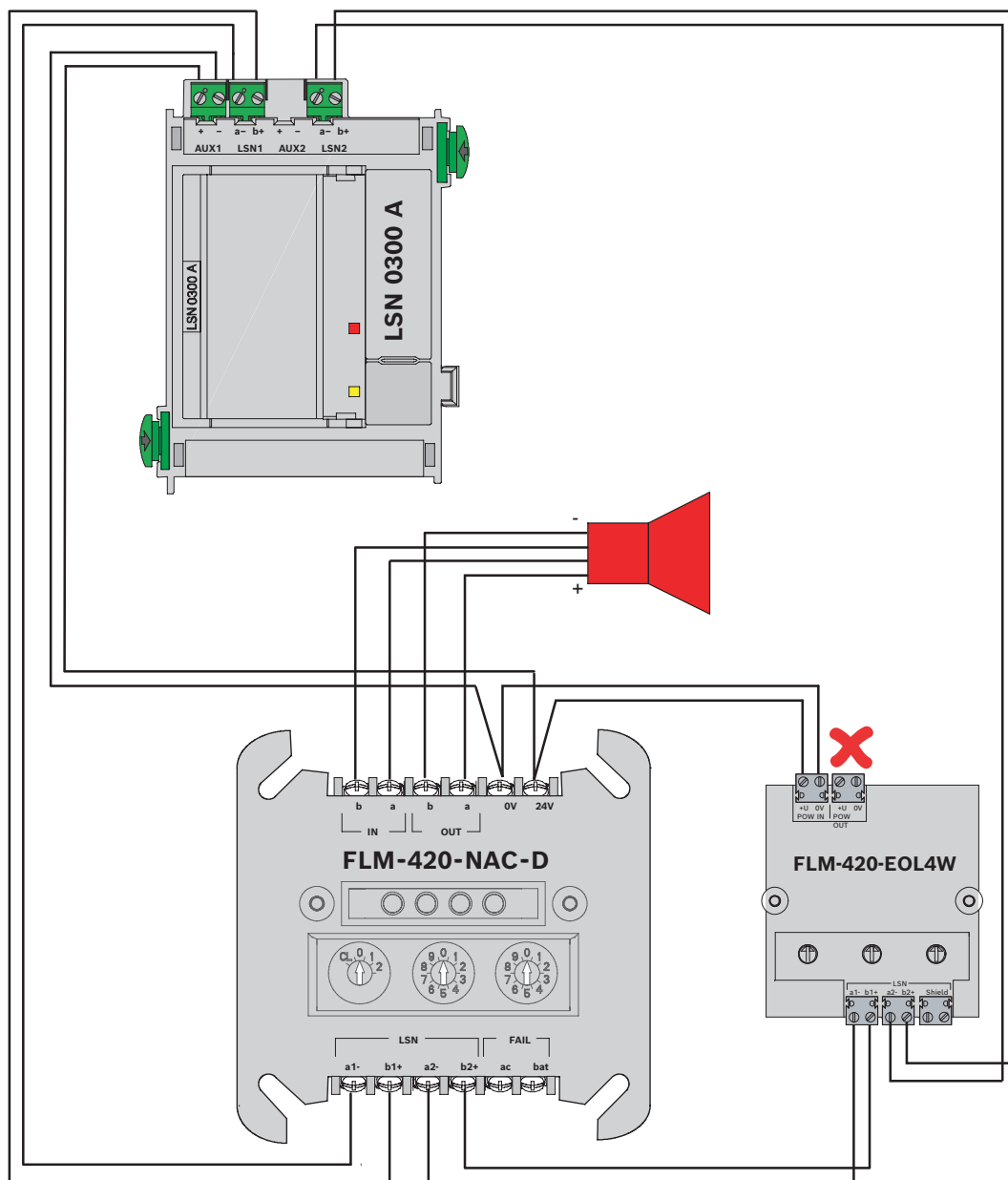

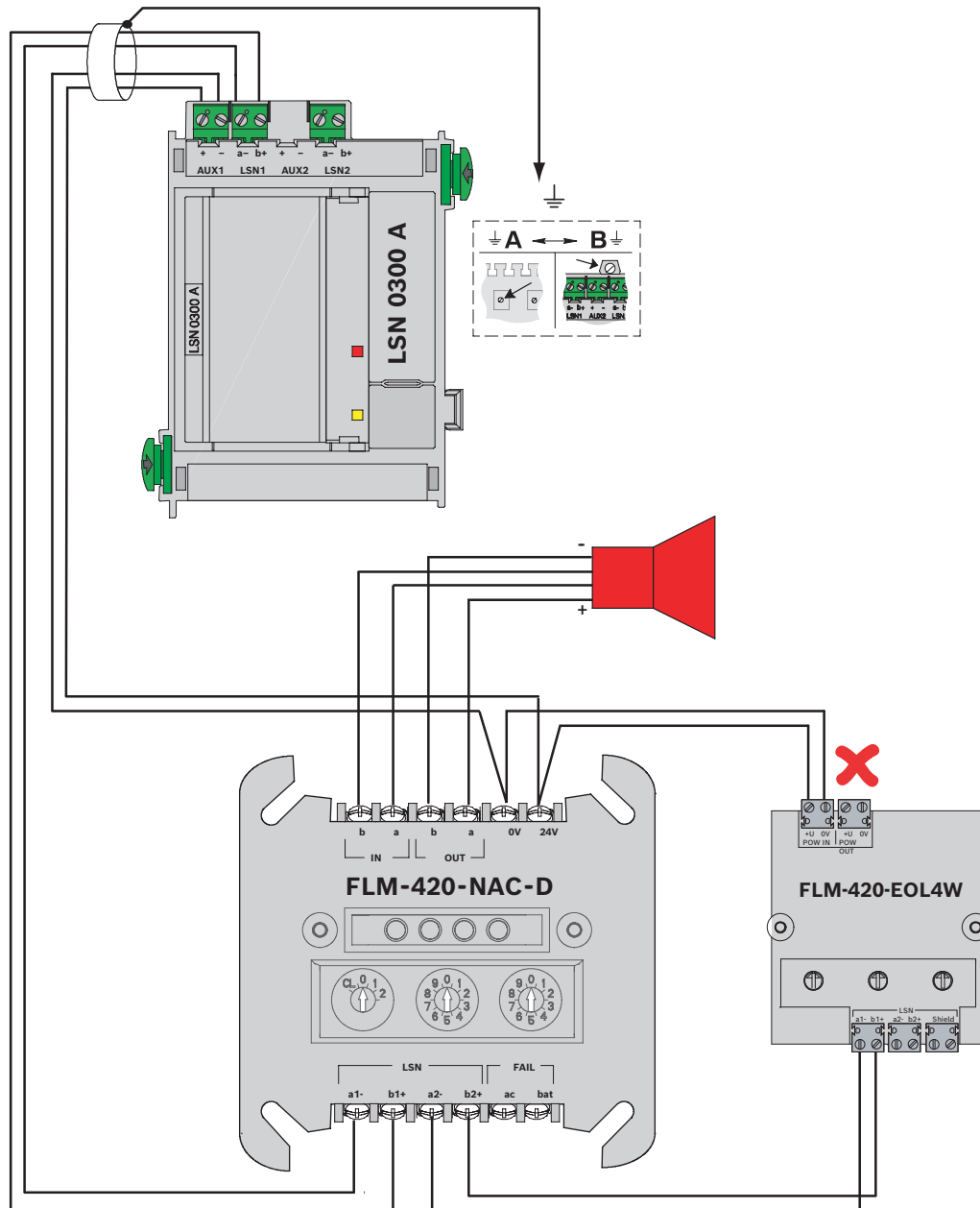
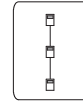
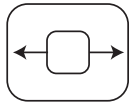

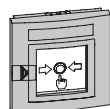
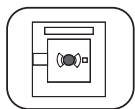

FMC-210...

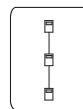

ELS

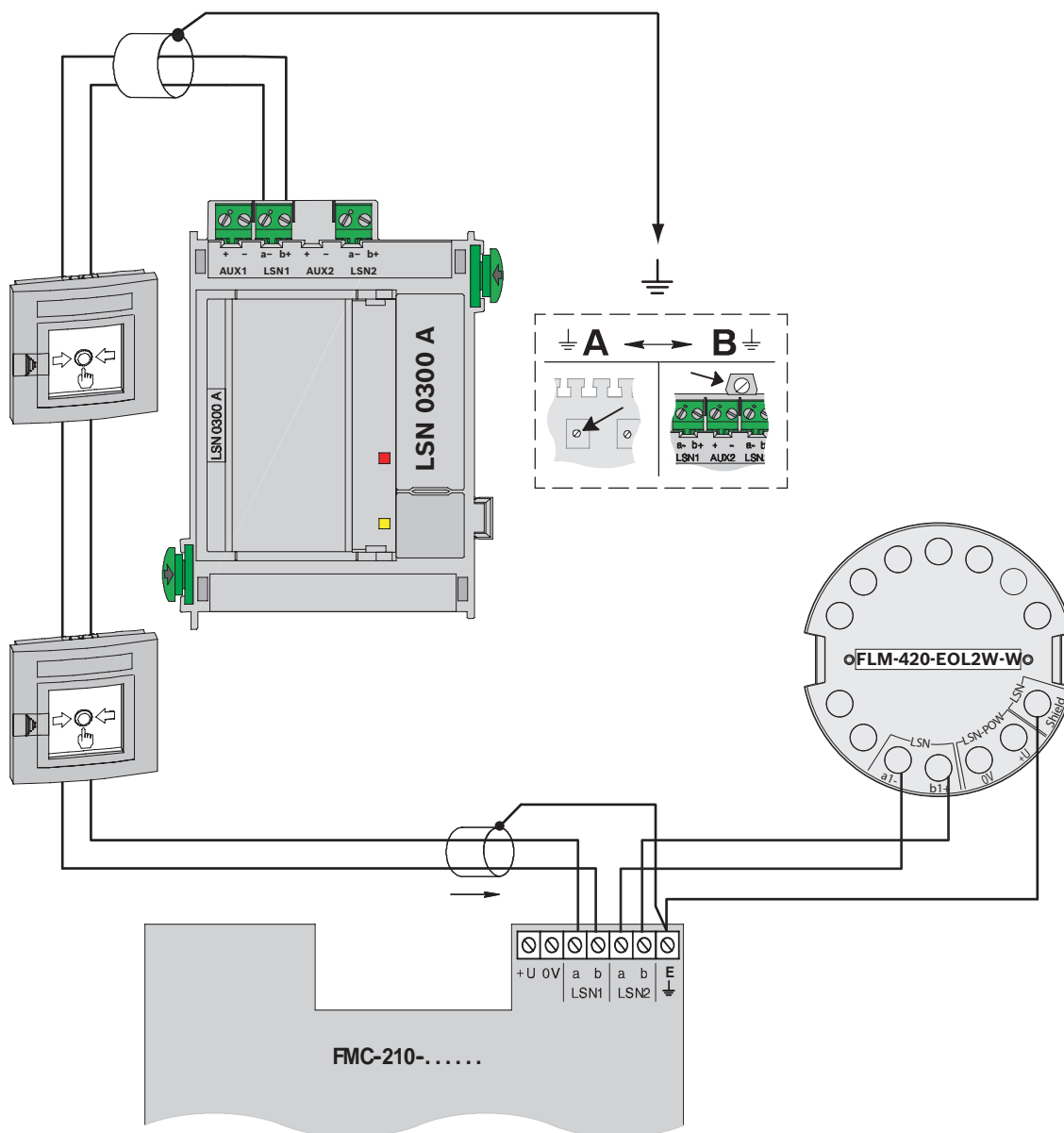

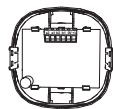

**FNM-420-A /-B**  
**FNM-420U-A /-B**  
**FNM-420V-A**

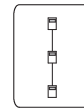

**ELS**

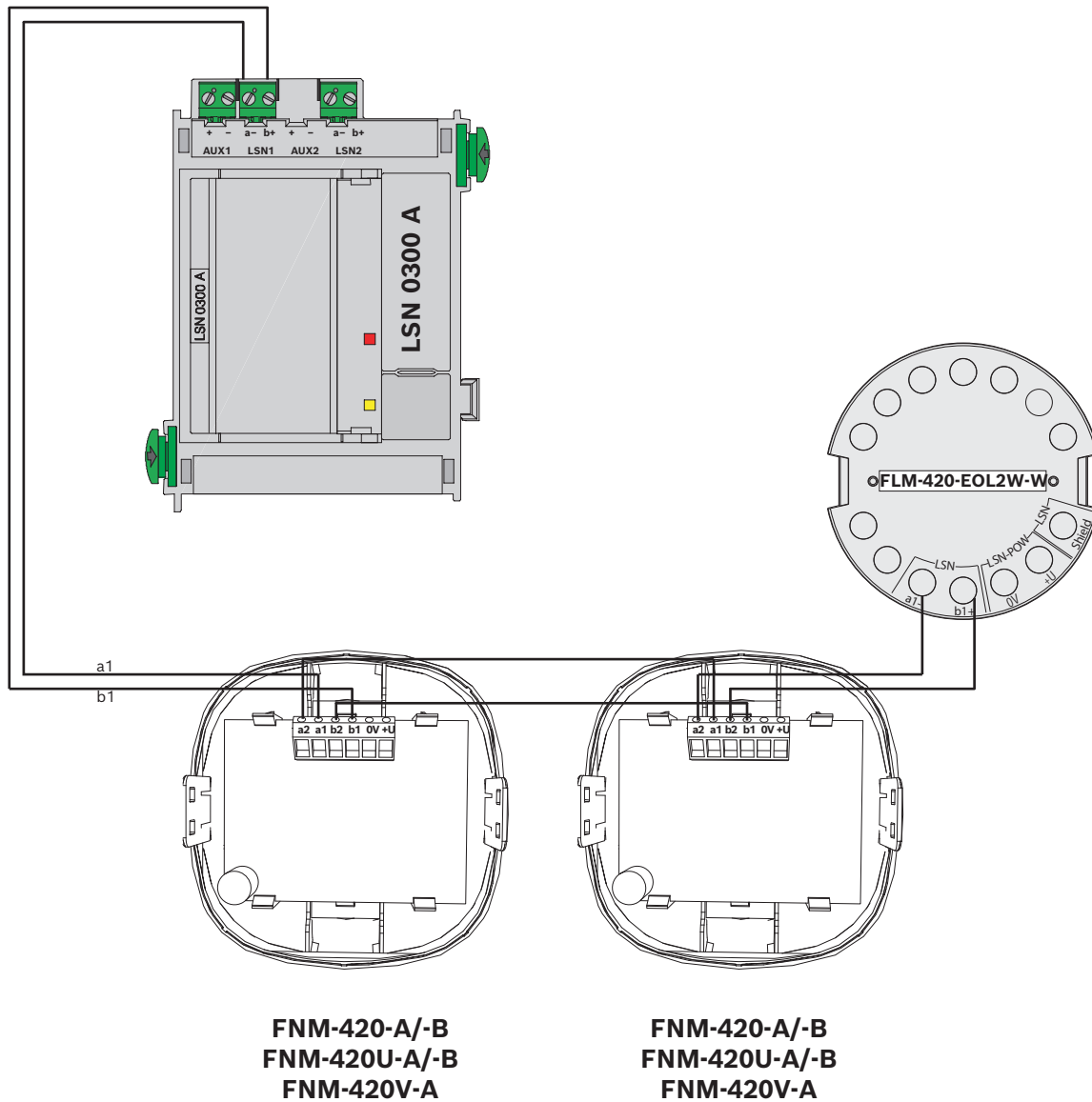



**FNM-420-A-BS**  
**FNM-420U-A-BS**



**ELS**

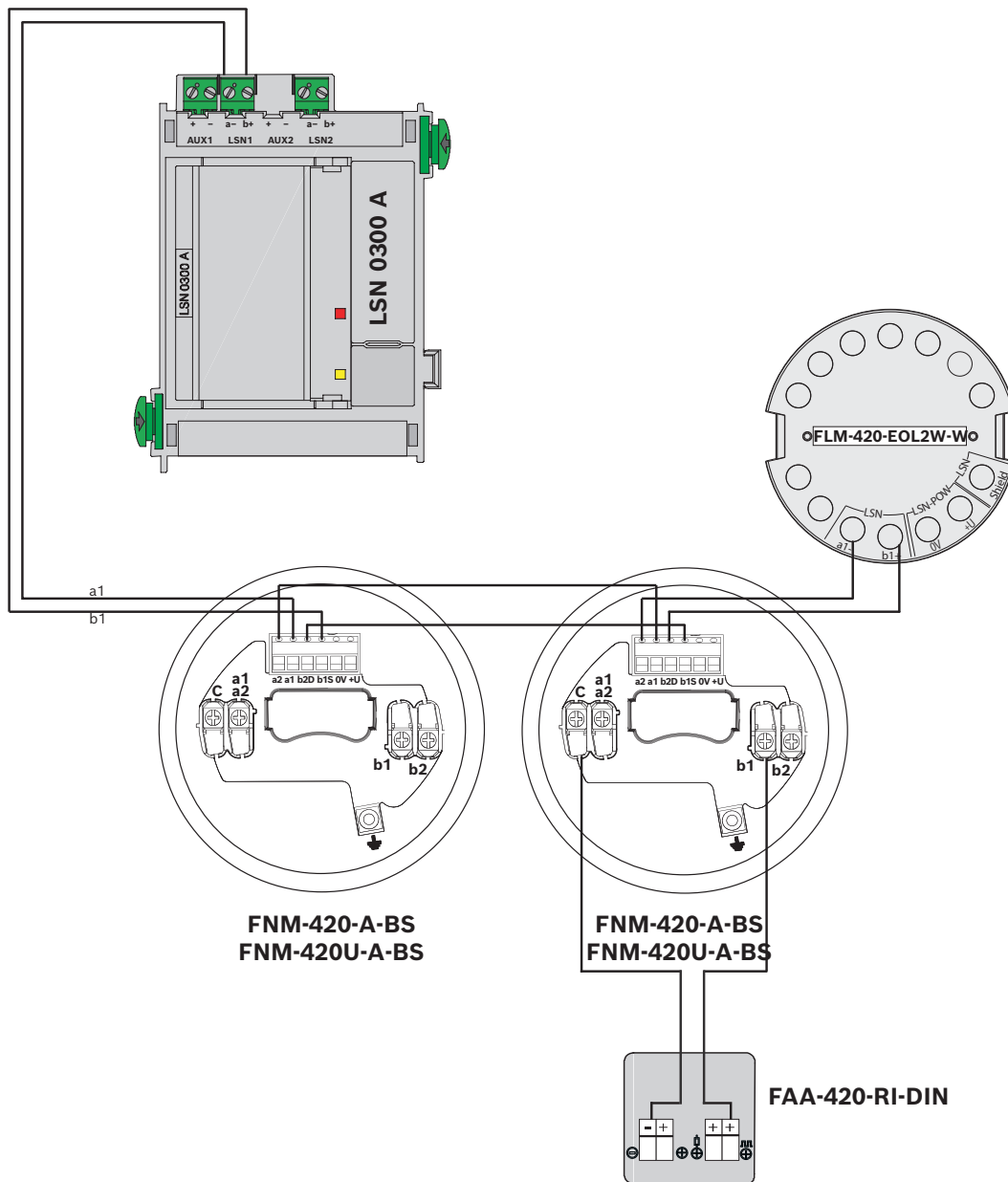





**FNM-420-A-BS**  
**FNM-420U-A-BS**



**ELS**

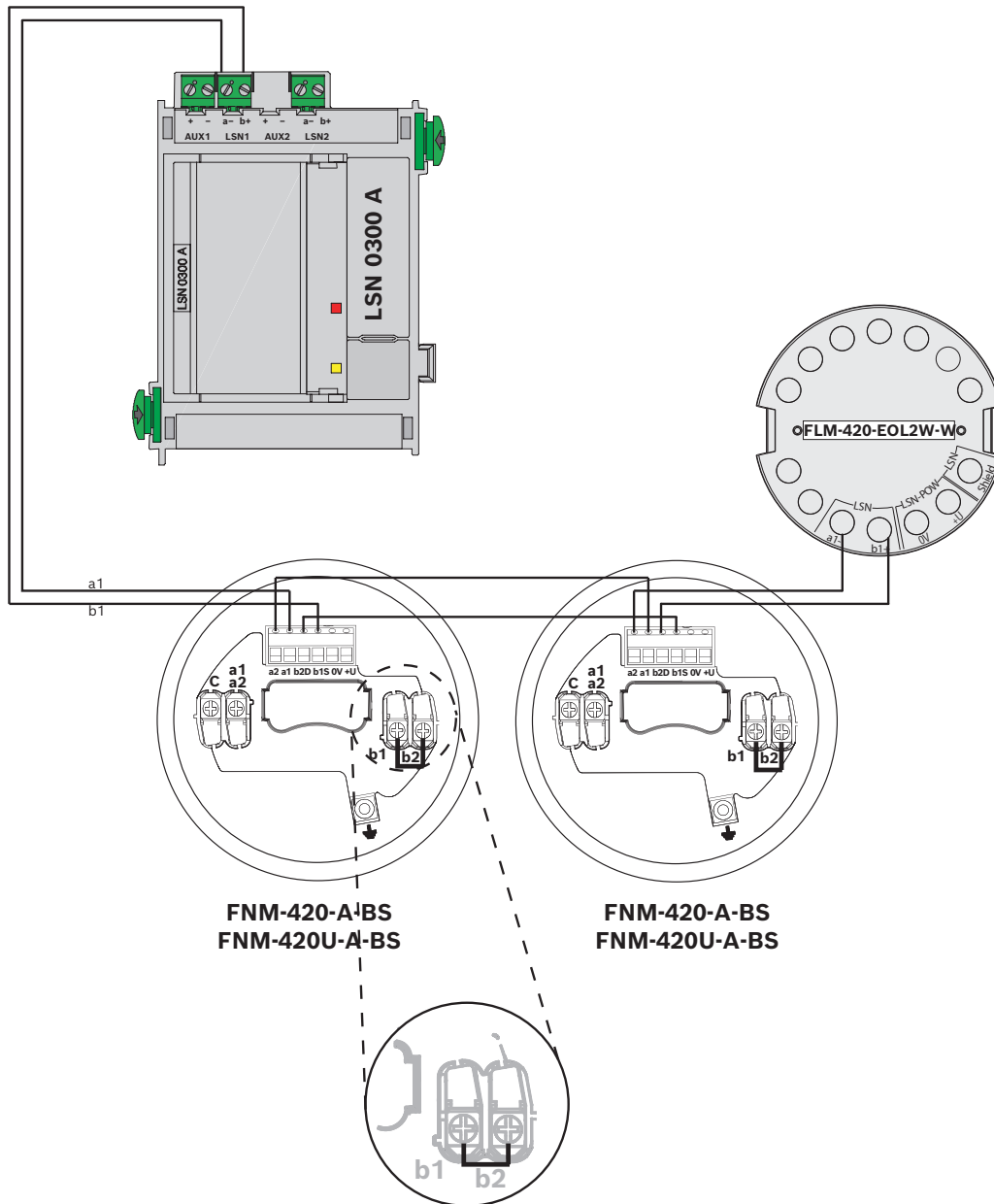

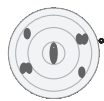

FAP-0520  
FAP-0520-P  
FAP-OC520  
FAP-OC-520-P



ELS

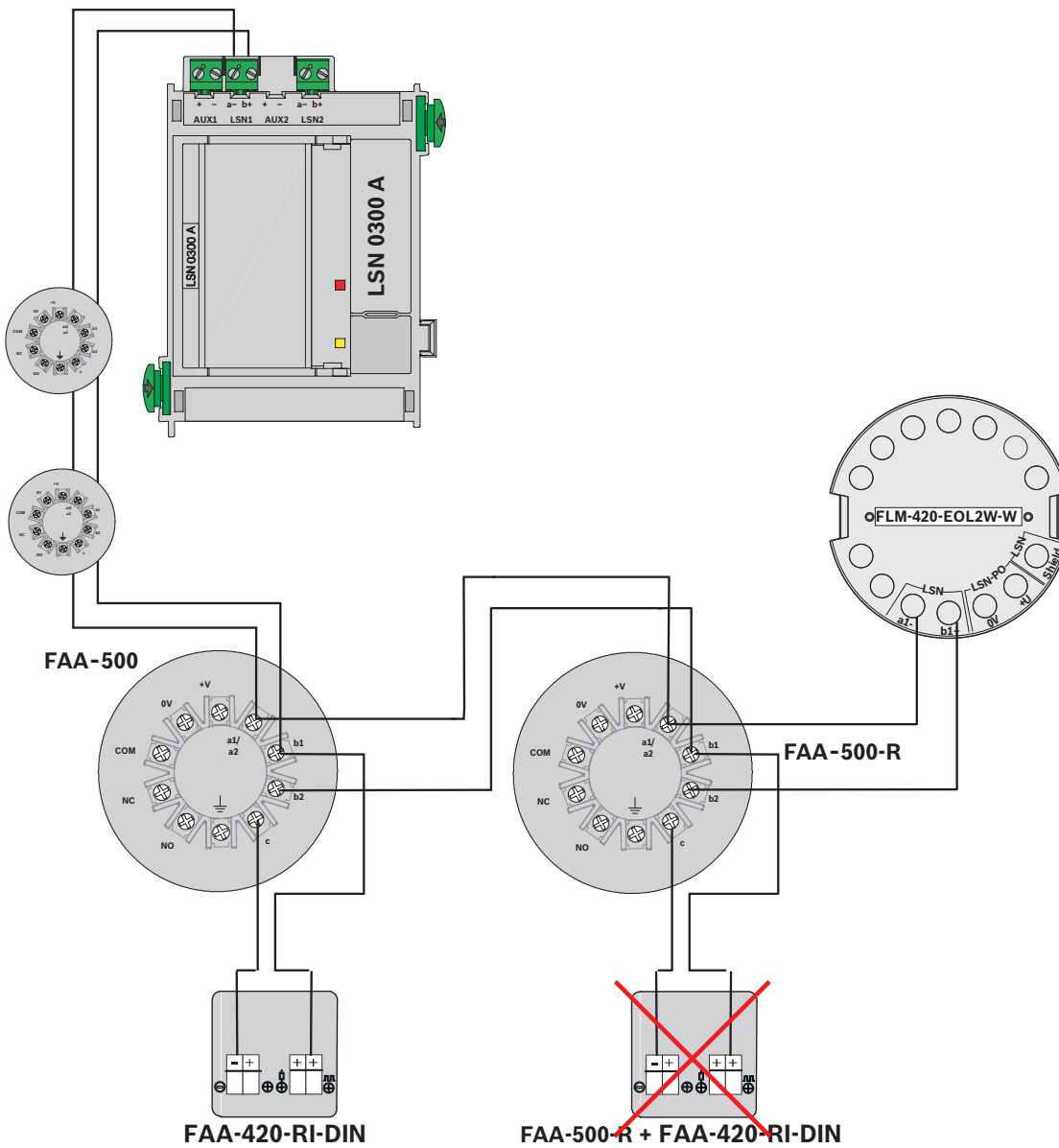

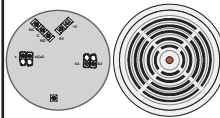

**FAA-MSR-420**  
**FAP-425-O, FAP-425-O-R**  
**FAP-425-OT, FAP-425-OT-R**  
**FAP-425-T-R**  
**FAP-425-DO-R, FAP-425-DOT-R**  
**FAP-425-DOTC-R, FAP-425-DOTCO-R**

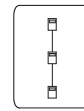

**ELS**

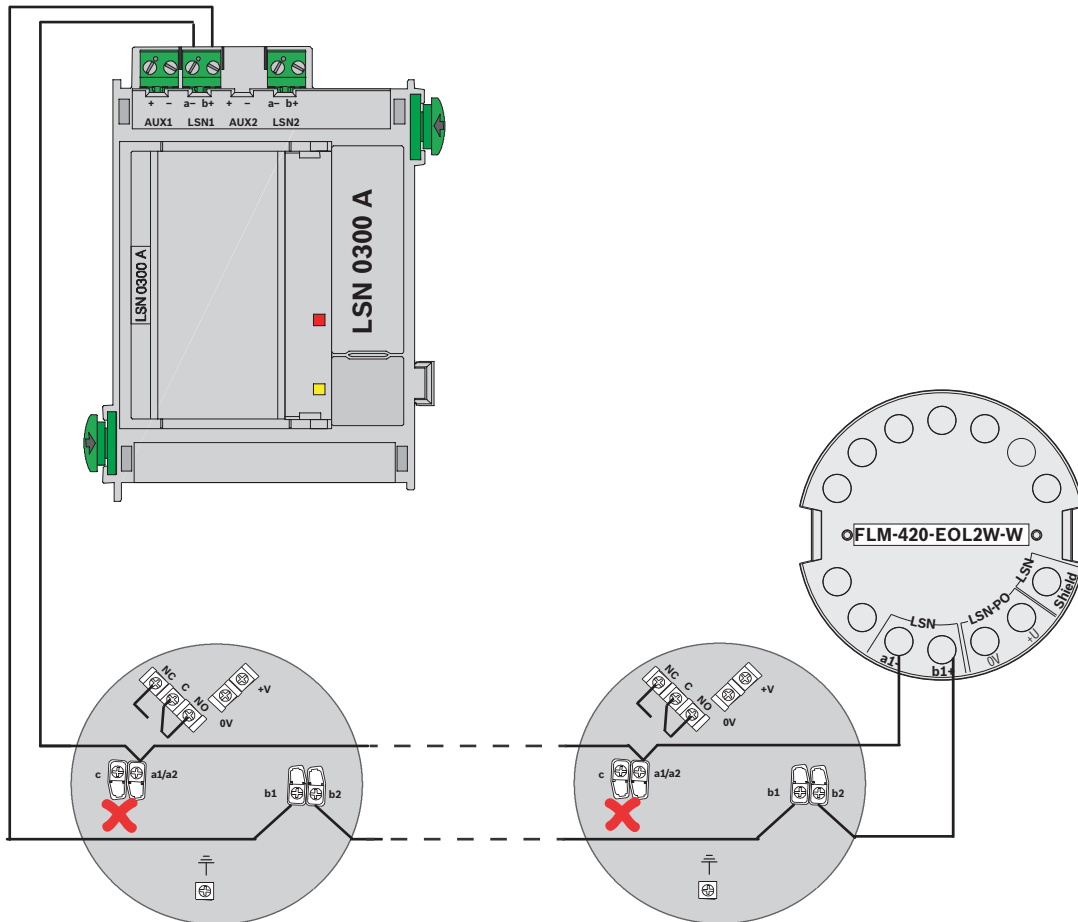

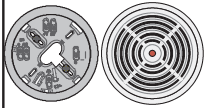

MS 400, MS 400 B  
 FAP-425-O, FAP-425-O-R  
 FAP-425-OT, FAP-425-OT-R  
 FAP-425-T-R  
 FAP-425-DO-R, FAP-425-DOT-R  
 FAP-425-DOTC-R, FAP-425-DOTCO-R



ELS

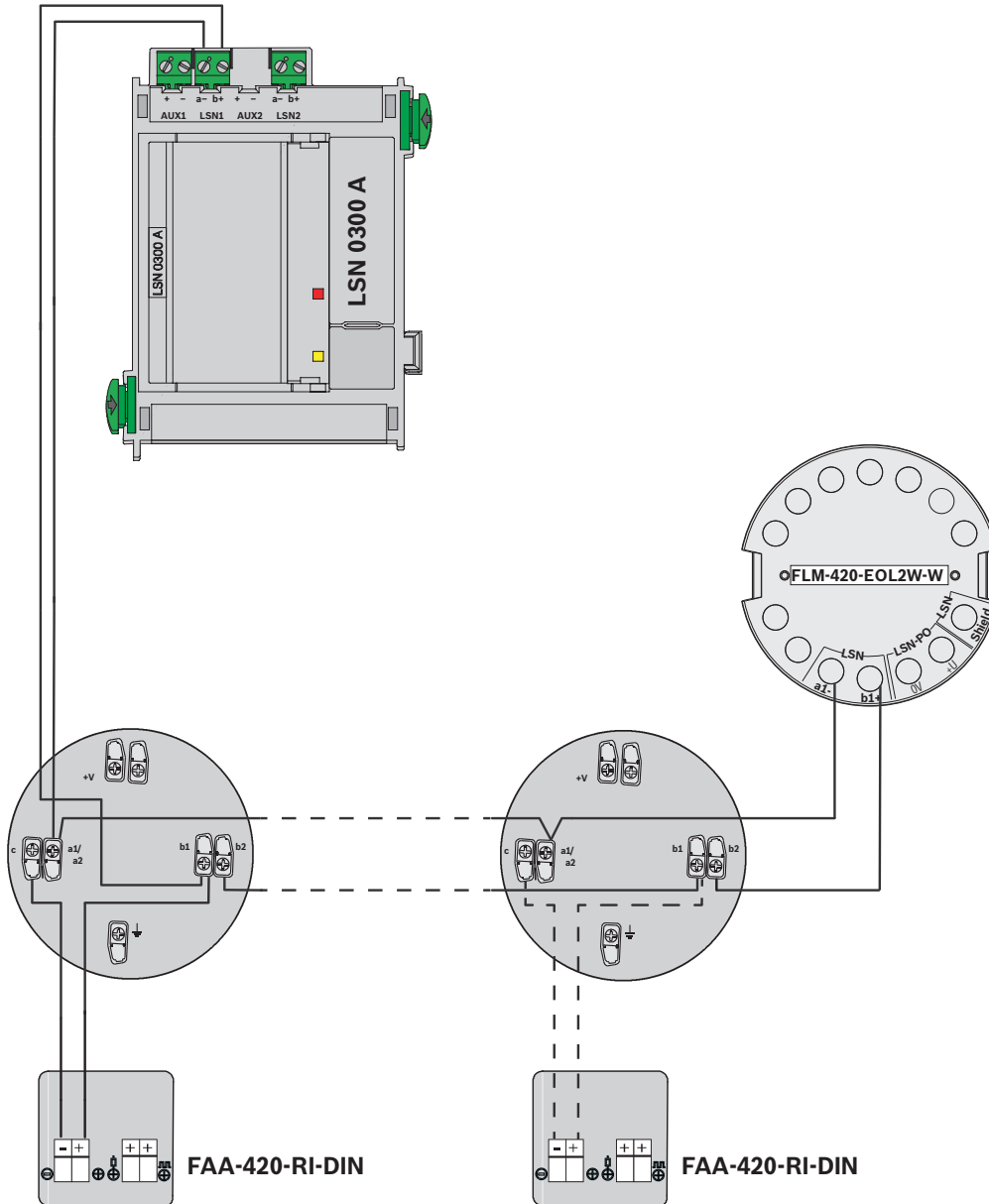

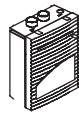

FAS-420 Series

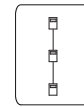

ELS

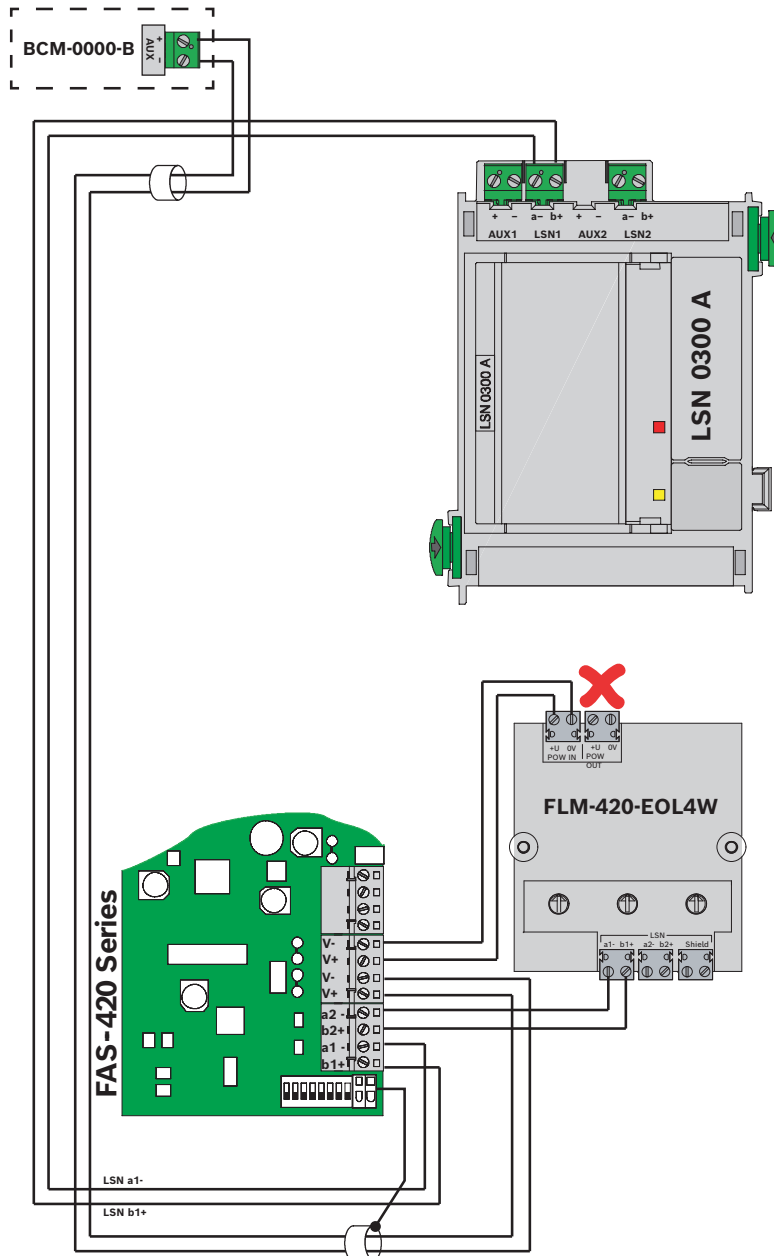

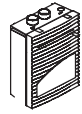

FAS-420 Series

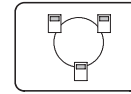

ELS

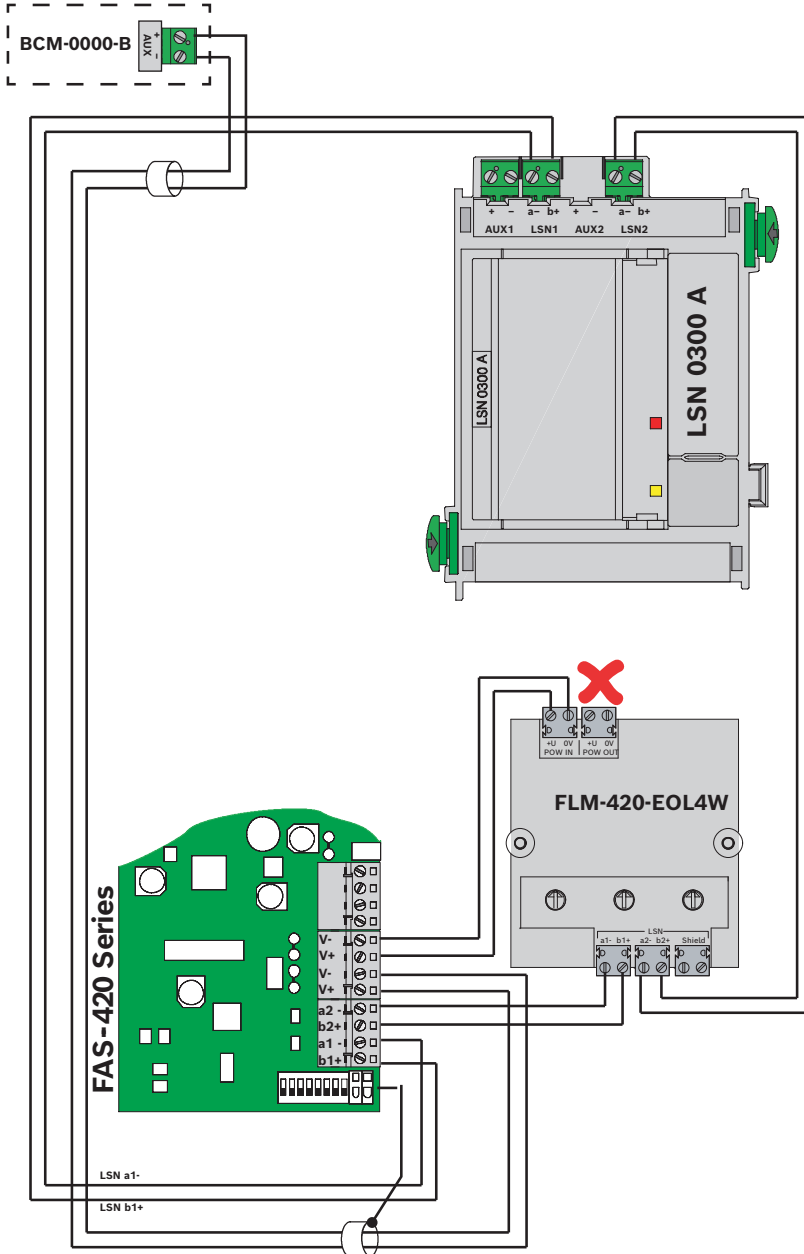

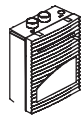

FAS-420-TM Series

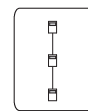

ELS

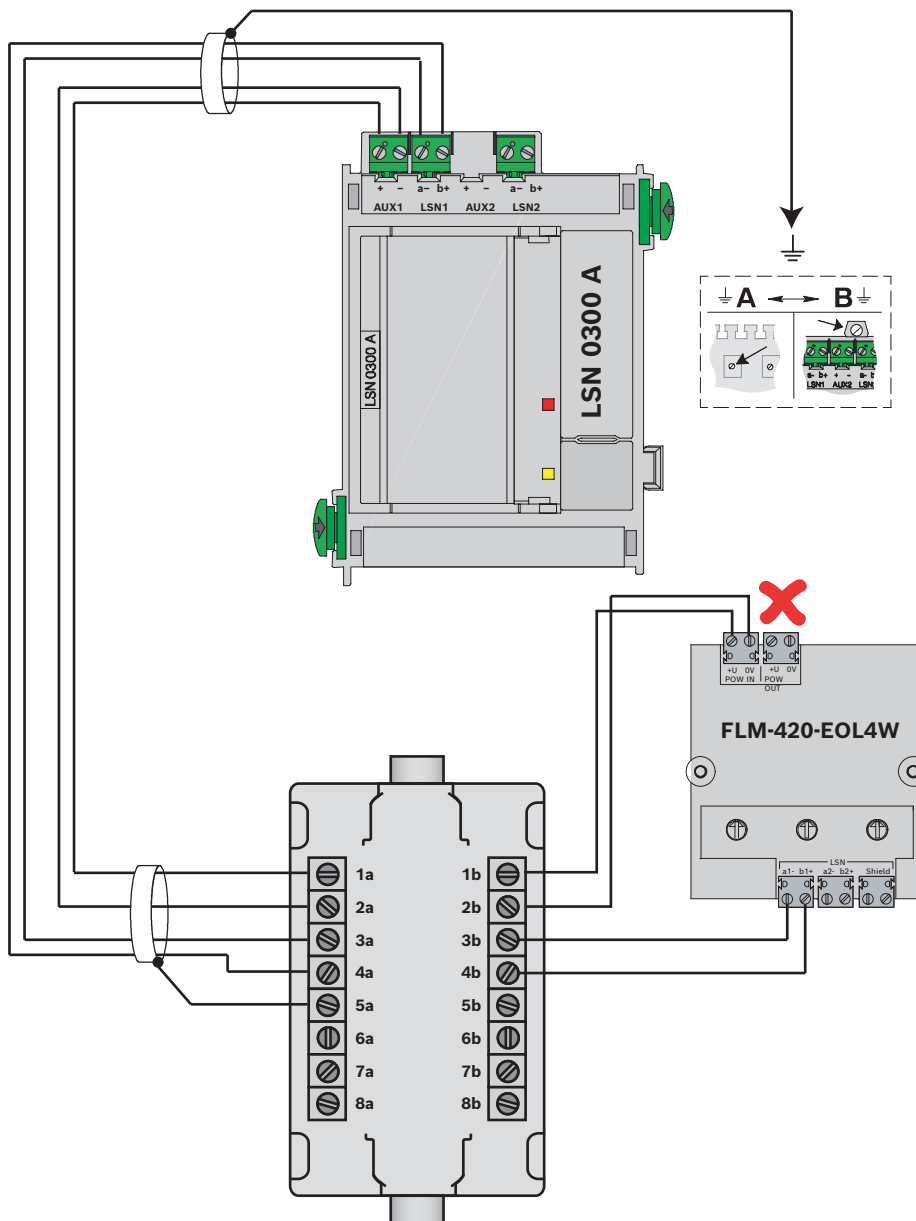

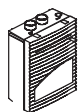

FAS-420-TM Series

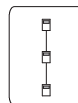

ELS

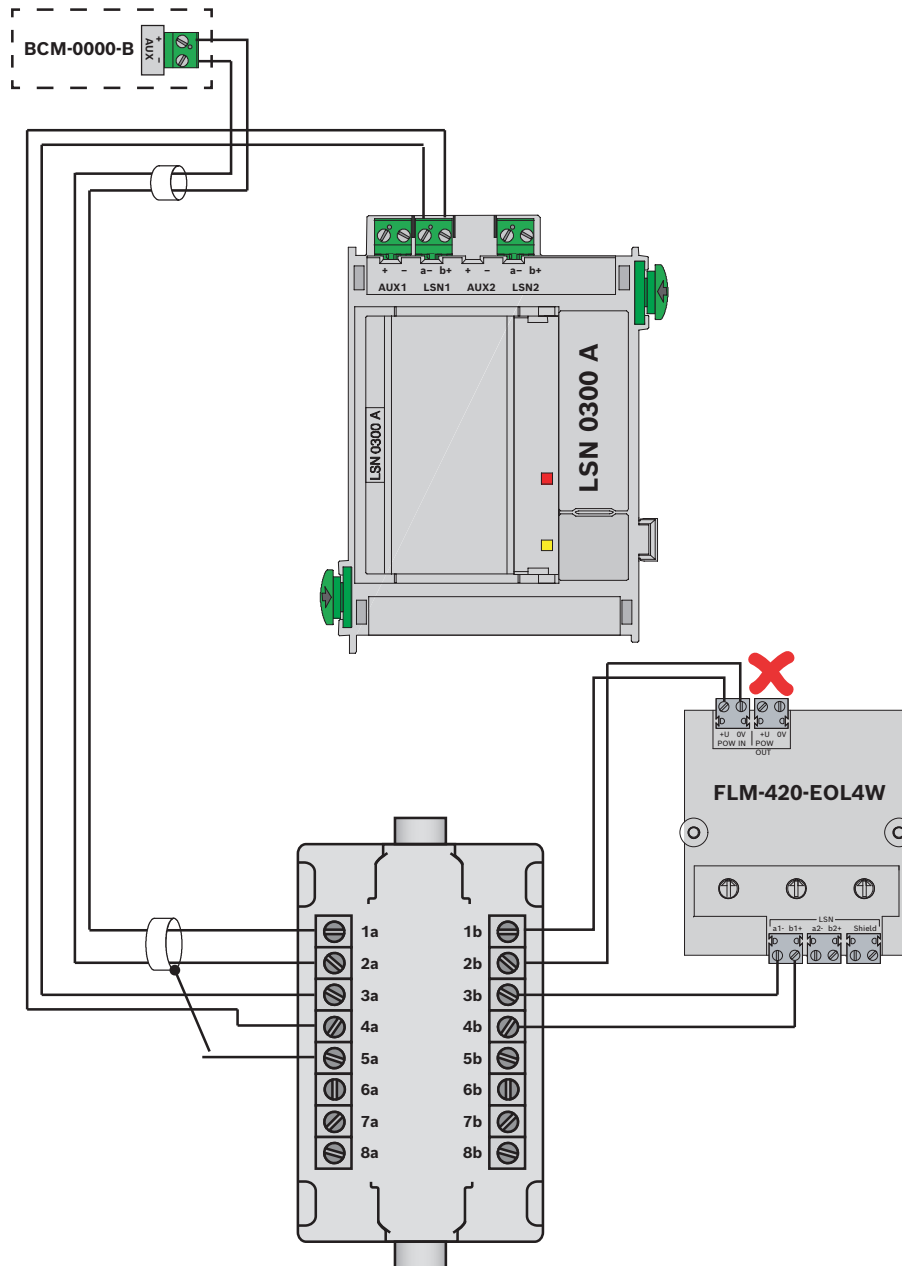



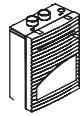

FAS-420-TM Series

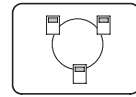

ELS

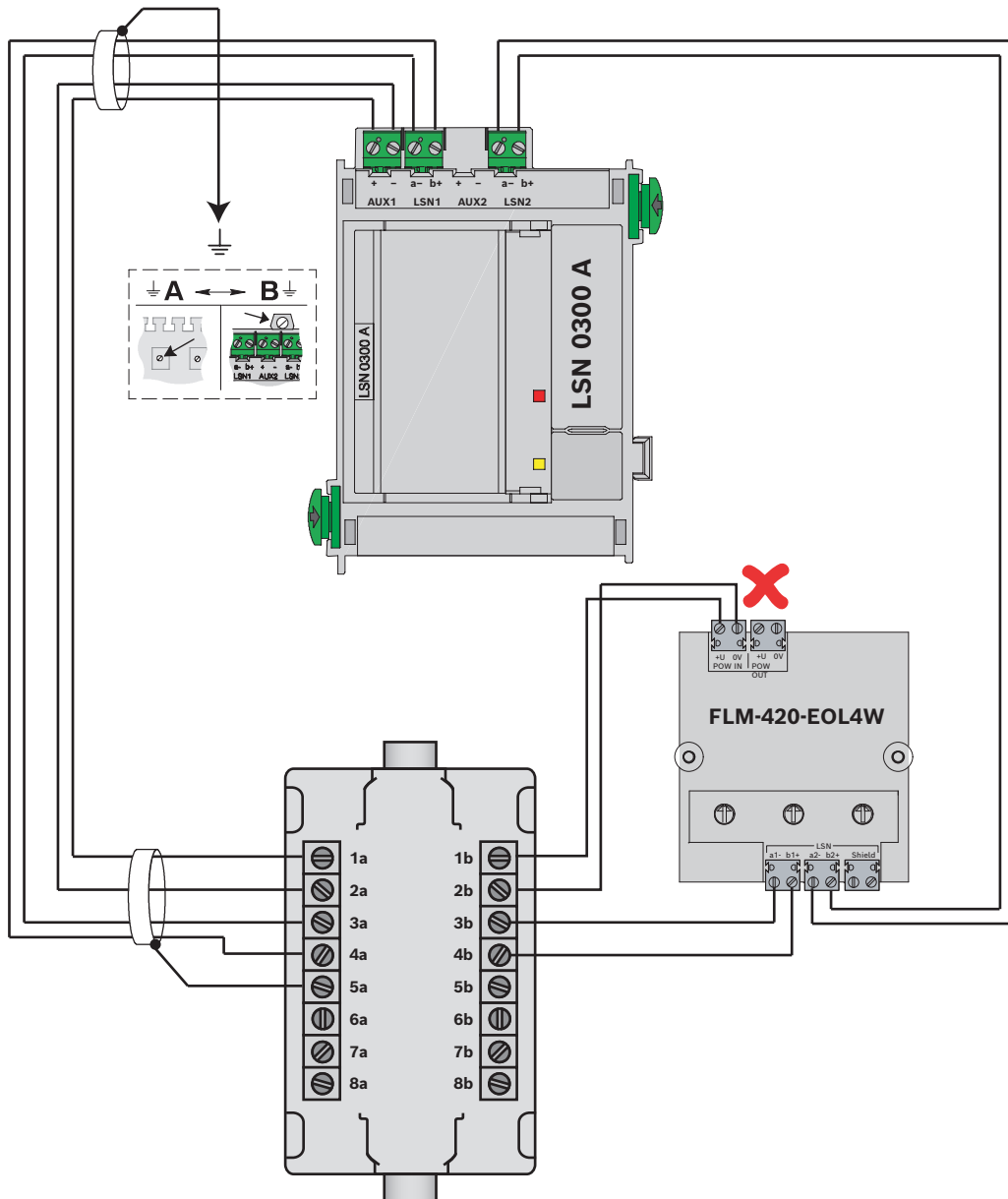

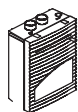

FAS-420-TM Series

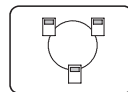

ELS

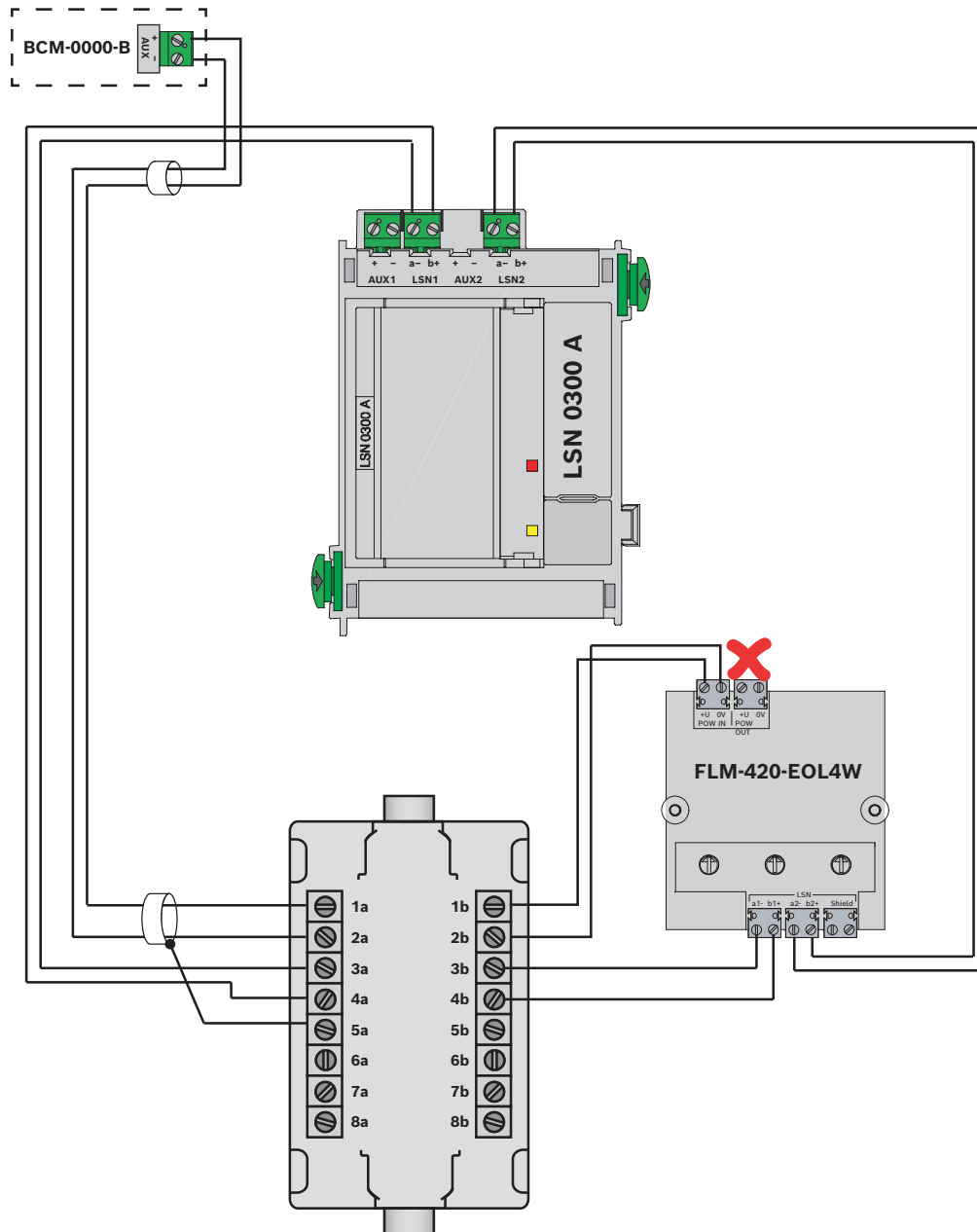



**FBW 100 LSN**

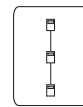

**ELS**

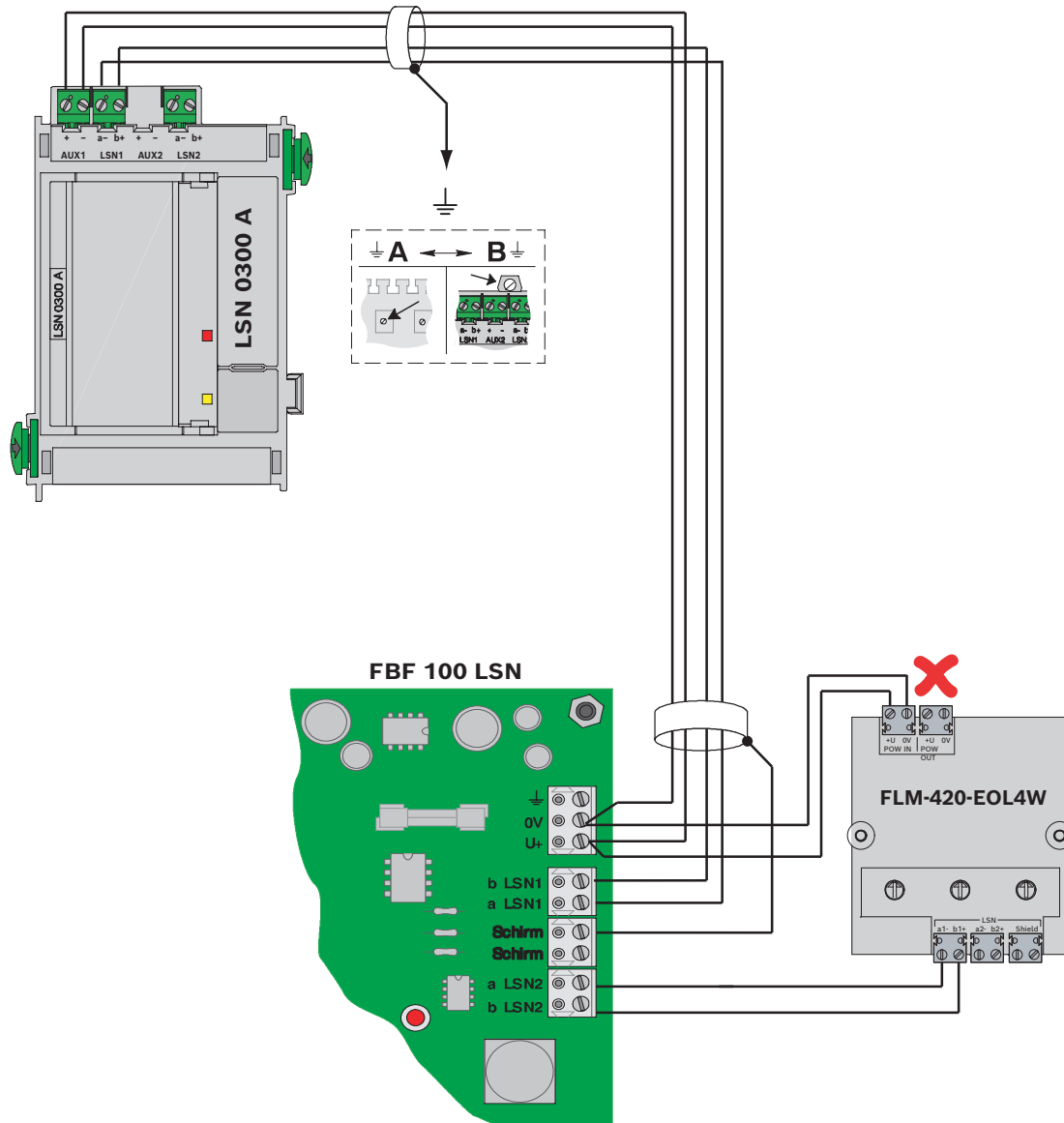



FBF 100 LSN

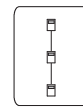

ELS

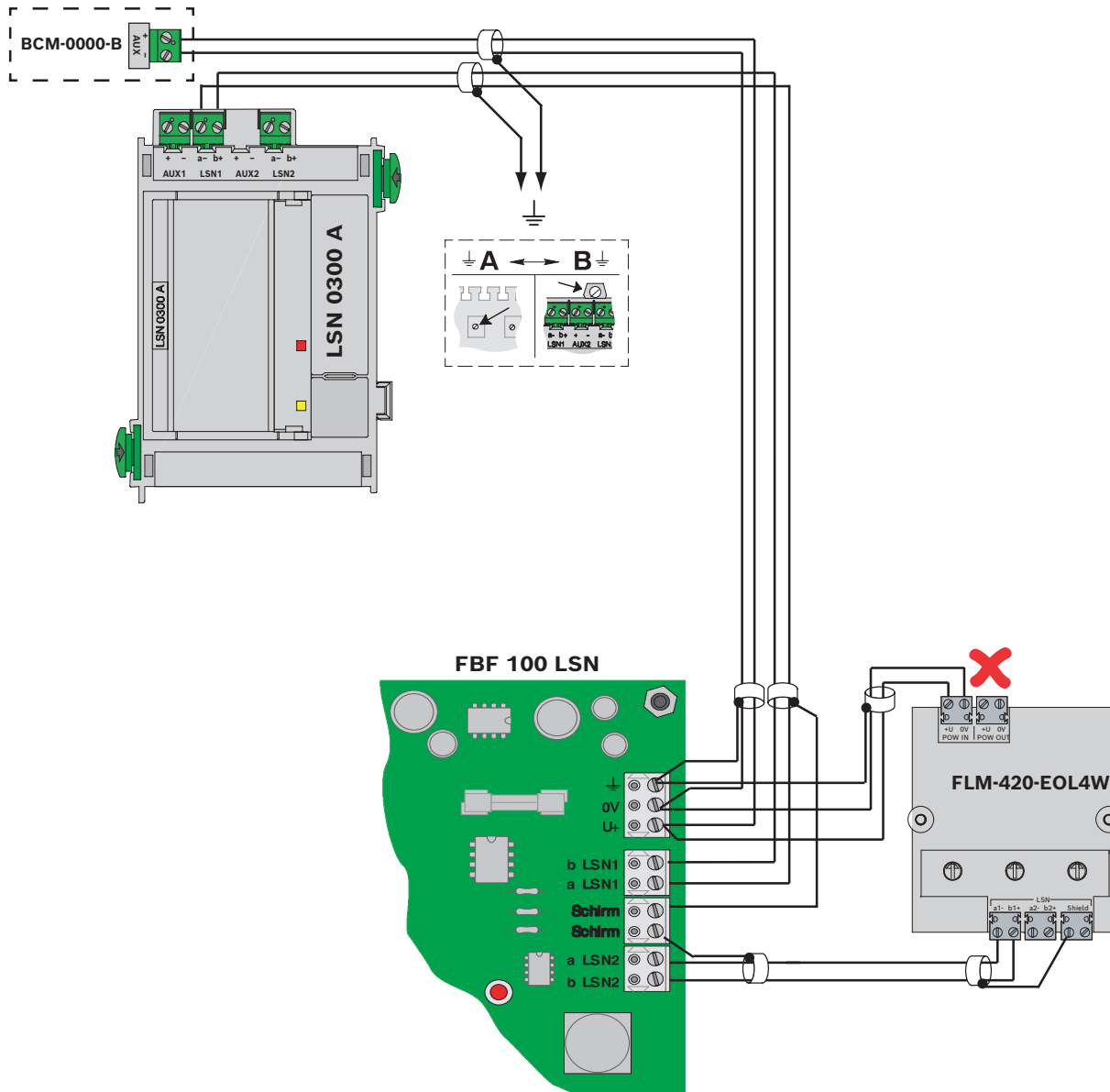



**FBF 100 LSN**

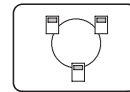

**ELS**

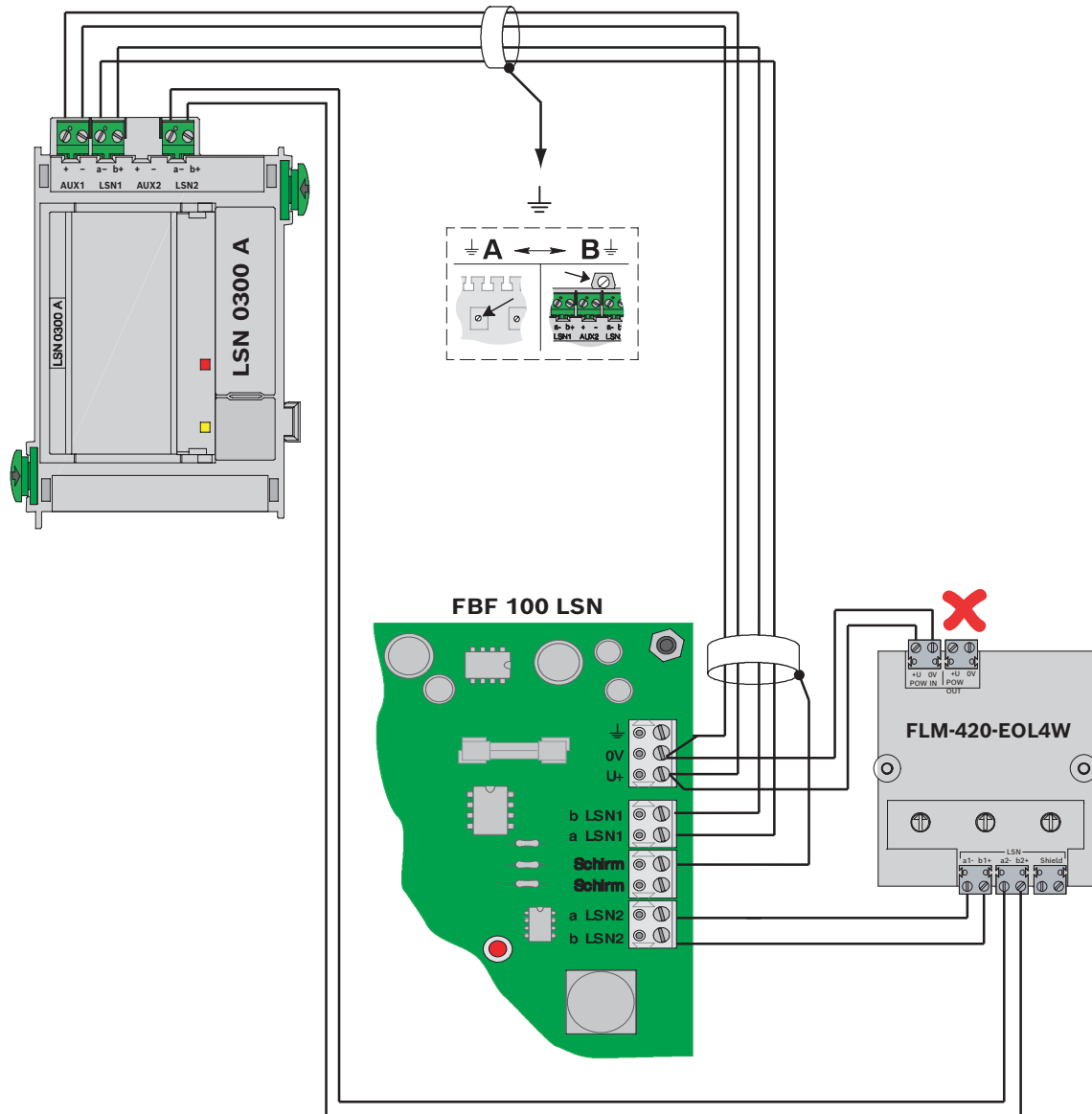



**FBF 100 LSN**

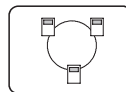

**ELS**

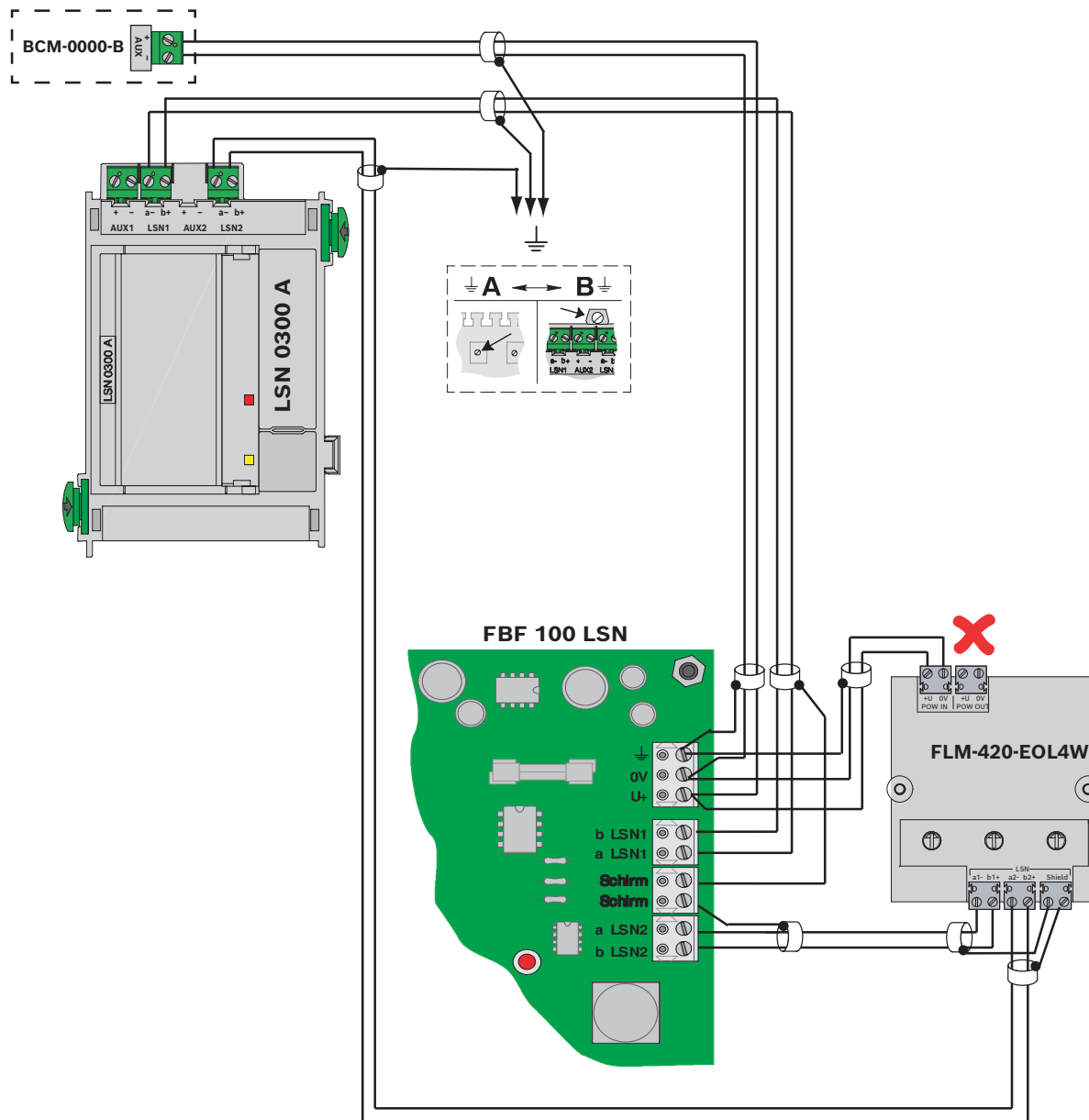

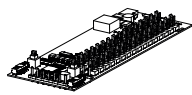

ATB 420 LSNi

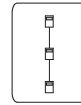

ELS

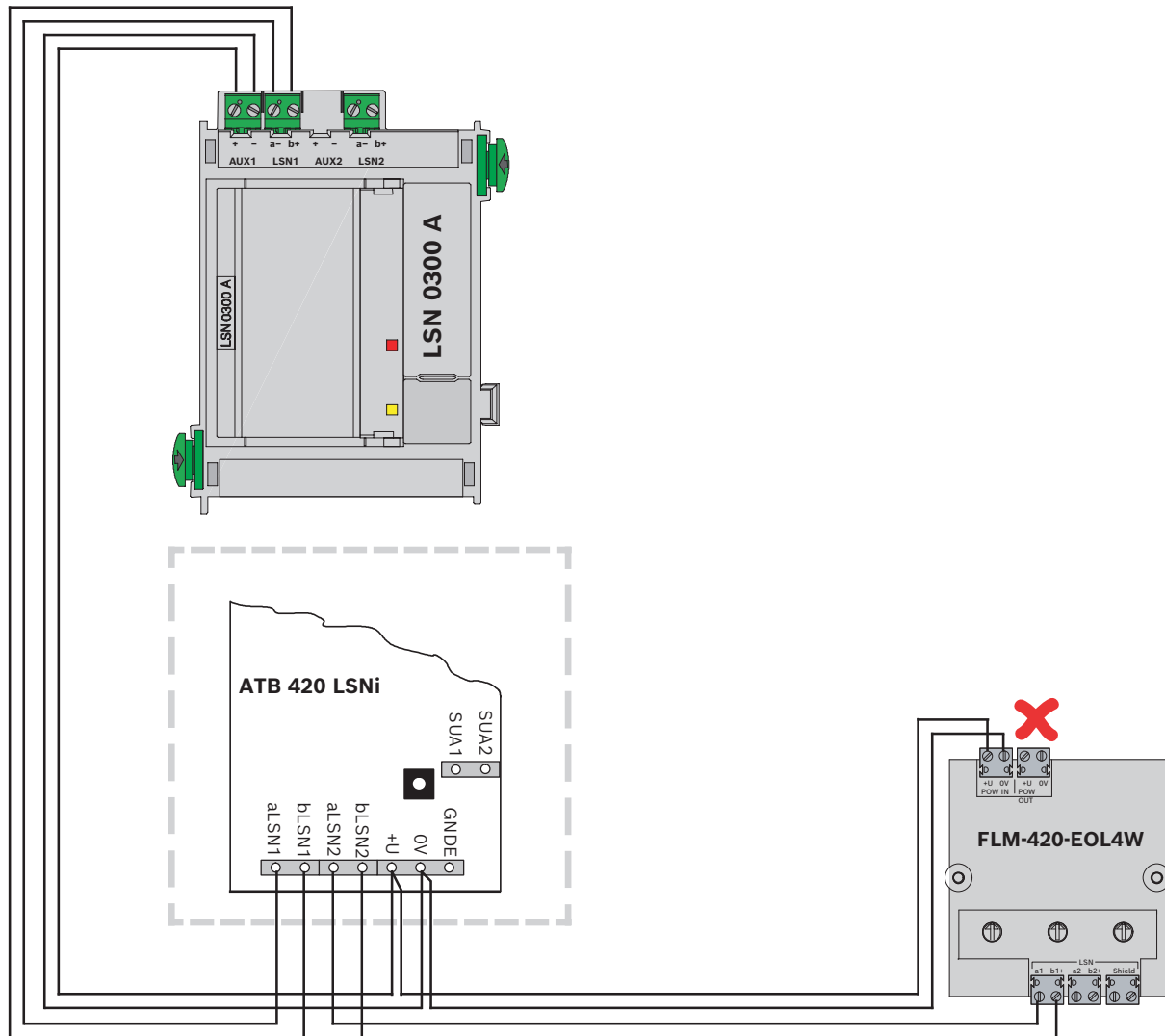

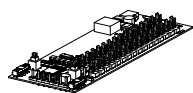

ATB 420 LSNi

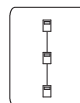

ELS

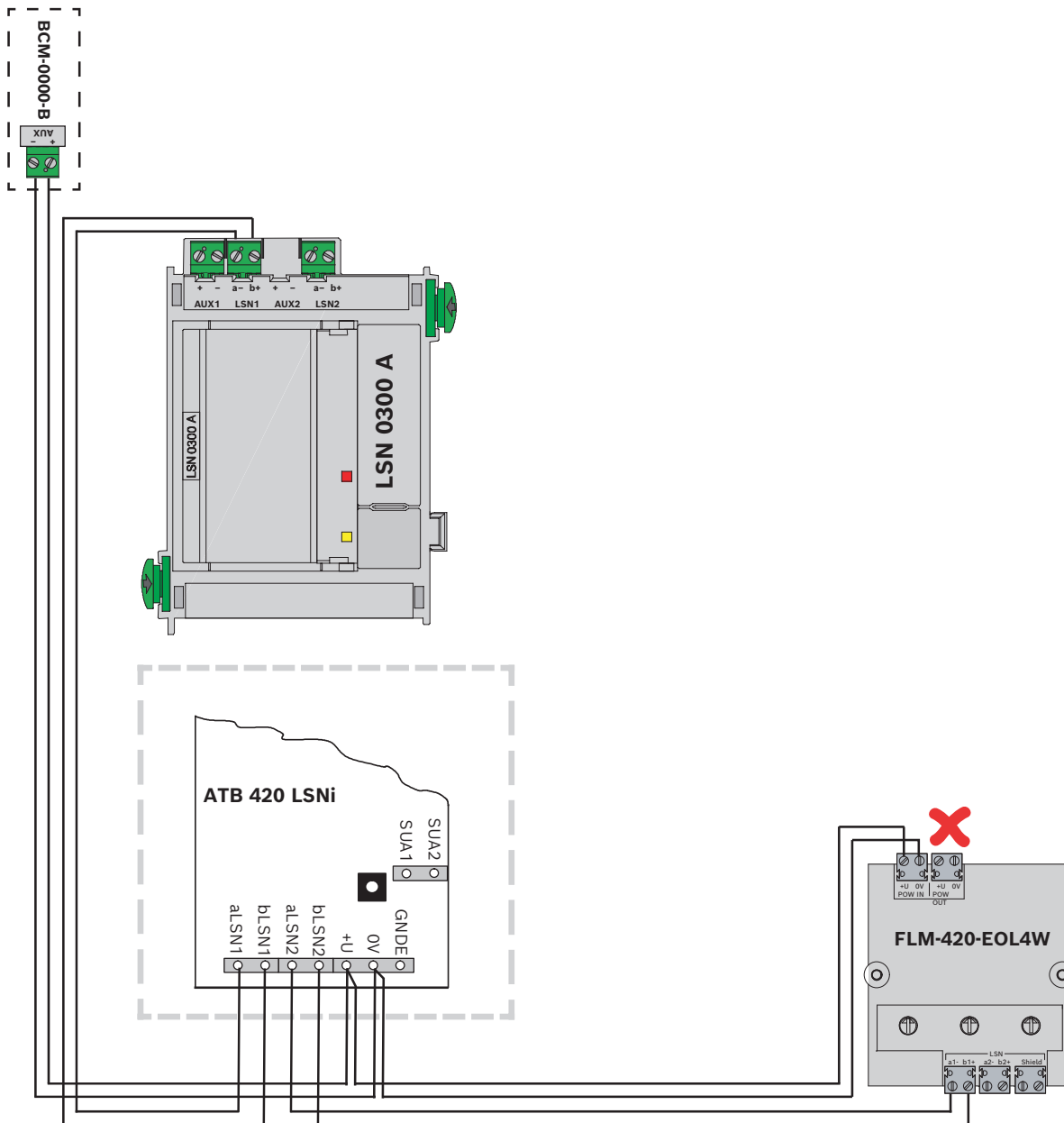



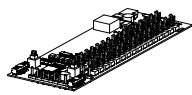

ATB 420 LSNi

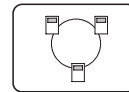

ELS

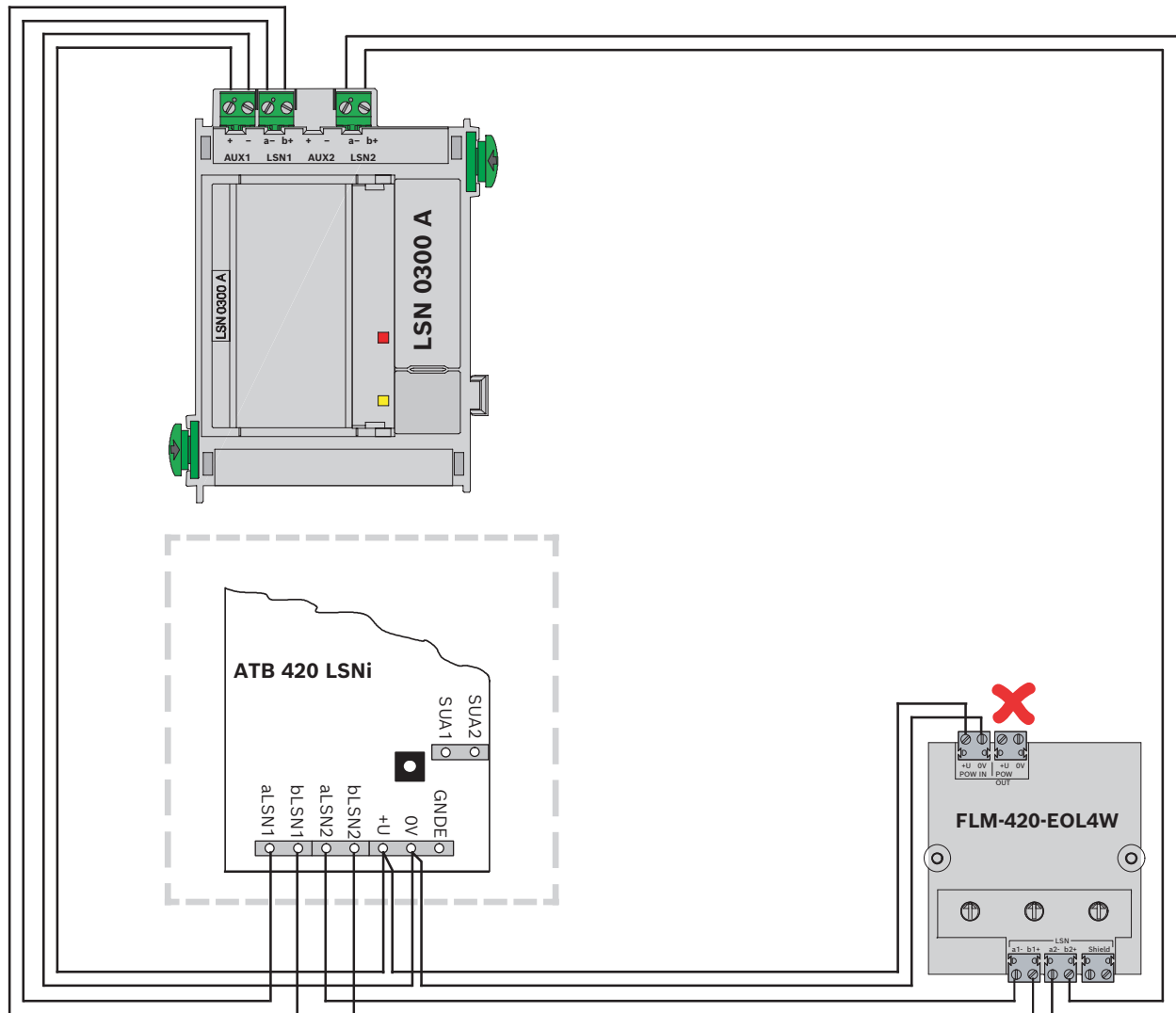

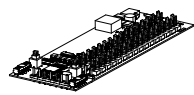

ATB 420 LSNi

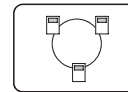

ELS

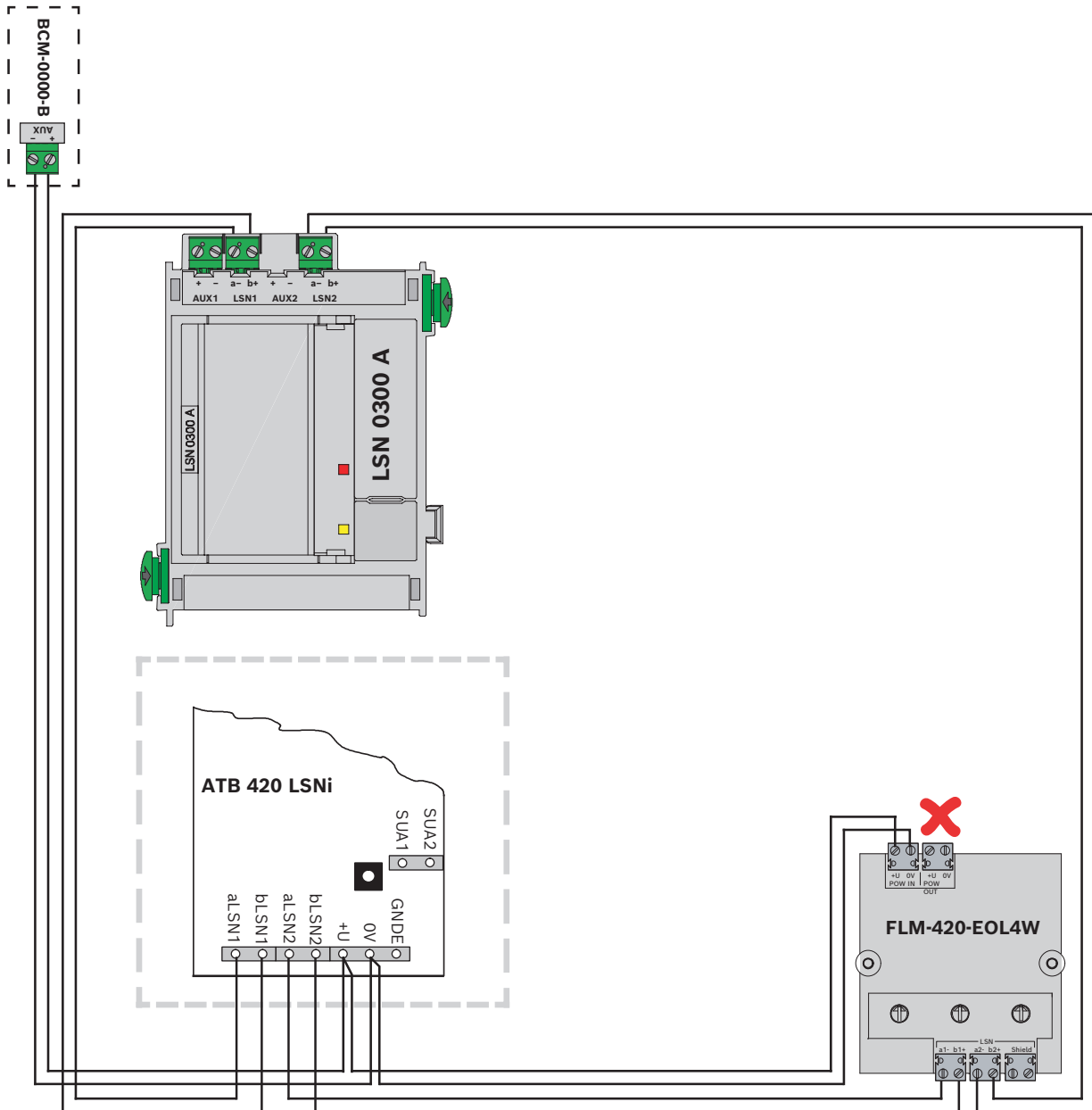



**BAT 100 LSN  
ATG 420 LSNi**

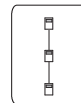

**ELS**

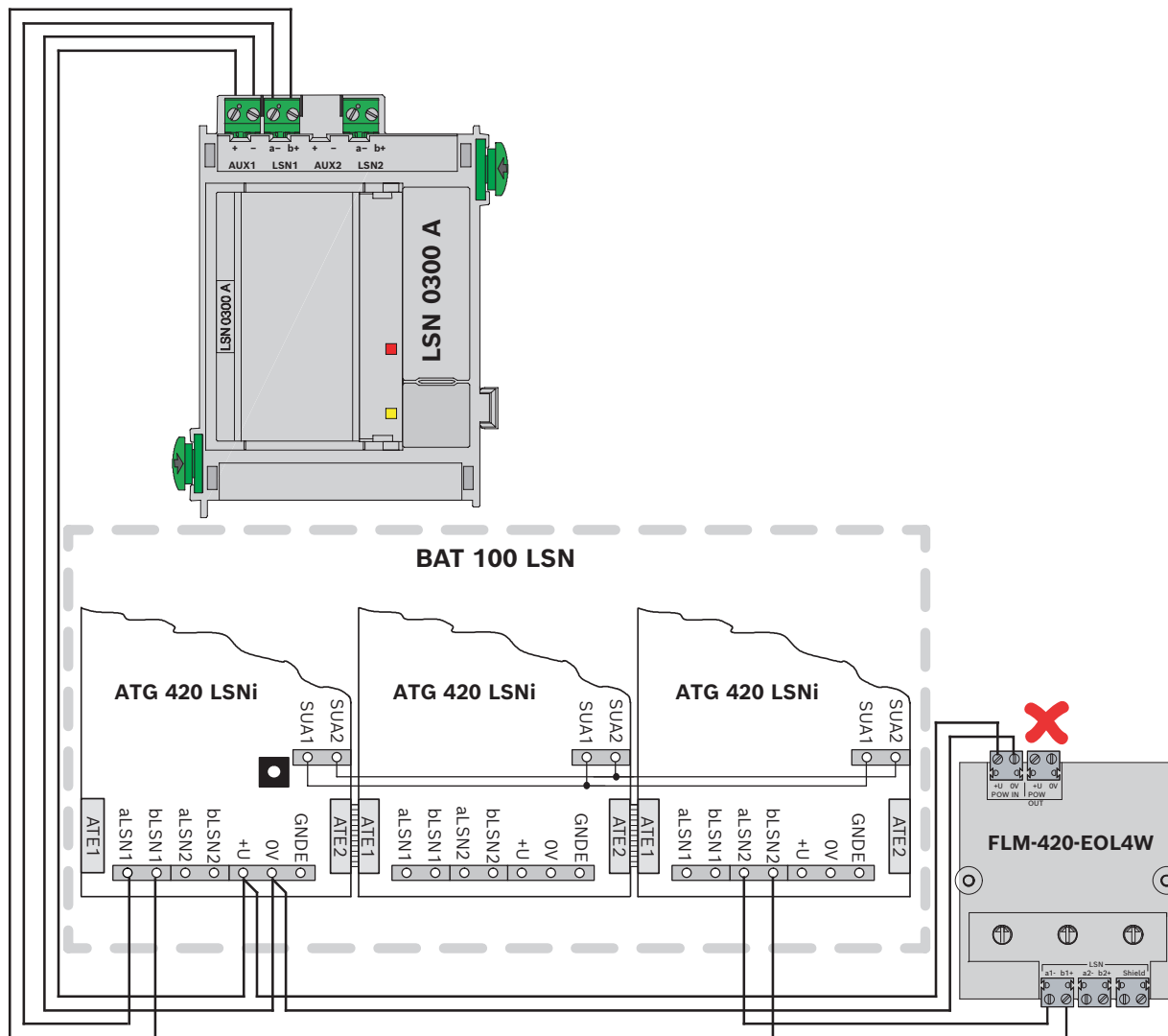



**BAT 100 LSN**  
**ATG 420 LSNi**

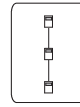

**ELS**

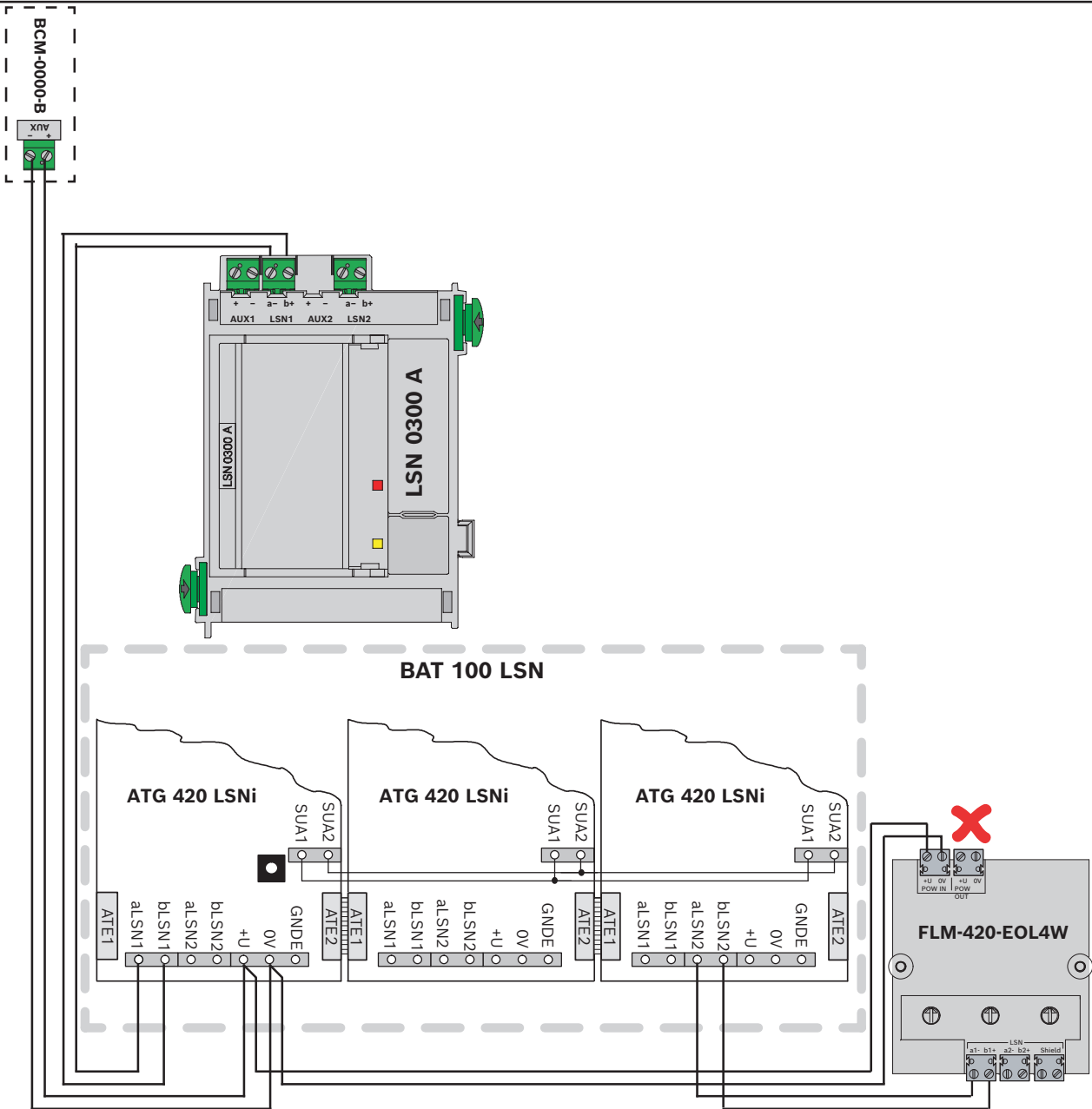



**BAT 100 LSN  
ATG 420 LSNi**

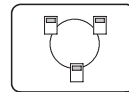

**ELS**

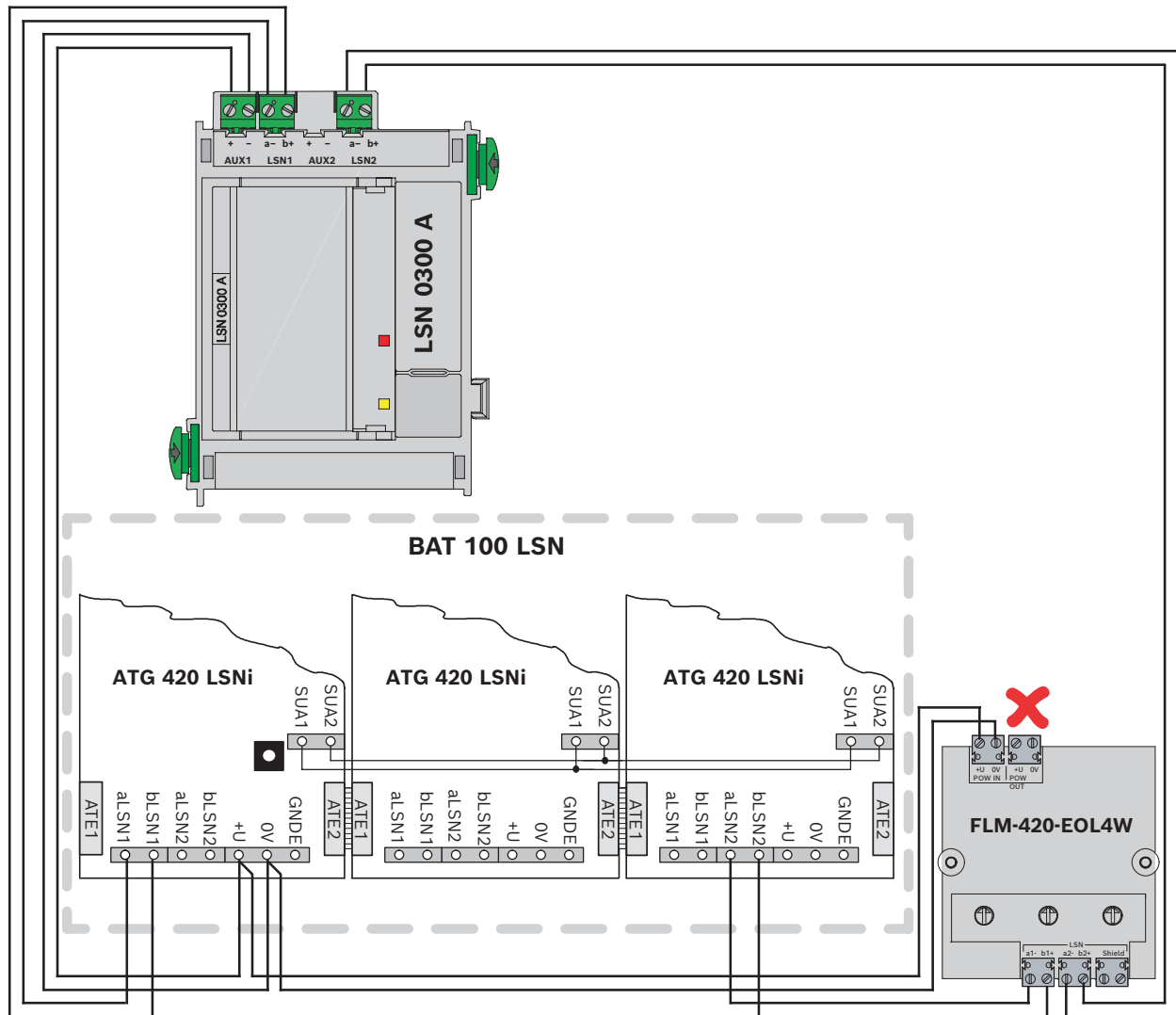



**BAT 100 LSN**  
**ATG 420 LSNi**

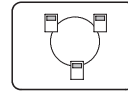

**ELS**

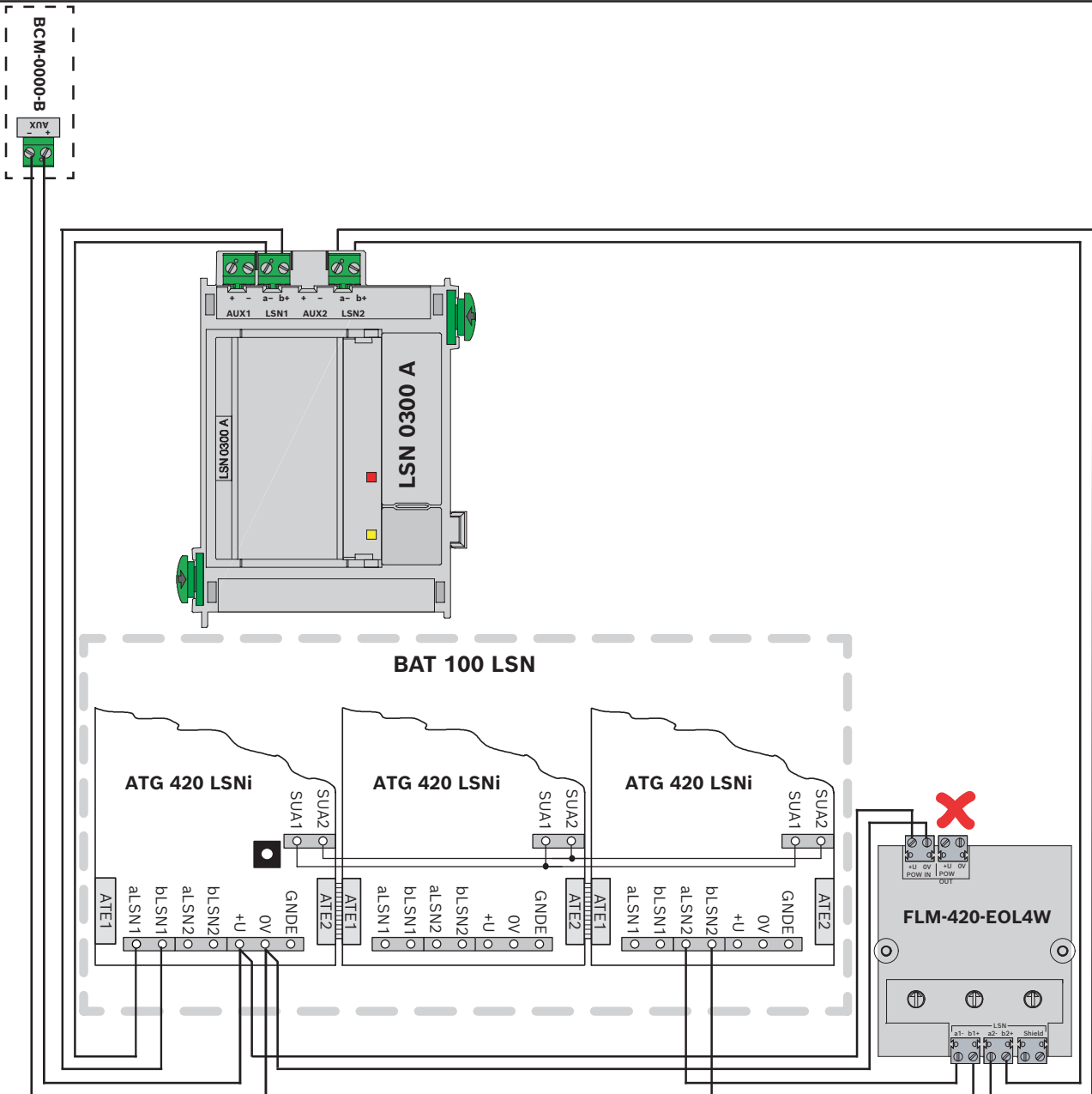



**FNX-425U-WFWH**  
**FNX-425U-RFWH**  
**FNX-425U-WFRD**  
**FNX-425U-RFRD**



**ELS**

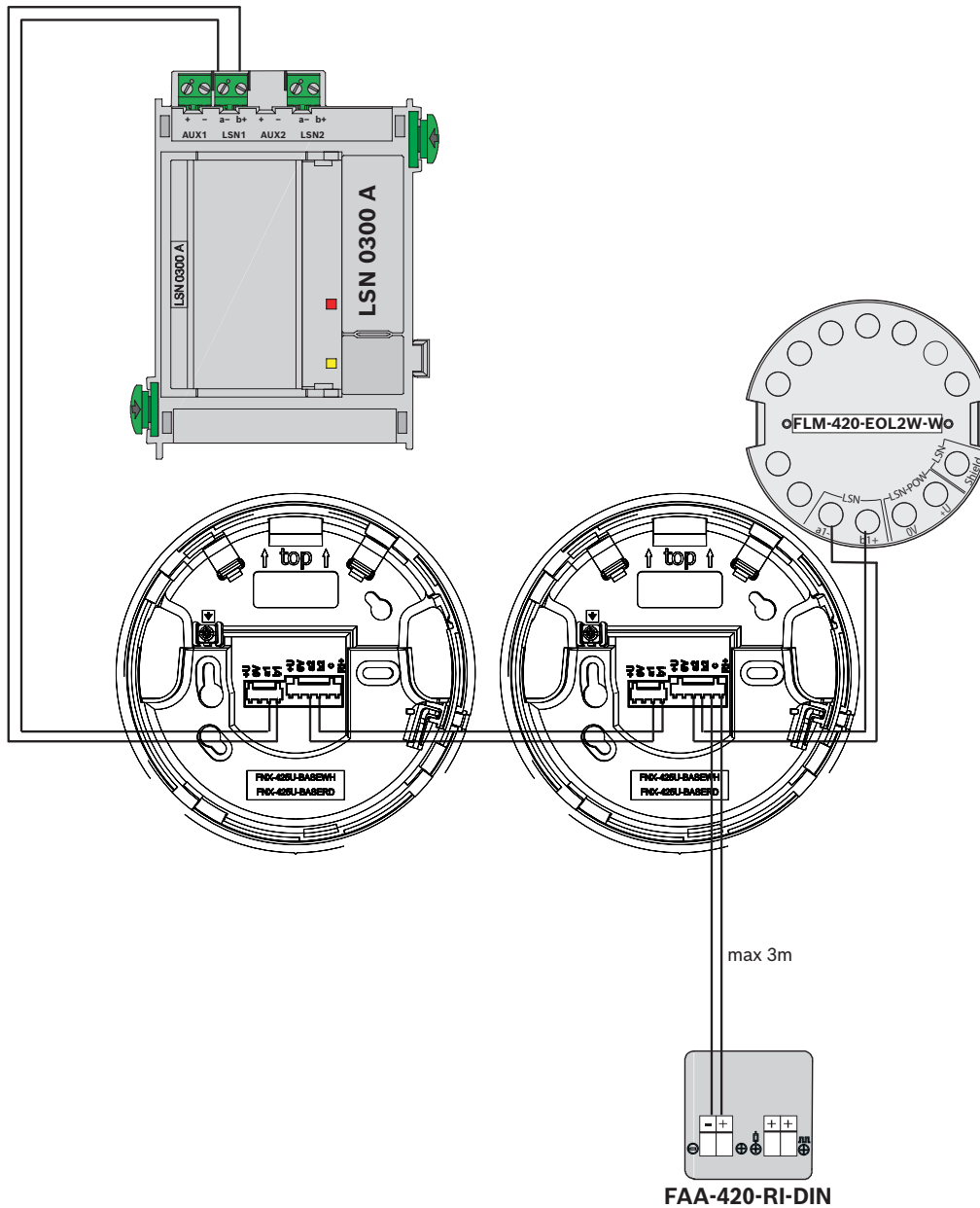



FNX-425U-WFWH  
 FNX-425U-RFWH  
 FNX-425U-WFRD  
 FNX-425U-RFRD

+

FNX-425U-COVWH  
 FNX-425U-COVRD



ELS

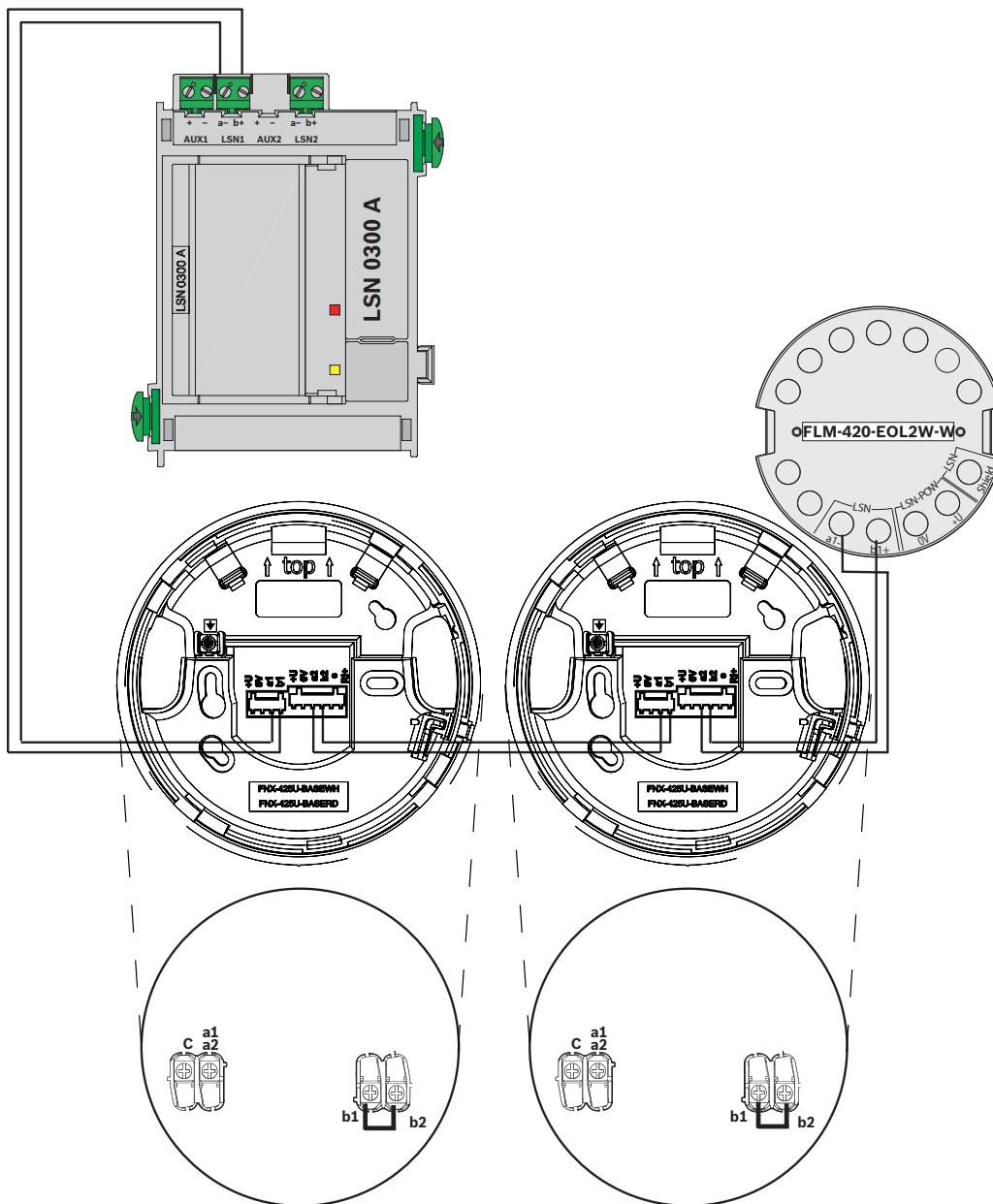



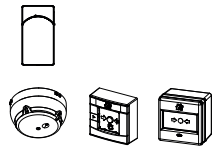

**FWI-270**

**FDOOT271-O**  
**FDM275-O**  
**FDM273-O**

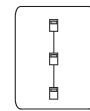

**ELS**

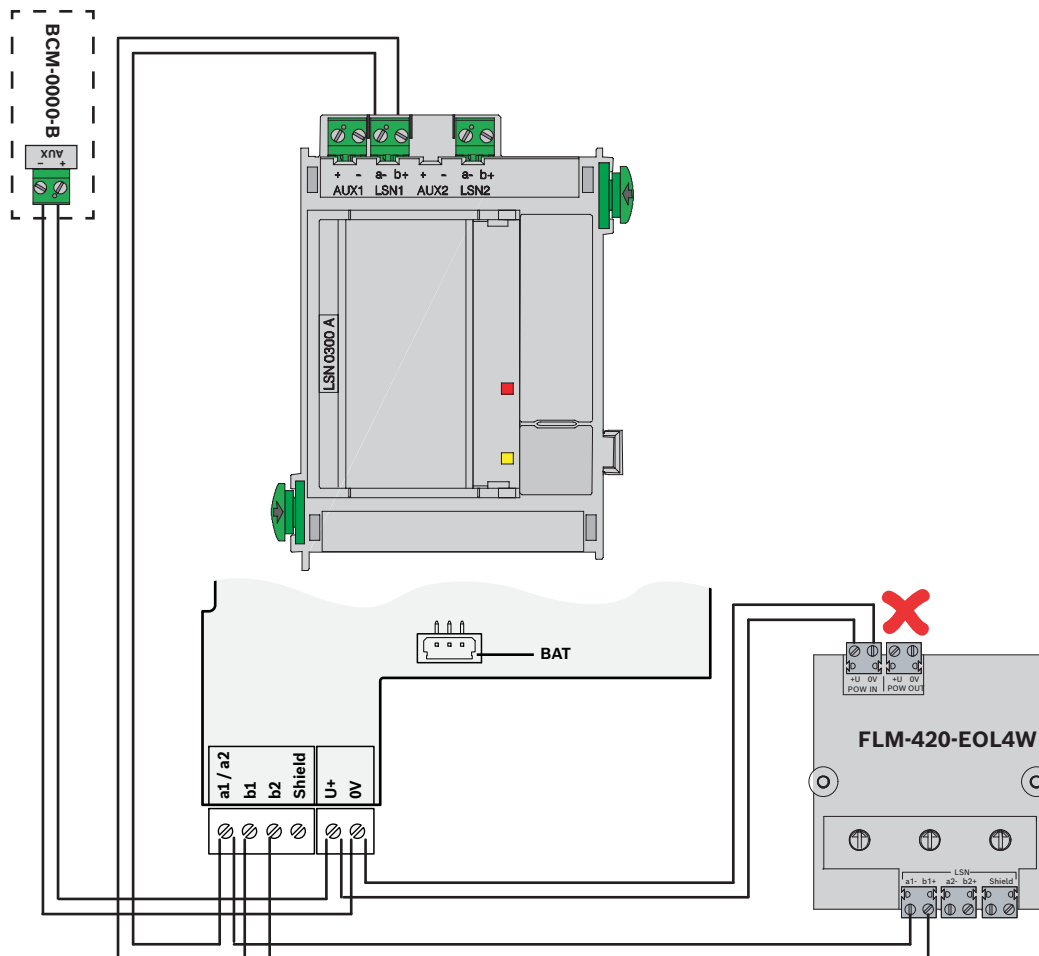



**FWI-270**

**FDOOT271-O**  
**FDM275-O**  
**FDM273-O**

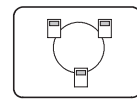

**ELS**

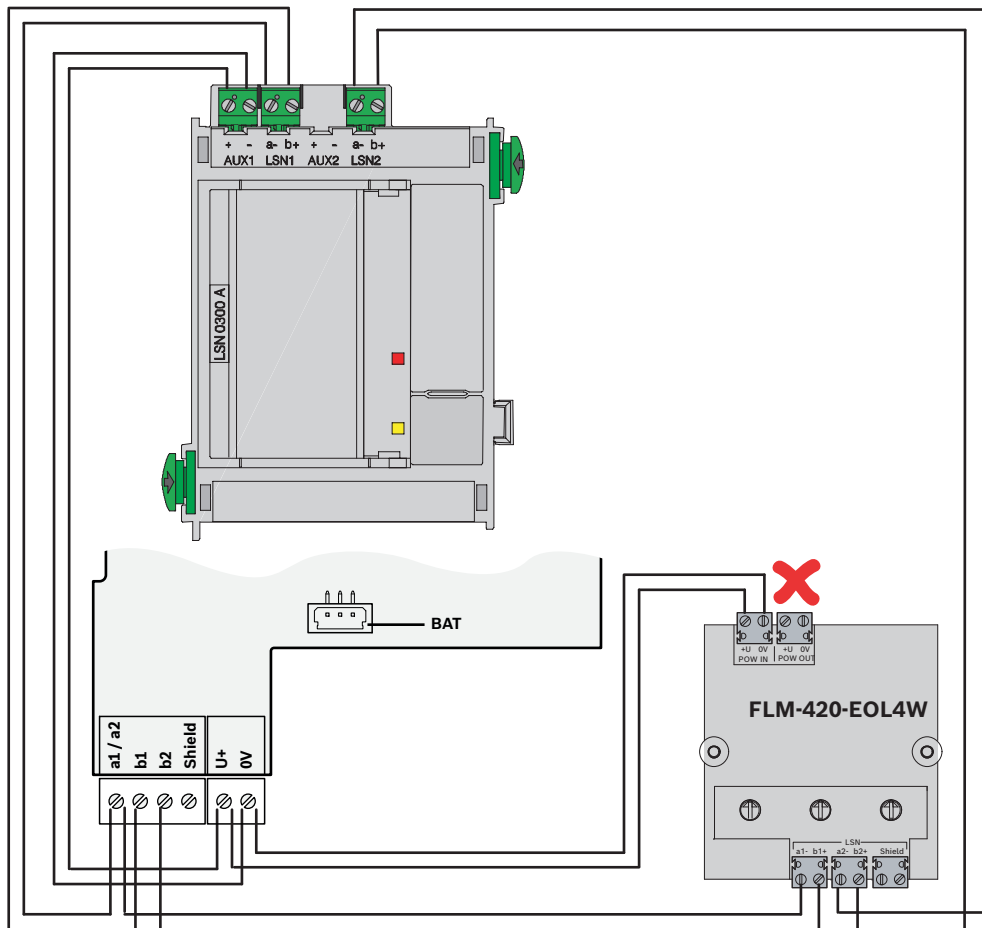

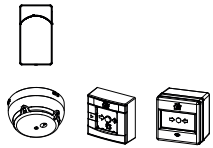

**FWI-270**

**FDOOT271-O**  
**FDM275-O**  
**FDM273-O**

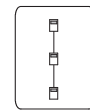

**ELS**

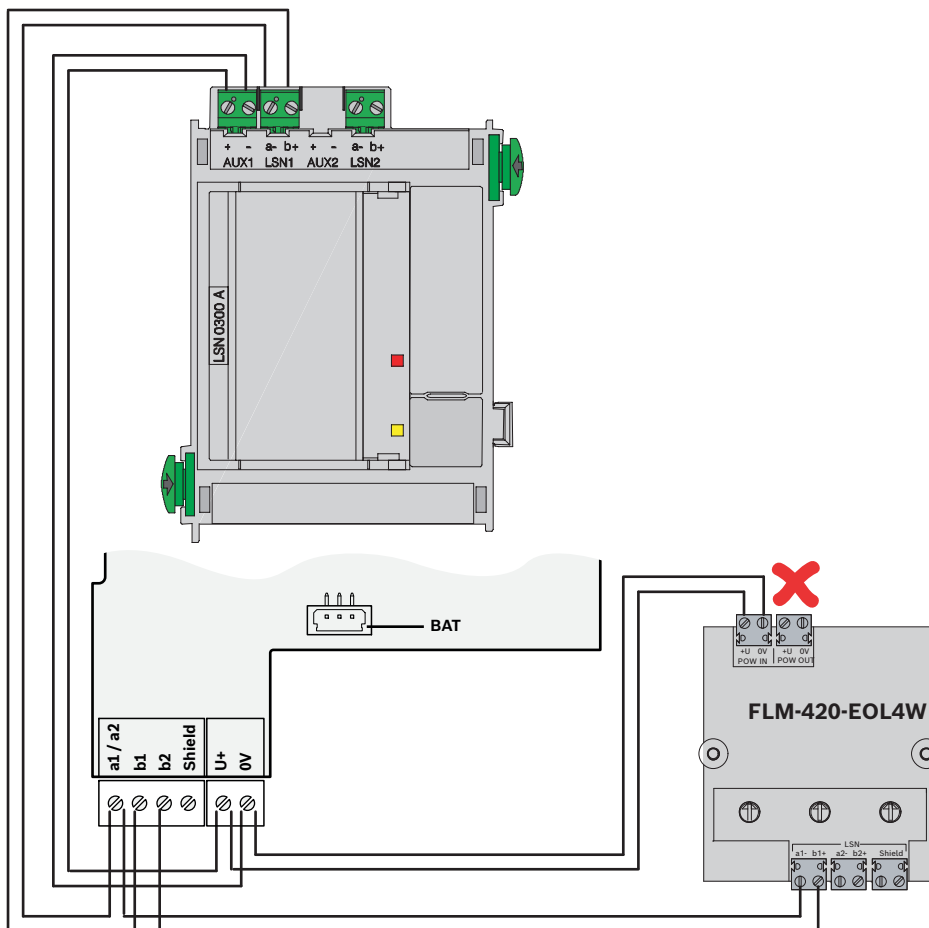

### 2.6.3 FLM-420/4-CON-S/D

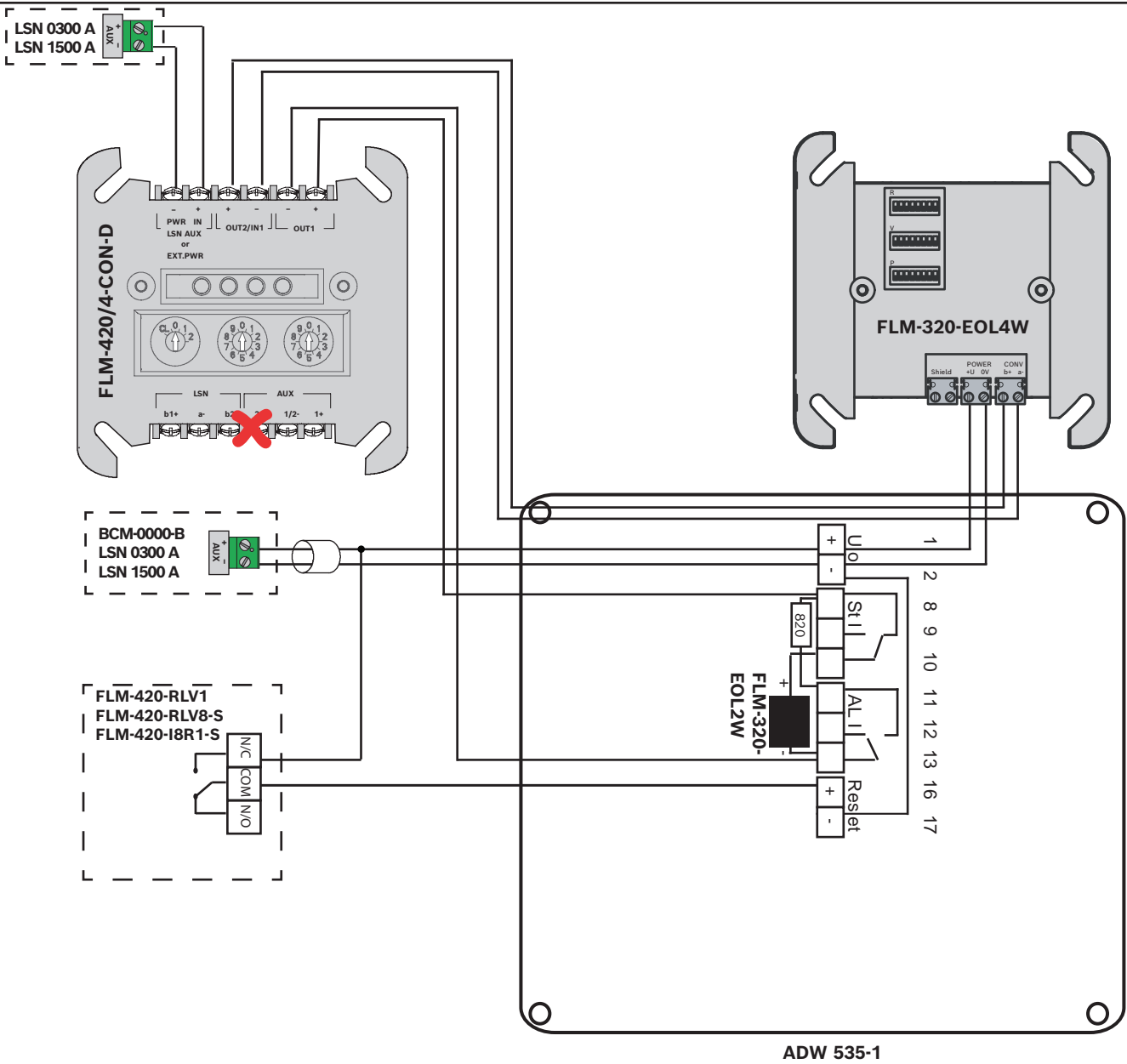
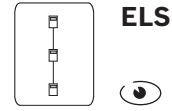

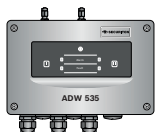

ADW 535-2

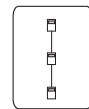

ELS

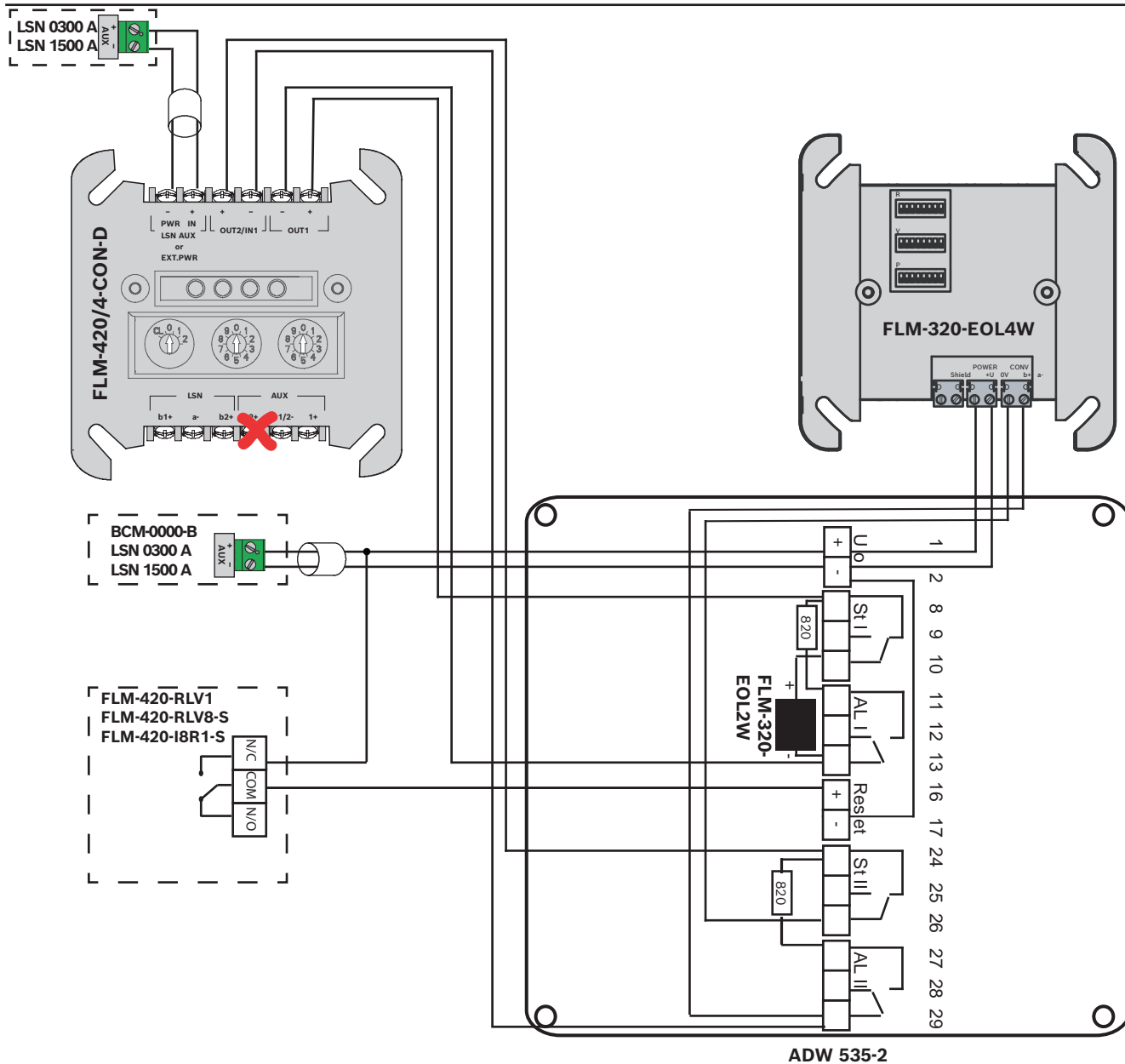

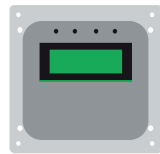

ALARMLINE II



ELS

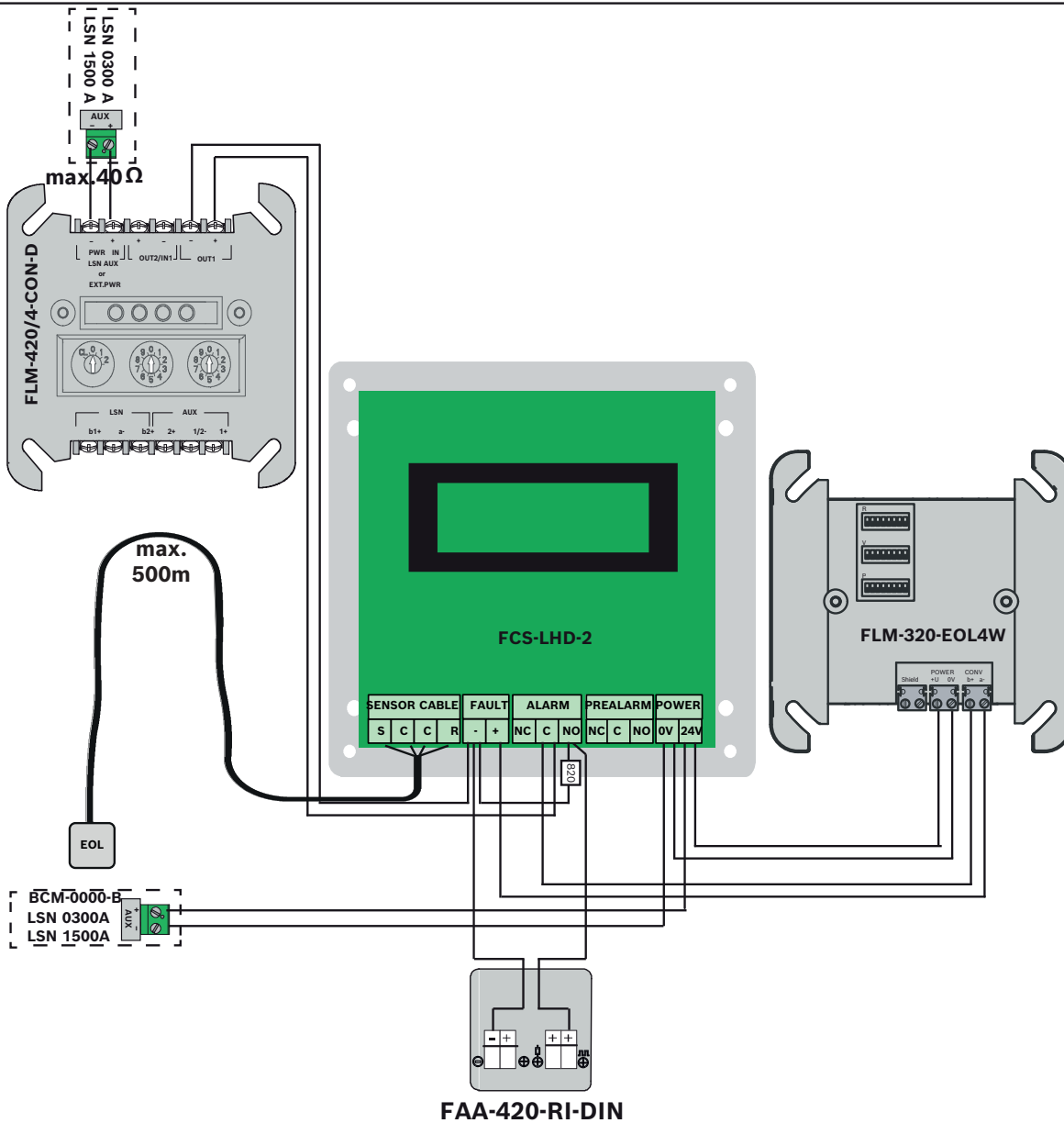



thefirebeam nano  
thefirebeam standard  
thefirebeam foveo

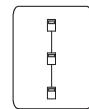

ELS

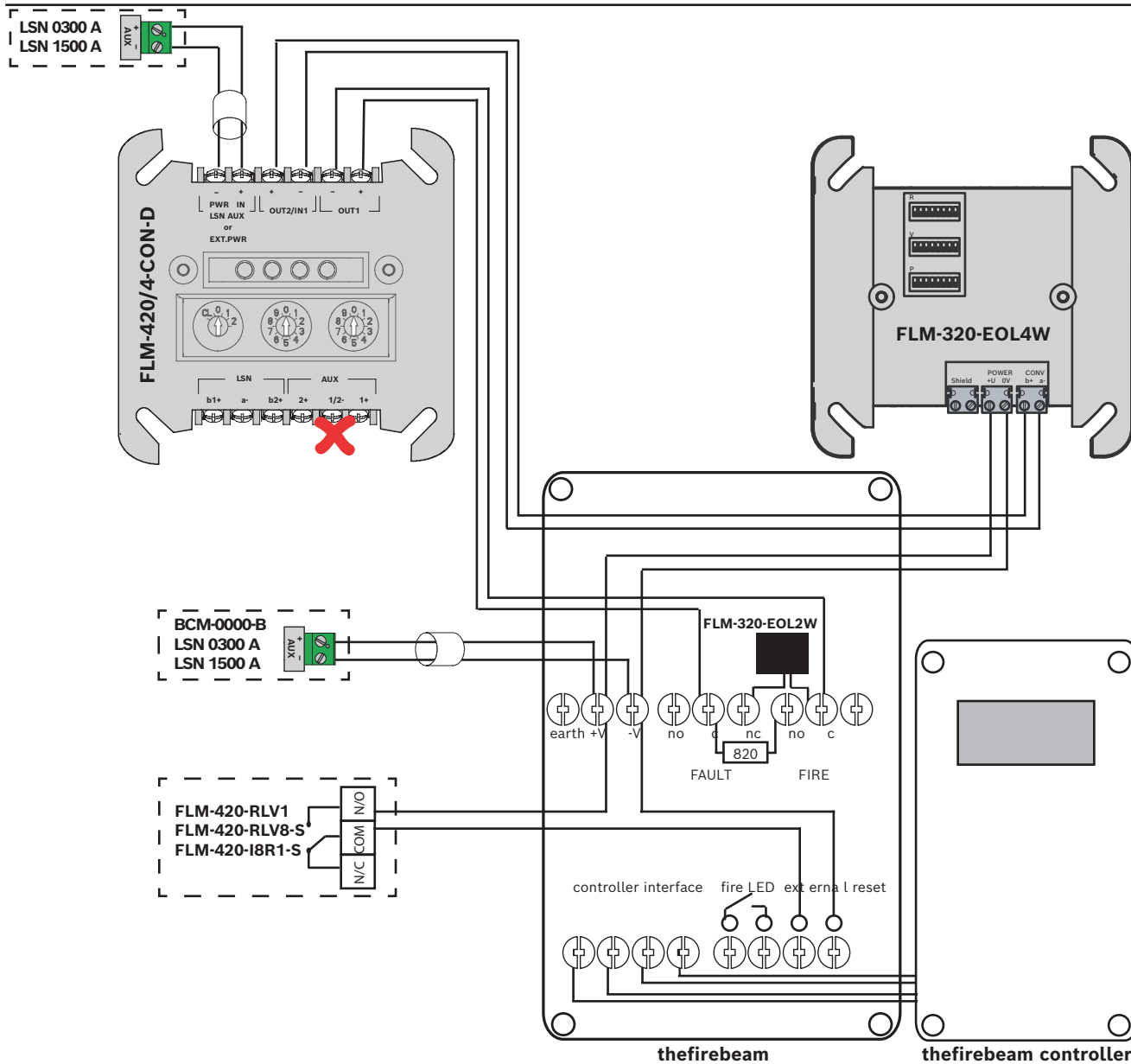

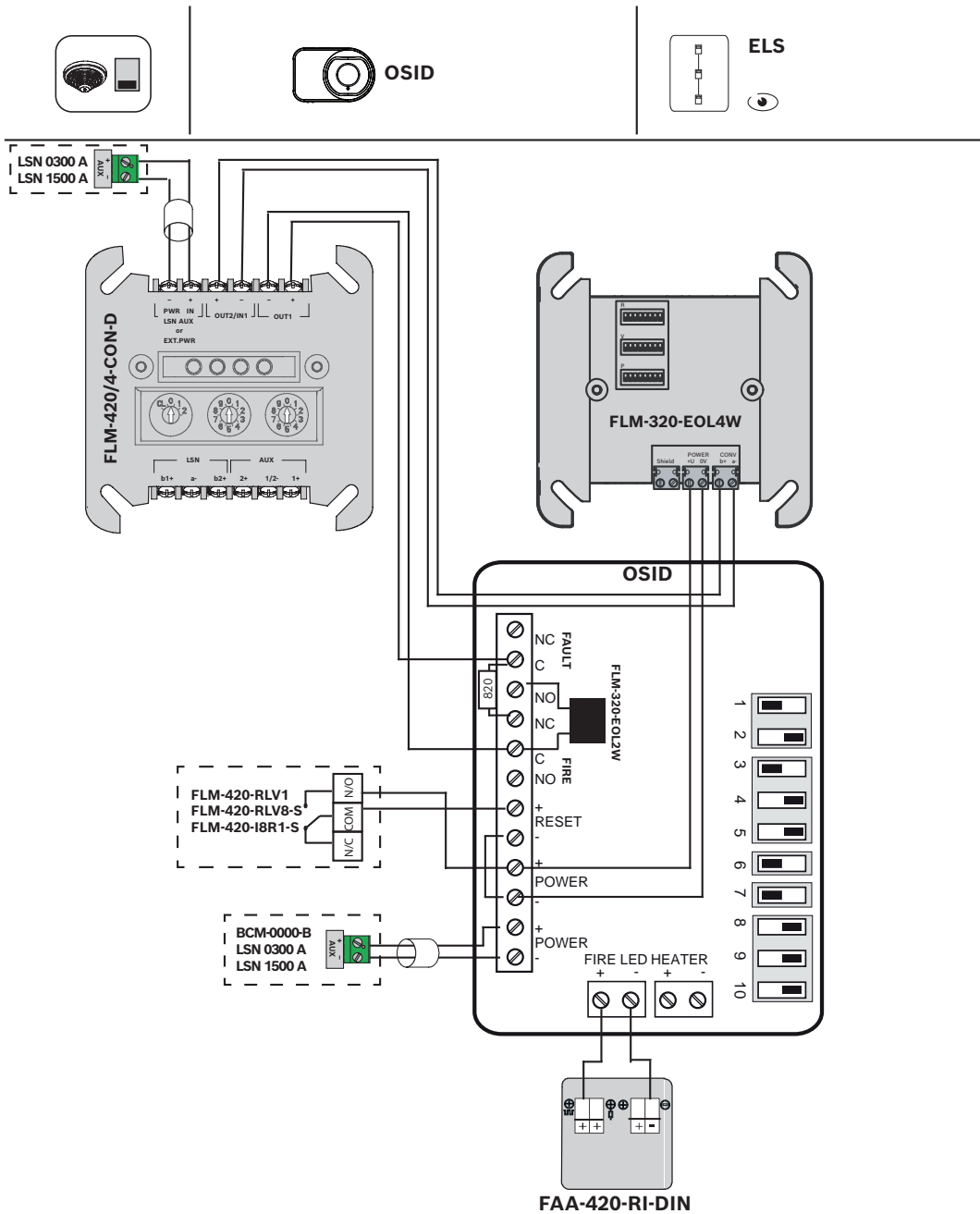



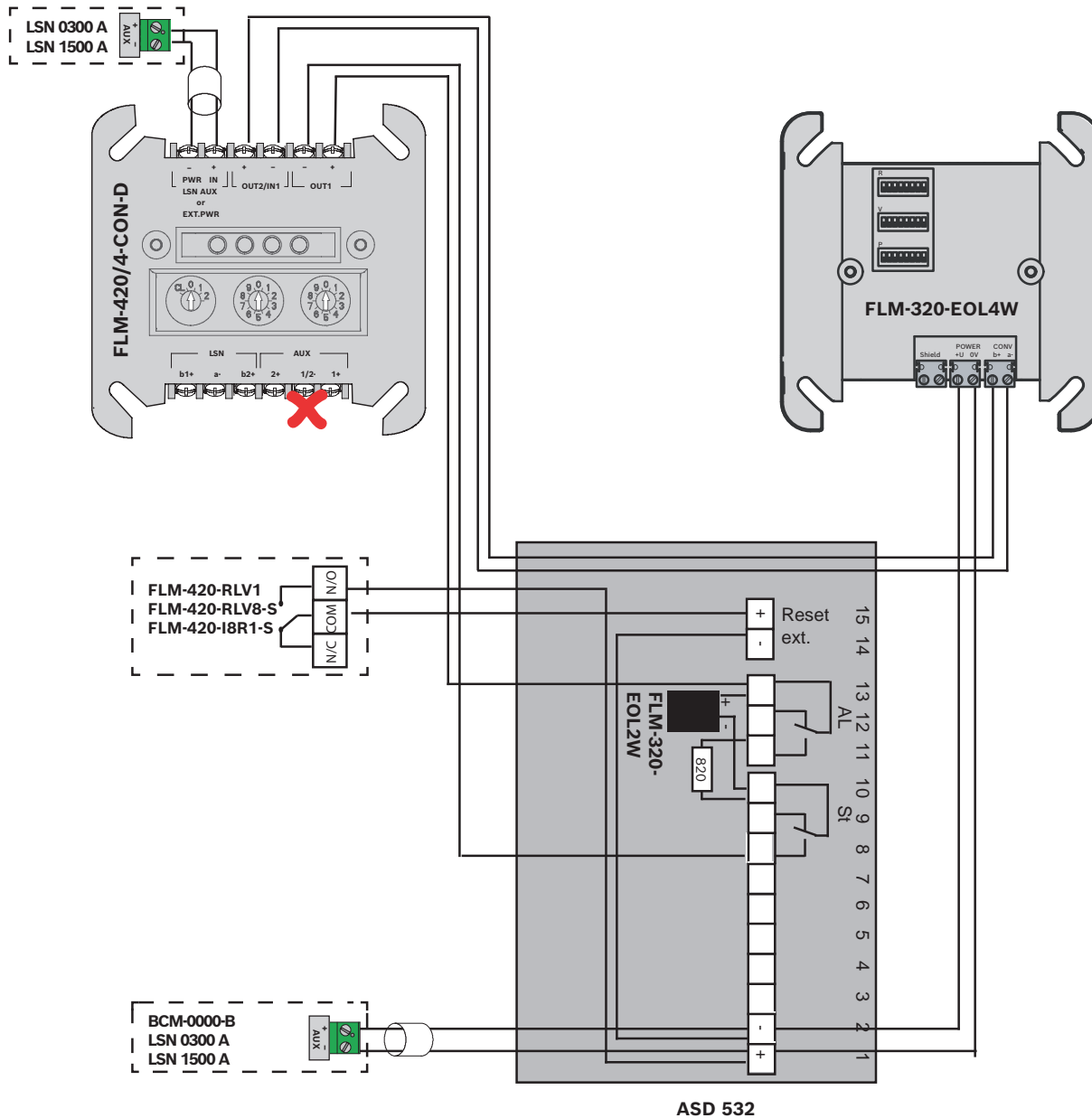
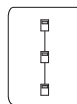

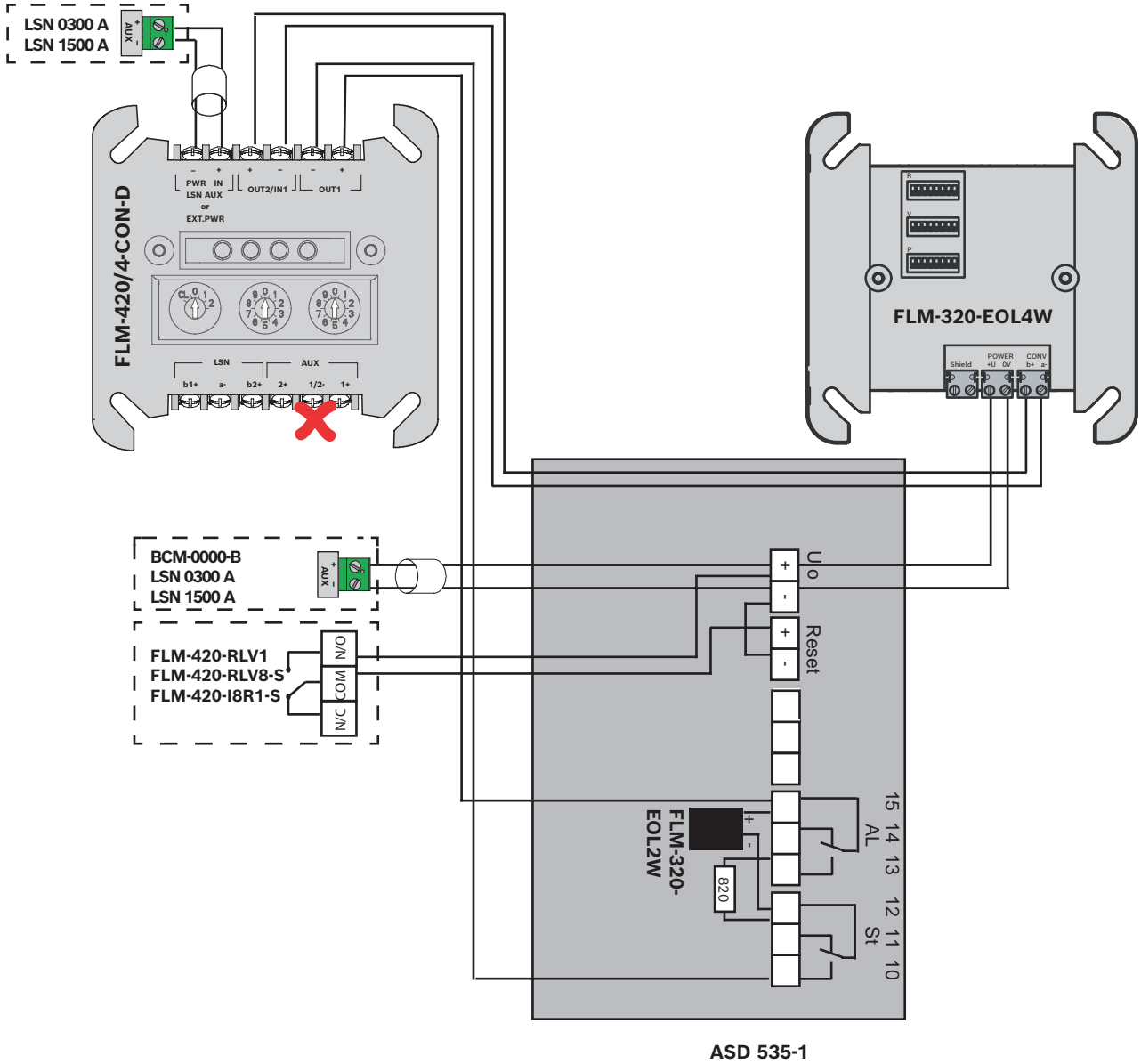
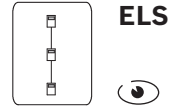

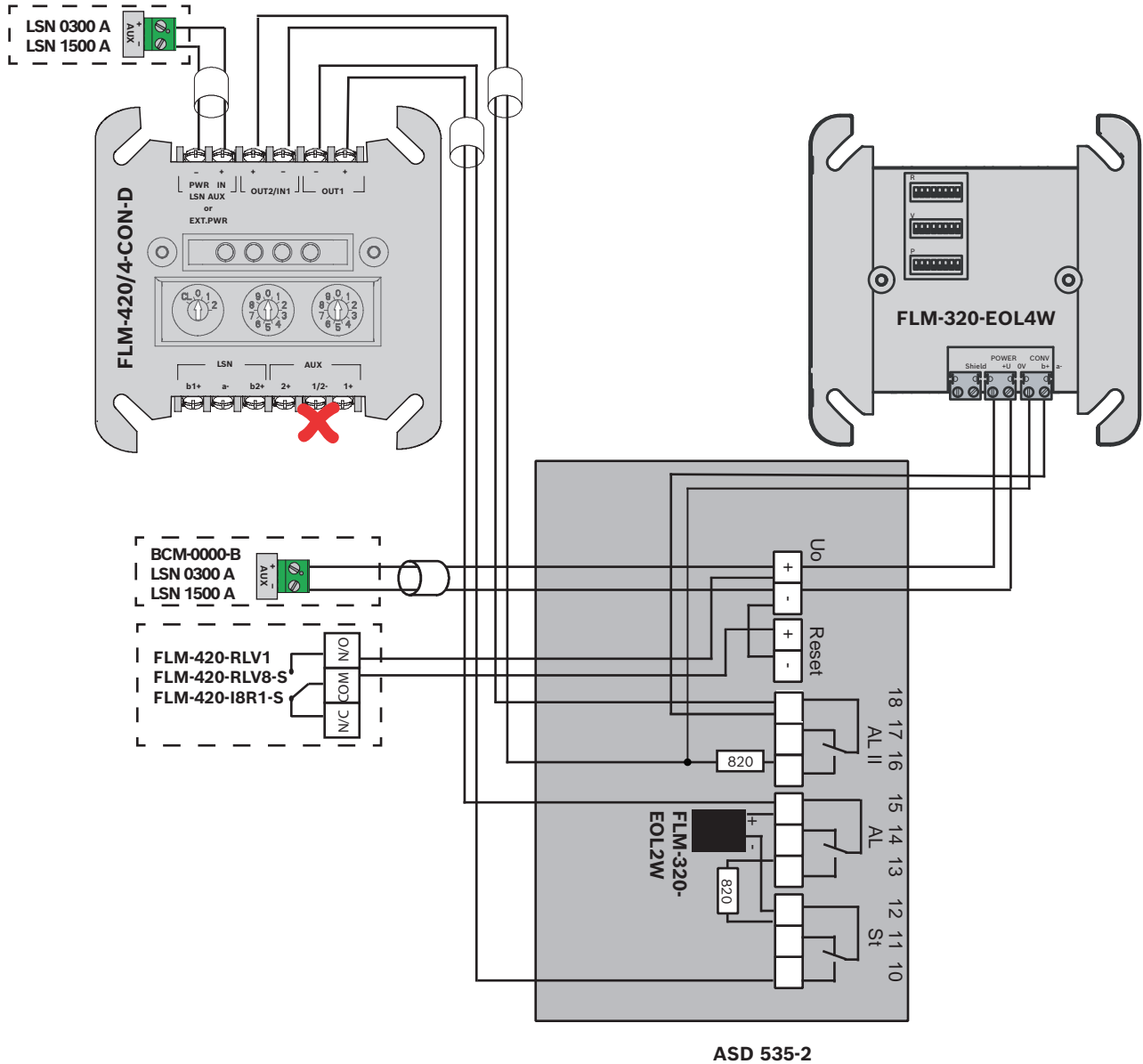
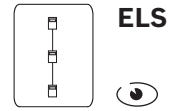

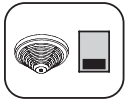

FCS-LWM-1

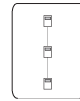

ELS

BCM-0000-B  
LSN 0300 A  
LSN 1500 A

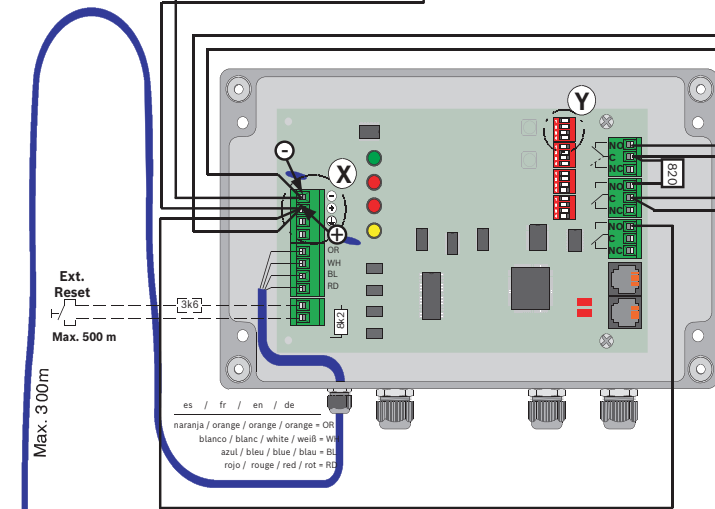
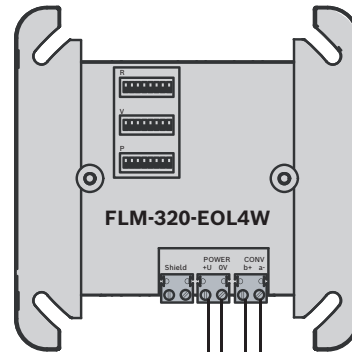
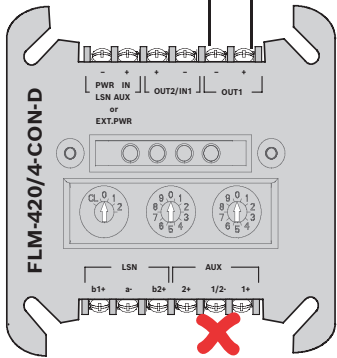

es / fr / en / de  
naranja / orange / orange / orange = OR  
blanco / blanc / white / weiß = WH  
azul / bleu / blue / blau = BL  
rojo / rouge / red / rot = RE



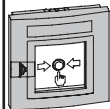
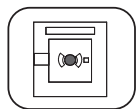

FMC-120-DKM-G-R FMC-120-DKM-G-Y  
 FMC-120-DKM-H-R FMC-120-EST-G-B  
 FMC-120-DKM-G-B  
 FMC-120-DKM-H-B

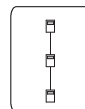

ELS

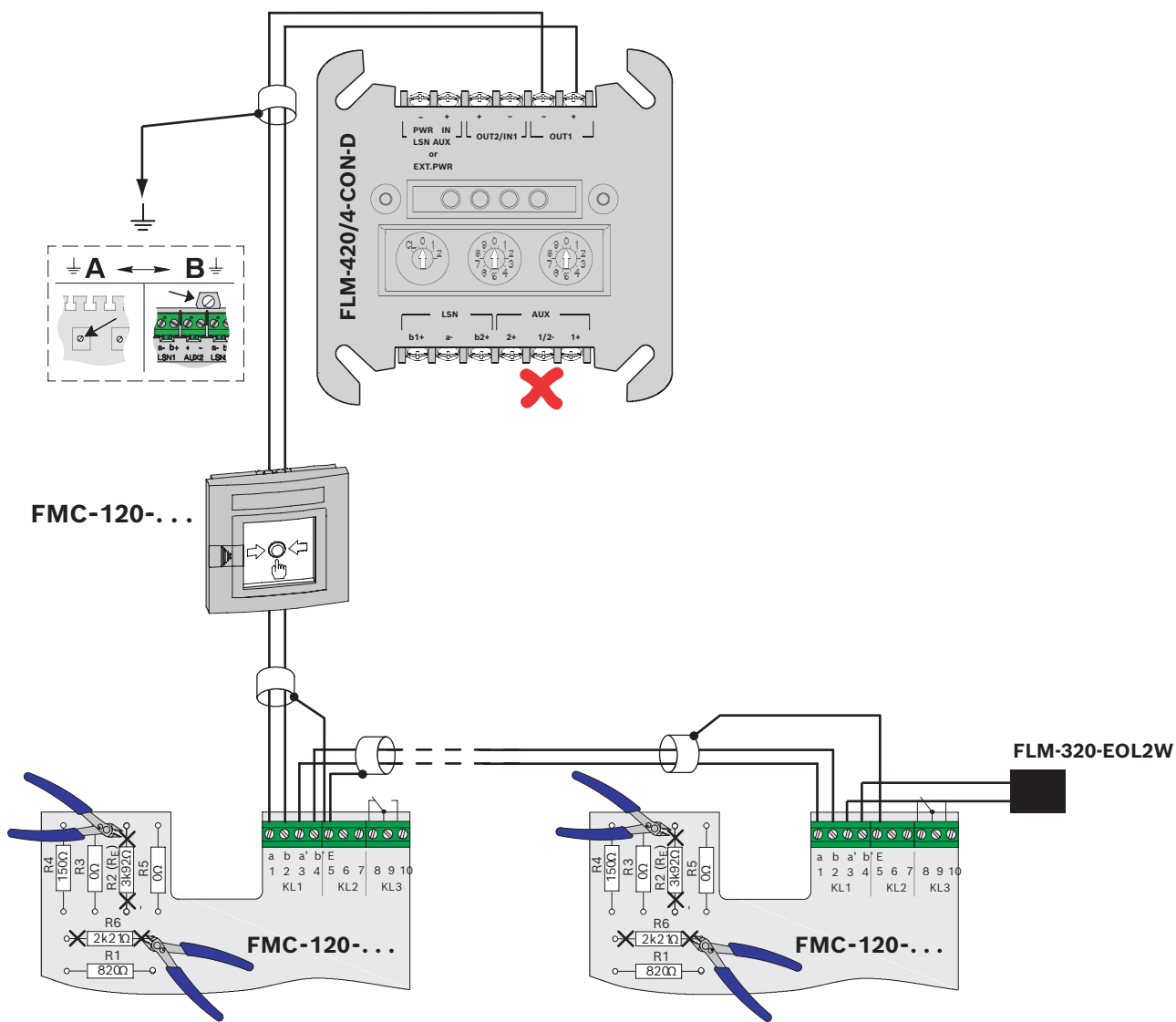

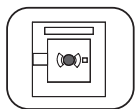

FMC-300

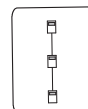

ELS

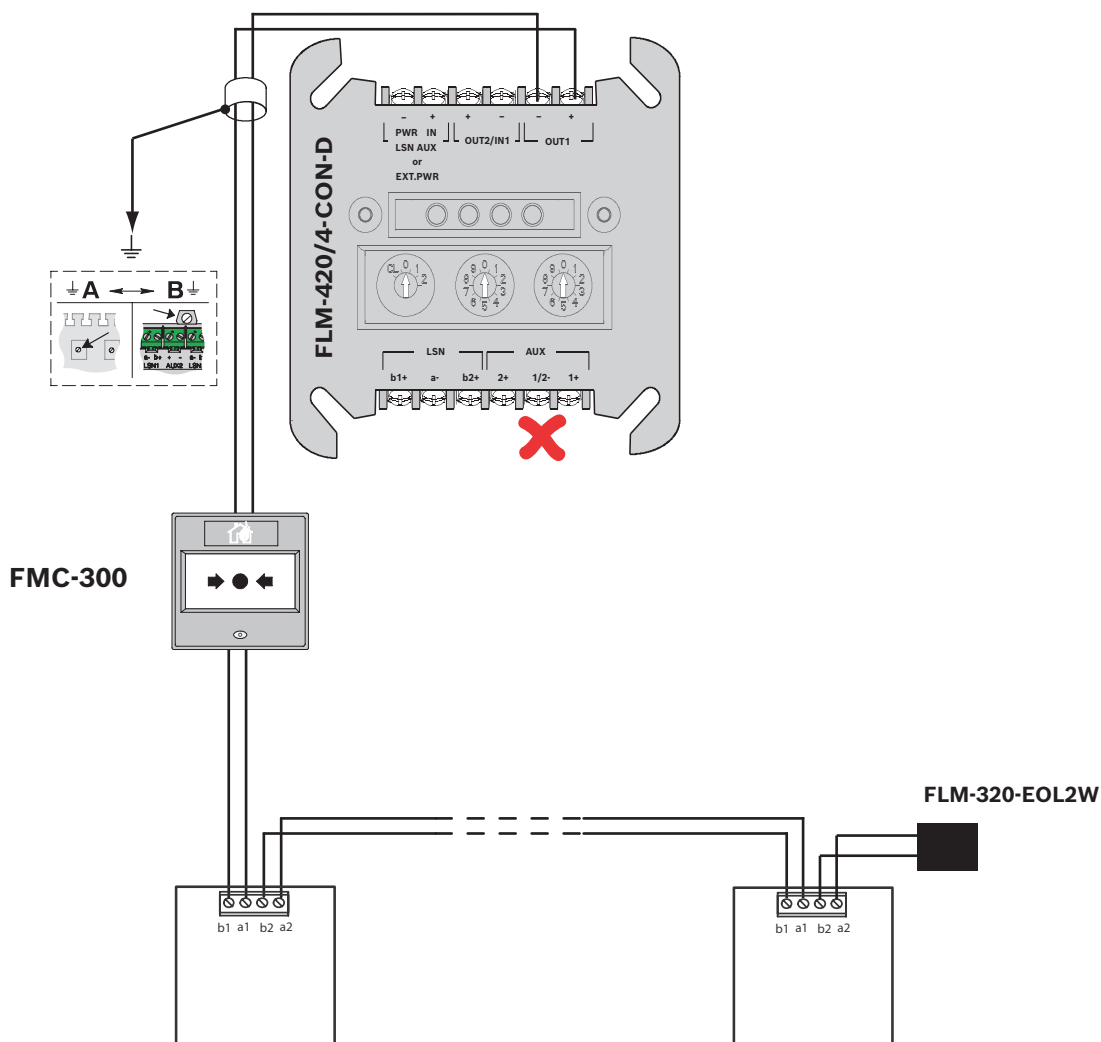

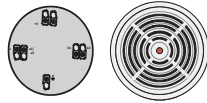

MSS 400, MSS 400 B  
 FCH-320-T320  
 FCH-T320-R470, FCH-T320-FSA  
 FCP-O320, FCP-O320-R470  
 FCP-OC320, FCP-OC320-R470  
 FCP-OT320, FCP-OT320-R470



ELS

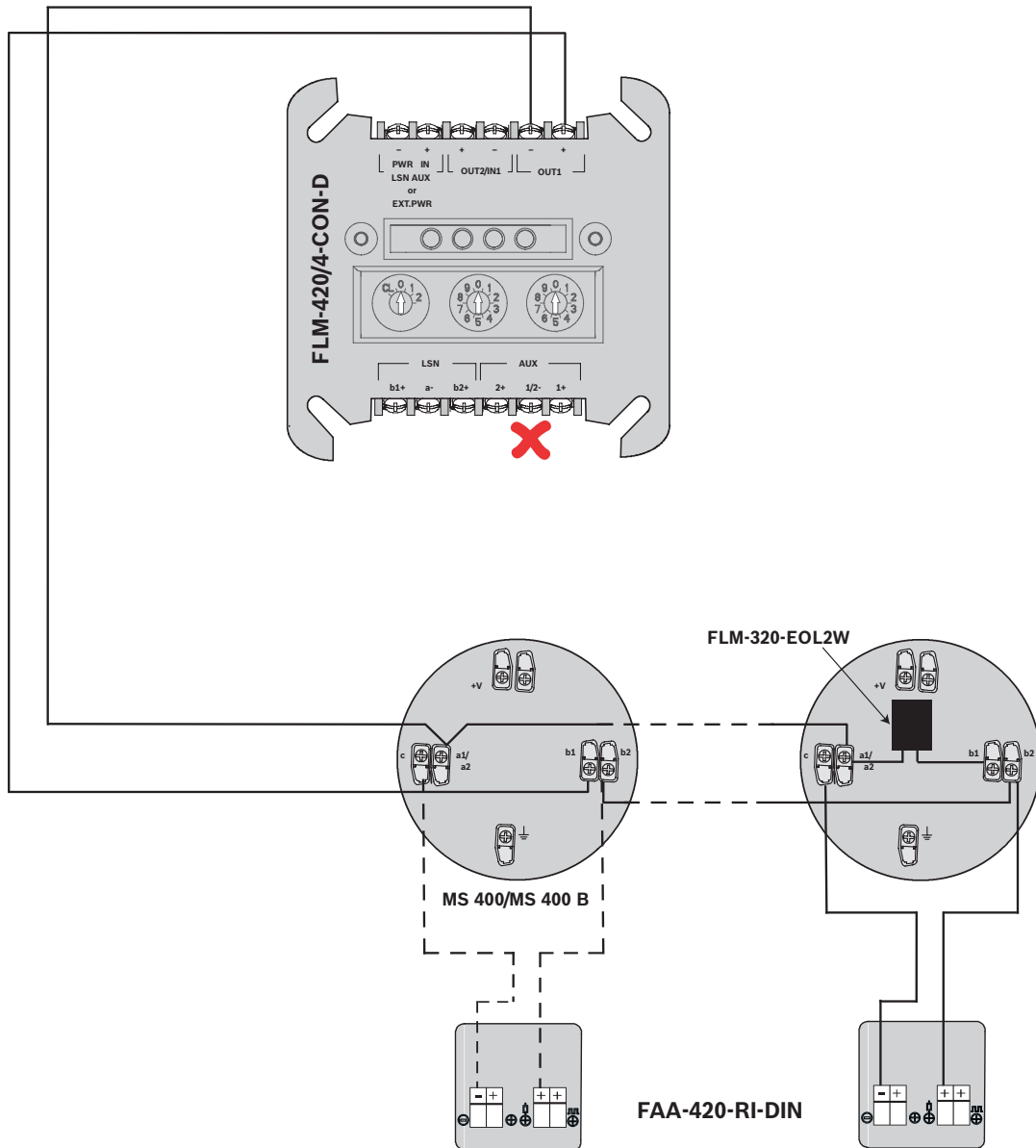



FCP-500



ELS

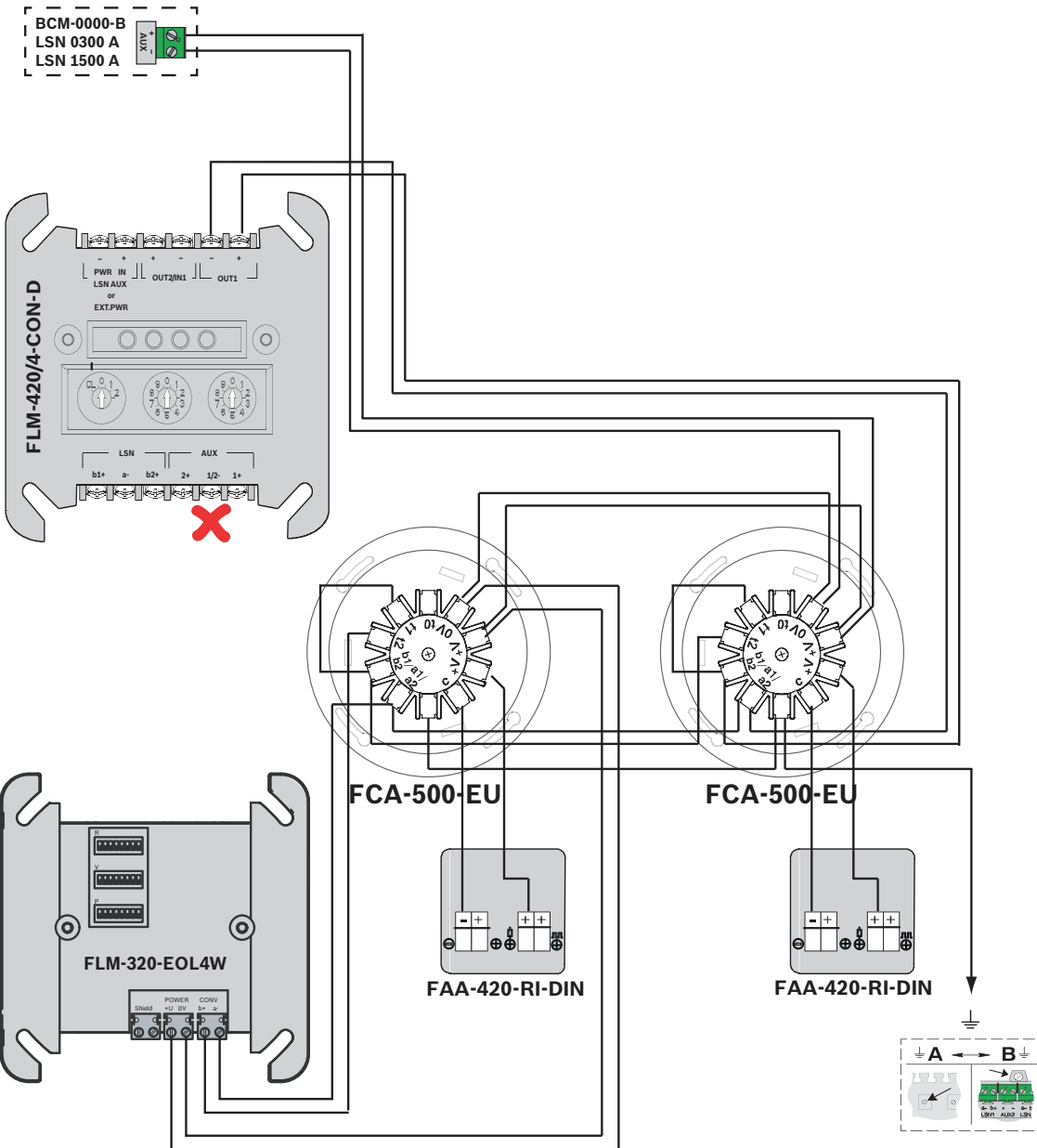



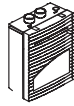

FCS-320-TM Series

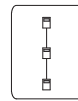

ELS

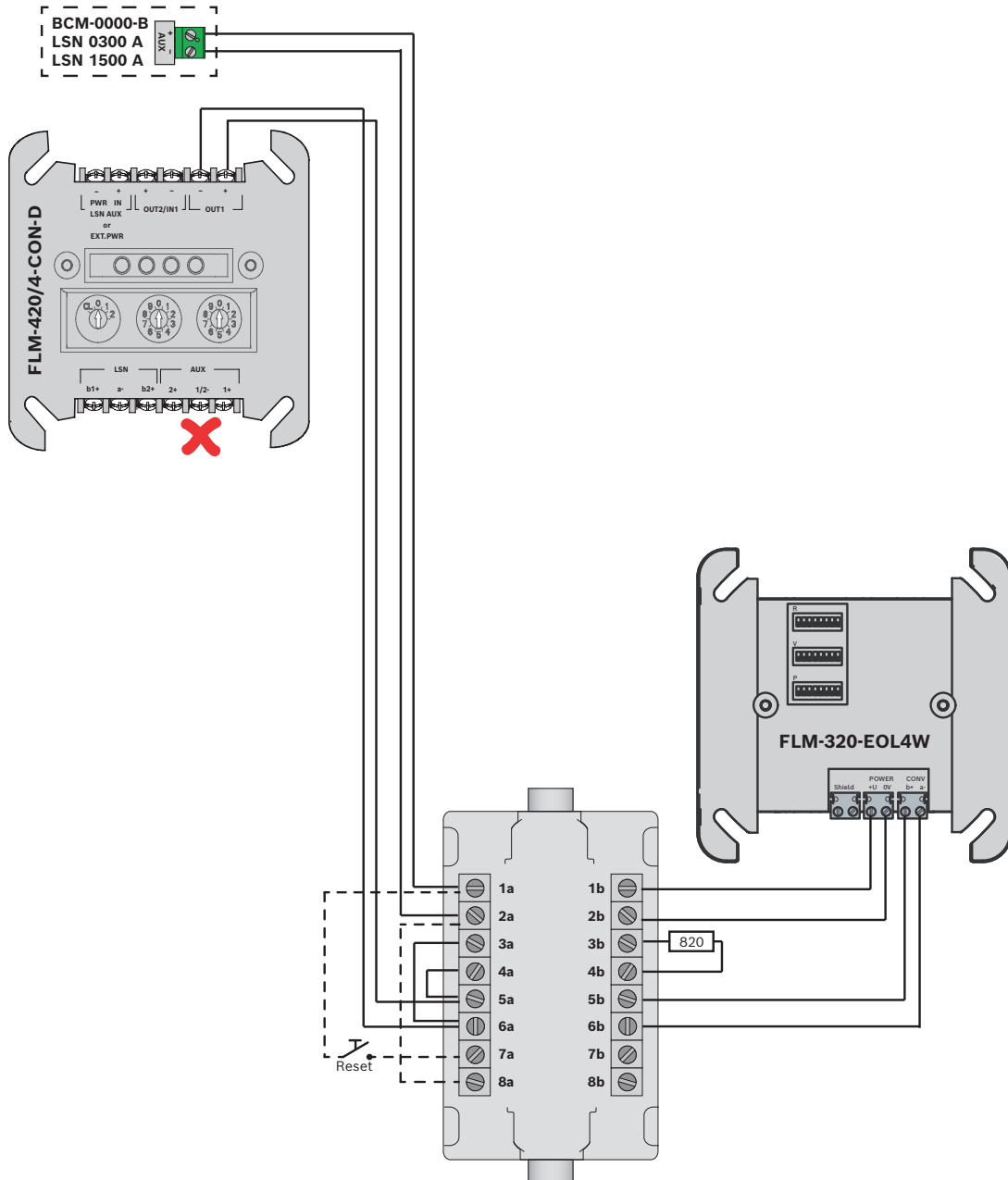

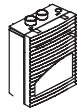

FCS-320-TP Series

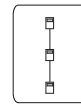

ELS

BCM-0000-B  
LSN 0300 A  
LSN 1500 A

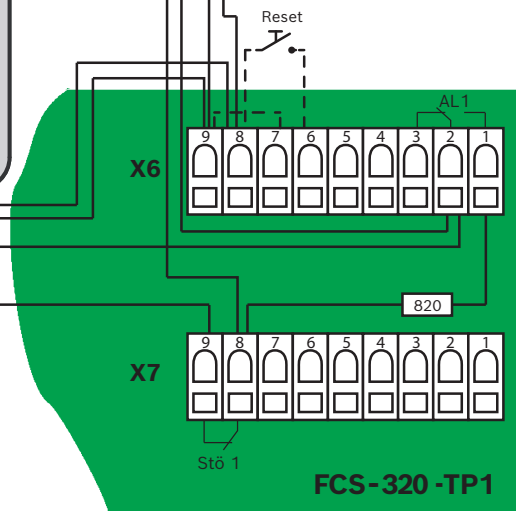
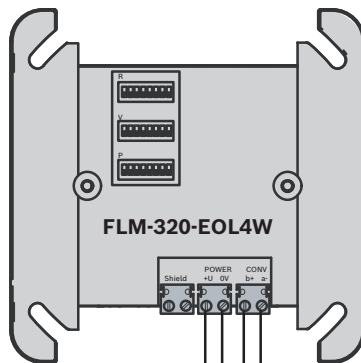
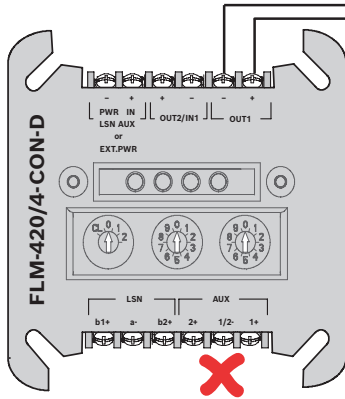

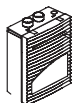

FCS-320-TP Series



ELS

BCM-0000-B  
LSN 0300 A  
LSN 1500 A

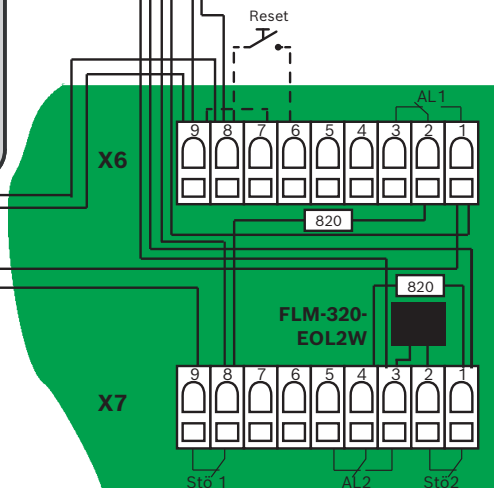
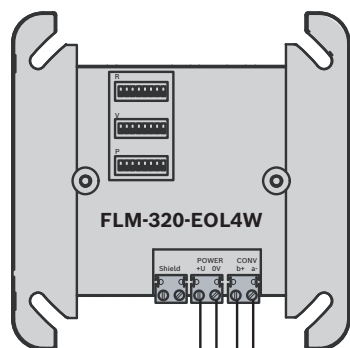
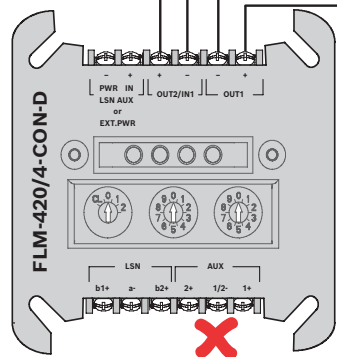

FCS-320-TP2

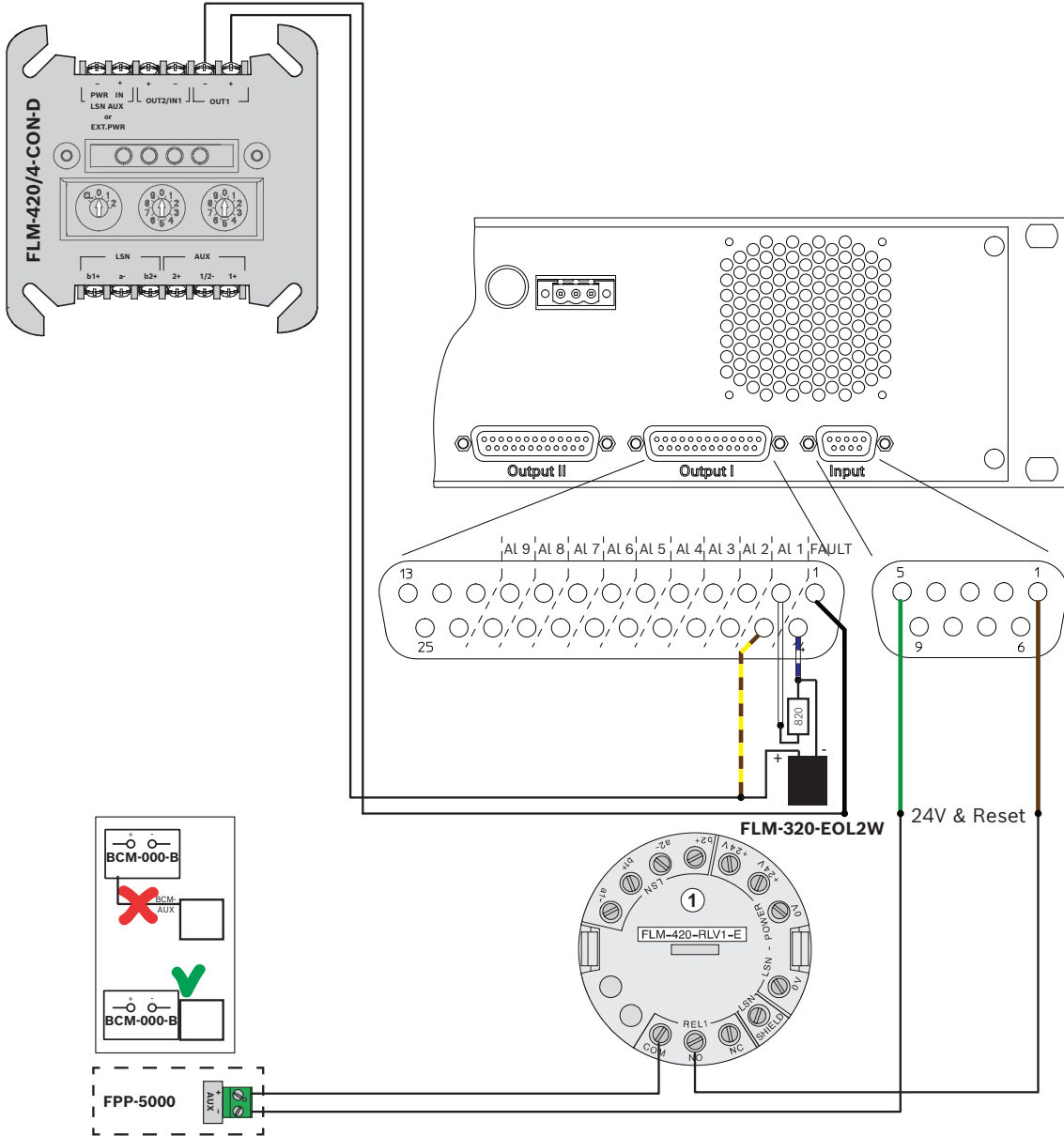
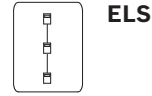

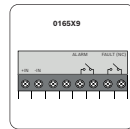

**016519, 016589**  
**IR3 Flame Detector**

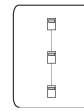

**ELS**

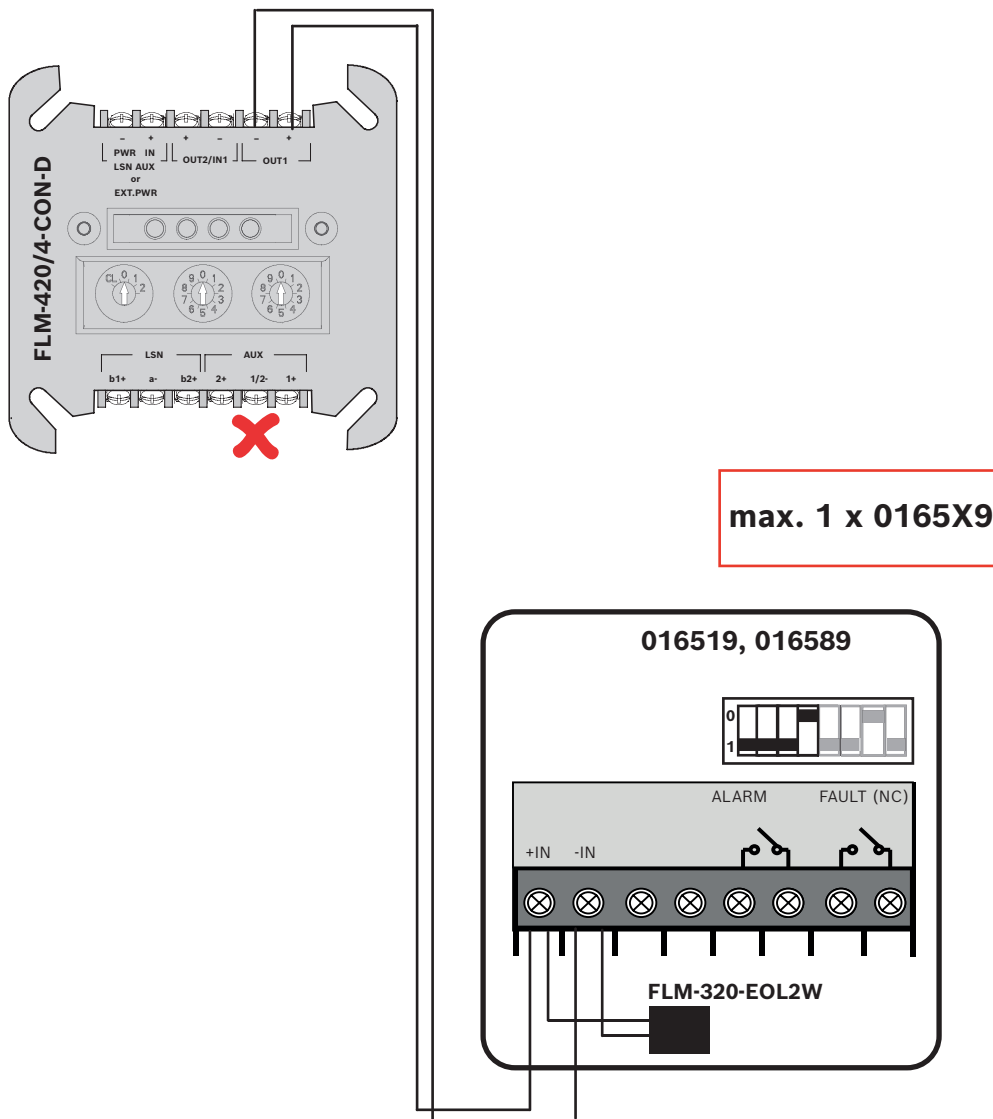

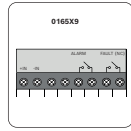

**016519, 016589**  
**IR3 Flame Detector**

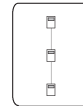

**ELS**

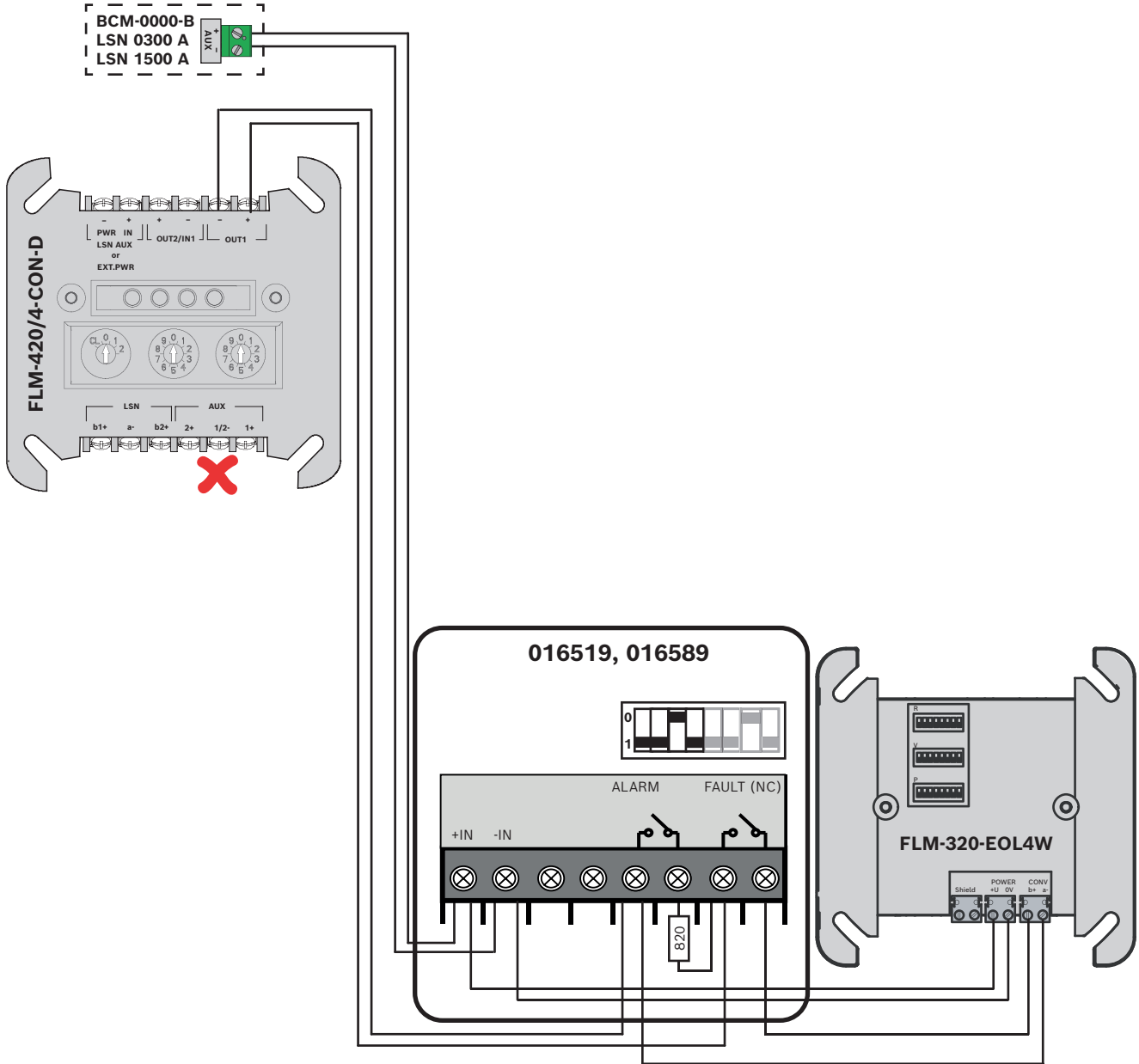



**Fireray 50RV  
Fireray 100RV**

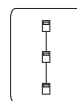

**ELS**

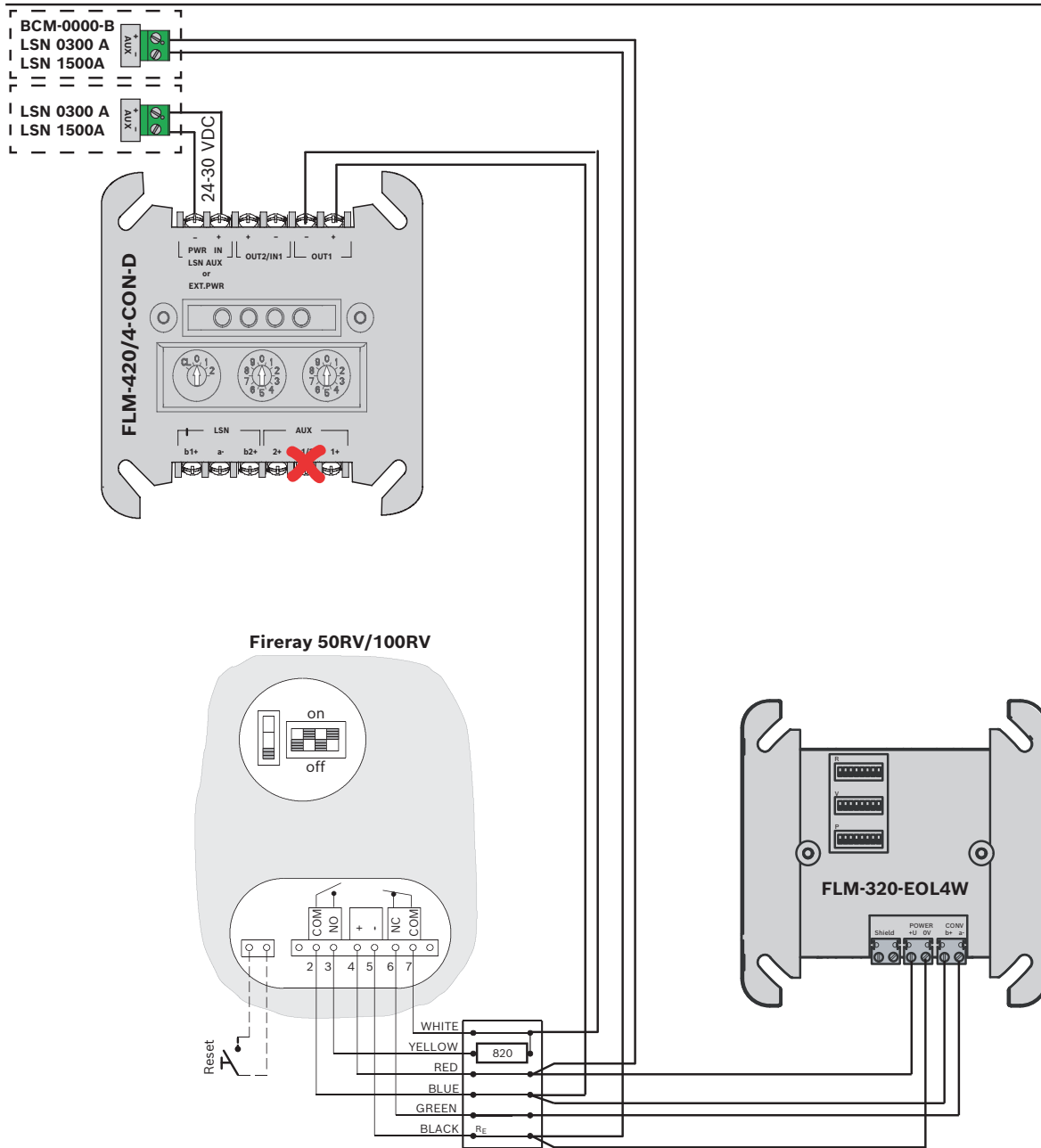

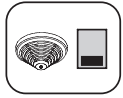

**FIRERAY3000**

1 x

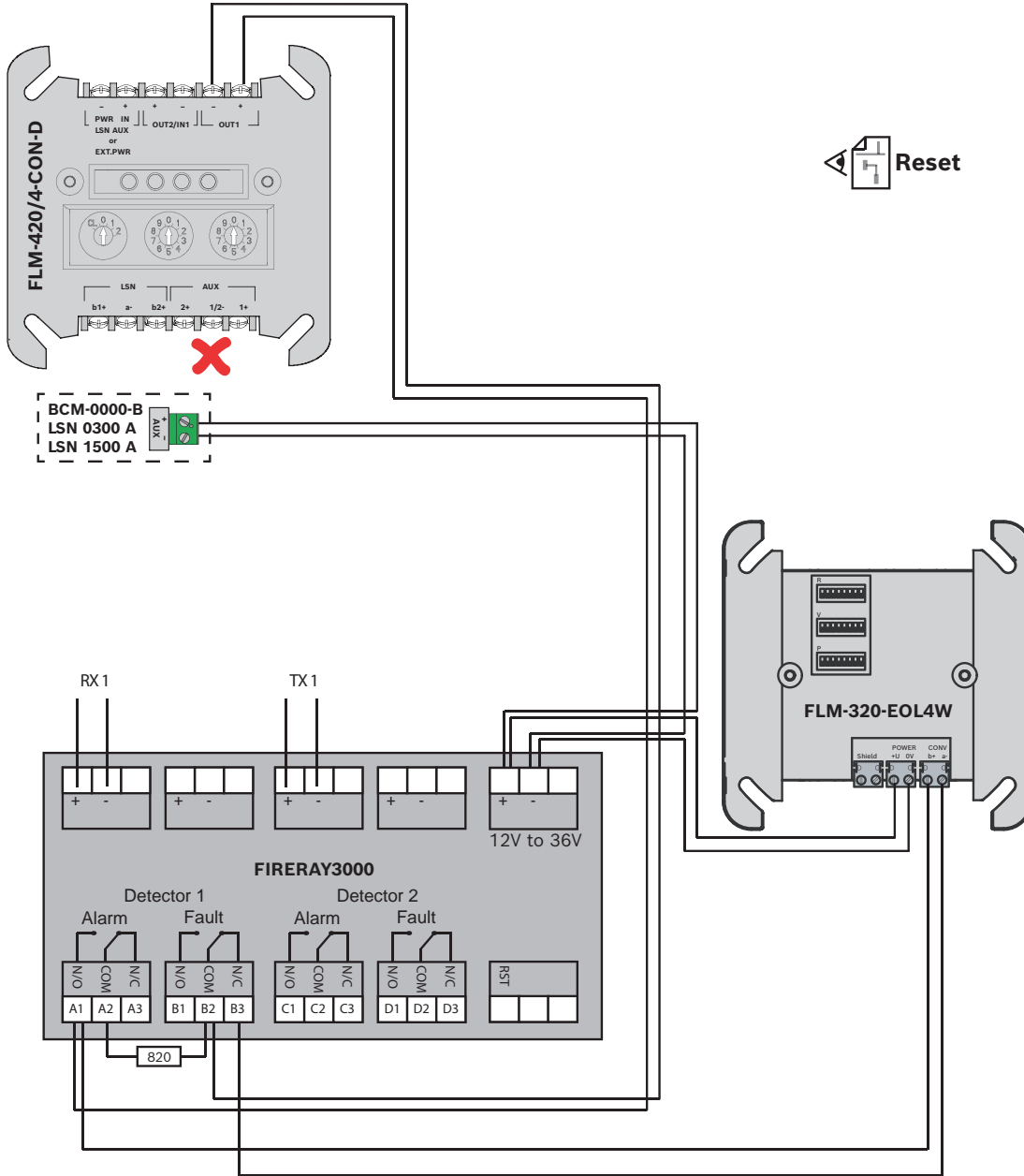
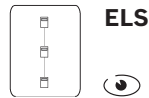





**FIRERAY3000**

2 x   **OUT1**



**ELS**

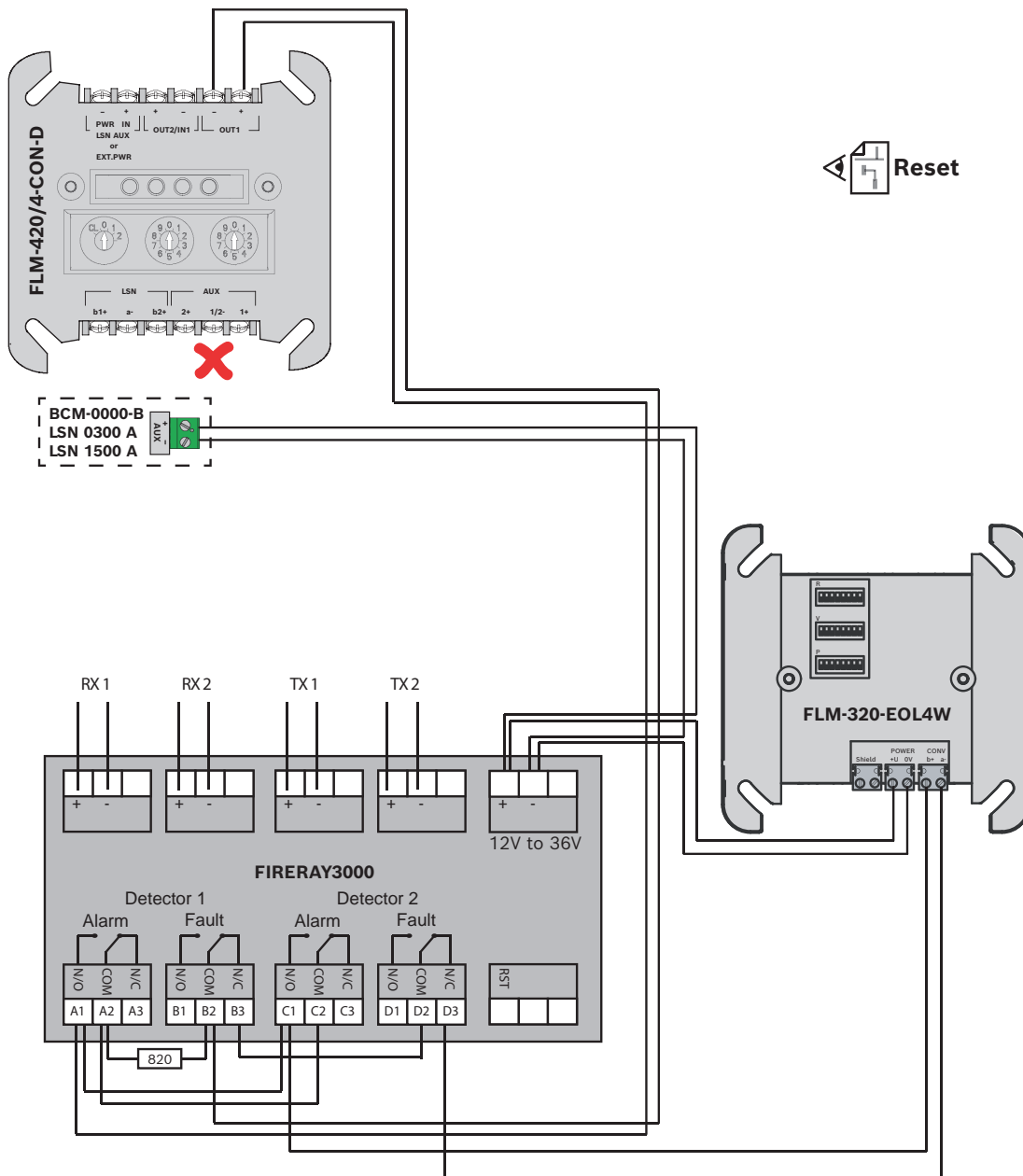



**FIRERAY3000**  
2 x **OUT1+2**



**ELS**

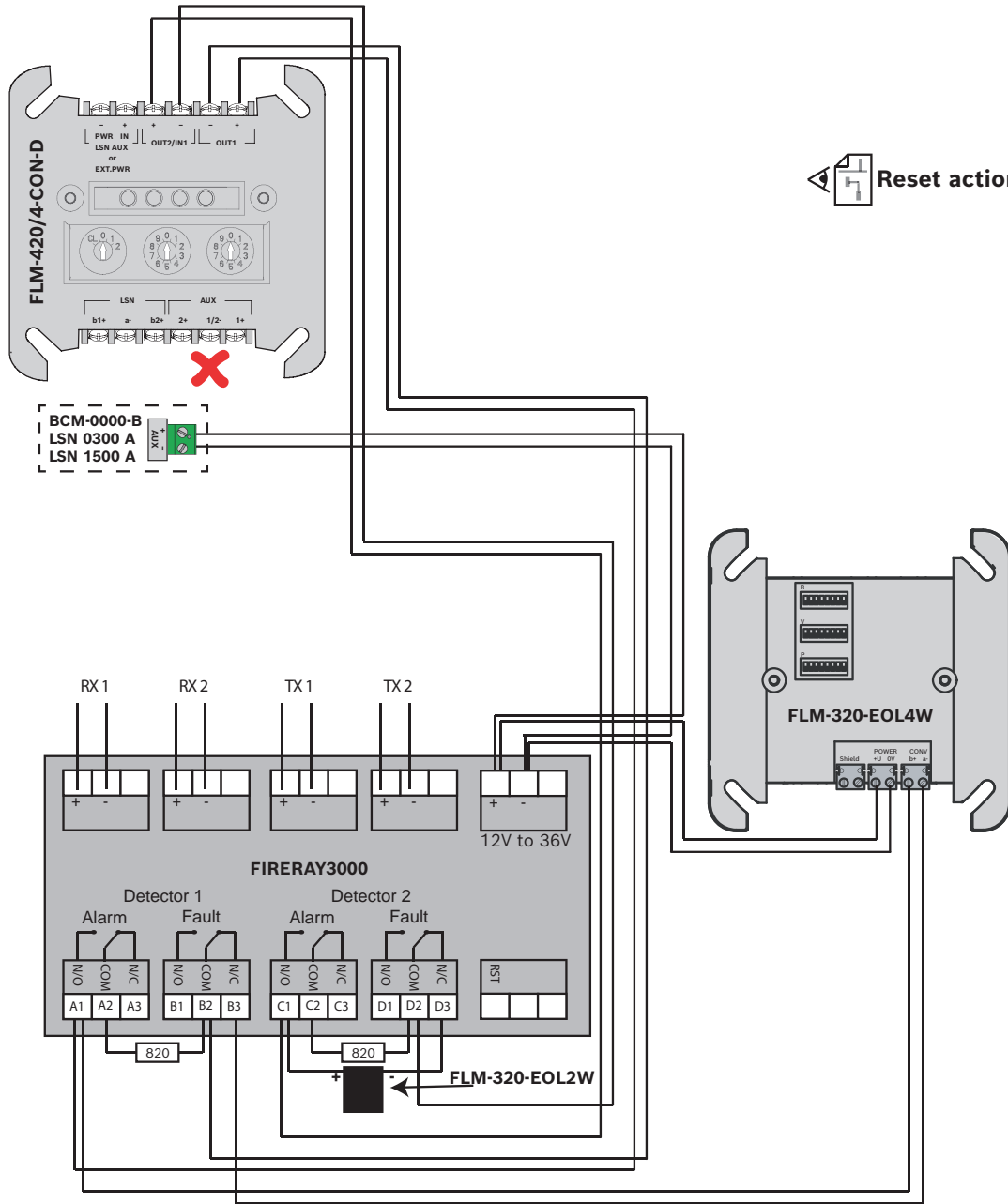



**FIRERAY5000**

1 x



**ELS**

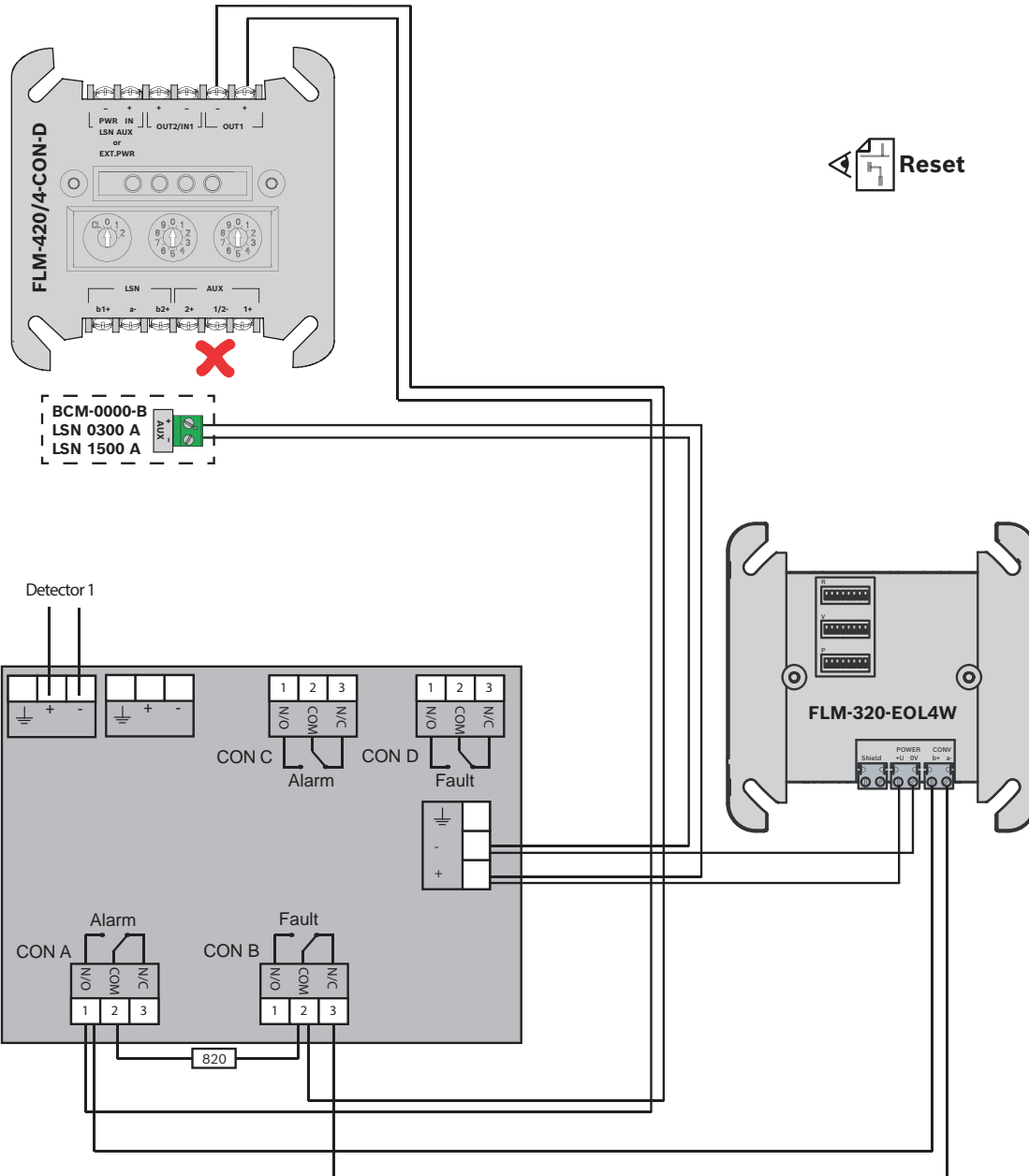



**FIRERAY5000**  
2 x  **OUT1**



**ELS**  

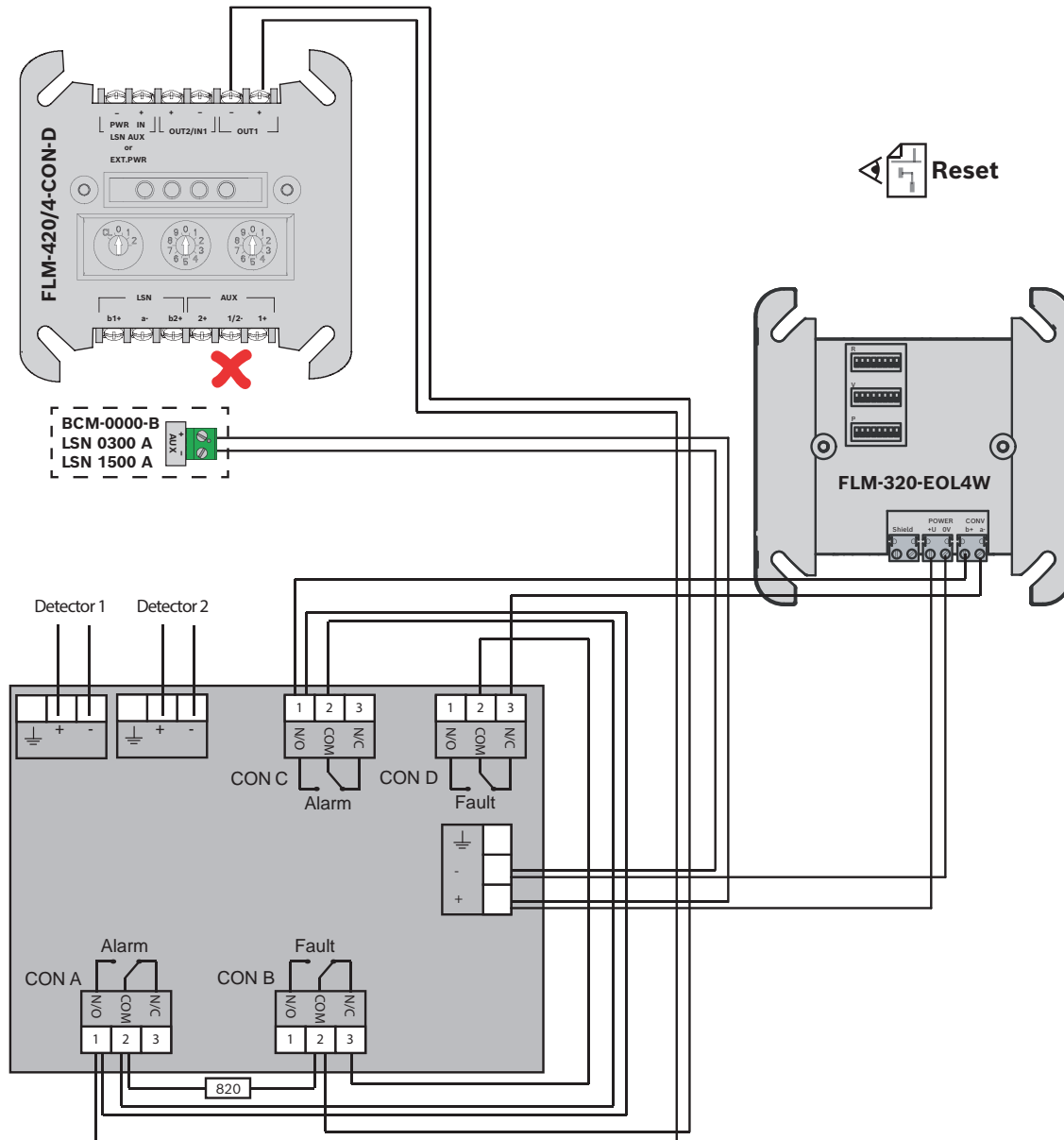

DC1192, SB3  
 OOH740-A9-Ex  
 DO1101A-Ex  
 DT1101A-Ex/DT1102A-Ex  
 DF1101-Ex  
 DM1103B-Ex

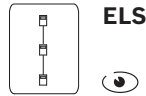

BCM-0000-B  
 LSN 0300 A  
 LSN 1500 A

BCM-0000-B  
 LSN 0300 A  
 LSN 1500 A

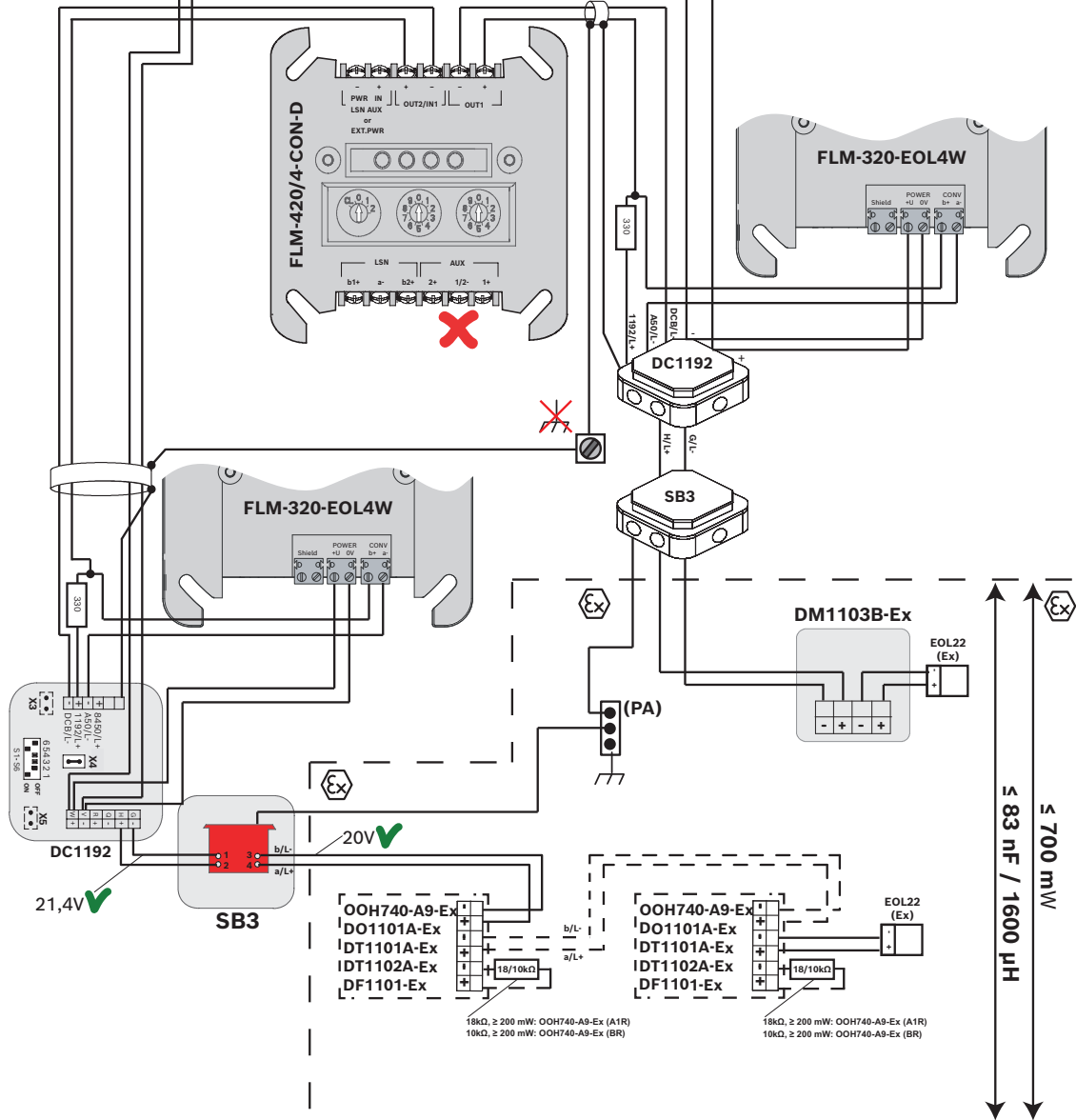

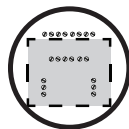

UniVario WMX5000  
 UniVario FMX5000  
 UniVario KMX5000

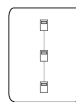

ELS

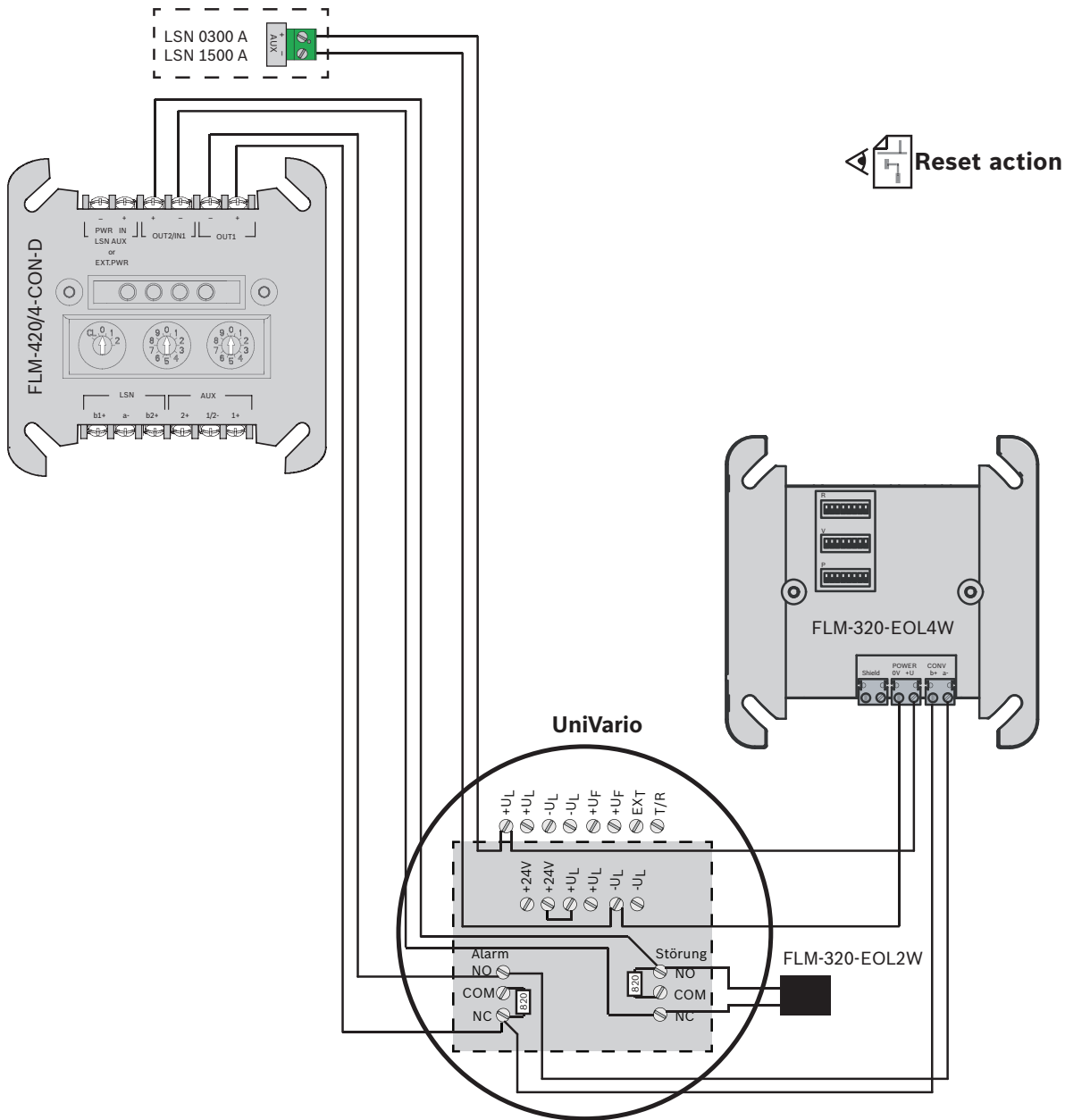

# Indice

## numerici

016519 ->	
CZM 0004 A	52, 53
FLM-420/4-CON-D	134, 135, 136, 137
FLM-420/4-CON-D (EOL)	263, 264
016589 ->	
CZM 0004 A	53
FCS-LWM-1	52
FLM-420/4-CON-D	134, 135, 136, 137
FLM-420/4-CON-D (EOL)	263, 264
2014/2 Ex ->	
FLM-420/4-CON-D	155
2014/2 GLU-Ex ->	
FLM-420/4-CON-D	155
837 ->	
FAA-MSR 420	17, 18
FLM-420-RHV	27, 28
838 ->	
FAA-MSR 420	17, 18
FLM-420-RHV	27, 28
858 ->	
FAA-MSR 420	17, 18
FLM-420-RHV	27, 28

## A

ADW 535-1 ->	
FLM-420/4-CON-D (EOL)	246
FLM-420-RHV	178, 179
ADW 535-2 ->	
FLM-420/4-CON-D (EOL)	247
FLM-420-RHV	180, 181
ALARMLINE II ->	
FLM-420/4-CON-D	125
FLM-420/4-CON-D (EOL)	248
ASD 532 ->	
FLM-420/4-CON-D (EOL)	251
FLM-420-RHV	176, 177
ASD 535-1 ->	
FLM-420/4-CON-D (EOL)	252
FLM-420-RHV	172, 173
ASD 535-2 ->	
FLM-420/4-CON-D (EOL)	253
FLM-420-RHV	174, 175
ASD 535-3 ->	
FLM-420-RHV	172, 173
ASD 535-4 ->	
FLM-420-RHV	174, 175
AT5000 IP/GPRS ->	
ENO 0000 A/B	61
ATB 420 LSNi ->	
LSN 0300 A	93
LSN 0300 A (EOL)	233, 234, 235, 236
ATG 420 LSNi ->	
LSN 0300 A	94
LSN 0300 A (EOL)	237, 238, 239, 240

## B

BCM-0000-B ->	
FPP-5000-TI	11
FPP-5000-TI13	12
BTS 80 ->	
FAA-MSR 420	19, 20
BTS 80 EMB ->	
FLM-420-RHV	29, 30
BTS 80 FLB ->	
FAA-MSR 420	19, 20
FLM-420-RHV	29, 30

<b>C</b>		<b>D</b>	
C31B ->		DC1192, SB3 ->	
LSN 0300 A	103, 104	FLM-420/4-CON-D	149, 150
CZM 0004 A		FLM-420/4-CON-D (EOL)	271
016519	52, 53	DF 1192	
016589	52, 53	FAA-420-RI-DIN	151
FCA-500	58	DF 1192 ->	
FCS-320-TM	54	FLM-420/4-CON-D	151
FCS-320-TP1	55	DF1101-A-EX ->	
FCS-320-TP2	56	FLM-420/4-CON-D	149, 150
FCS-LWM-1	57	FLM-420/4-CON-D (EOL)	271
Fireray 100RV	45	DIBT	
Fireray 50RV	45	837 -> FAA-MSR 420	17, 18
FIRERAY3000	46, 47, 48	837 -> FLM-420-RHV	27, 28
FIRERAY5000	49, 50, 51	838 -> FAA-MSR 420	17, 18
FMC-120	59	838 -> FLM-420-RHV	27, 28
FMC-300	60	858 -> FAA-MSR 420	17, 18
		858 -> FLM-420-RHV	27, 28
		BTS 80 EMB -> FAA-MSR 420	19, 20
		BTS 80 EMB -> FLM-420-RHV	29, 30
		BTS 80 FLB -> FAA-MSR 420	19, 20
		BTS 80 FLB -> FLM-420-RHV	29, 30
		ED 100 -> FAA-MSR-420	15, 16
		ED 100 -> FLM-420-RHV	25, 26
		ED 250 -> FAA-MSR-420	15, 16
		ED 250 -> FLM-420-RHV	25, 26
		GT 40 R -> FAA-MSR 420	17, 18
		GT 40 R -> FLM-420-RHV	27, 28
		GT 42 R -> FAA-MSR 420	17, 18
		GT 42 R -> FLM-420-RHV	27, 28
		GT 50 R -> FAA-MSR 420	17, 18
		GT 50 R -> FLM-420-RHV	27, 28
		GT 60 R -> FAA-MSR 420	17, 18
		GT 60 R -> FLM-420-RHV	27, 28
		GT 63 R -> FAA-MSR 420	17, 18
		GT 63 R -> FLM-420-RHV	27, 28
		GT 70 R -> FAA-MSR 420	17, 18
		GT 70 R -> FLM-420-RHV	27, 28
		GT 70 R 050.01 Ex -> FAA-MSR 420	17, 18
		GT 70 R 050.01 Ex -> FLM-420-RHV	27, 28
		Slimdrive EMD-F -> FAA-MSR-420	21, 22
		Slimdrive EMD-F -> FLM-420-RHV	31, 32
		Slimdrive EMD-F-IS -> FAA-MSR-420	21, 22
		Slimdrive EMD-F-IS -> FLM-420-RHV	31, 32
		TS 4000 E -> FAA-MSR-420	23, 24
		TS 4000 E -> FLM-420-RHV	33, 34
		TS 4000 EFS -> FAA-MSR-420	23, 24
		TS 4000 EFS -> FLM-420-RHV	33, 34
		TS 4000 E-IS -> FAA-MSR-420	23, 24



TS 4000 E-IS -> FLM-420-RHV	33, 34	EOL	201, 202, 203
TS 5000 E -> FAA-MSR-420	23, 24	016519 -> FLM-420/4-CON-D	263, 264
TS 5000 E -> FLM-420-RHV	33, 34	016519 ->:CZM 0004 A	189, 190
TS 5000 E-IS -> FAA-MSR-420	23, 24	016589 -> FLM-420/4-CON-D	263, 264
TS 5000 E-IS -> FLM-420-RHV	33, 34	016589 ->:CZM 0004 A	190
TS 5000 E-ISM -> FAA-MSR-420	23, 24	ADW 535-1 -> FLM-420/4-CON-D	246
TS 5000 E-ISM -> FLM-420-RHV	33, 34	ADW 535-2 -> FLM-420/4-CON-D	247
TS 550 E -> FAA-MSR-420	23, 24	ALARMLINE II -> FLM-420/4-CON-D	248
TS 550 E -> FLM-420-RHV	33, 34	ASD 532 -> FLM-420/4-CON-D	251
TS 73 EMF -> FAA-MSR 420	19, 20	ASD 535-1 -> FLM-420/4-CON-D	252
TS 73 EMF -> FLM-420-RHV	29, 30	ASD 535-2 -> FLM-420/4-CON-D	253
TS 93 EMF -> FAA-MSR 420	19, 20	ATB 420 LSNi -> LSN 0300 A	233, 234, 235, 236
TS 93 EMF -> FLM-420-RHV	29, 30	ATG 420 LSNi -> LSN 0300 A	237, 238, 239, 240
TS 93 GSR/EMF1 -> FAA-MSR 420	19, 20	CZM 0004 A: FCS-320-TM	192
TS 93 GSR/EMF1 -> FLM-420-RHV	29, 30	CZM 0004 A: FCS-320-TP1	193
TS 93 GSR/EMF2 -> FAA-MSR 420	19, 20	CZM 0004 A: FCS-320-TP2	194
TS 93 GSR/EMF2 -> FLM-420-RHV	29, 30	CZM 0004 A: FIRERAY3000	195, 196, 197
TSA 160 NT F -> FAA-MSR-420	23, 24	CZM 0004 A: FIRERAY5000	198
TSA 160 NT F -> FLM-420-RHV	33, 34	CZM 0004 A: FMC-120	199
TSA 160 NT F-IS -> FAA-MSR-420	23, 24	CZM 0004 A: FMC-300	200
TSA 160 NT F-IS -> FLM-420-RHV	33, 34	CZM 0004 A:016519	190
TSA 160 NT F-IS/TS -> FAA-MSR-420	23, 24	CZM 0004 A:016589	189, 190
TSA 160 NT F-IS/TS -> FLM-420-RHV	33, 34	CZM 0004 A:FCA-500-EU	191
TSZ 0400 -> FLM-420/4-CON-D	36	CZM 0004A:016519	189
TSZ 0400 -> FLM-420-I2-E-/W	37	CZM 0004A:016589	189
TSZ 0400 -> FLM-420-O1I1-E	38	DC1192, SB3 -> FLM-420/4-CON-D	271
DM 1103B-X ->		DF1101-A-EX -> FLM-420/4-CON-D	271
FLM-420/4-CON-D	149, 150	DM 1103B-X -> FLM-420/4-CON-D	271
FLM-420/4-CON-D (EOL)	271	DO1101-A-EX -> FLM-420/4-CON-D	271
DO1101-A-EX ->		FAA-500 -> LSN 0300 A	220
FLM-420/4-CON-D	149, 150	FAA-500-R -> LSN 0300 A	220
FLM-420/4-CON-D (EOL)	271	FAA-MSR 420 -> LSN 0300 A	221
<b>E</b>		FAP-425	257
ED 100 ->		FAP-425 -> LSN 0300 A	221, 222
FAA-MSR-420	15, 16	FAP-520 -> LSN 0300 A	220
FLM-420-RHV	25, 26	FAS-420 -> LSN 0300 A	223, 224
ED 250 ->		FAS-420-TM -> LSN 0300 A	225, 226, 227, 228
FAA-MSR-420	15, 16	FBF 100 LSN -> LSN 0300 A	229, 230, 231, 232
FLM-420-RHV	25, 26	FCA-500-EU -> FLM-420/4-CON-D	258
ELS VdS 2489	7, 68	FCA-500-EU ->:CZM 0004 A	191
ENO 0000 A		FCH-320	257
TF2F	63	FCH-320 -> LSN 0300 A	222
ENO 0000 A/B		FCP-320	257
AT5000 IP/GPRS	61	FCP-320 -> LSN 0300 A	222
GÜ 101-B	66, 67	FCS-320-TM -> FLM-420/4-CON-D	259
MDL-F	62	FCS-320-TM ->:CZM 0004 A	192
UE-F-D/T	65	FCS-320-TP1 -> FLM-420/4-CON-D	260
ENO 0000 B		FCS-320-TP1 ->:CZM 0004 A	193
TF2F	64	FCS-320-TP2 -> FLM-420/4-CON-D	261

FCS-320-TP2 ->:CZM 0004 A	194	WMX-5000 -> FLM-420/4-CON-D	272
FCS-LHD-2 -> FLM-420/4-CON-D	248	<b>F</b>	
FCS-LWM-1 -> FLM-420/4-CON-D	254	FAA-420-RI-DIN ->	
FireRay 50RV/100RV -> FLM-420/4-CON-D	265	DF 1192	151
FIRERAY3000 -> FLM-420/4-CON-D	266, 267, 268	FAA-500	89, 220
FIRERAY3000 ->:CZM 0004 A	195, 196, 197	FAA-MSR 420	90, 221
FIRERAY5000 -> FLM-420/4-CON-D	269, 270	FAA-MSR-420	39, 40, 41
FIRERAY5000 ->:CZM 0004 A	198	FAD-0420	82
FLM-420/4-CON -> LSN 0300 A	212, 213	FAP-425	91, 222, 257
FLM-420-I2-D -> LSN 0300 A	205	FCA-500	58, 128, 129
FLM-420-I2-E/-W -> LSN 0300 A	206	FCA-500-EU	258
FLM-420-I8R1-S -> LSN 0300 A	207	FCH-320	91, 154, 222, 257
FLM-420-NAC-D -> LSN 0300 A	214, 215	FCP-320	91, 154, 222, 257
FLM-420-O1I1-D -> LSN 0300 A	205	FCS-LWM-1	57, 126, 127
FLM-420-O1I1-E -> LSN 0300 A	208	FNM-420-A-BS	87, 218
FLM-420-O8I2-S -> LSN 0300 A	209	FNM-420U-A-BS	87, 218
FLM-420-RHV -> LSN 0300 A	205	MS 400/MS 400 B	91, 154, 222, 257
FLM-420-RLV1-D -> LSN 0300 A	205	FAA-420-RI-ROW ->	
FLM-420-RLV1-E -> LSN 0300 A	210	FAA-MSR-420	39
FLM-I 420-S -> LSN 0300 A	211	FAA-500	
FMC-120 ->:CZM 0004 A	199	FAA-420-RI-DIN	89, 220
FMC-120-DKM -> FLM-420/4-CON-D	255	FAA-500 ->	
FMC-120-EST -> FLM-420/4-CON-D	255	LSN 0300 A	89
FMC-210-... -> LSN 0300 A	216	LSN 0300 A (EOL)	220
FMC-300 -> FLM-420/4-CON-D	256	FAA-500-R ->	
FMC-300 ->:CZM 0004 A	200	LSN 0300 A (EOL)	220
FNM-420-A/-B -> LSN 0300 A	217	FAA-MSR 420	
FNM-420-A-BS -> LSN 0300 A	218, 219	FAA-420-RI-DIN	90, 221
FNM-420U-A/-B -> LSN 0300 A	217	FAA-MSR 420 ->	
FNM-420U-A-BS -> LSN 0300 A	218, 219	63 R	17, 18
FNM-420V-A -> LSN 0300 A	217	837	17, 18
FNX-425U-RFRD ->:LSN 0300 A	241, 242	838	17, 18
FNX-425U-RFWH ->:LSN 0300 A	241, 242	858	17, 18
FNX-425U-WFRD ->:LSN 0300 A	241, 242	GT 40 R	17, 18
FNX-425U-WFWH ->:LSN 0300 A	241, 242	GT 42 R	17, 18
FWI-270 -> LSN 0300 A	243, 244, 245	GT 50 R	17, 18
KMX-5000 -> FLM-420/4-CON-D	272	GT 60 R	17, 18
LSN 0300 A:FNX-425U-RFRD	241, 242	GT 70 R	17, 18
LSN 0300 A:FNX-425U-RFWH	241, 242	GT 70 R 050.01 Ex	17, 18
LSN 0300 A:FNX-425U-WFRD	241, 242	LSN 0300 A	90
LSN 0300 A:FNX-425U-WFWH	241, 242	LSN 0300 A (EOL)	221
MS 400/MS 400 B -> FLM-420/4-CON-D	257	FAA-MSR 420 -> BTS 80 EMB	19, 20
MS 400/MS 400 B -> LSN 0300 A	222	FAA-MSR 420 -> BTS 80 FLB	19, 20
N4387A -> FLM-420/4-CON-D	262	FAA-MSR 420 -> TS 73 EMF	19, 20
OSID -> FLM-420/4-CON-D	250	FAA-MSR 420 -> TS 93 EMF	19, 20
Reset action	204	FAA-MSR 420 -> TS 93 GSR/EMF1	19, 20
thefirebeam -> FLM-420/4-CON-D	249		
Typ K -> FLM-420/4-CON-D	271		
UniVario -> FLM-420/4-CON-D	272		

FAA-MSR 420 -> TS 93 GSR/EMF2	19, 20	FCA-500-EU ->	
FAA-MSR-420		FLM-420/4-CON-D	128, 129
ED 100	15, 16	FLM-420/4-CON-D (EOL)	258
ED 250	15, 16	FCH-320	
FAA-420-RI-DIN	39, 40, 41	FAA-420-RI-DIN	91, 154, 222, 257
FAA-420-RI-ROW	39	FCH-320 ->	
Slimdrive EMD-F	21, 22	FLM-420/4-CON-D	154
Slimdrive EMD-F-IS	21, 22	FLM-420/4-CON-D (EOL)	257
TS 4000 E	23, 24	LSN 0300 A	91
TS 4000 EFS	23, 24	LSN 0300 A (EOL)	222
TS 4000 E-IS	23, 24	FCP-320	
TS 5000 E	23, 24	FAA-420-RI-DIN	91, 154, 222, 257
TS 5000 E-IS	23, 24	FCP-320 ->	
TS 5000 E-ISM	23, 24	FLM-420/4-CON-D	154
TS 550 E	23, 24	FLM-420/4-CON-D (EOL)	257
TSA 160 NT F	23, 24	LSN 0300 A	91
TSA 160 NT F-IS	23, 24	LSN 0300 A (EOL)	222
TSA 160 NT F-IS/TS	23, 24	FCP-500 ->	
FAD-0420		FLM-420/4-CON-D	128, 129
FAA-420-RI-DIN	82	FCS-320-TM ->	
FAD-420-HS-EN ->		CZM 0004 A	54
LSN 0300 A	82, 83	FCS-LWM-1	54
FAP-425		FLM-420/4-CON-D	130
FAA-420-RI-DIN	91, 222, 257	FLM-420/4-CON-D (EOL)	259
FAP-425 ->		FCS-320-TP1 ->	
FLM-420/4-CON-D	154	CZM 0004 A	55
FLM-420/4-CON-D (EOL)	257	FLM-420/4-CON-D	131, 133
LSN 0300 A	91	FLM-420/4-CON-D (EOL)	260
LSN 0300 A (EOL)	221, 222	FCS-320-TP2 ->	
FAP-520 ->		FLM-420/4-CON-D	132
LSN 0300 A	89	FLM-420/4-CON-D (EOL)	261
LSN 0300 A (EOL)	220	FCS-320-TP2->	
FAS-420 ->		CZM 0004 A	56
LSN 0300 A	84	FCS-LHD-2 ->	
LSN 0300 A (EOL)	223, 224	FLM-420/4-CON-D	125
FAS-420-TM ->		FLM-420/4-CON-D (EOL)	248
LSN 0300 A	85	FCS-LHD-2EN ->	
LSN 0300 A (EOL)	225, 226, 227, 228	FLM-420-I8R1-S	158, 159
FAT2002RE ->		FCS-LWM-1	
FPE-5000-UGM	123	FAA-420-RI-DIN	57, 126, 127
FBF 100 LSN ->		FCS-LWM-1 ->	
LSN 0300 A	96	CZM 0004 A	57
LSN 0300 A (EOL)	229, 230, 231, 232	FLM-420/4-CON-D	126, 127
FCA-500		FLM-420/4-CON-D (EOL)	254
FAA-420-RI-DIN	58, 128, 129	FireRay 100 RV ->	
FCA-500 ->		CZM 0004 A	45
CZM 0004 A	58	FLM-420/4-CON-D	138, 144
FCA-500-EU		FireRay 50 RV ->	
FAA-420-RI-DIN	258	CZM 0004 A	45

FLM-420/4-CON-D	138, 144	FCS-320-TP1 (EOL)	260
Fireray 50RV/100RV ->		FCS-320-TP2	132
FLM-420/4-CON-D (EOL)	265	FCS-320-TP2 (EOL)	261
FIRERAY3000 ->		FCS-LHD-2	125
CZM 0004 A	46, 47, 48	FCS-LHD-2 (EOL)	248
FLM-420/4-CON-D	139, 140, 141, 145, 146	FCS-LWM-1	126, 127
FLM-420/4-CON-D (EOL)	266, 267, 268	FCS-LWM-1 (EOL)	254
FIRERAY5000 ->		Fireray 100 RV	138, 144
CZM 0004 A	49, 50, 51	Fireray 50 RV	138, 144
FLM-420/4-CON-D	142, 143, 147, 148	Fireray 50RV/100RV (EOL)	265
FLM-420/4-CON-D (EOL)	269, 270	FIRERAY3000	139, 140, 141, 145, 146
FLM-420/4-CON ->		FIRERAY3000 (EOL)	266, 267, 268
LSN 0300 A	95	FIRERAY5000	142, 143, 147, 148
LSN 0300 A (EOL)	212, 213	FIRERAY5000 (EOL)	269, 270
FLM-420/4-CON-D		FMC-120-DKM	156
016519	134, 135, 136, 137	FMC-120-DKM (EOL)	255
016519 (EOL)	263, 264	FMC-120-EST (EOL)	255
016589	134, 135, 136, 137	FMC-300	152
016589 (EOL)	263, 264	FMC-300 (EOL)	256
2014/2 Ex	155	KMX-5000 (EOL)	272
2014/2 GLU-Ex	155	MS 400/MS 400 B	154
ADW 535-1 (EOL)	246	MS 400/MS 400 B (EOL)	257
ADW 535-2 (EOL)	247	N4387A	153
ALARMLINE II	125	N4387A (EOL)	262
ALARMLINE II (EOL)	248	NO-Relay	157
ASD 532 (EOL)	251	OSID (EOL)	250
ASD 535-1 (EOL)	252	thefirebeam (EOL)	249
ASD 535-2 (EOL)	253	TSZ 0400	36
DC1192, SB3	149, 150	Typ K (EOL)	271
DC1192, SB3 (EOL)	271	UniVario (EOL)	272
DF 1192	151	WMX-5000 (EOL)	272
DF1101-A-EX	149, 150	FLM-420-I2-D ->	
DF1101-A-EX (EOL)	271	FPP-3000	13
DM 1103B-X	149, 150	LSN 0300 A	69
DM 1103B-X (EOL)	271	LSN 0300 A (EOL)	205
DO1101-A-EX	149, 150	FLM-420-I2-E ->	
DO1101-A-EX (EOL)	271	FPP-3000	13
FAP-425	154	FLM-420-I2-E/-W	
FAP-425 (EOL)	257	TSZ 0400	37
FCA-500-EU	128, 129	FLM-420-I2-E/-W ->	
FCA-500-EU (EOL)	258	LSN 0300 A	70
FCH-320	154	LSN 0300 A (EOL)	206
FCH-320 (EOL)	257	FLM-420-I2-W ->	
FCP-320	154	FPP-3000	13
FCP-320 (EOL)	257	FLM-420-I8R1-S	
FCP-500	128, 129	FCS-LHD-2EN	158, 159
FCS-320-TM	130	FLM-420-I8R1-S ->	
FCS-320-TM (EOL)	259	FPP-3000	13
FCS-320-TP1	131, 133	LSN 0300 A	71

LSN 0300 A (EOL)	207	TS 5000 E	33, 34
FLM-420-NAC-D		TS 5000 E-IS	33, 34
FNM-320	170, 171	TS 5000 E-ISM	33, 34
FNS-320	168, 169	TS 550 E	33, 34
FPP-5000	43	TS 73 EMF	29, 30
PA 10	162, 163	TS 93 EMF	29, 30
PA 5	160, 161	TS 93 GSR/EMF1	29, 30
PB 2005	166, 167	TS 93 GSR/EMF2	29, 30
PY X-M-10-SSM R	164, 165	TSA 160 NT F	33, 34
PY X-M-10-SSM W	164, 165	TSA 160 NT F-IS	33, 34
ROLP-R-LX	170, 171	TSA 160 NT F-IS/TS	33, 34
ROLP-W-LX	170, 171	FLM-420-RHV ->	
SOL-LX	168, 169	63 R	27, 28
FLM-420-NAC-D ->		837	27, 28
FPP-3000	14	838	27, 28
FPP-5000	44	858	27, 28
LSN 0300 A	74, 75	GT 40 R	27, 28
LSN 0300 A (EOL)	214, 215	GT 42 R	27, 28
LSN 300 A, BCM 0000 B	76	GT 50 R	27, 28
FLM-420-O1I1-D ->		GT 60 R	27, 28
LSN 0300 A	78, 79	GT 70 R	27, 28
LSN 0300 A (EOL)	205	GT 70 R 050.01 Ex	27, 28
FLM-420-O1I1-E		LSN 0300 A	69
TSZ 0400	38	LSN 0300 A (EOL)	205
FLM-420-O1I1-E ->		FLM-420-RLE-S	
LSN 0300 A	80	LA	184
LSN 0300 A (EOL)	208	FLM-420-RLE-S ->	
FLM-420-O8I2-S ->		LSN 0300 A	77
FPP-3000	13	FLM-420-RLV1-D ->	
LSN 0300 A	72, 73	LSN 0300 A	69
LSN 0300 A (EOL)	209	LSN 0300 A (EOL)	205
FLM-420-RHV		FLM-420-RLV1-E	
ADW 535-1	178, 179	Plena	185
ADW 535-2	180, 181	FLM-420-RLV1-E ->	
ASD 532	176, 177	LSN 0300 A	70
ASD 535-1	172, 173	LSN 0300 A (EOL)	210
ASD 535-2	174, 175	FLM-420-RLV8-S	
ASD 535-3	172, 173	Plena	186
ASD 535-4	174, 175	FLM-420-RLV8-S ->	
BTS EMB	29, 30	LSN 0300 A	81
BTS FLB	29, 30	FLM-I 420-S ->	
ED 100	25, 26	LSN 0300 A	69
ED 250	25, 26	LSN 0300 A (EOL)	211
FRAY-ONE-EN	182, 183	FMC-120->	
Slimdrive EMD-F	31, 32	CZM 0004 A	59
Slimdrive EMD-F-IS	31, 32	FMC-120-DKM ->	
TS 4000 E	33, 34	FLM-420/4-CON-D	156
TS 4000 EFS	33, 34	FLM-420/4-CON-D (EOL)	255
TS 4000 E-IS	33, 34	FMC-120-EST ->	

FLM-420/4-CON-D (EOL)	255	FMF-FBF-FAT ->FMF-ADP-FBF	187
FMC-210-... ->		FMF-FIBS ->	
LSN 0300 A	100	FPE-5000-UGM	122, 123
LSN 0300 A (EOL)	216	IOS 0020 A	121
FMC-210-IP66-R ->		FNM-320 ->	
LSN 0300 A	101	FLM-420-NAC-D	170, 171
FMC-300 ->		NZM 0002 A	114, 115
FLM-420/4-CON-D	152	FNM-420-A/-B ->	
FLM-420/4-CON-D (EOL)	256	LSN 0300 A	86
FMC-300->		LSN 0300 A (EOL)	217
CZM 0004 A	60	FNM-420-A-BS	
FMC-420RW ->		FAA-420-RI-DIN	87, 218
LSN 0300 A	102	FNM-420-A-BS ->	
FMF-ADP ->		LSN 0300 A	87, 88
FPE-5000-UGM	122, 123	LSN 0300 A (EOL)	218, 219
IOS 0020 A	121	FNM-420U-A/-B ->	
FMF-ADP-FAT		LSN 0300 A	86
FMF-FAT	187	LSN 0300 A (EOL)	217
FMF-FBF-FAT	187	FNM-420U-A-BS	
FMF-FAT ->		FAA-420-RI-DIN	87, 218
FPE-5000-UGM	122	FNM-420U-A-BS ->	
IOS 0020 A	121	LSN 0300 A	87, 88
FMF-FAT ->FMF-ADP-FBF	187	LSN 0300 A (EOL)	218, 219
FMF-FBF-FAT ->		FNM-420V-A ->	
FPE-5000-UGM	122, 123	LSN 0300 A	86
IOS 0020 A	121	LSN 0300 A (EOL)	217
		FNS-320 ->	
		FLM-420-NAC-D	168, 169
		NZM 0002 A	111, 112, 113
		FNS-P400RTH ->	
		RMH 0002 A	119
		FNX-425U-RFRD ->	
		LSN 0300 A	98, 99
		LSN 0300 A (EOL)	241, 242
		FNX-425U-RFWH ->	
		LSN 0300 A	98, 99
		LSN 0300 A (EOL)	241, 242
		FNX-425U-WFRD ->	
		LSN 0300 A	98, 99
		LSN 0300 A (EOL)	241, 242
		FNX-425U-WFWH ->	
		LSN 0300 A	98, 99
		LSN 0300 A (EOL)	241, 242
		FPE-5000-UGM	
		FAT2002RE	123
		FMF-ADP	122, 123
		FMF-FAT	122
		FMF-FBF-FAT	122, 123
		FMF-FIBS	122, 123

FPP-3000			<b>I</b>	
FLM-420-I2-D	13		IOS 0020 A	
FLM-420-I2-E	13		FMF-ADP	121
FLM-420-I2-W	13		FMF-FAT	121
FLM-420-I8R1-S	13		FMF-FBF-FAT	121
FLM-420-NAC-D	14		FMF-FIBS	121
FLM-420-O8I2-S	13		Plena	120
FPP-5000			<b>K</b>	
FLM-420-NAC-D	44		KMX-5000 ->	
FPP-5000 ->			FLM-420/4-CON-D (EOL)	272
FLM-420-NAC-D	43			
FPP-5000-TI				
BCM-0000-B	11			
FPP-5000-TI13				
BCM-0000-B	12			
FRAY-ONE-EN ->				
FLM-420-RHV	182, 183			
FWI-270 ->				
LSN 0300 A	105			
LSN 0300 A (EOL)	243, 244, 245			
<b>G</b>				
GSME-L3 ->				
LSN 0300 A	92			
GT 40 R ->				
FAA-MSR 420	17, 18			
FLM-420-RHV	27, 28			
GT 42 R ->				
FAA-MSR 420	17, 18			
FLM-420-RHV	27, 28			
GT 50 R ->				
FAA-MSR 420	17, 18			
FLM-420-RHV	27, 28			
GT 60 R ->				
FAA-MSR 420	17, 18			
FLM-420-RHV	27, 28			
GT 63 R ->				
FAA-MSR 420	17, 18			
FLM-420-RHV	27, 28			
GT 70 R ->				
FAA-MSR 420	17, 18			
FLM-420-RHV	27, 28			
GT 70 R 050.01 Ex ->				
FAA-MSR 420	17, 18			
FLM-420-RHV	27, 28			
GÜ 101-B ->				
ENO 0000 A/B	66, 67			

<b>L</b>				
LA ->				
FLM-420-RLE-S	184		FLM-420-RLV1-D	69
LSN 0300 A (FLM-420-RLE-S)	97		FLM-420-RLV1-D (EOL)	205
LSN 0300 A			FLM-420-RLV1-E	70
ATB 420 LSNi	93		FLM-420-RLV1-E (EOL)	210
ATB 420 LSNi (EOL)	233, 234, 235, 236		FLM-420-RLV8-S	81
ATG 420 LSNi	94		FLM-I 420-S	69
ATG 420 LSNi (EOL)	237, 238, 239, 240		FLM-I 420-S (EOL)	211
C31B	103, 104		FMC-210-...	100
FAA-500	89		FMC-210-... (EOL)	216
FAA-500 (EOL)	220		FMC-210-IP66-R	101
FAA-500-R (EOL)	220		FMC-420RW	102
FAA-MSR 420	90		FNM-420-A/-B	86
FAA-MSR 420 (EOL)	221		FNM-420-A/-B (EOL)	217
FAD-420-HS-EN	82, 83		FNM-420-A-BS	87, 88
FAP-425	91		FNM-420-A-BS (EOL)	218, 219
FAP-425 (EOL)	221, 222		FNM-420U-A/-B	86
FAP-520	89		FNM-420U-A/-B (EOL)	217
FAP-520 (EOL)	220		FNM-420U-A-BS	87, 88
FAS-420	84		FNM-420U-A-BS (EOL)	218, 219
FAS-420 (EOL)	223, 224		FNM-420V-A	86
FAS-420-TM	85		FNM-420V-A (EOL)	217
FAS-420-TM (EOL)	225, 226, 227, 228		FNX-425U-RFRD	98, 99
FBF 100 LSN	96		FNX-425U-RFRD (EOL)	241, 242
FBF 100 LSN (EOL)	229, 230, 231, 232		FNX-425U-RFWH	98, 99
FCH-320	91		FNX-425U-RFWH (EOL)	241, 242
FCH-320 (EOL)	222		FNX-425U-WFRD	98, 99
FCP-320	91		FNX-425U-WFRD (EOL)	241, 242
FCP-320 (EOL)	222		FNX-425U-WFWH	98, 99
FLM-420/4-CON	95		FNX-425U-WFWH (EOL)	241, 242
FLM-420/4-CON (EOL)	212, 213		FWI-270	105
FLM-420-I2-D	69		FWI-270 (EOL)	243, 244, 245
FLM-420-I2-D (EOL)	205		GSME-L3	92
FLM-420-I2-E/-W	70		LA (FLM-420-RLE-S)	97
FLM-420-I2-E/-W (EOL)	206		MS 400/MS 400 B	91
FLM-420-I8R1-S	71		MS 400/MS 400 B (EOL)	222
FLM-420-I8R1-S (EOL)	207			
FLM-420-NAC-D	74, 75		<b>M</b>	
FLM-420-NAC-D (EOL)	214, 215		MDL-F ->	
FLM-420-O1I1-D	78, 79		ENO 0000 A/B	62
FLM-420-O1I1-D (EOL)	205		MS 400	
FLM-420-O1I1-E	80		TSZ 0400 (FCP-O320 / FCH-T320 FSA)	35
FLM-420-O1I1-E (EOL)	208		MS 400/MS 400 B	
FLM-420-O8I2-S	72, 73		FAA-420-RI-DIN	91, 154, 222, 257
FLM-420-O8I2-S (EOL)	209		MS 400/MS 400 B ->	
FLM-420-RHV	69		FLM-420/4-CON-D	154
FLM-420-RHV (EOL)	205		FLM-420/4-CON-D (EOL)	257
FLM-420-RLE-S	77		LSN 0300 A	91
			LSN 0300 A (EOL)	222



**N**

N4387A ->	
FLM-420/4-CON-D	153
FLM-420/4-CON-D (EOL)	262
NO-Relay ->	
FLM-420/4-CON-D	157
NZM 0002 A	
FNM-320	114, 115
FNS-320	111, 112, 113
NZM 0002 A	110
PA 10	108, 109
PA 5	106, 107
PB 2005	116, 117, 118
ROLP-W-LX	114, 115
SOL-LX	111, 112, 113
NZM 0002 A ->	
NZM 0002 A	110

**O**

OSID ->	
FLM-420/4-CON-D (EOL)	250

**P**

PA 10 ->	
FLM-420-NAC-D	162, 163
NZM 0002 A	108, 109
PA 5 ->	
FLM-420-NAC-D	160, 161
NZM 0002 A	106, 107
PB 2005 ->	
FLM-420-NAC-D	166, 167
NZM 0002 A	116, 117, 118
Plena ->	
FLM-420-RLV1-E	185
FLM-420-RLV8-S	186
IOS 0020 A	120
PY X-M-10-SSM R ->	
FLM-420-NAC-D	164, 165
PY X-M-10-SSM W ->	
FLM-420-NAC-D	164, 165

**R**

Redundancy	
ENO	67
LSN 0300 A	97
NZM 0002 A	110
Panel controller	97

Reset action	204
RMH 0002 A	
FNS-P400RTH	119
ROLP-R-LX ->	
FLM-420-NAC-D	170, 171
ROLP-W-LX ->	
FLM-420-NAC-D	170, 171
NZM 0002 A	114, 115

**S**

Slimdrive EMD-F ->	
FAA-MSR-420	21, 22
FLM-420-RHV	31, 32
Slimdrive EMD-F-IS ->	
FAA-MSR-420	21, 22
FLM-420-RHV	31, 32
SOL-LX ->	
FLM-420-NAC-D	168, 169
NZM 0002 A	111, 112, 113

<b>T</b>			
TF2F ->			
ENO 0000 A	63	FLM-420-RHV	33, 34
ENO 0000 B	64	TSZ 0400 ->	
thefirebeam ->		FLM-420/4-CON-D	36
FLM-420/4-CON-D (EOL)	249	FLM-420-I2-E/-W	37
TS 4000 E ->		FLM-420-O1I1-E	38
FAA-MSR-420	23, 24	MS 400 (FCP-O320 / FCH-T320 FSA)	35
FLM-420-RHV	33, 34	Typ K ->	
TS 4000 EFS ->		FLM-420/4-CON-D (EOL)	271
FAA-MSR-420	23, 24	<b>U</b>	
FLM-420-RHV	33, 34	UE-F-D/T ->	
TS 4000 E-IS ->		ENO 0000 A/B	65
FAA-MSR-420	23	UniVario ->	
FLM-420-RHV	33, 34	FLM-420/4-CON-D (EOL)	272
TS 4000 E-IS->		<b>W</b>	
FAA-MSR-420	24	WMX-5000 ->	
TS 5000 E ->		FLM-420/4-CON-D (EOL)	272
FAA-MSR-420	23, 24		
FLM-420-RHV	33, 34		
TS 5000 E-IS ->			
FAA-MSR-420	23, 24		
FLM-420-RHV	33, 34		
TS 5000 E-ISM ->			
FAA-MSR-420	23, 24		
FLM-420-RHV	33, 34		
TS 550 E ->			
FAA-MSR-420	23, 24		
FLM-420-RHV	33, 34		
TS 73 EMF ->			
FAA-MSR 420	19, 20		
FLM-420-RHV	29, 30		
TS 93 EMF ->			
FAA-MSR 420	19, 20		
FLM-420-RHV	29, 30		
TS 93 GSR/EMF1 ->			
FAA-MSR 420	19, 20		
FLM-420-RHV	29, 30		
TS 93 GSR/EMF2 ->			
FAA-MSR 420	19, 20		
FLM-420-RHV	29, 30		
TSA 160 NT F ->			
FAA-MSR-420	23, 24		
FLM-420-RHV	33, 34		
TSA 160 NT F-IS ->			
FAA-MSR-420	23, 24		
FLM-420-RHV	33, 34		
TSA 160 NT F-IS/TS ->			
FAA-MSR-420	23, 24		







**Bosch Sicherheitssysteme GmbH**

Robert-Bosch-Ring 5

85630 Grasbrunn

Germany

**[www.boschsecurity.com](http://www.boschsecurity.com)**

© Bosch Sicherheitssysteme GmbH, 2023

**Building solutions for a better life.**

202307120846