

016519, 016589 IR3 Flame Detector

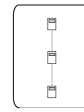

ELS

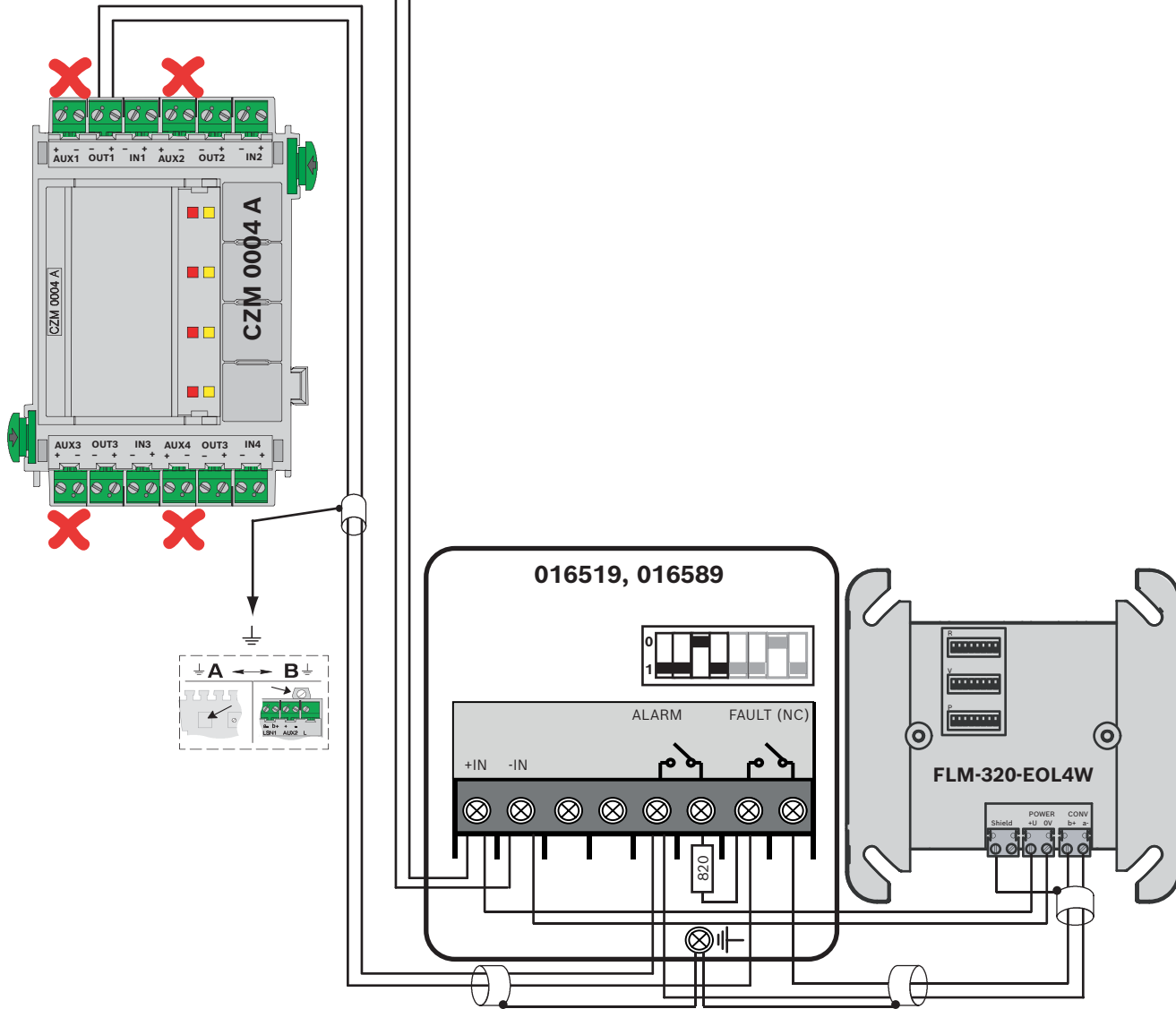

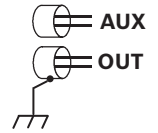
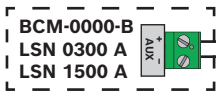
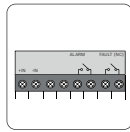

016519, 016589 IR3 Flame Detector

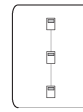

BCM-0000-B
LSN 0300 A
LSN 1500 A

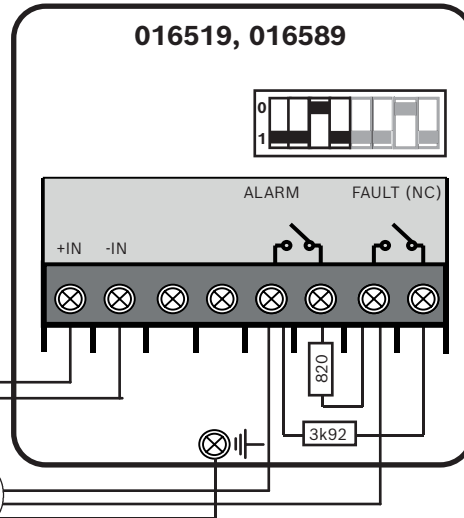
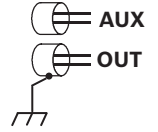
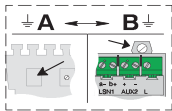
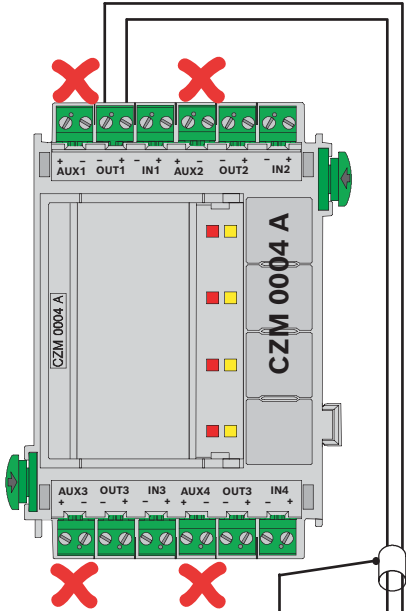

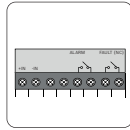

016519, 016589 IR3 Flame Detector



ELS

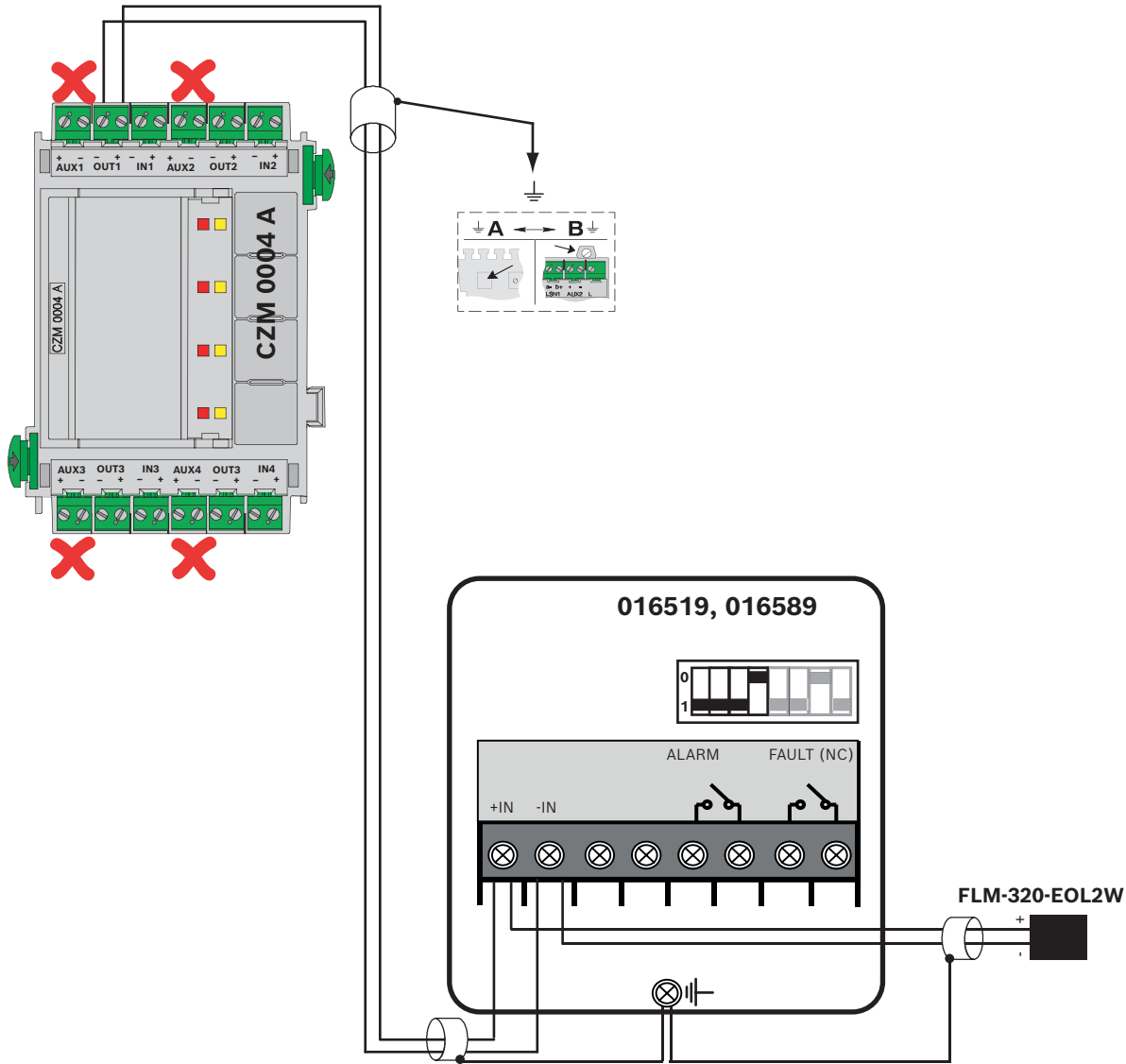

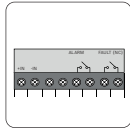

016519, 016589 IR3 Flame Detector

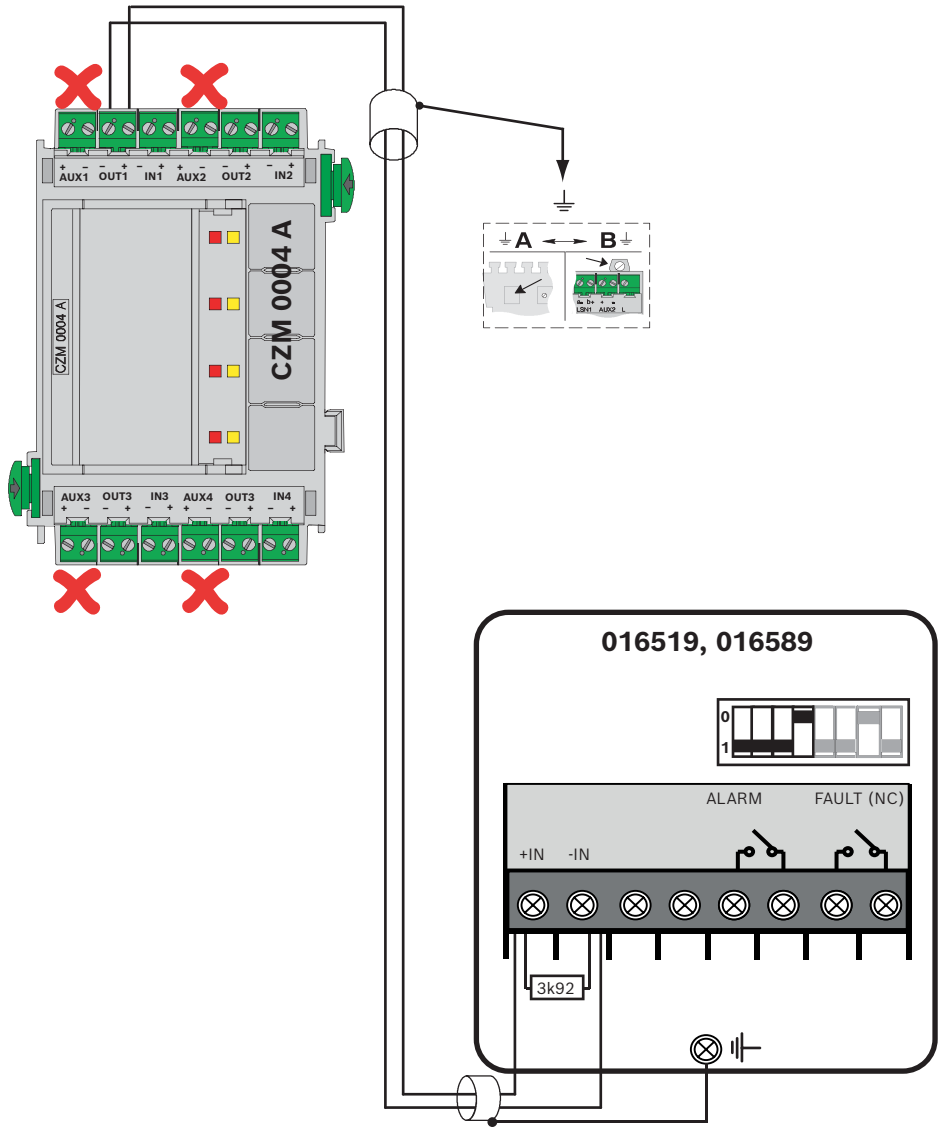
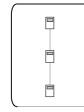



FCA-500-EU
 FCP-O 500
 FCP-O 500-P
 FCP-OC 500
 FCP-OC 500-P

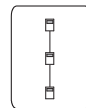

ELS

BCM-0000-B
 LSN 0300 A
 LSN 1500 A

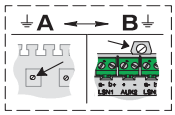
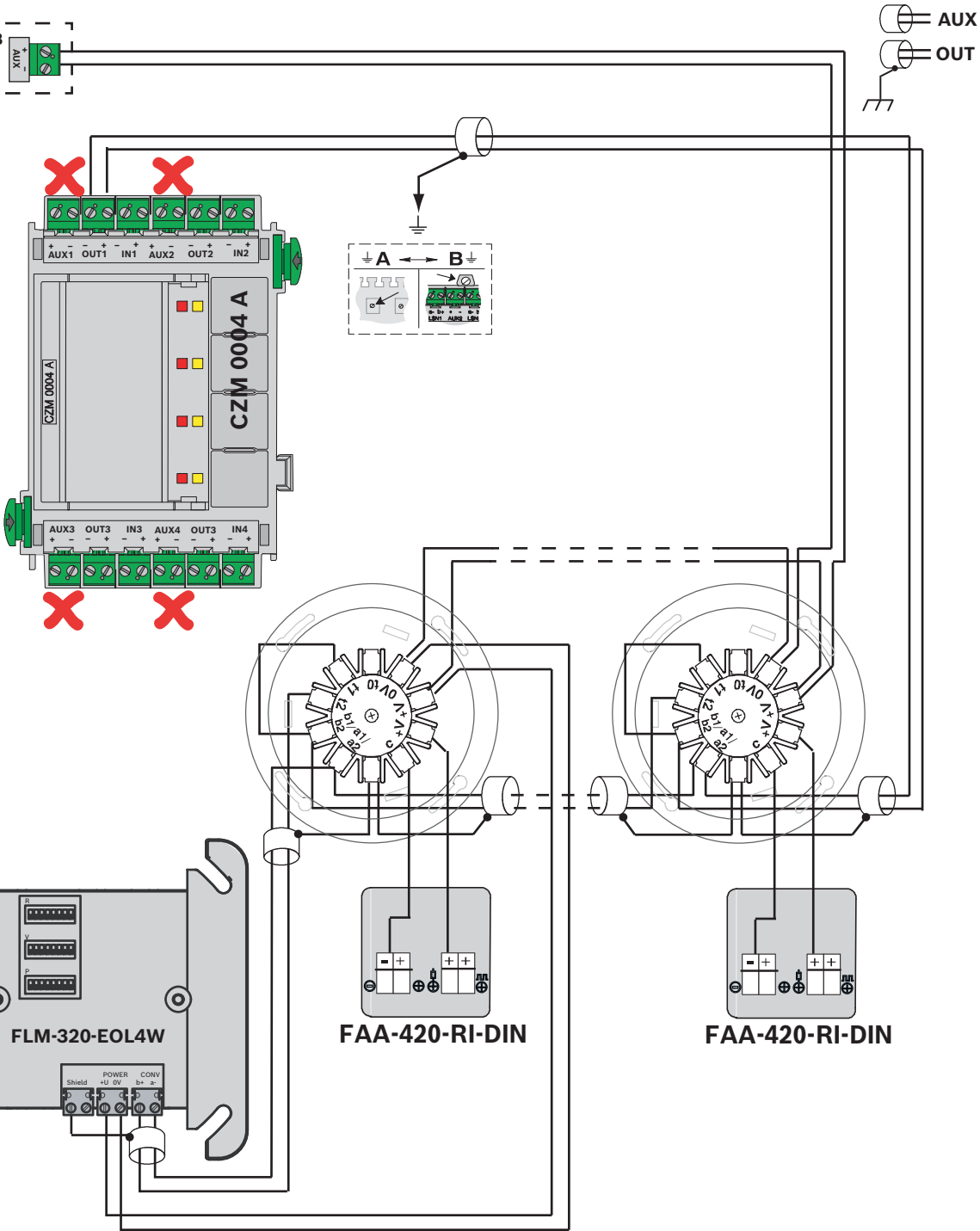

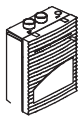

FCS-320-TM Series

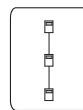

BCM-0000-B
LSN 0300 A
LSN 1500 A

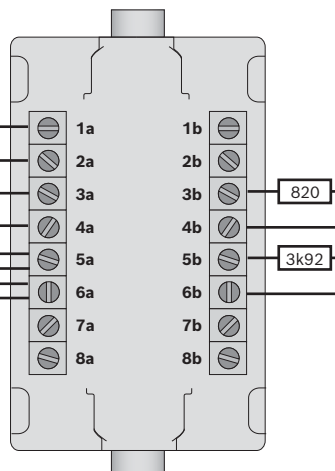
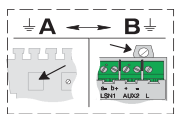
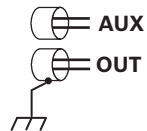
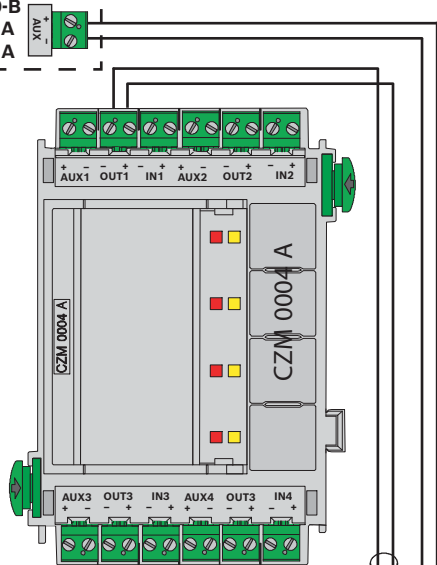

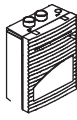

FCS-320-TM Series

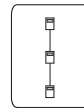

ELS

BCM-0000-B
LSN 0300 A
LSN 1500 A

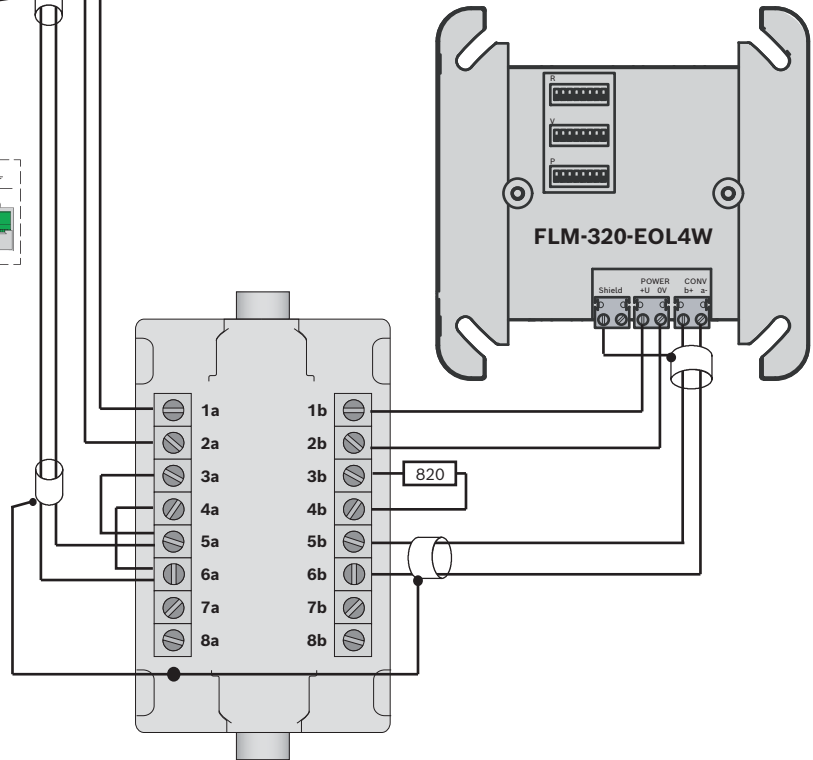
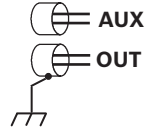
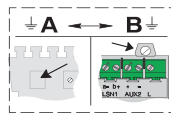
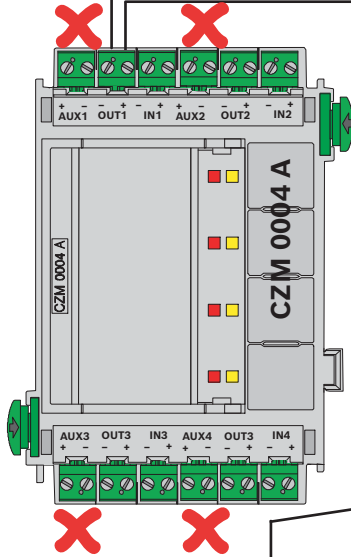

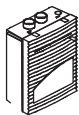

FCS-320-TP1

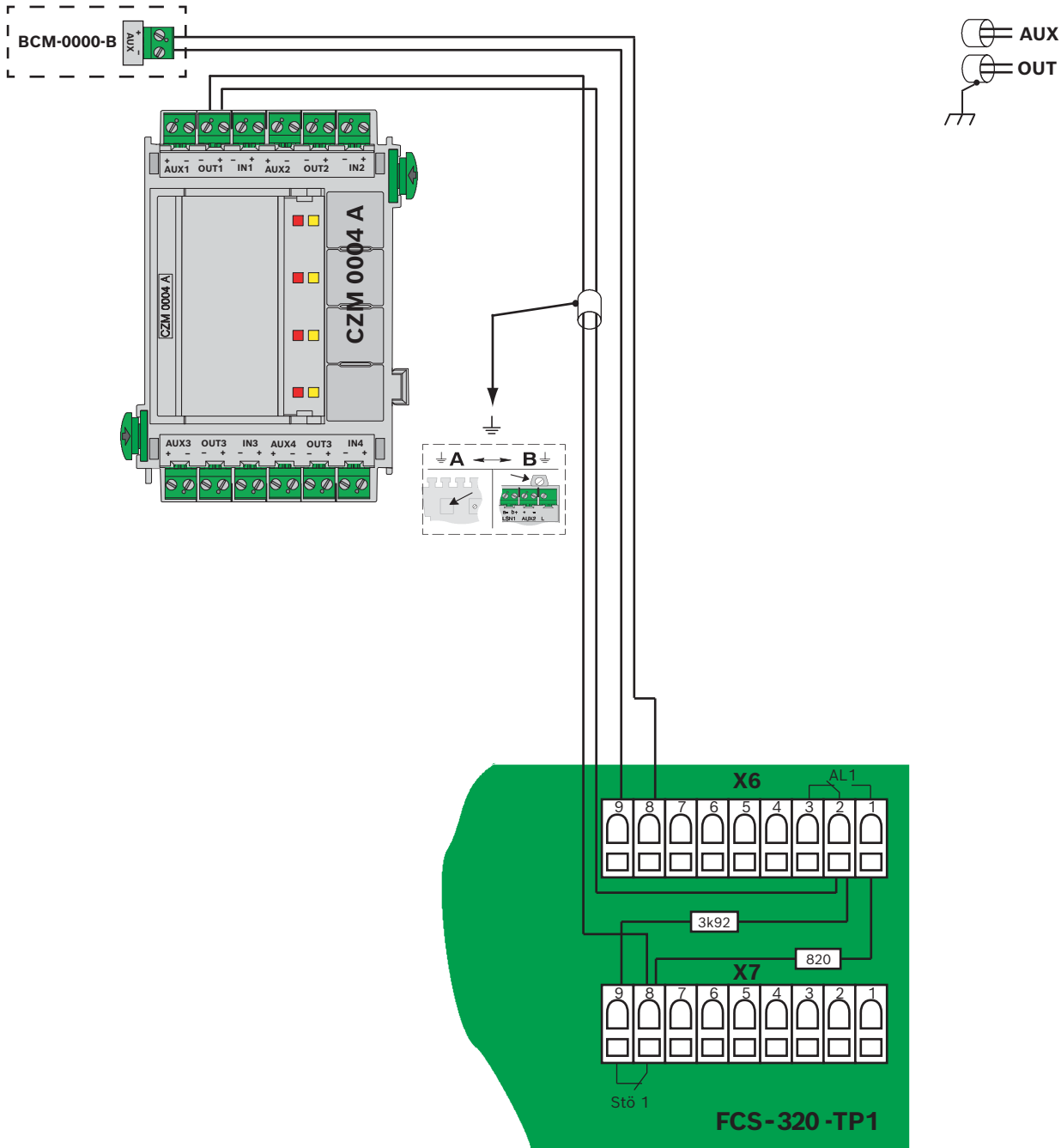
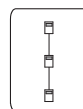

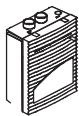

FCS-320-TP1

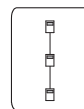

ELS

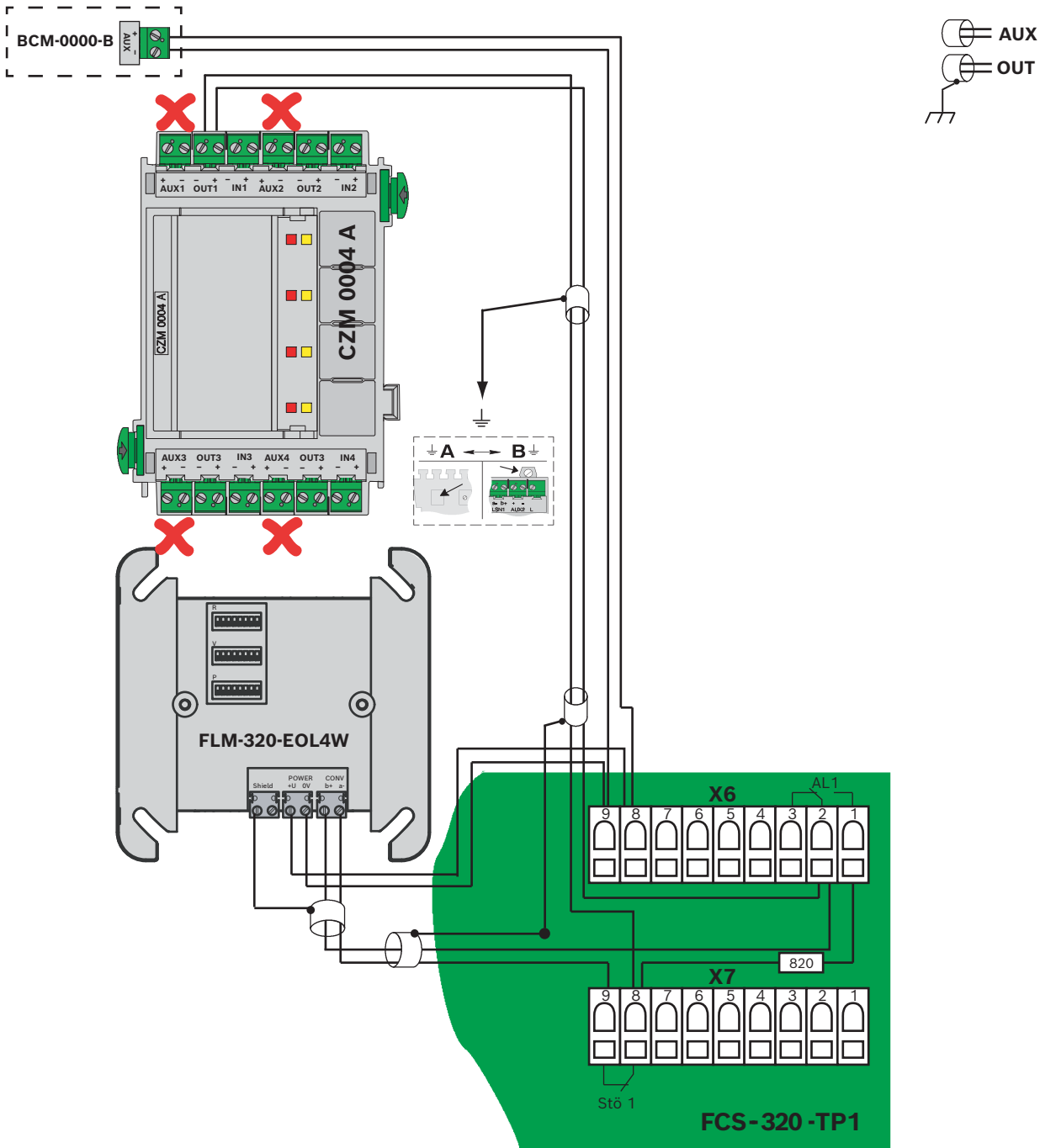

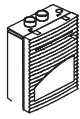

FCS-320-TP2

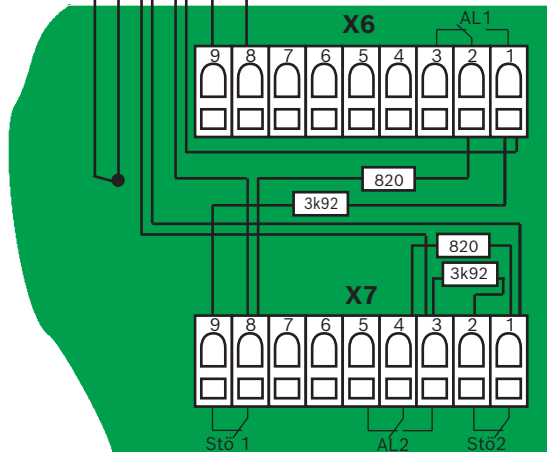
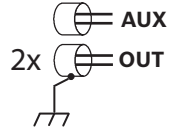
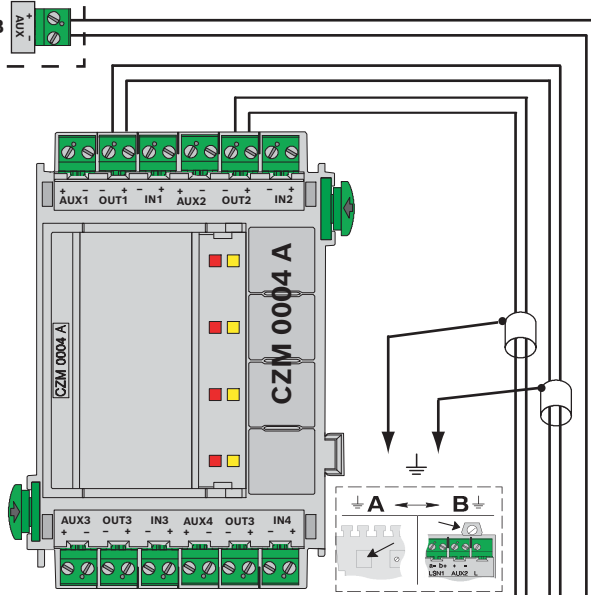
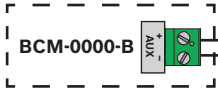
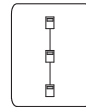

FCS - 320 - TP2

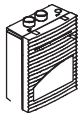

FCS-320-TP2

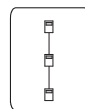

ELS

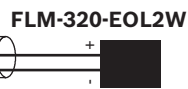
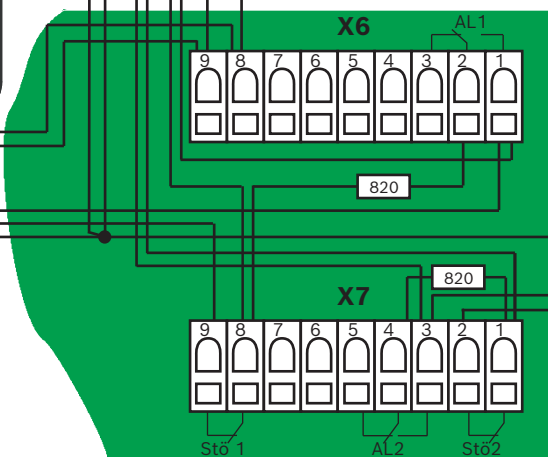
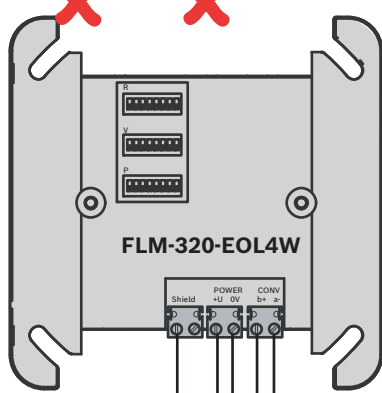
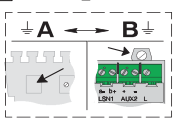
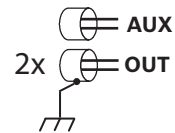
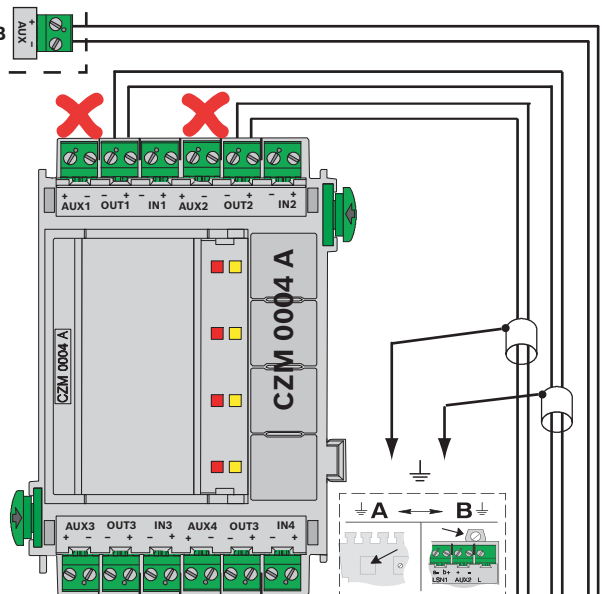
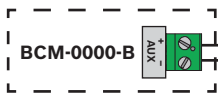

FCS-320-TP2

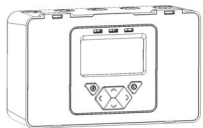

FIRERAY3000

1 x

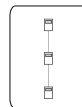

BCM-0000-B
LSN 0300 A
LSN 1500 A

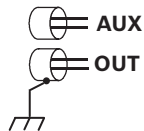
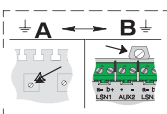
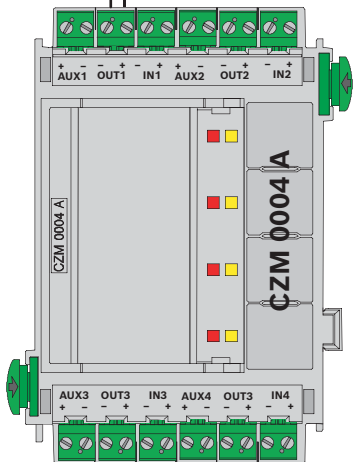

Reset action

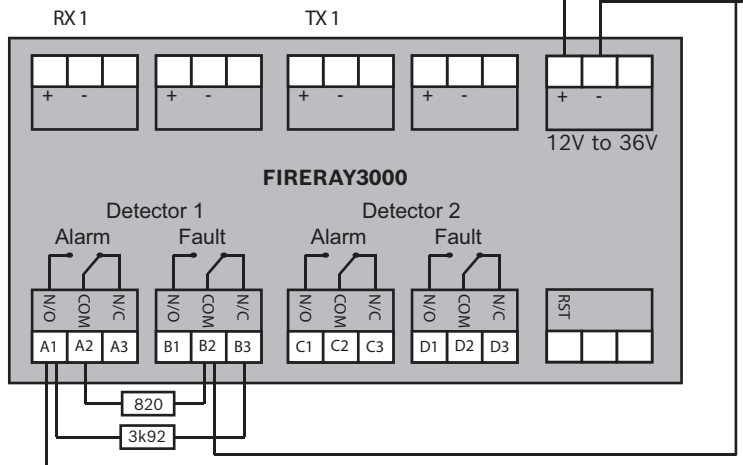

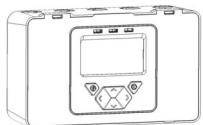

FIRERAY3000

1 x

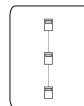

ELW

BCM-0000-B

LSN 0300 A

LSN 1500 A

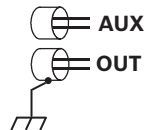
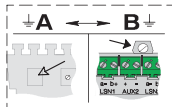
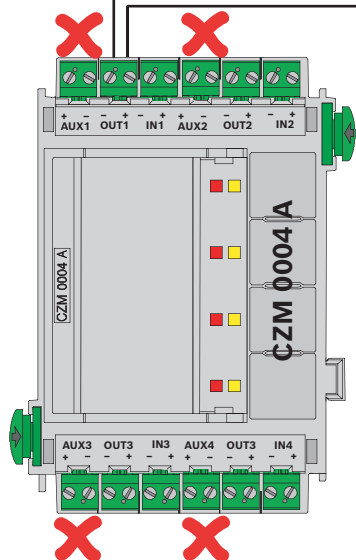

Reset action

RX 1

TX 1

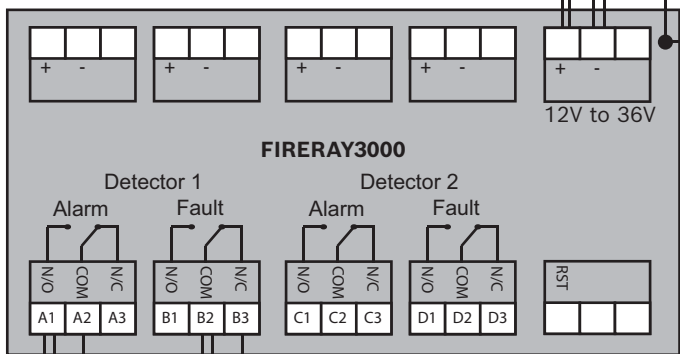

12V to 36V

820

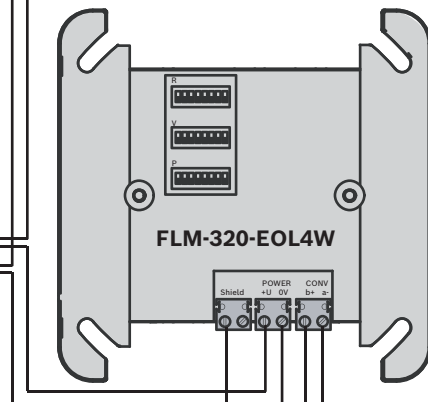

FLM-320-EOL4W

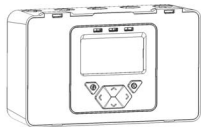

FIRERAY3000

2 x OUT1

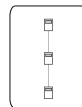

BCM-0000-B
LSN 0300 A
LSN 1500 A

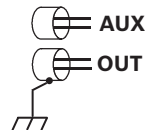
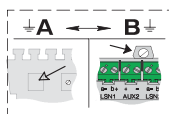
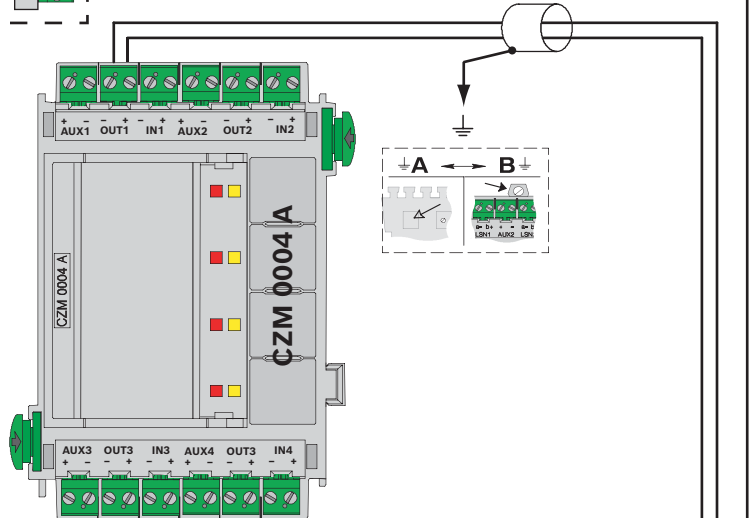

Reset action

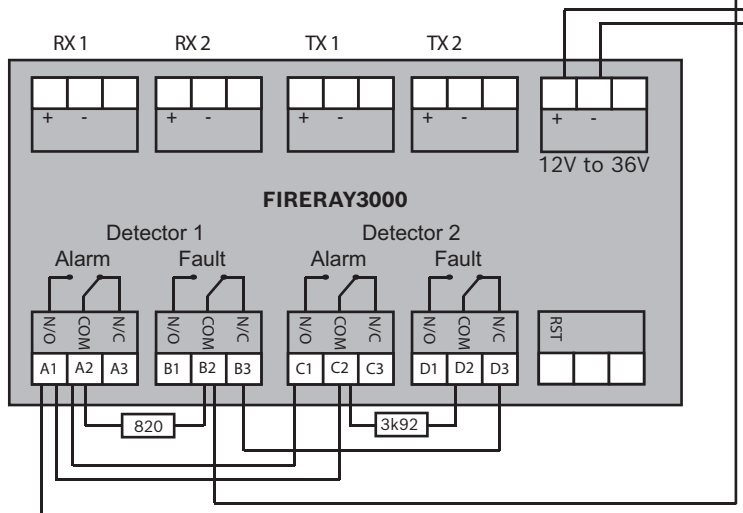

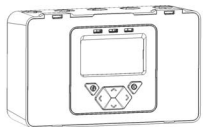

FIRERAY3000

2 x OUT1

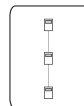

ELS

BCM-0000-B
LSN 0300 A
LSN 1500 A

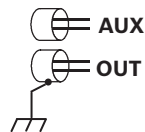
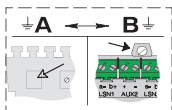
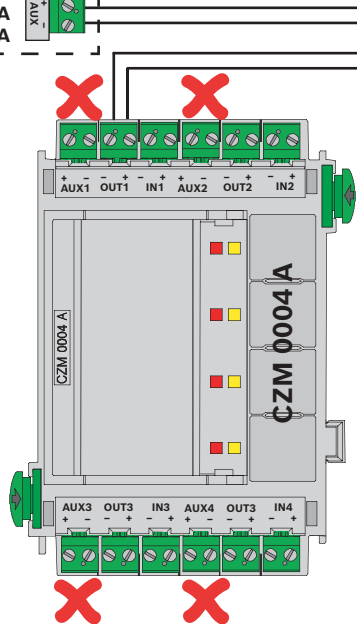

Reset action

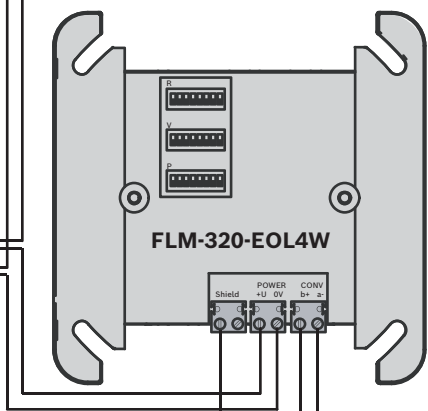
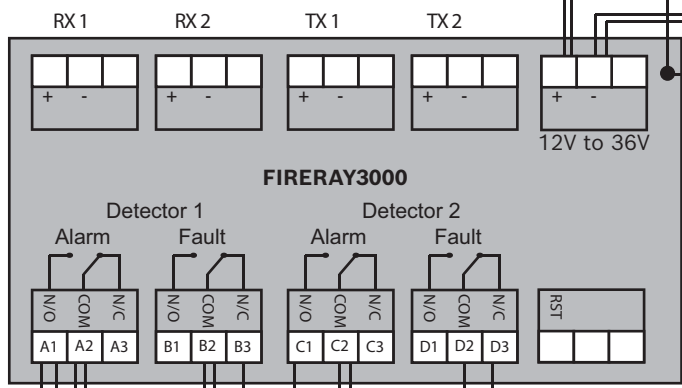

820

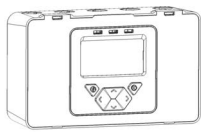

FIRERAY3000

2 x OUT1+2

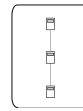

BCM-0000-B
LSN 0300 A
LSN 1500 A

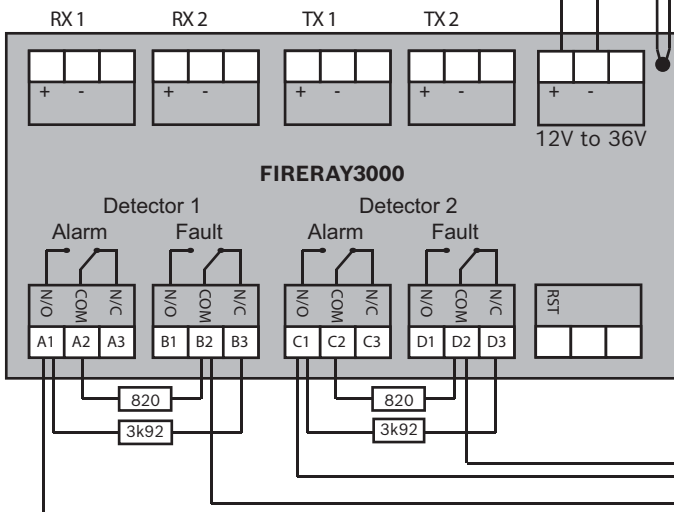
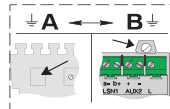
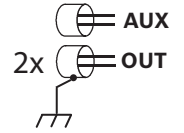
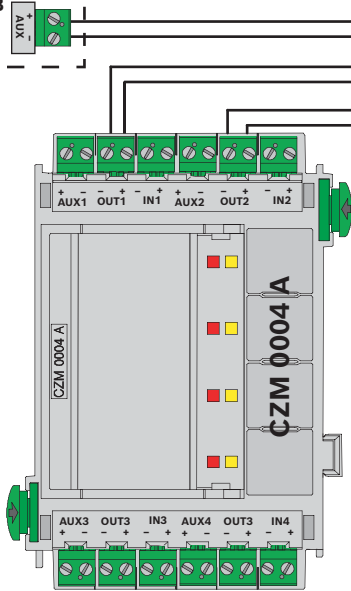

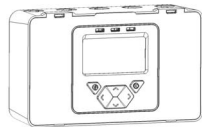

FIRERAY3000

2 x OUT1+2

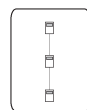

ELS

BCM-0000-B
LSN 0300 A
LSN 1500 A

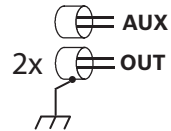
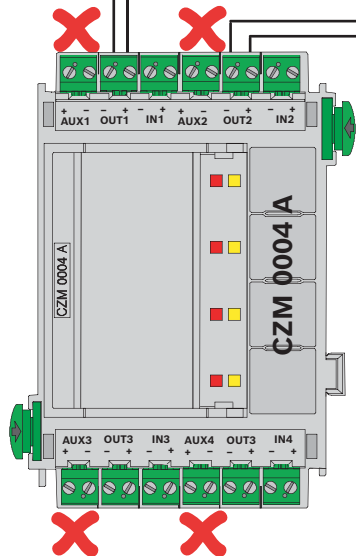

Reset action

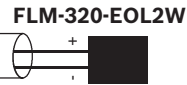
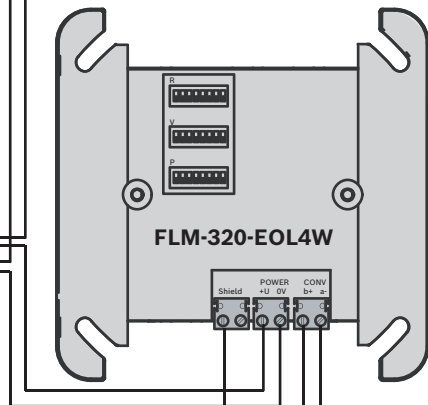
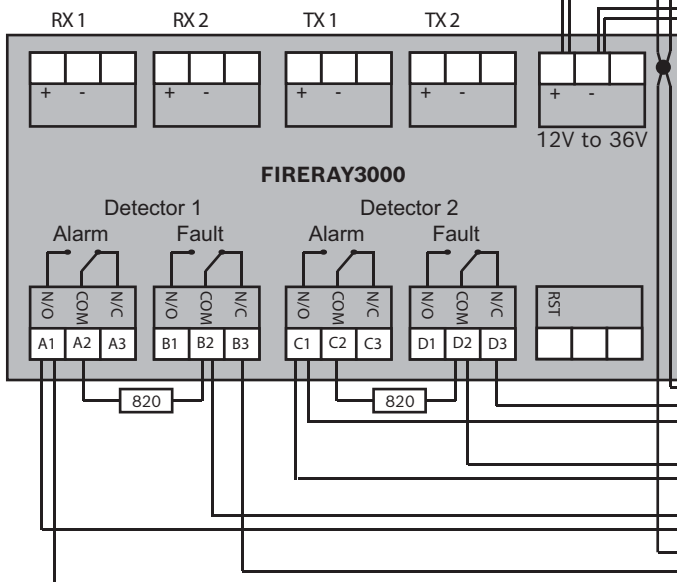
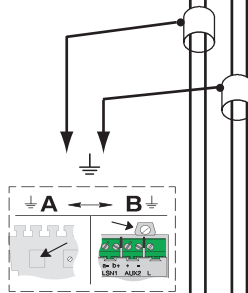



FIRERAY5000

1 x

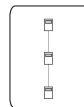

BCM-0000-B
LSN 0300 A
LSN 1500 A

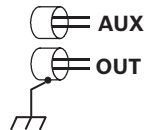
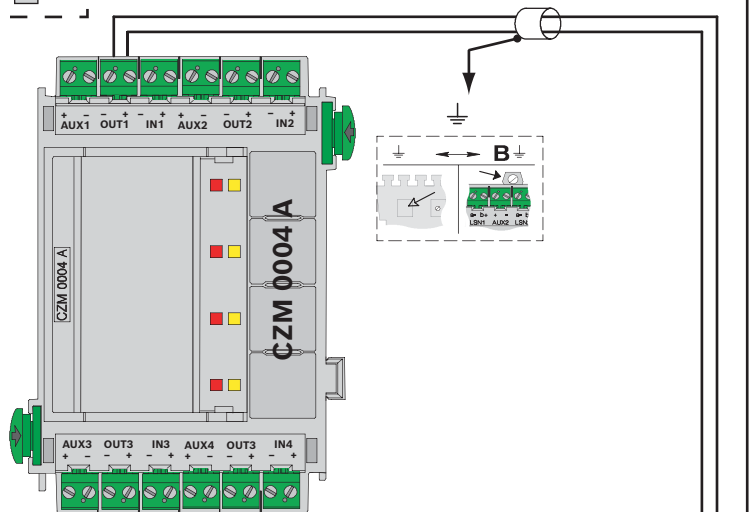

Reset action

Detector 1

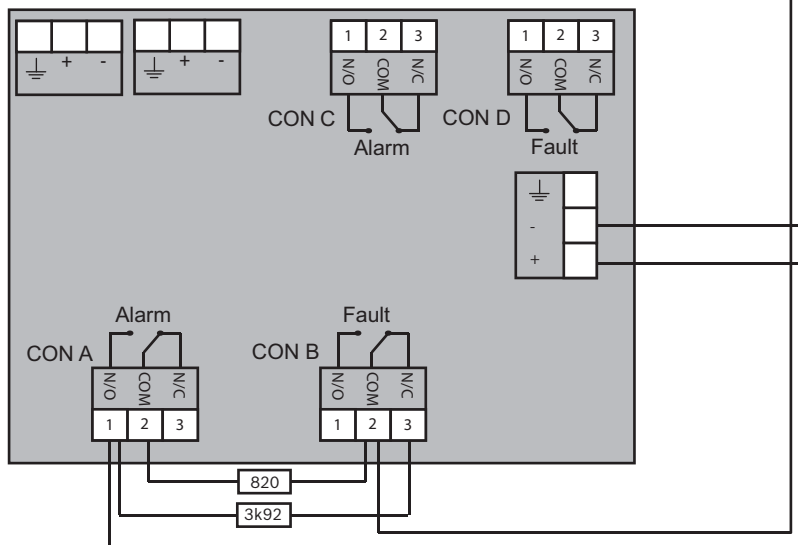



FIRERAY5000

1 x

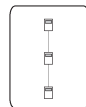

ELW

BCM-0000-B
LSN 0300 A
LSN 1500 A

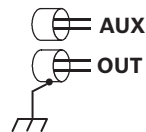
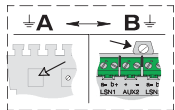
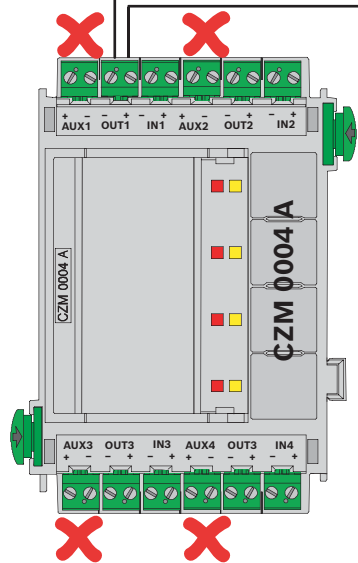

Reset action

Detector 1

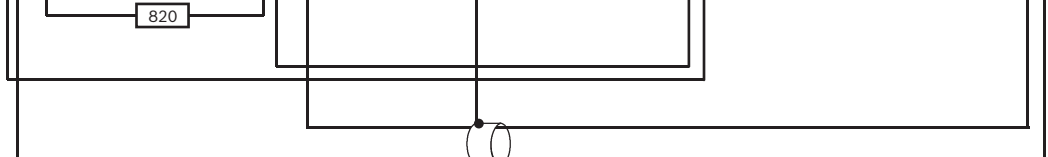
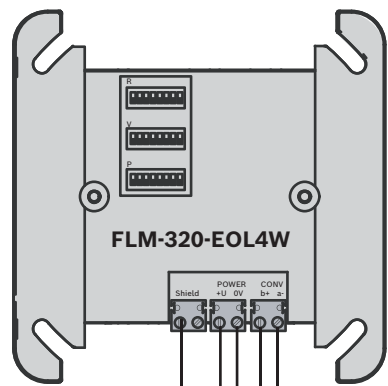
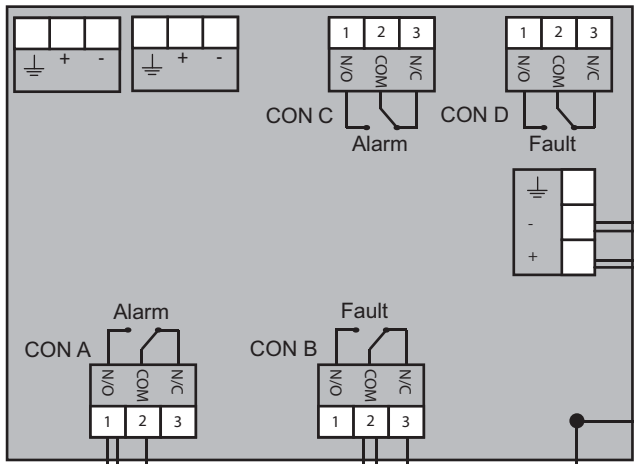



FIRERAY5000

2 x OUT1

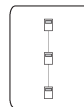

BCM-0000-B
LSN 0300 A
LSN 1500 A

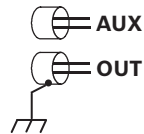
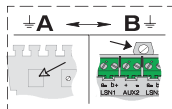
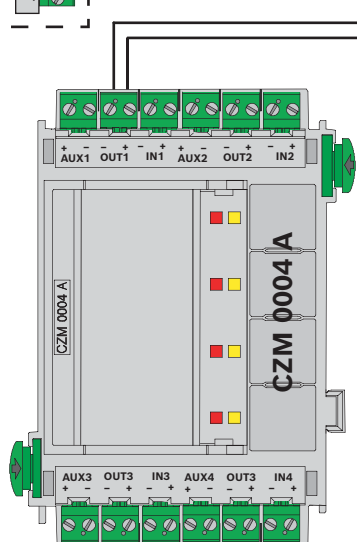

Reset action

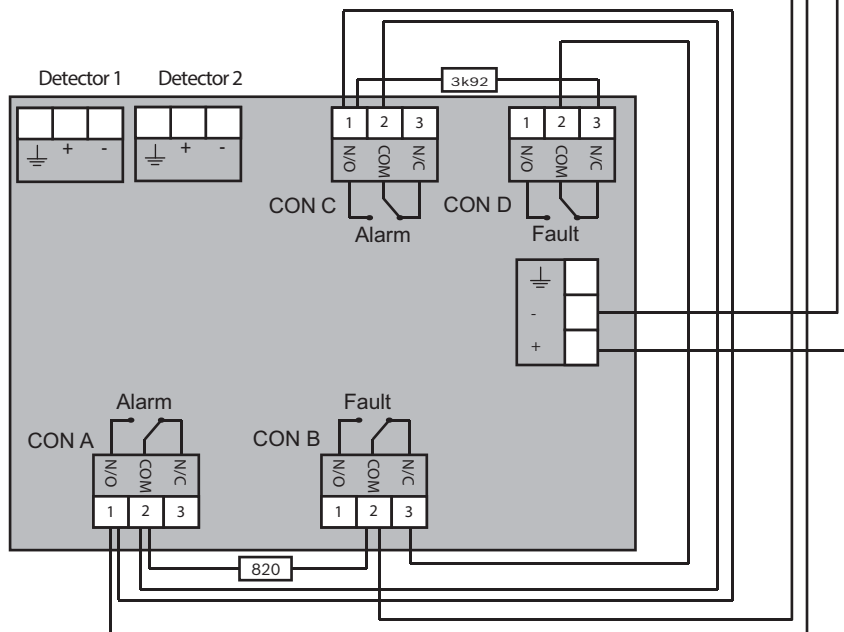

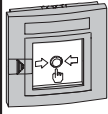
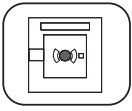

FMC-120-DKM-G-R
FMC-120-DKM-H-R
FMC-120-DKM-G-B
FMC-120-DKM-H-B
FMC-120-DKM-G-Y

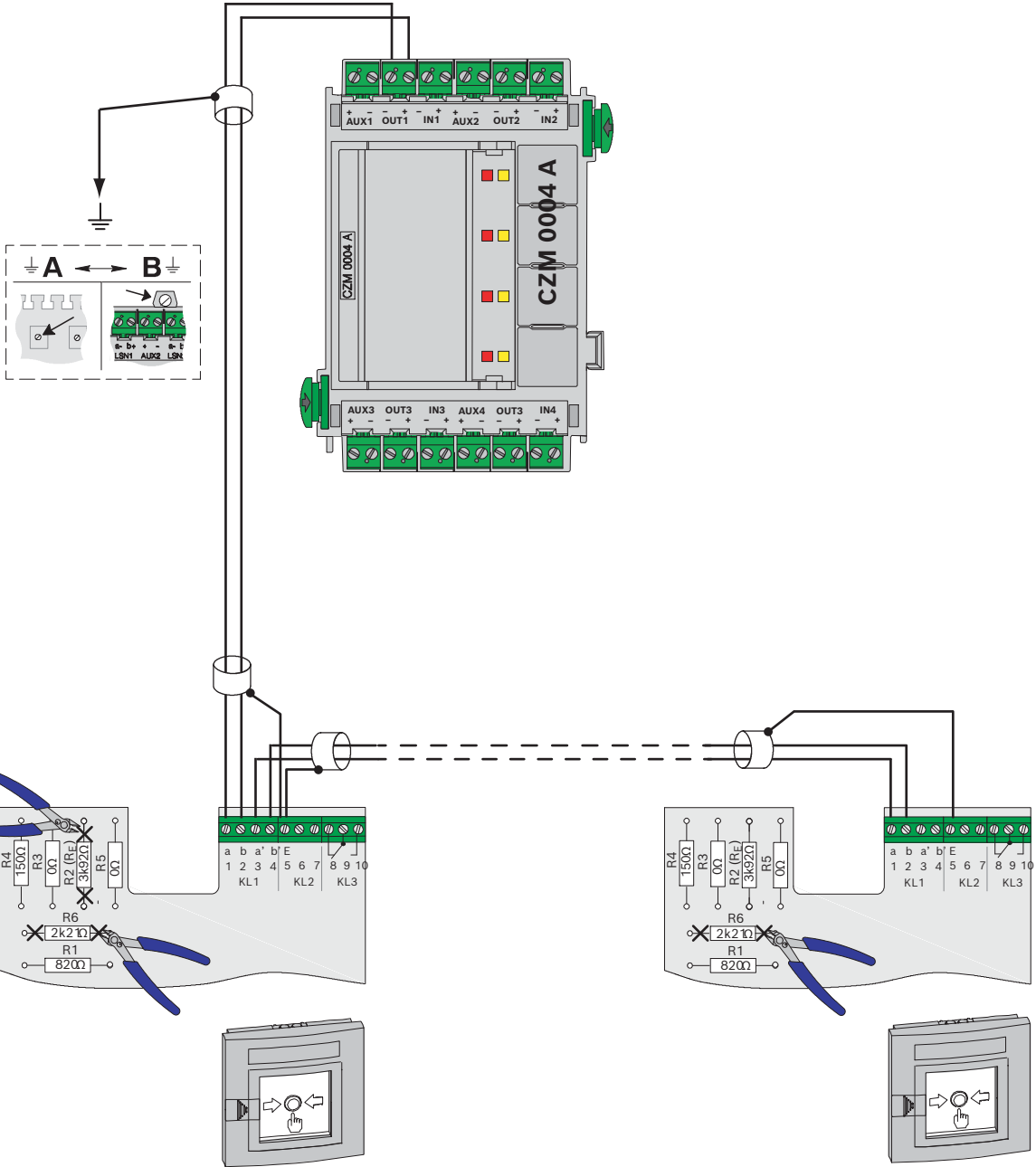
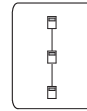

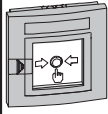
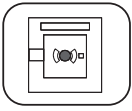

FMC-120-DKM-G-R
FMC-120-DKM-H-R
FMC-120-DKM-G-B
FMC-120-DKM-H-B
FMC-120-DKM-G-Y

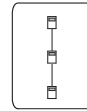

ELS

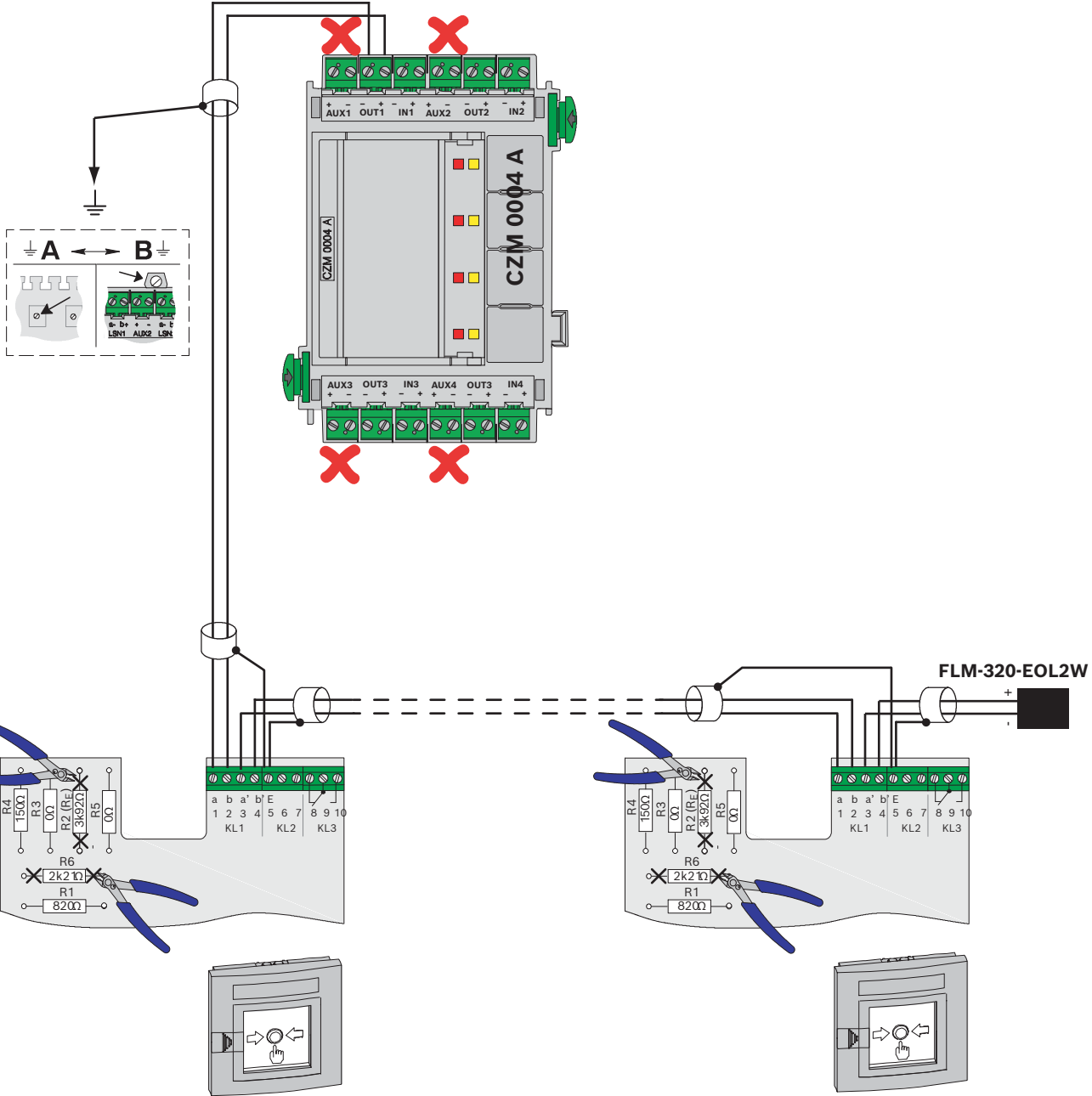

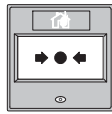
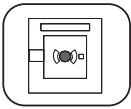

FMC-300RW-GSGBU
FMC-300RW-GSGRD
FMC-300RW-GSRRD
FMC-300RW-GSGYE
FMC-300RW-GSRYE

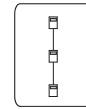

ELS

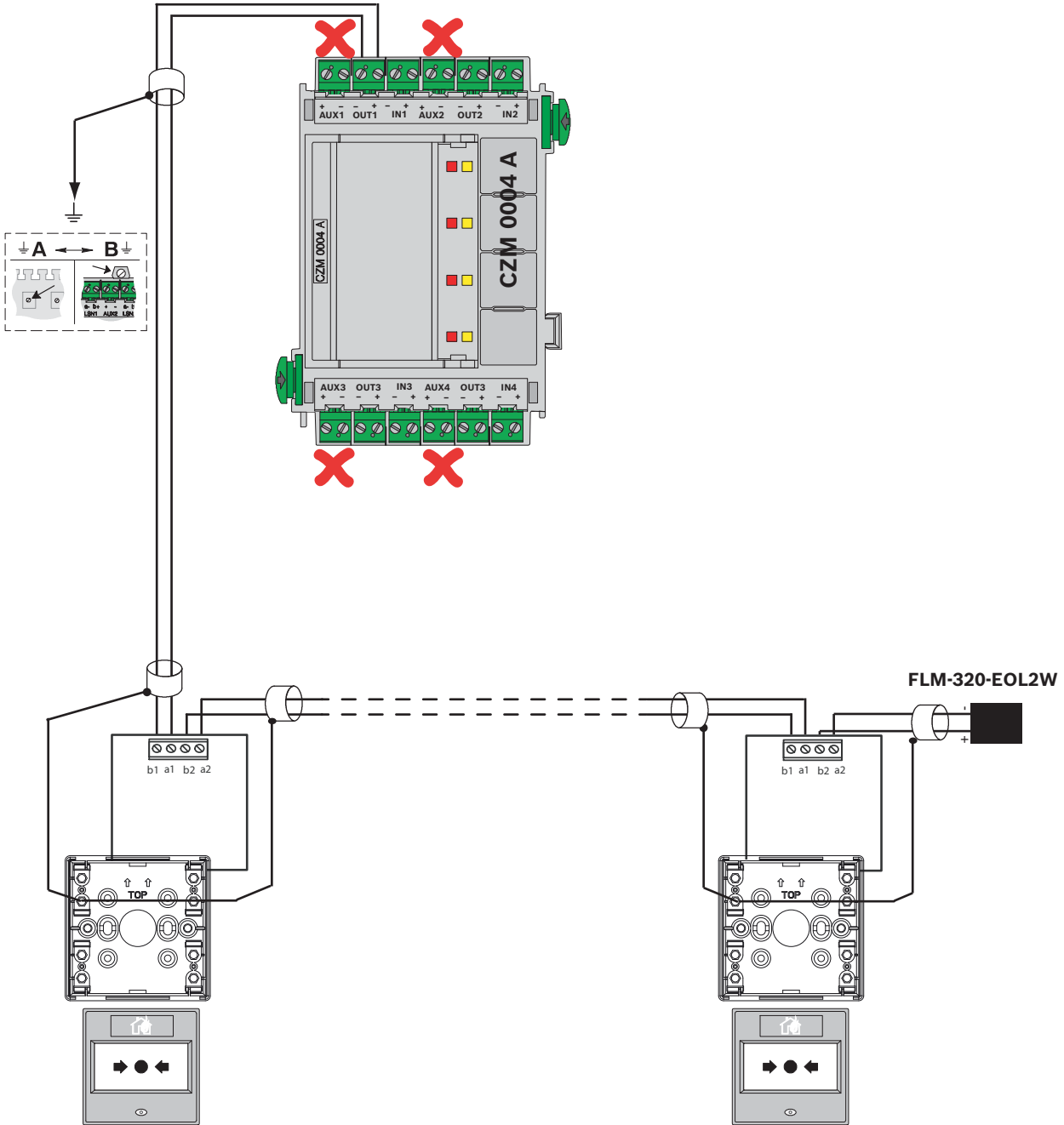

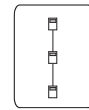
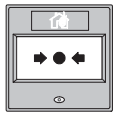

FMC-300RW-GSGBU
FMC-300RW-GSGRD
FMC-300RW-GSRRD
FMC-300RW-GSGYE
FMC-300RW-GSRYE

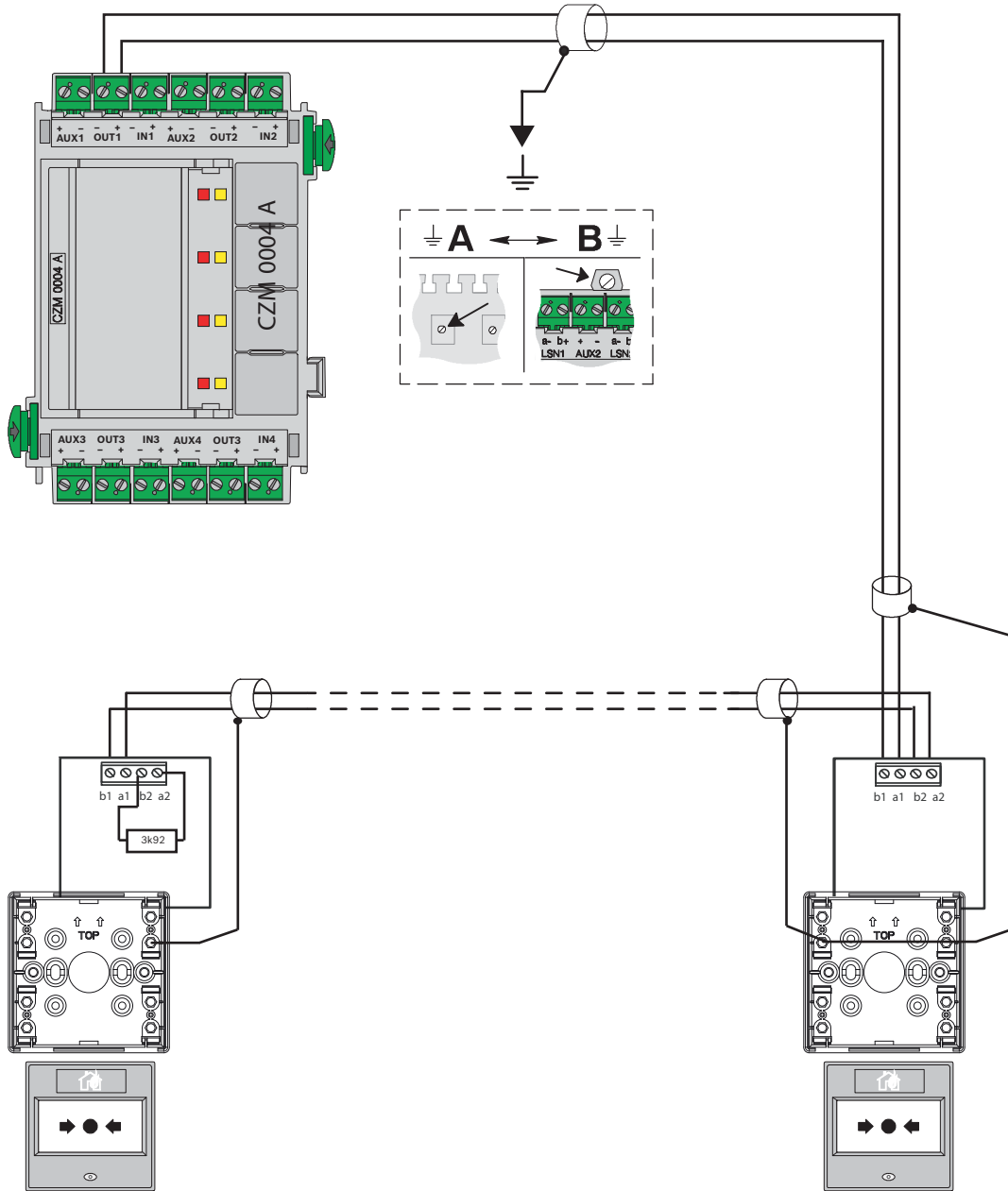

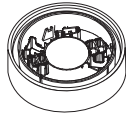

MSS 300-WH-EC
FCH-T320, FCH-T320-FSA,
FCH-T320-R470
FCP-O320, FCP-O320-R470
FCP-OC320, FCP-OC320-R470
FCP-OT320, FCP-OT320-R470

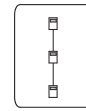

BCM-0000-B
LSN 0300 A
LSN 1500 A

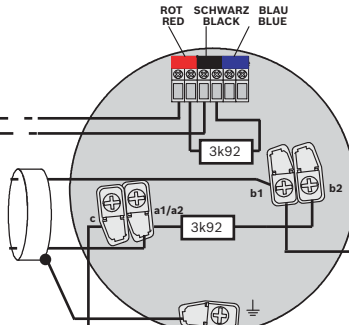
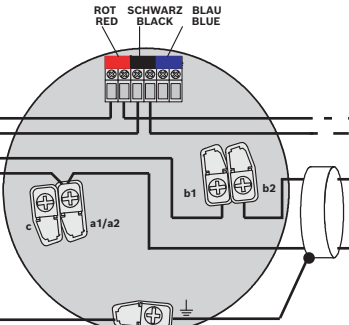
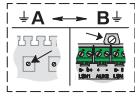
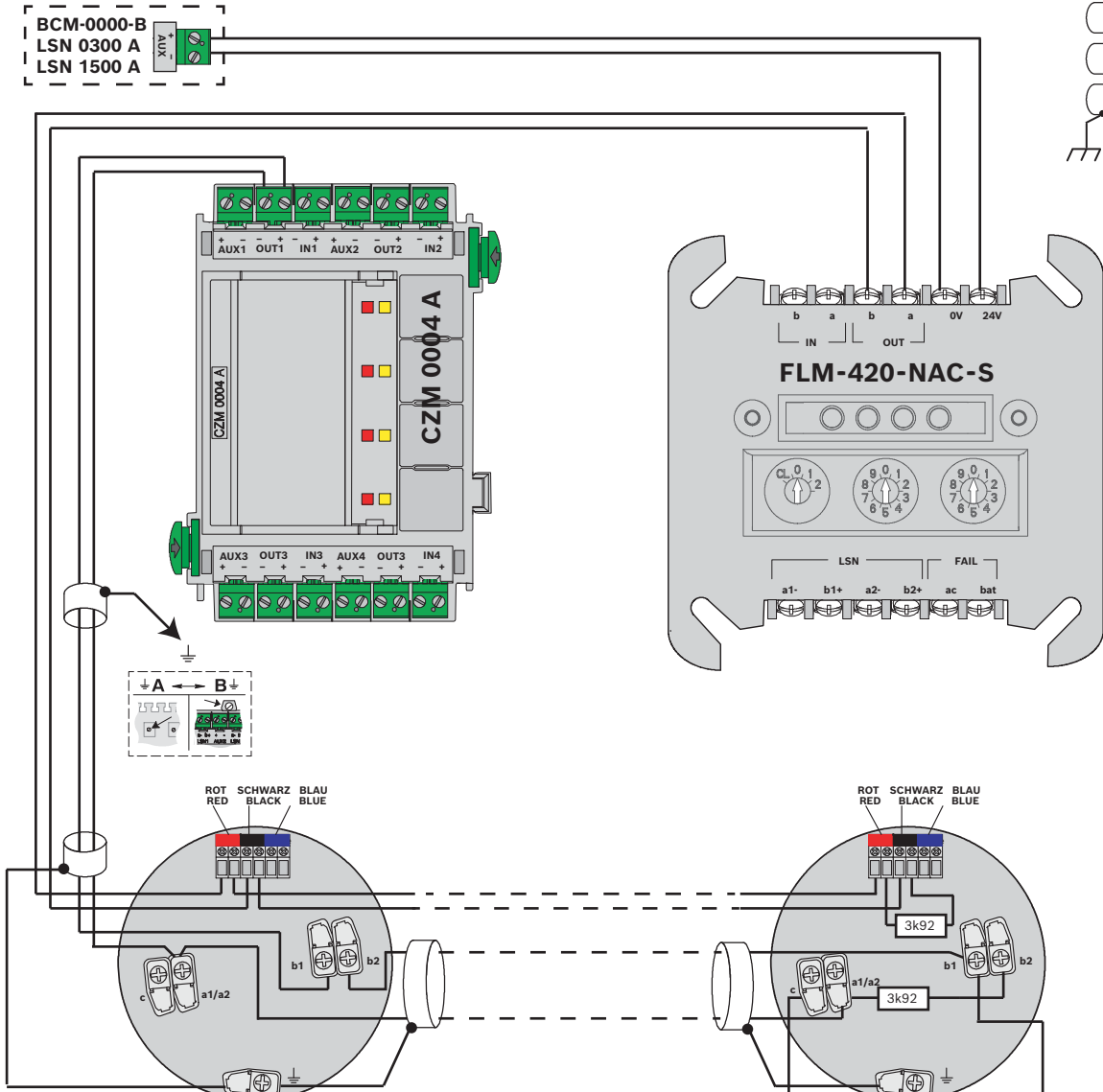
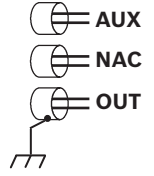

MSS 300-WH-EC

MSS 300-WH-EC

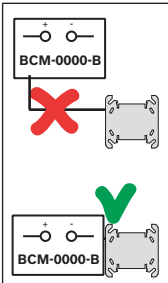

FAA-420-RI-DIN

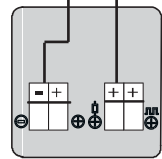

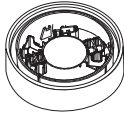

MSS 300-WH-EC
 FCH-T320, FCH-T320-FSA,
 FCH-T320-R470
 FCP-O320, FCP-O320-R470
 FCP-OC320, FCP-OC320-R470
 FCP-OT320, FCP-OT320-R470

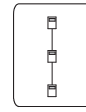

ELS

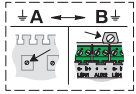
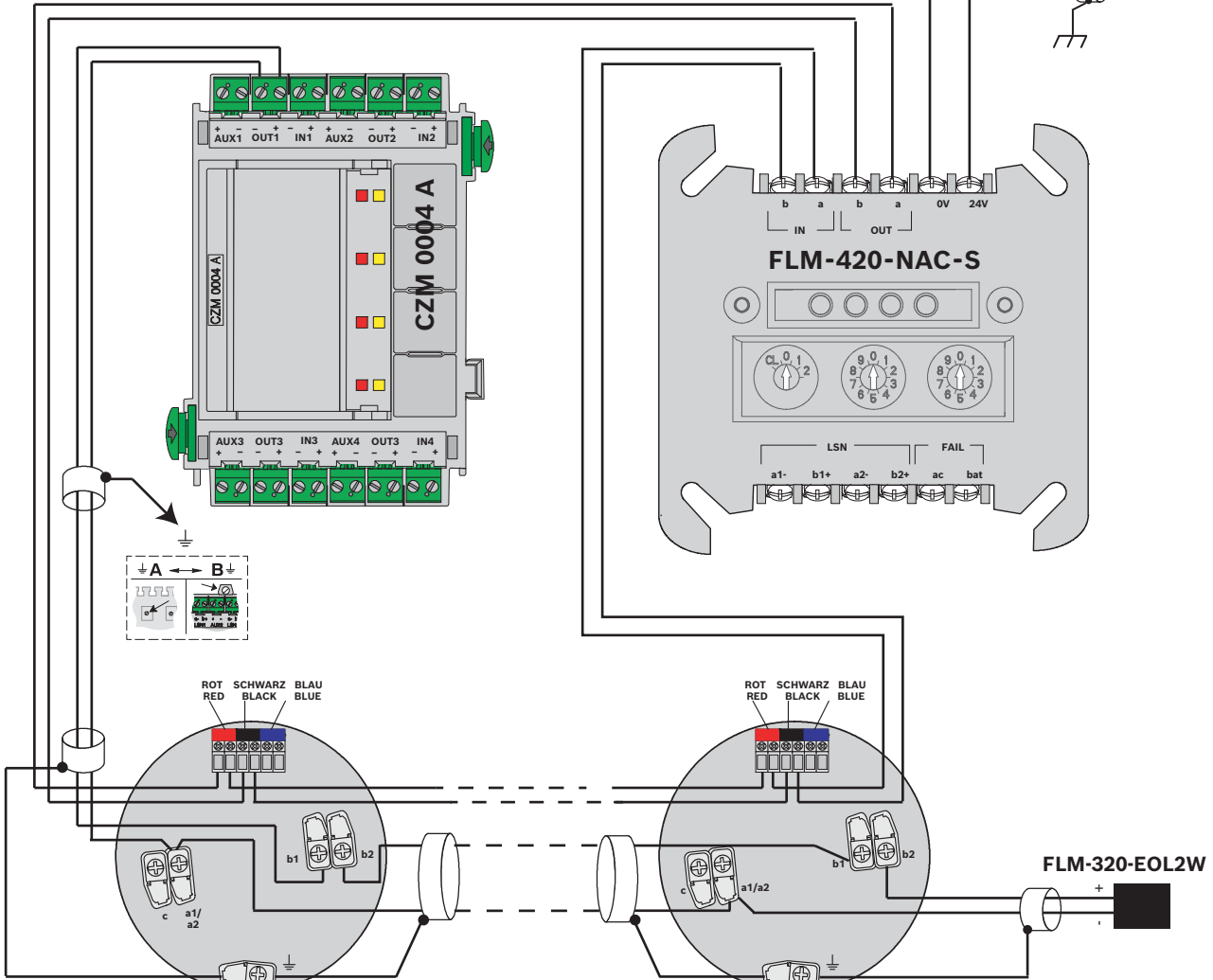
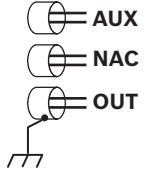
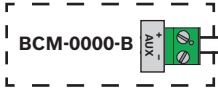

ROT SCHWARZ BLAU
 RED BLACK BLUE

ROT SCHWARZ BLAU
 RED BLACK BLUE

MSS 300-WH-EC

MSS 300-WH-EC

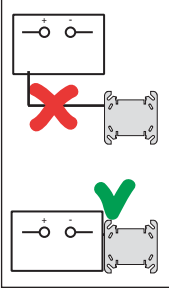

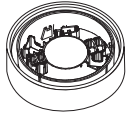

MSS 300-WH-EC
FCH-T320, FCH-T320-FSA,
FCH-T320-R470
FCP-O320, FCP-O320-R470
FCP-OC320, FCP-OC320-R470
FCP-OT320, FCP-OT320-R470

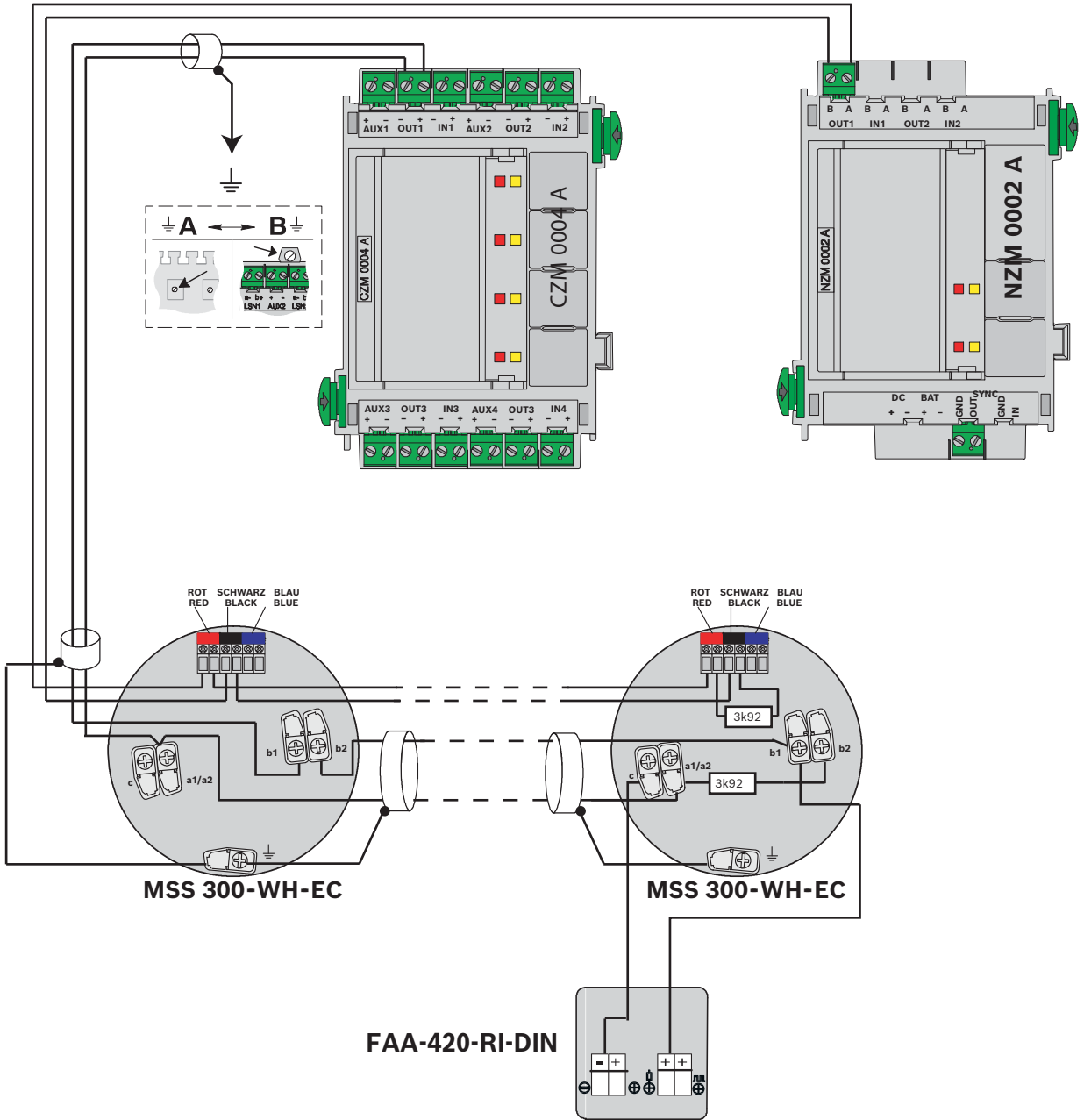
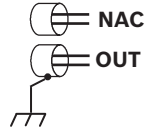
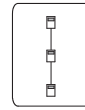



FCA-500-EU
 FCP-O 500
 FCP-O 500-P
 FCP-OC 500
 FCP-OC 500-P

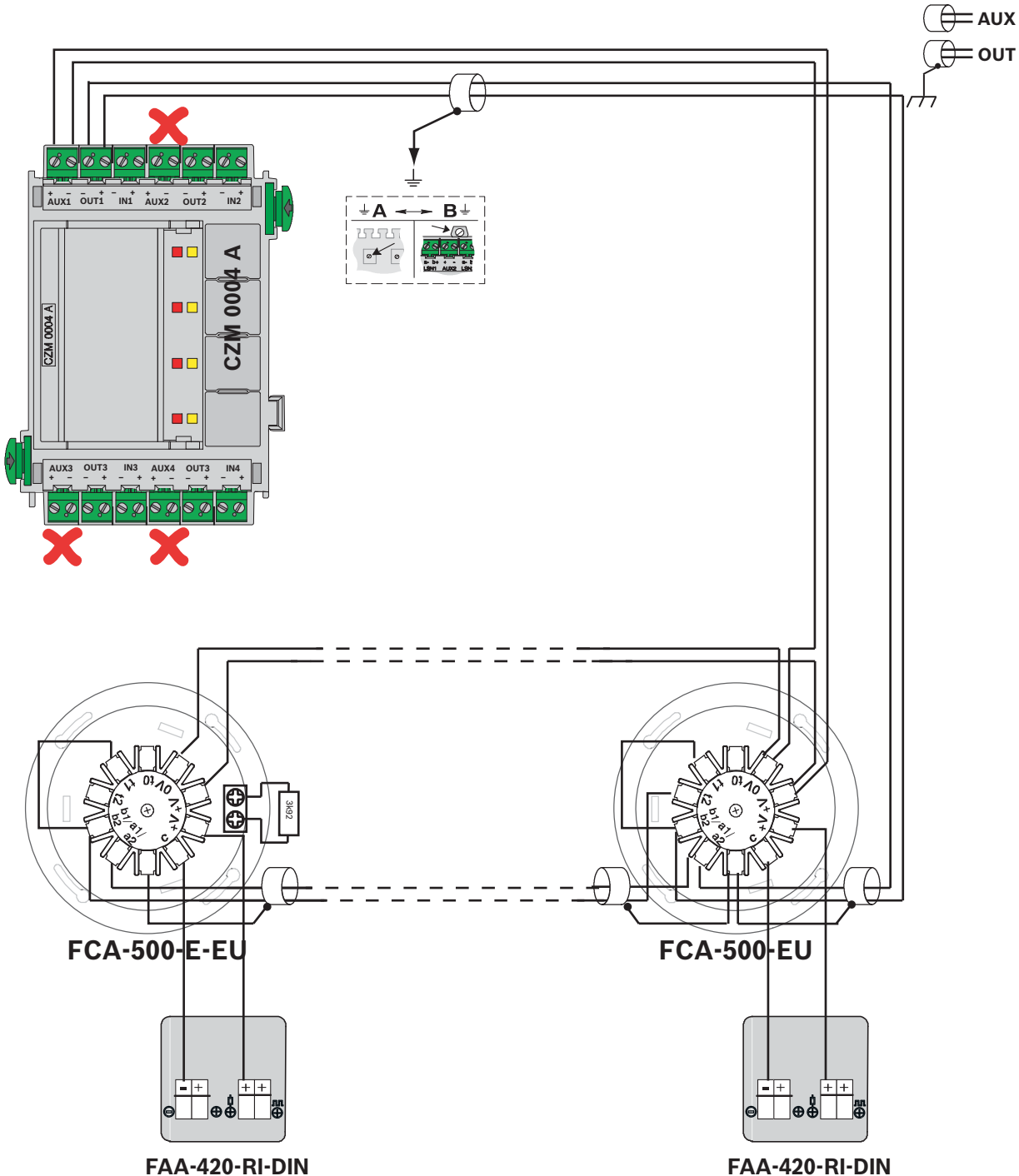
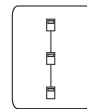

FCA-500-E-EU

FCA-500-EU

FAA-420-RI-DIN

FAA-420-RI-DIN

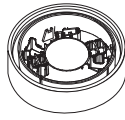

MSS 300-WH-EC
 FCH-T320, FCH-T320-FSA,
 FCH-T320-R470
 FCP-O320, FCP-O320-R470
 FCP-OC320, FCP-OC320-R470
 FCP-OT320, FCP-OT320-R470

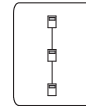

ELS

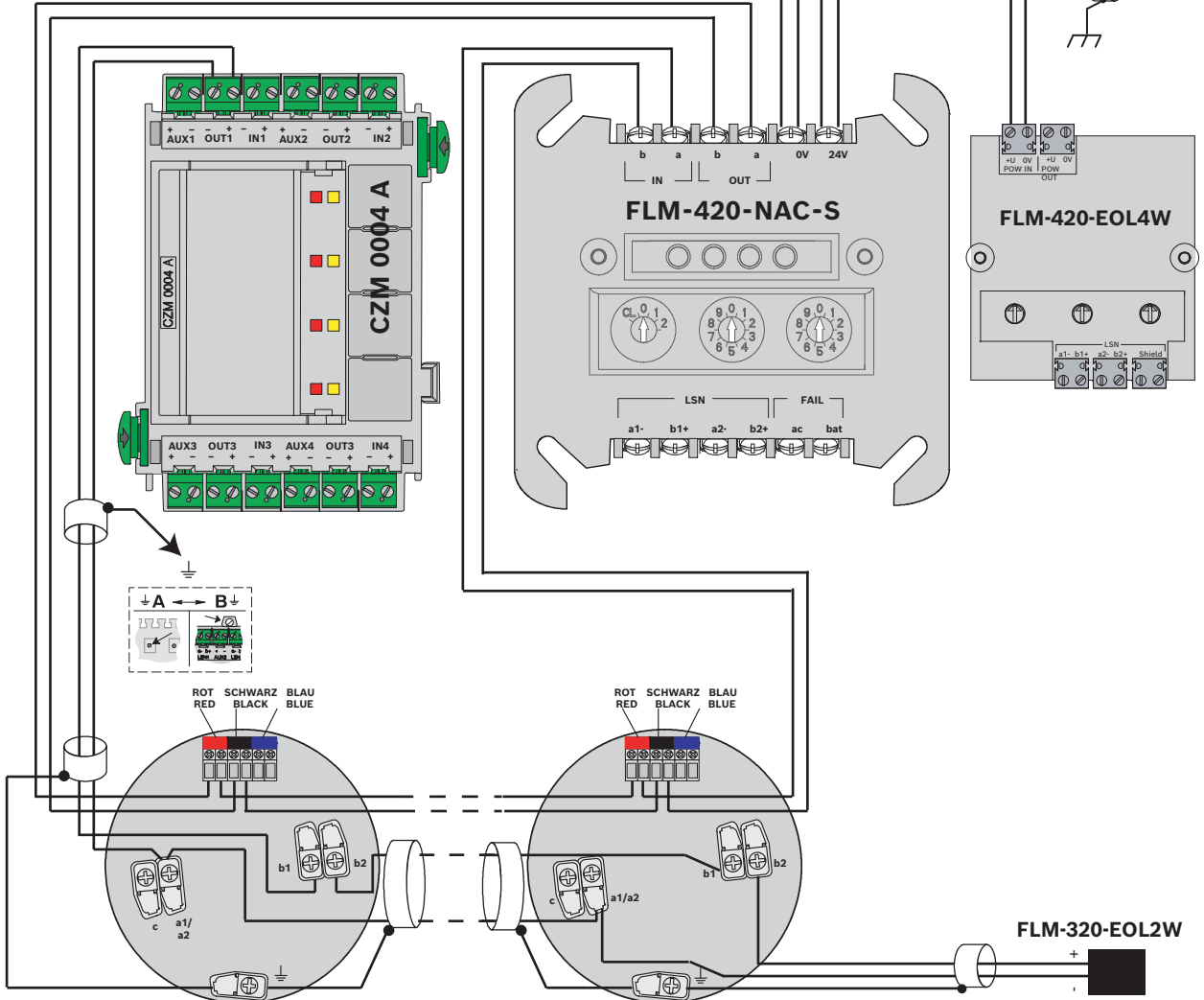
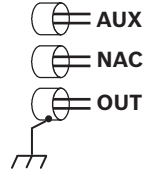
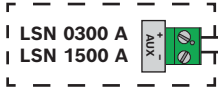

MSS 300-WH-EC

MSS 300-WH-EC

FLM-320-EOL2W